



An Increased-Sensitivity Micro Volt-Ammeter Using A Photoconductive Chopper

TWO OF THE paramount considerations in designing a dc microvoltmeter are minimizing noise so that high sensitivity can be obtained and then achieving freedom from drift on the resulting sensitive ranges. In general, freedom from drift is usually sought by using mechanical choppers to permit an ac-coupled amplifier to be used, while low noise is sought by heavily restricting the bandwidth of the amplifier. Using mechanical choppers is expensive, however, and often introduces other sources of noise into the amplifier. In addition and more important from a measurement standpoint, if line frequencies are used to drive the chopper, as is almost always the case, the measurements are susceptible to large errors when line-frequency hum is present in the dc voltage or current being measured.

The new dc micro volt-ammeter shown in Fig. 1 achieves higher sensitivity and lower drift than established designs by using a non-

mechanical chopper consisting of long-life photoconductor elements. The modulator is operated at other than line frequency so that extremely low effect from 60- and 120-cycle ripple in the measured dc is obtained. Negligible zero drift is obtained by meticulous attention to overall design, while calibration is stable and accurate because of feedback. The resulting instrument has a maximum full-scale voltage sensitivity of ± 10 microvolts and a full-scale current sensitivity of ± 10 micro-microamperes combined with a high input impedance for voltage measurements and a drift of not more than 2 microvolts per hour. Under usual operating conditions, drift is less than 1 microvolt over a period of several hours. The instrument also has a floating input, a factor that has special advantages in the microvolt region, as described later.

The basic power sensitivity of the instrument is better than 10^{-18} watt, which, for an

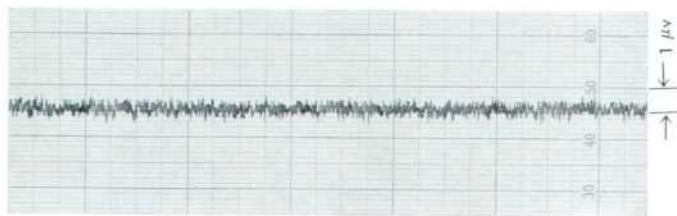
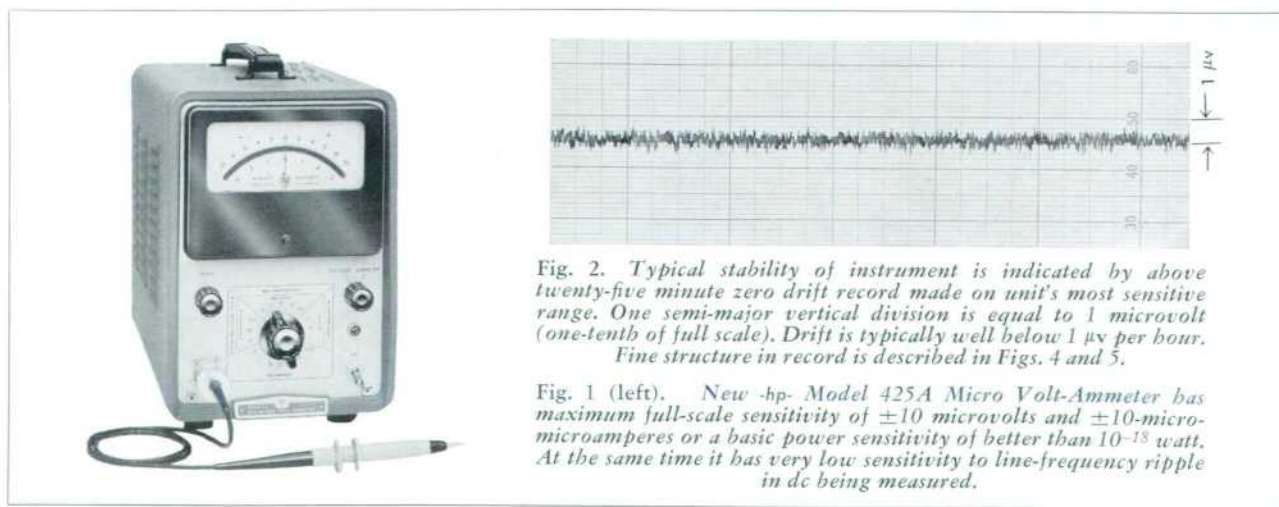

Fig. 2. Typical stability of instrument is indicated by above twenty-five minute zero drift record made on unit's most sensitive range. One semi-major vertical division is equal to 1 microvolt (one-tenth of full scale). Drift is typically well below 1 μ v per hour. Fine structure in record is described in Figs. 4 and 5.

Fig. 1 (left). New -hp- Model 425A Micro Volt-Ammeter has maximum full-scale sensitivity of ± 10 microvolts and ± 10 -micro-microamperes or a basic power sensitivity of better than 10^{-18} watt. At the same time it has very low sensitivity to line-frequency ripple in dc being measured.

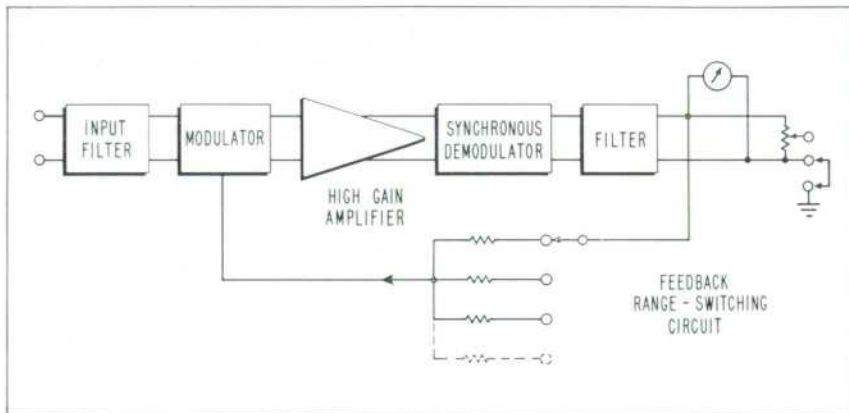

Fig. 3. Basic circuit arrangement of hp Model 425A Micro Volt-Ammeter.

acceptable speed and noise level, is an advance in the art for a high-impedance instrument. In voltage and current terms, a dc measuring instrument capable of measuring 10 microvolts or 10 micro-microamperes full scale increases the measurement threshold for many phenomena. In the electrical field it is valuable for measuring strain gage and thermocouple potentials, IR drops in conductors and switch and relay contacts, minute currents such as grid, photomultiplier and ionization gage currents, and very large resistances. It is also valuable for measuring potentials in both animal and plant biology as well as other chemical potentials.

CIRCUIT ARRANGEMENT

The basic circuitry of the instrument is indicated in Fig. 3. From an operational standpoint the modulator can be considered as a chopper that alternately connects and disconnects the amplifier input from the dc source being measured at a 50 cps rate. Following the modulator is a five-stage amplifier with a basic gain of 140 db. Selectivity corresponding to a Q of about 10 is incorporated in the amplifier to limit noise to well below the saturation level of the later amplifier stages.

The amplifier is followed by a synchronous demodulator similar to the modulator and by a selective filter which gives the overall instrument

a frequency range of from dc to about 0.2 cps in the highest gain position. Overall feedback of at least 30 db in the highest gain position and more on lesser gain positions makes the system essentially independent of tube and line voltage effects. Output terminals in parallel with the metering circuit permit the instrument to be used as a dc amplifier with an output of 1 volt and with a maximum gain of 100 db in the most sensitive position.

To avoid disturbance of the input circuit, range changing is accomplished by varying the return gain in the amplifier feedback circuit. Eleven voltage ranges provide for measurements from ± 10 microvolts full scale to ± 1 volt full scale; 18 current ranges provide for measurement from $\pm 10 \mu\mu\text{a}$ full scale to ± 3 ma full scale. All ranges are related in a 1-3-10 sequence.

BASIC SENSITIVITY CONSIDERATIONS

The use of a 50-cps carrier frequency for the amplifier combined with a narrow bandwidth makes the amplifier practically insensitive to 60- or 120-cycle voltages in the dc circuit being measured. To produce an observable offset on the meter, such voltages have to be large enough to saturate the amplifier. In

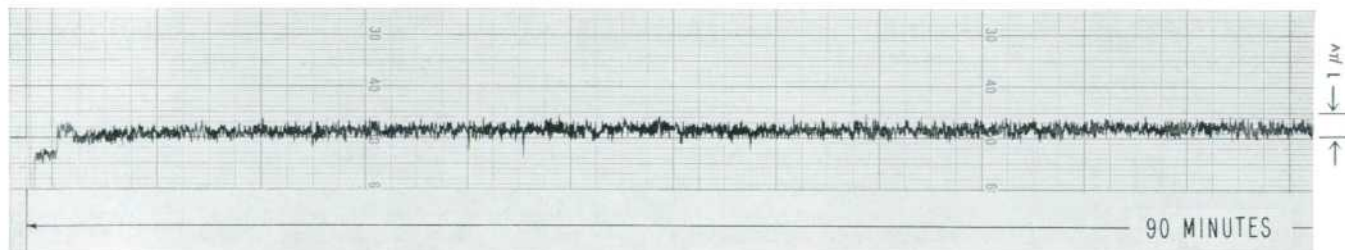

Fig. 4. Typical warm-up drift characteristic of most sensitive range (10 μv full scale). One semi-major vertical chart division equals 1 microvolt. Large transient at left of records in both Figs. 4 and 5 is instrument turn-on transient. Steps in first two minutes of record are initial zero adjustments. Fine structure is noise which is basic sensitivity limitation of instrument and is rated as being less than 0.2 microvolt rms. In a record such as this, noise appears worse than when watching meter

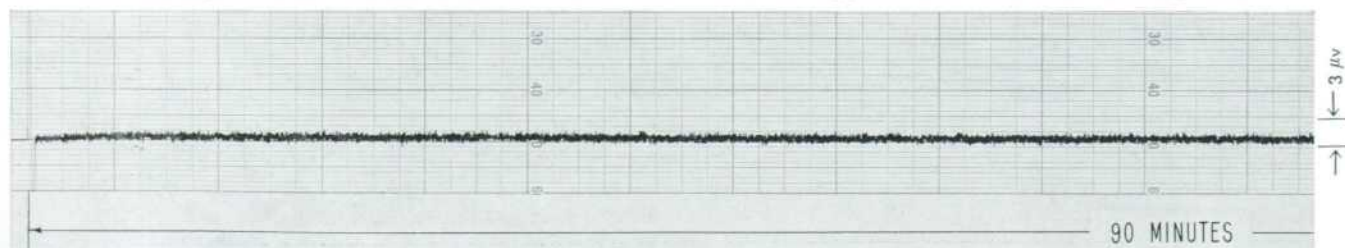

Fig. 5. Typical warm-up drift characteristic similar to that of Fig. 4 except on second most sensitive range (30 μv full scale).

practical terms this means that 60-cps signals have to be well above 50 db above full scale on the three most sensitive ranges. Even a 50 cps signal, should it be encountered, has to be considerably larger than full scale in order to cause appreciable error, since the input filter has its maximum rejection at that frequency.

These considerations result in the fact that the chief limitation on sensitivity for the instrument is thermal noise in the input circuit. Assuming an equivalent noise bandwidth for the system of 1 cycle, the thermal noise from resistance in the input circuit calculates to about 0.06 microvolt rms, while flicker noise referred to the input is about 0.03 microvolt rms. Total random noise referred to the input is thus of the order of 0.1 microvolt. This agrees well with observed results (see Fig. 4), and the instrument is rated as having less than 0.2 microvolt rms noise reading.

STABILITY

The performance of the instrument is perhaps best summarized by the curves shown in Figs. 4 to 6. Figs. 4 and 5 show warmup drift on the 10 microvolt and 30 microvolt ranges at room temperature. Typical noise readings are also visible on the records. On the 100 microvolt range

Fig. 6. Typical effect of large line voltage changes on most sensitive range (10 μ v full scale). Effect is small but diminishes proportionately as range values are increased.

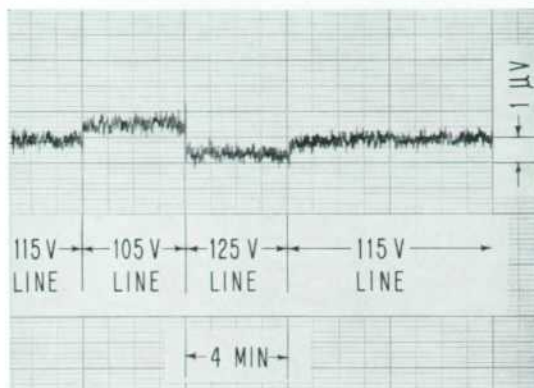

noise readings are almost undetectable. The record is arranged so that one semi-major chart division corresponds to one major division on the meter face, i.e., 1 microvolt in Fig. 4 and 3 microvolts in Fig. 5.

Typical line voltage effects on zero shift are indicated in Fig. 6 for a ± 10 -volt change from 115 volts on the most sensitive range.

FLOATING INPUT

The instrument is designed with an isolated chassis which can be grounded to the cabinet if desired by means of a grounding link at the back. The isolated chassis, however, permits the instrument to be used to measure off-ground voltages such as small differences between large dc voltages, since the chassis can be operated with up to 400 volts between

chassis and cabinet. The output terminals on the rear further permit the instrument to operate a recorder for making drift records in such voltage sources.

INPUT IMPEDANCE

Basically, the instrument has a very high input impedance in excess of 50 megohms. In order to have a fixed input impedance to shunt for current measuring purposes, a 1 megohm resistor is placed internally across the input terminals, giving the instrument a 1 megohm input resistance on voltage measurements. If a high impedance of 50 megohms or more is desired, this resistor can be omitted at the factory. Current measurements on the more sensitive ranges will then require either placing an accurate 1 megohm resistor

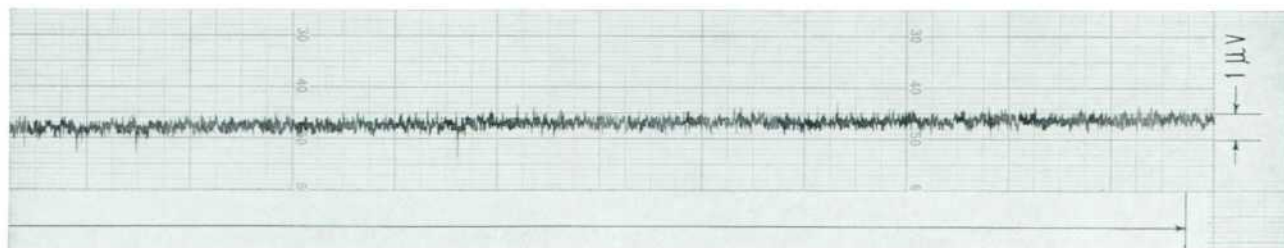

(Fig. 4 continued)

pointer, since in a record the eye tends to follow peak values while in a meter the eye tends to see the short term average value of the meter fluctuations which varies only about one-sixth as much as peak value. In any case noise is small enough and stability high enough that readings can be made to about 0.1 microvolt. Noise deflection diminishes, of course, as range values are increased (Fig. 5).

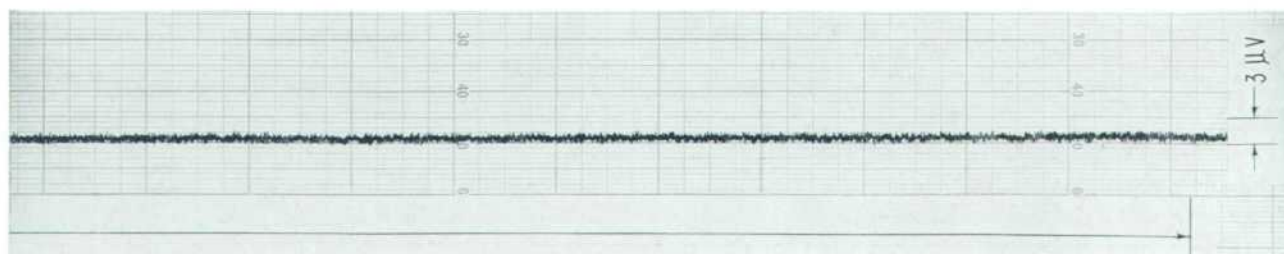

(Fig. 5 continued)

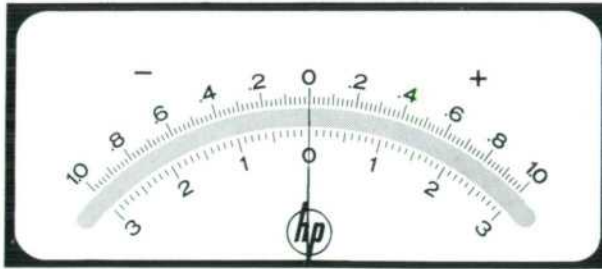

Fig. 7 (left) Zero-center meter scales (here reproduced approx. 60% of full size) are related in 1 - 3 - 10 sequence. Meter scale is mirrored.

across the terminals or making measurements in terms of the IR drop across another known resistance.

The input resistance on current measurements varies from 1 megohm on the most sensitive ranges to 0.33 ohm on the least sensitive 3 ma range and is listed elsewhere herein.

OVERLOAD PROTECTION

The input circuit is arranged with a small gas tube which fires at about 70 volts to protect the instrument from accidental momentary application of voltages up to 1,000 volts between the terminals.

INSTRUMENT PROBE

The instrument design includes a special probe for connecting to the source to be measured. The probe is constructed in penholder style with clips operated by flanges on the probe body. The clips themselves are formed from metal that has a low thermal emf value to copper, the standard metal for measurement purposes.

RESPONSE AND METER DATA

The indicating meter is a large 6" zero-center type which is provided with high readability scales, as shown in Fig. 7. The movement includes a mirror scale for minimizing parallax.

For all but the most sensitive range, the response time of the instrument is essentially that of the meter movement itself which is a fraction of a second. On the most sensitive range, response time is about 2 seconds. On any range overshoot is negligible.

MEASUREMENT CONSIDERATIONS

Measuring voltages in the microvolt region often involves phenom-

ena which are given little consideration in other work. The main effect of these factors is that unrealized voltages will be included in the measurement. Ground currents flowing in a system under measurement, for example, can readily raise the potential at one point of a metallic ground from 10 to 100 microvolts above another point in a typical case.

Circuits involving capacitors bring into effect the matter of dielectric absorption. Most capacitors will retain portions of a charge for intervals from minutes to days and can thus introduce voltages which may need consideration.

Thermoelectric effects also introduce voltages of sizable proportions

in this region. Similarly, electrochemical effects, although probably less common than the effects named above, can occur in surprising ways. Insulators such as phenolic types can produce galvanic emf's when used to support metallic studs or terminals and thus introduce error voltages into sensitive measurements.

For many of these cases the floating input of the instrument is valuable, since it enables the full sensitivity of the instrument to be used in measuring the magnitude of these effects, either in accounting for difference measurements or in specific investigation of such emf's.

ACKNOWLEDGMENT

Appreciation is expressed to the people who have been helpful during the development of this instrument. John Lark and Harold Rocklitz have carried the brunt of the design assignment, and the development of the photo-conductor by Dr. H. E. Overacker's group has made the instrument possible.

—John M. Cage

SPECIFICATIONS

-hp-

MODEL 425A

DC MICRO VOLT-AMMETER

DC Voltage Ranges: Eleven zero-center ranges in a 1-3-10 sequence with following full scale positive and negative values:

±10, 30, 100, 300 microvolts;
±1, 3, 10, 30 millivolts;
±0.1, 0.3, 1 volt.

Input Impedance on Voltage Ranges: 1 megohm ±2%; determined by input resistor which can be removed to provide input Z in excess of 50 megohms.

DC Current Ranges: Eighteen zero-center ranges in a 1-3-10 sequence with following full scale positive and negative values:

Range	R in	V Drop
±10 μA	1 m	10 μV
±30 μA	1 m	30 μV
±100 μA	1 m	100 μV
±.3 mA	1 m	.3 mV
±1 mA	1 m	1 mV
±3 mA	333 k	1 mV
±10 mA	100 k	1 mV
±30 mA	33 k	1 mV
±.1 μA	10 k	1 mV
±.3 μA	3.3 k	1 mV
±1 μA	1.0 k	1 mV
±.003 mA	333 ohms	1 mV
±.01 mA	100 ohms	1 mV
±.03 mA	33 ohms	1 mV
±.1 mA	10 ohms	1 mV
±.3 mA	3.3 ohms	1 mV
±1 mA	1.0 ohm	1 mV
±3 mA	.33 ohm	1 mV

Accuracy: ±3% exclusive of noise and drift specified below.

Frequency Range As An Amplifier: DC to approx. 0.2 cps (3 db point) on 10 μV or 10 μA range. DC to approx. 1 cps on higher ranges.

Max. Output of Amplifier: Adjustable, 0-1 volt dc.

Output Impedance: 5,000-ohm pot across internal impedance of 10 ohms or less.

Max. Voltage Gain as an Amplifier: 100 db.

Noise at Output Terminals or on Meter: Less than 0.2 μV rms referred to input terminals.

Drift: Less than 2 μV per hour after 15 minute warmup.

Input Isolation: Input terminals are floating and can be connected in common up to 400 volts from ground; input protected from accidental application of up to 1,000 volts across input; grounding link provided at rear for grounding one side to chassis if desired. Ground side of output is common with ground side of input.

Power: Operated from 115 volts ±10 volts, 60 cps; requires approx. 40 watts.

Dimensions: Cabinet mount: 7 1/2" wide, 11 1/4" high, 14" deep. Rack mount: 19" wide, 7" high, 10 3/4" deep.

Weight: Cabinet mount, 18 lbs.; rack mount, 20 lbs.

Shipping Weight: Cabinet mount, 24 lbs.; rack mount, 28 lbs. (approx.)

Price: Model 425A cabinet mount, for 60-cps line operation, \$500.00.

Model 425AR rack mount, for 60-cps line operation, \$505.00; for 50-cps line on special order.

Prices f.o.b. Palo Alto, California.

Data subject to change without notice.