



## The 700-Megacycle Voltmeter and Its Applications

THE single measurement most useful and most often made in communications engineering is the measurement of voltage. At high frequencies, where distributed constants can significantly modify circuit voltages, measurements of voltage become even more useful. The high-frequency voltmeter, then, is an instrument of considerable importance.

Prime requirements for a high-frequency voltmeter are high input resistance with a minimum of shunting capacity. The latter is especially important, as illustrated by the fact that at 100 mc the reactance of 10 mmf is only 160 ohms. This means that not only must the voltmeter itself have low input capacity but that it must be capable of being connected into the circuit without introducing significant stray capacity.



Figure 1. New -hp- Model 410B High-Frequency VTVM supersedes widely-used Model 410A. In addition to electrical improvements, the instrument has been completely redesigned mechanically. Leads are stored in compartment at back of cabinet.

The -hp- Model 410 High Frequency VTVM is designed to have low input capacity—approximately 1.5 micromicrofarad. The input resistance is in excess of 10 megohms at low frequencies, falling off as frequency increases. The frequency range of the voltmeter is from 20 cps to 700 mc, although measurements can be made at higher frequencies with reduced accuracy. For example, voltage indications can be obtained at frequencies above 3000 mc. The a-c voltage range of the voltmeter is from 1 volt full scale to 300 volts full scale in six ranges. The -hp- Model 410 is designed primarily as an a-c voltmeter, although it is also an ohmmeter and a high-quality d-c voltmeter having an input resistance of approximately 120 megohms.

The new Model 410B voltmeter described herein is an improved design of the popular Model 410A which was first brought out in 1946. In the new design, better long-time stability has been achieved and the balancing tube for the probe diode has been eliminated. Hence, the new circuit does not require a matched pair of diodes. As a result, a higher percentage of diodes than heretofore is usable and the user's replacement cost for tubes is less. Other advances in the new design include elimination of dry cells from the ohmmeter circuit and the use of a more stable d-c amplifier with fewer tube types. *The Model 410A has now been discontinued and orders for it are being filled with the improved Model 410B at no increase in cost.*

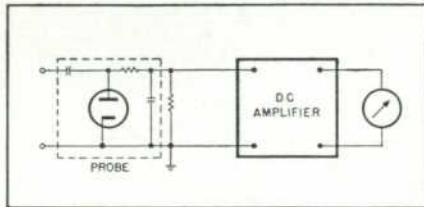

Figure 2. Diagram of high-frequency voltmeter circuit.

#### CIRCUITRY

The circuit of the -hp- Model 410 voltmeter consists of a broad-band rectifier, a d-c amplifier, and an indicating meter (Figure 2). The design of the voltmeter can be divided into two separate problems: the design of a rectifier tube and associated circuitry having the widest possible frequency range, and the design of a stable d-c amplifier.

If the rectifier tube is to be capable of operation up to very high frequencies, it is necessary that it have short transit time and low anode-cathode capacity. A diode\* with these characteristics was developed especially for the Model 410. This diode is constructed with plane geometry; the anode opposes rather than surrounds the cathode as in the more conventional cylindrical geometry. The anode itself is a 0.060-inch diameter rod spaced only 0.010-inch

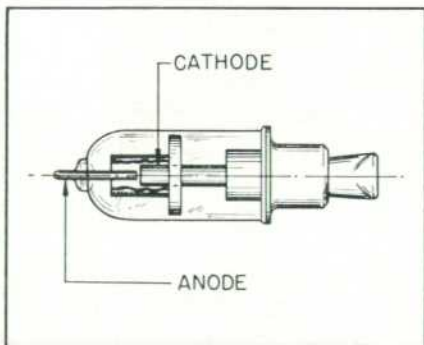

Figure 3. Full size drawing of high-frequency diode used in Model 410.

from the 0.125-inch diameter cathode. The close spacing keeps transit time short while the small opposing surface areas keep the capacity low (about 0.3 mmf). To minimize inductances, the overall length of the

\*Developed by Eitel-McCullough, Inc.

tube has been held to 1.7 inches.

A cutaway view of the probe showing the rectifier diode and circuitry is illustrated in Figure 4. In the design of the probe, every effort has been made to minimize lead length and capacity. The r-f path from the tip of the input lead to the cathode connection at the base of the tube is only 2½ inches long, yet the anode circuit is well-isolated from the ground plane existing at the lower part of the probe. At the same time the lower part of the probe has been completely enclosed with a grounding shell to aid the establishing of a reliable ground at high frequencies. These design considerations have resulted in the rectifier tube and its circuitry having a resonant frequency of approximately 1500 megacycles.

A performance curve for the probe showing the ratio of output d-c to input a-c as a function of frequency is plotted in Figure 5(a). At low and medium frequencies, the response is quite constant. At high frequencies, however, the response is affected by two factors: transit time, which is dependent upon the magnitude of the applied voltage; and the resonant frequency of the probe, which is independent of the applied voltage. The effect of transit time is indicated by the dip in the 1-volt curve in the vicinity of 500 mc. The rise of the 3-volt and 10-volt curves is attributable to the resonant frequency of the probe and its effects that overshadow the transit time effect.

The input resistance and shunt capacitive reactance components are shown in Figure 5(b). At low frequencies the input resistance is in excess of 10 megohms, decreasing at higher frequencies because of dielectric and tube losses and because of high-frequency effects in resistors. The shunt capacity component of input impedance is approximately 1.5 mmf.

The d-c amplifier used in the new Model 410B is a redesign of the for-

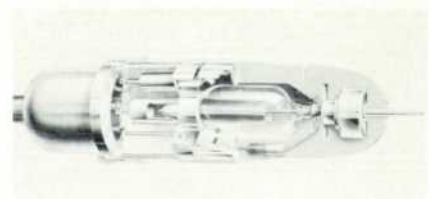

Figure 4. Cutaway view of high-frequency probe.

mer amplifier to provide higher stability. The amplifier used is shown in basic form in Figure 6. Twin triodes make use of the similarity of characteristics that occur in twin-type tubes, thus minimizing tube matching problems. In design acceptance tests, the new amplifier operated within specifications on more than 80% of randomly-selected tubes, while more than 50% of randomly-selected tubes gave less than a ½% change in the gain of the amplifier for a ±10-volt line voltage change.

#### BALANCE DIODE ELIMINATED

One of the problems in achieving good overall stability for the voltmeter circuit is minimizing the effects of changes in line voltage on the characteristics of the high-frequency diode. When no measurement voltage is applied to the input of the probe and the diode is thus without anode voltage, some elec-

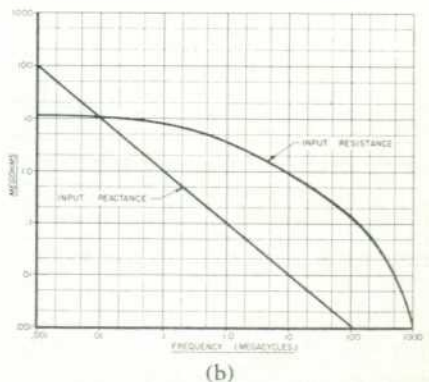
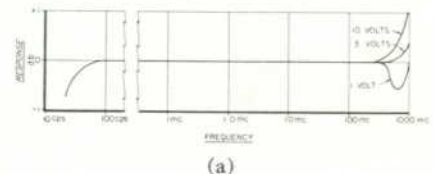

Figure 5(a). Response of high-frequency rectifier. (b) Input resistance and reactance of Model 410.

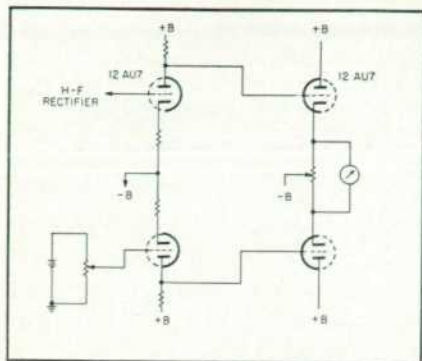

Figure 6. Basic d-c amplifier circuit used in Model 410B.

trons from the cathode still pass to the anode, transferring energy to the anode and raising its potential about a volt. This voltage is related to the diode filament voltage, for changes in filament voltage will change the velocity with which electrons are emitted from the cathode. Thus, this "emission voltage" varies with line voltage changes and is sufficiently large to mask small measurement voltages.

To compensate this effect, it has been customary to use a balanced type d-c amplifier in which one channel operates from the high-frequency rectifier and the other channel operates from a balancing diode that has been matched to the characteristics of the rectifier diode. Through this arrangement, the effects of "emission voltage" and diode filament voltage changes were nullified as far as their effect on the meter readings were concerned.

In the new Model 410B, it was desired to simplify tube replacement by eliminating the balance diode. In the final circuit, only the probe diode is used. To minimize the effect of line voltage variations on this diode, the heater circuit is regulated by a ballast element, thus maintaining the diode "emission voltage" constant. The "emission voltage" is then compensated by connecting the balance channel of the d-c amplifier to a regulated d-c voltage. This arrangement has resulted in a high order of stability. For example, the zero-point drift in design acceptance

tests was less than 2% over three-day intervals. From the stand-point of tube replacement, then, the only adjustment required when replacing the diode is to zero-set the meter pointer with the panel control.

#### HIGH FREQUENCY USAGE

Voltage measurements at high frequencies can be divided into two types—those where the voltage is confined to coaxial transmission lines and those involving open circuits such as the wiring in a high-frequency amplifier. The latter type is not often encountered at frequencies above 150 megacycles.



Figure 7. -hp- Model 455A "T" connects voltmeter probe across coaxial transmission line.

To measure voltages in coaxial lines, the Model 455A "T" and the Model 458A "N" adapter have been developed. The "T" allows measurement or monitoring of the voltage in a transmission line and is useful beyond 1000 mc for this purpose. The device consists of a section of transmission line with provision for connecting the probe of the voltmeter across the line. The "T" can be connected into a nominal 50-ohm line without serious disturbance, for the VSWR introduced by it is less than 1.1 below 1000 mc. One male and one female type "N" connector are provided on the "T."

The Model 458A "N" adapter connects the probe of the voltmeter to a female type "N" connector and makes possible the measurement of open-circuit voltages for such purposes as indicating voltage, alignment, peaking, etc. No terminating



Figure 8. -hp- Model 458A "N" adapter connects voltmeter probe to open end of coaxial line.

resistance is incorporated into the adapter.

In circuits where the voltage paths are accessible, the type of construction used in the probe enhances measurement accuracy. The probe is constructed so that the input blocking capacitor can be removed by unscrewing the probe nose piece in which the capacitor is molded. In high-frequency measurements, then, a small button-type capacitor can be soldered to the point of measurement and the probe end held against the capacitor. This procedure shortens the length of the measurement circuit and at the same time reduces stray capacity to the lowest realizable value. Measurements with this procedure are practical up into the region of several hundred megacycles, but at higher frequencies distributed constants will ordinarily restrict measurements to coaxial transmission line voltages.

#### OTHER ACCESSORIES

In addition to the "T" and "N" adapters described above, a 25-kilovolt divider and a 2000-volt divider for a-c voltages have been designed. For measuring very high d-c voltages, a 30-kilovolt d-c multiplier is available.

The -hp- 452A 25-kilovolt Capacitive Divider permits measurement of extremely high a-c voltages such as are encountered in dielectric heating equipment and similar applications. The frequency range of the divider is from 25 cps to 20 mc, although as frequency increases the divider is de-rated to limit the r-f current flowing through its capacitors. A fixed gap is provided so that breakdown will occur if the applied voltage exceeds about 28 kv.

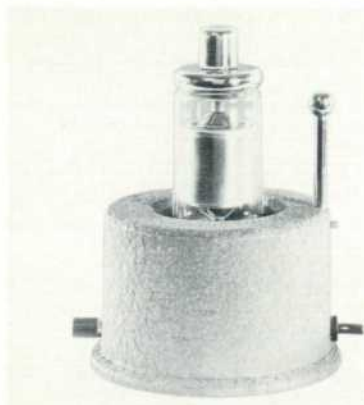

Figure 9. -hp- Model 452A Divider permits measurement of voltages up to 25 kv a-c.

The -hp- 453A 2,000-volt a-c Divider fits directly over the voltmeter probe. The nominal low frequency limit of the divider is 10 kc, but it can be used at much lower frequencies by the use of a standard correction curve that is supplied with each divider. For example, the error at 500 cps is only about 5% and can be corrected by the standard curve.

For measuring high d-c voltages such as in television receivers and other equipment using cathode-ray tubes, the -hp- 459A DC Voltage Multiplier is very useful. This multiplier permits measurements up to 30,000 volts d-c and increases the input resistance of the voltmeter to 12,000 megohms; hence, only 2.5



Figure 10. -hp- Model 453A Divider permits measurement of voltages up to 2000 volts a-c.

microamperes are drawn from a 30 kv circuit. The multiplier is built in the form of a long probe and includes a hand guard to minimize the danger of accidental physical contact with high-voltage circuits.

Where it is desirable to monitor the output of the -hp- 460 Wide



Figure 11. -hp- Model 459A Multiplier permits measurement of voltages up to 30,000 volts d-c.

Band Amplifier (150 mc), the -hp- 46A-95D Adapter can be used with the Model 410 voltmeter. This adapter (not illustrated) connects the probe of the Model 410 to the output of the amplifier and is compensated so that measurements can be made up to 200 mc.

-J. R. Petrak

## Diode Replacement Kit Available For Model 410A

One of the major circuit improvements in the new Model 410B is the elimination of the balance diode from the circuit. To make this same improvement available to users of the Model 410A, a replacement kit has been prepared. This kit is offered at the same price as that of a single high-frequency diode and will eliminate future need for using matched pairs of diodes.

The kit is offered in the form of a small built-up chassis that can be installed in Model 410A's having serial numbers higher than 200. The chassis mounts on spade lugs that are already present in the Model 410A so that no holes need be drilled. The five leads on the chassis can be easily connected. Each kit is supplied with illustrated instructions.

Electrically, the chassis consists of a current regulator circuit for the probe diode together with a rectifier circuit for balancing out the "emission voltage" of the probe diode.

Use of the modification kit simplifies the replacement of the probe diode and allows a greater percentage of these diodes to be used. The kit should be ordered by its stock number: 42A-95G. The price is \$10.50 f.o.b., Palo Alto, California.

### SPECIFICATIONS FOR -hp- MODEL 410B HIGH-FREQUENCY VTVM

AC RANGES: Six: 1, 3, 10, 30, 100, and 300 volts full scale.

DC RANGES: Seven: 1, 3, 10, 30, 100, 300, and 1000 volts full scale.

RESISTANCE RANGES: Seven: mid-scale values of 10, 100, 1000, 10,000 and 100,000 ohms, and 1 megohm and 10 megohms.

ACCURACY: Within 3% of full scale on all ranges for sinusoidal ac voltages and on dc voltages.

FREQUENCY RESPONSE: Constant within 1 db from 20 cps to 700 mc.

INPUT IMPEDANCE: Input capacity less than 2 mmf; input resistance is 10 megohms or more at low frequencies, decreasing at high frequencies because of dielectric losses.

POWER SOURCE: Operates from nominal 115-volt, 50/60 cycle source; requires approximately 40 watts.

WEIGHT: 16 lbs.; shipping weight, approximately 28 lbs.

Price: \$245.00 f.o.b. Palo Alto, California.

### No. 46A-95D Adapter

For Model 410 voltmeter probe. Consists of a bayonet type sleeve with which a Model 410 probe can be connected directly to the output of a Model 460 Amplifier. Includes proper compensating LC components.

SHIPPING WEIGHT: 1 lb.

PRICE: \$15.00 f.o.b. Palo Alto, California.

### SPECIFICATIONS -hp- MODEL 452A CAPACITIVE VOLTAGE DIVIDER

MAXIMUM VOLTAGE: 25,000 volts ac at low frequencies, decreasing with frequency to 7000 volts at 20 mc.

DIVISION RATIO: 1,000:1.

ACCURACY: Within 3%.

FREQUENCY RANGE: 25 cps to 20 mc.

INPUT CAPACITY:  $15 \pm 1$  mmf.

SHIPPING WEIGHT: Approx. 18 lbs.

PRICE: \$75.00 f.o.b. Palo Alto, California.

### -hp- Model 453A Capacitive Voltage Divider

(Specifically for use with probe of Model 410A or 410B)

MAXIMUM VOLTAGE: 2000 volts ac; above 50 mc the divider is derated to approx. 100 volts at 400 mc.

DIVISION RATIO: 100:1

ACCURACY: Within 1%.

FREQUENCY RANGE: 10 kc to high frequencies; can be used below 10 kc with use of correction curve.

INPUT CAPACITY: Approx. 2 mmf.

SHIPPING WEIGHT: 1 lb.

Price: \$20.00 f.o.b. Palo Alto, California.

### -hp- Model 455A Coaxial "T"

(Specifically for use with probe of Model 410A or 410B)

RESIDUAL VSWR: Less than 1.1 at 500 mc; less than 1.1 at 1,000 mc.

CONNECTORS: Type "N," one male and one female.

SHIPPING WEIGHT: 1 lb.

PRICE: \$35.00 f.o.b. Palo Alto, California.

### -hp- Model 458A "N" Adapter

(Specifically for use with probe of Model 410A or 410B)

CONNECTOR: Mates with female type "N"

SHIPPING WEIGHT: 1 lb.

PRICE: \$17.50 f.o.b. Palo Alto, California.

### -hp- Model 459A DC Voltage Multiplier

(Specifically for use with -hp- Models 410A and 410B)

MAXIMUM VOLTAGE: 30,000 volts dc.

MULTIPLICATION RATIO: 100:1.

ACCURACY: Within 5%.

INPUT RESISTANCE: 12,000 megohms.

SHIPPING WEIGHT: 3 lbs.

PRICE: \$20.00 f.o.b. Palo Alto, California.

Data subject to change without notice.