

~~TOP SECRET~~

8311



NATIONAL SECURITY AGENCY
FORT GEORGE G. MEADE, MARYLAND

CRYPTOLOG

DECEMBER 1974

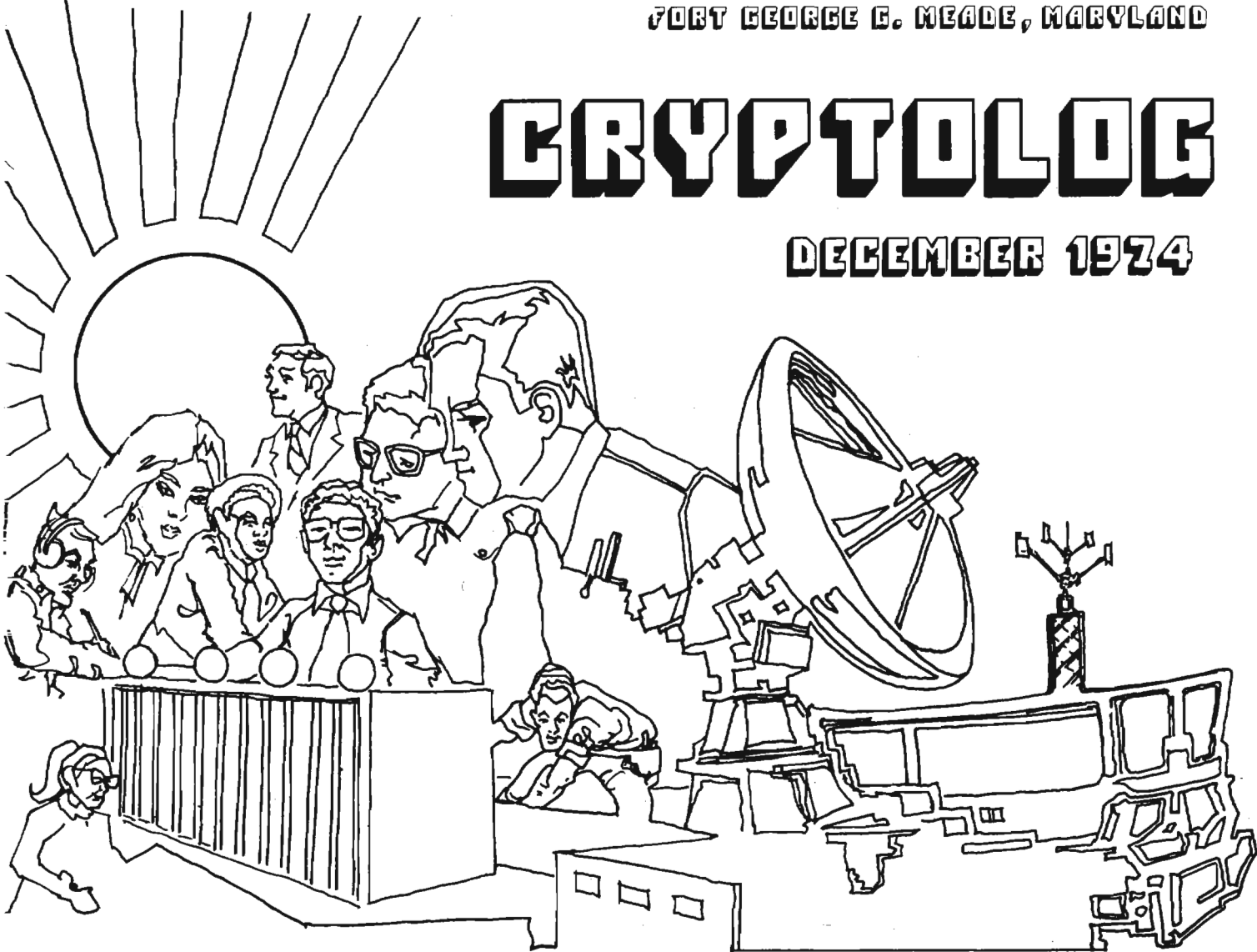

EO 1.4.(c)

P.L. 86-36

MAPS IN MIND: A Photoessay.	[Redacted]	1
THE OLD [Redacted] SECTION (Parts 3 & 4).	[Redacted]	5
AN APPROACH TO CALLSIGN ANALYSIS.	William J. Jackson	7
LETTER TO THE EDITOR.		9
CISI FORMING NEW SIG/Human Factors.	[Redacted]	10
THE NEW COLLECTION CRITERIA	[Redacted]	11
A FLAG-WAVING PROGRAMMER.	George John.	13
A LONG HARD LOOK AT THE INTERN PROGRAM.	Anne Exinterne	14
A PROPOSAL FOR CALENDAR REFORM.	Francis T. Leahy	20
CRYPTOLOG INDEX FOR 1974.		21

Declassified and Approved for Release by NSA on 10-11-2012 pursuant to E.O. 13526, MDR Case # 54778

~~TOP SECRET~~

~~TOP SECRET~~

CRYPTOLOG

Published Monthly by P1, Techniques and Standards,
for the Personnel of Operations

VOL. I. NO. 5

DECEMBER 1974

PUBLISHER

WILLIAM LUTWINIAK

BOARD OF EDITORS

Editor in Chief Doris Miller (5642s)
 Collection..... [redacted] (3571s)
 Cryptanalysis..... [redacted] (8025s)
 Language..... [redacted] (5236s)
 Machine Support..... [redacted] (3321s)
 Special Research..... Vera R. Filby (7119s)
 Traffic Analysis..... William J. Jackson, Jr. (3369s)
 Art Editor..... [redacted]

P.L. 86-36

* * * * *

Editor for DecemberHarry G. Rosenbluh

~~TOP SECRET~~

~~CONFIDENTIAL~~

P.L. 86-36

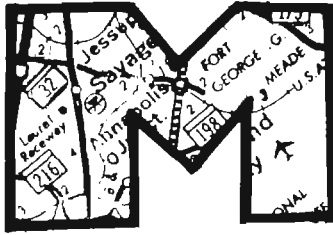

MAPS IN MIND: A PHOTOESSAY

by 

Marshall McLuhan has said that the map is one of a select group of communications media without which "the world of modern science and technologies would hardly exist." Last year the Geography and Map Library in room 2N075 answered 5000 geographic information requests and furnished  maps, charts, and geographic publications to help the employees of the Agency communicate more effectively and to help them adjust to the rapidly changing target areas and international crises which characterize NSA's recent history. For those readers who have never used our services this photoessay should provide an introduction to the selection of maps.

The second major concern in selecting a map is the projection. Projection refers to the method used to put a representation of the earth on to a flat sheet of paper. Maps are usually projected onto cylinders, cones and planes. The following chart shows some of the major types and their uses.

In selecting a map we usually ask customers to visit the Map Library because describing a map over the phone can be difficult. One of the first questions we usually ask is what scale map is wanted. This is a confusing question because small can mean large and large can mean small. In other words, a small scale map covers a large area and a large-scale map covers a small area. Scales can run from 1:1,000,000,000 (one to one billion), which would be a map of the world the size of a postage stamp, to 1:1 (one to one), which you could get by putting a piece of paper on the floor, putting your foot on the paper and tracing around it. You would then have a map of your foot at a scale of one to one. Figure 1 shows three maps of  in small, medium, and large scales. The squares on the 1:1,000,000 and 1:250,000 maps represent the area covered by the 1:50,000 map.

FAMILY	NAME	USES
CYLINDRICAL	MERCATOR	Navigation and dead reckoning
CONIC	LAMBERT'S CONFORMAL	Atlases, pilotage and radio
AZIMUTHAL	EQUIDISTANT	Aeronautics, radio, engineering and celestial maps
	GNOMONIC	Trans-polar and trans-oceanic routes, radio and seismic work

FIGURE 2

EO 1.4.(c)
P.L. 86-36

Figures 3a through 3f show how the human head would be represented in various mapping methods, revealing their respective distortions.

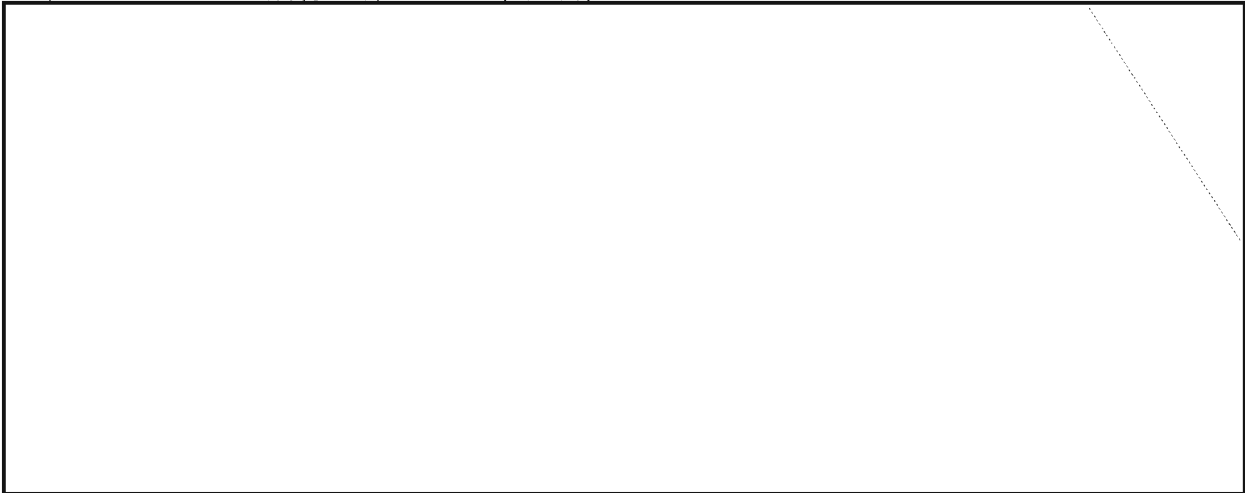

~~CONFIDENTIAL~~

~~CONFIDENTIAL~~



3a. Globular

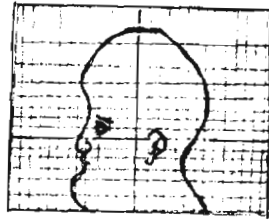

3b. Mercator

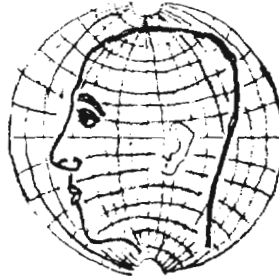

3c. Polyconic

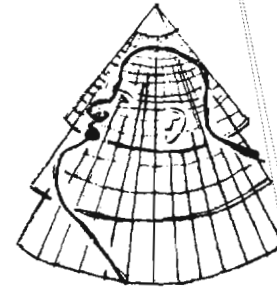

3d. Lambert's Conformal



3e. Stereographic

FIGURE 3



3f. Gnomonic

plotting, an outline map would be best. Terrain, briefing, and outline maps come in three general sizes: small, medium, and large depending on the size of the paper the map is on, not the scale of the map. In general small maps are letter size and are good for including in SIGINT and other types of reports. The map shown in figure 4 is a medium-size map

After the scale and projection questions have been solved, the major remaining problem is the type of features needed on the map. If you want a map to decorate your wall, a National Geographic Map with terrain features and many place names might be best. If you want to do

usually include a medium size terrain map with small special inset maps covering population, economics, vegetation, ethnic groups, and other relevant specialized subjects. The map library has these area brief maps for most of the countries in the world.

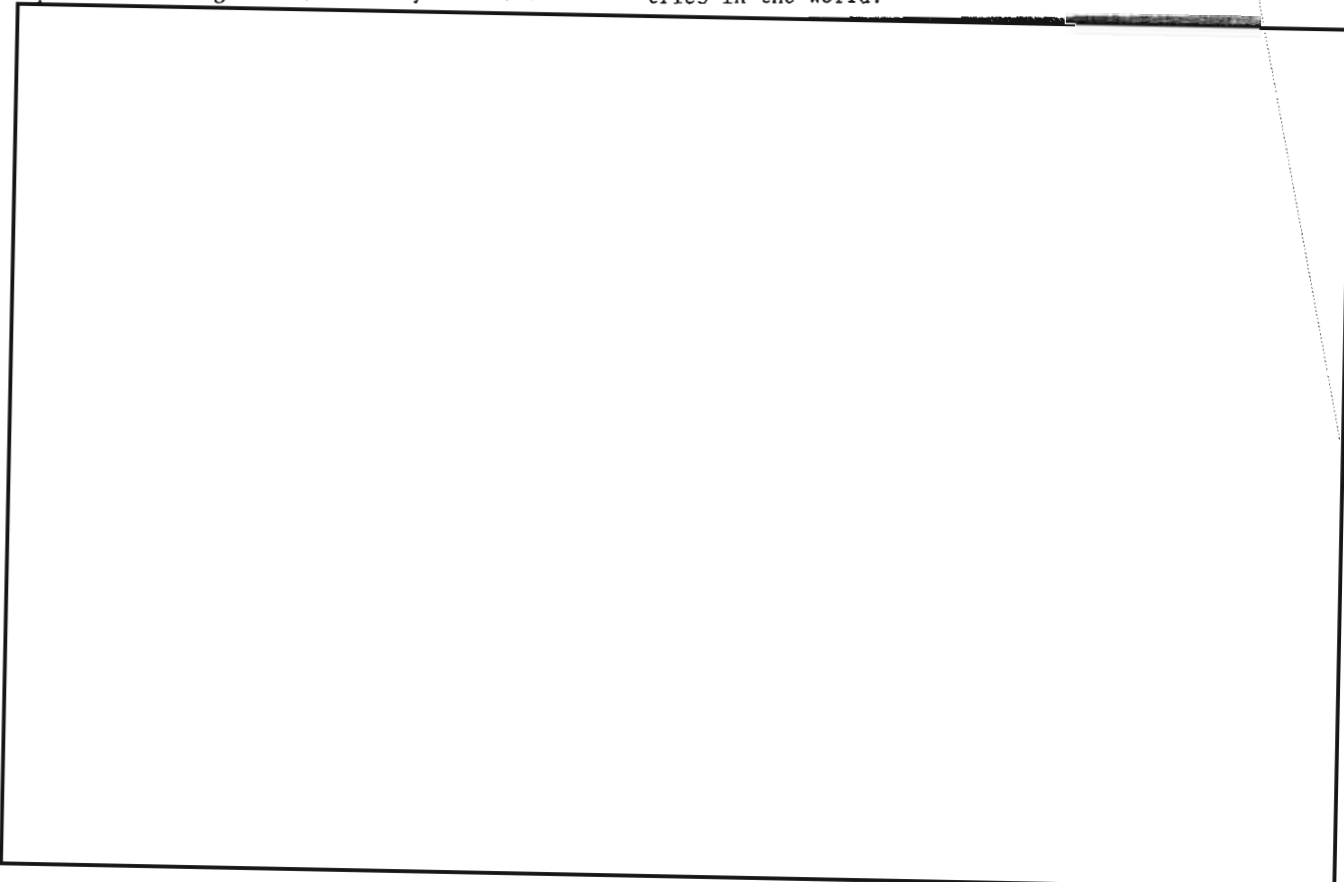

~~CONFIDENTIAL~~

~~CONFIDENTIAL~~

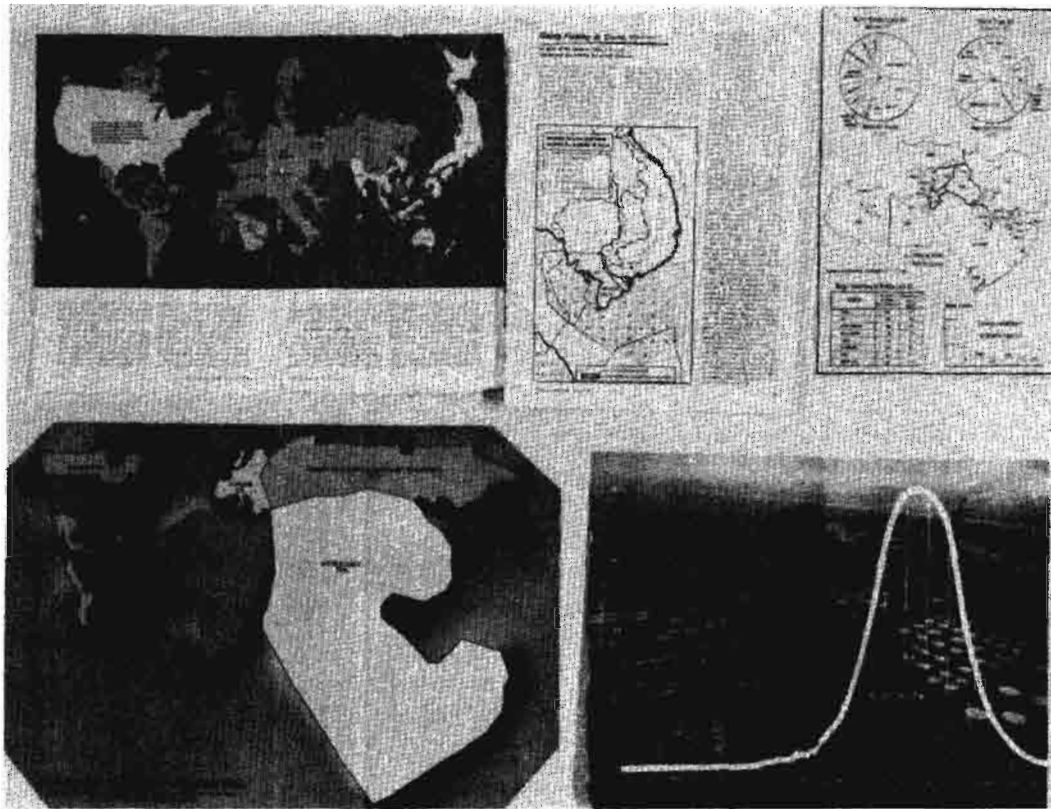

FIGURE 5

The last two figures cover special maps. In figure 5 you can see, if you squint real hard, a map taken from the National Geographic Magazine which illustrates the world wide use of oil. The United States is very large and Africa and Australia are tiny. The map below the oil use map shows in an exaggerated way the world of known oil reserves. These maps have been used as an ad for a well-known international oil company. These maps and the map from Forbes magazine, "Going Fishing in South Vietnam," which shows the oil concession zones in the South China Sea, illustrate the wide range of devices and distortions that maps employ to communicate and also the highly specialized nature of many maps. The Geography and Map Library has many examples of specialized maps: from maps which show oil pipelines, wells, pumping stations, etc., to bird hazard, whale, time zone, and ice charts to city and port plans to moon maps.

Figure 6 suggests the wave of the future as far as the production of many specialized maps is concerned. Computer plotting along with maps on microfiche and computer graphics will undoubtedly play a larger role for both geographers and Agency analysts. Of the examples shown in the photo, the one on the extreme right, illustrating field-of-sight plotting, would probably be the most useful for Agency problems.

Maps on microfiche can be useful when it is necessary to trace the course of a railroad, river, or border area over a long distance. Successive sheets in a map series can be photographically reduced and placed side by side on one fiche for easy visual continuity.

P.L. 86-36
EO 1.4.(c)

~~CONFIDENTIAL~~

~~CONFIDENTIAL~~

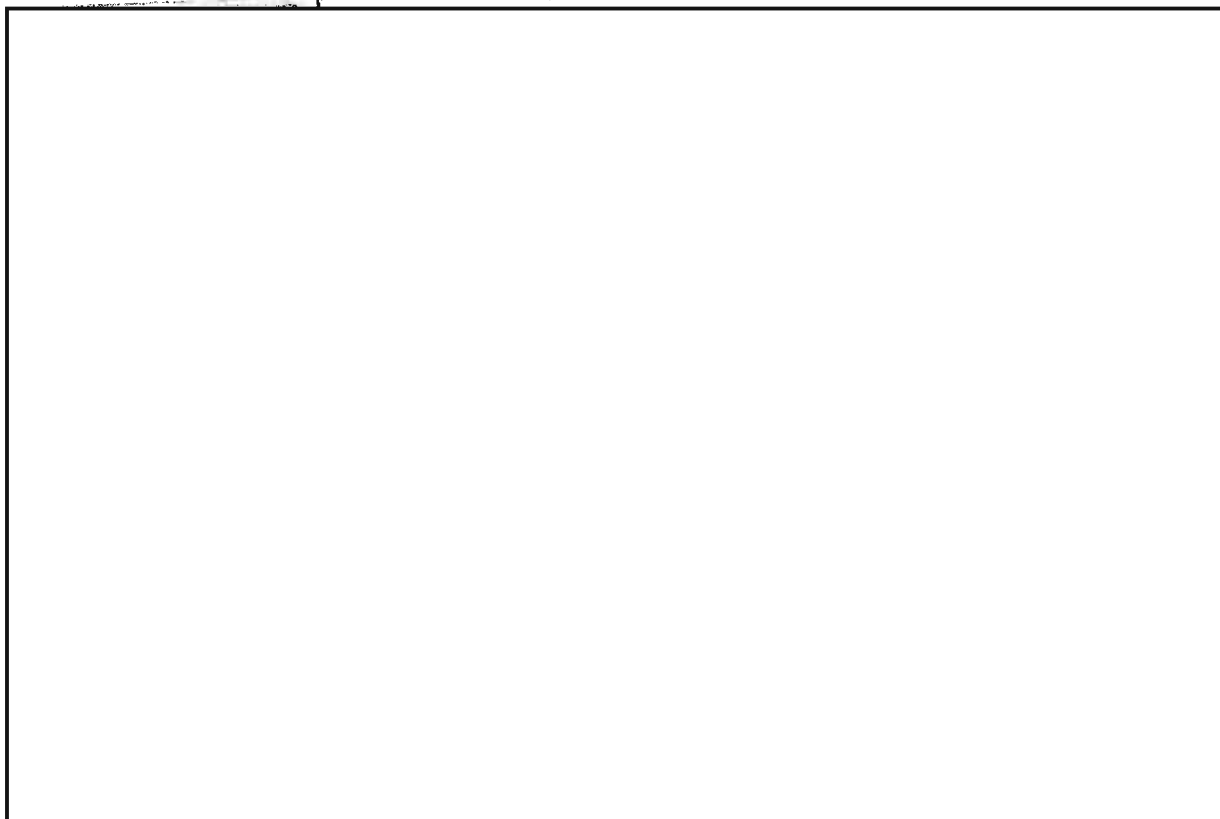

P.L. 86-36
EO 1.4.(c)

As far as computer graphics is concerned, the Agency already has map programs on the following computer systems; [redacted]

In conclusion, just remember to think out your map requirements in advance, then come on down and visit us in Room 2N075. Our hours are from 10 a.m. to noon and from 1:30 to 3:30 p.m. Also watch for our display at INFO 75 in March.

P.L. 86-36

SECRET

MESSAGES

Linguists, collectors, information technicians, SRA's, and data systems people can all find articles in this issue of CRYPTOLOG dealing with their specialty. Somehow or other, there isn't anything for cryptanalysts. . . or there wasn't anything for them until the Editor decided to fill this spot at the bottom of a page with three open-code messages from the back of Military Cryptanalytics, Part I. Each of these texts contains some other meaning besides the obvious one. Can you find the hidden message in each of these innocent-looking texts?

1. TO COVER AND HIDE YOUR FINANCES, I MAINTAIN STAFF TO BARTER FRANC EXCHANGE.
2. BEARER IS A FRIEND. I CANNOT WRITE MUCH. WILL YOU BE READY TO MEET A TRUSTED INTERMEDIARY SO YOU CAN GIVE ALL NECESSARY DOCUMENTS TO HIM NEXT WEEK? I HAVE NOTHING MORE TO SAY.
3. DISATISFIED WITH IMMEDIATE RESULTS OF YOUR ANALYSIS STOP ADDITIONAL RENUNERATION TO ALL PERSENNEL WHO INDENTIFY COMPONANT PARTS OF THE ALLOIS OTHER THAN NICKEL OR COPPER.

Sorry but we can't print the answers, since these problems are part of an extension course. . . but you cryppies shouldn't have much trouble with them.

(UNCLASSIFIED)

~~CONFIDENTIAL~~

~~TOP SECRET UMBRA~~

EO 1.4.(c)
P.L. 86-36

THE OLD



reminders
by

SECTION

Parts 3
& 4

Parts 1 & 2 appeared
in QRL, The Quarterly
Review for Linguists, Feb & May 7

P.L. 86-36

3: The Reviewer

The person who reviews the final English text

There are several advantages to having all outgoing messages read by one person:

- 1) The reviewer serves as a control point for conventions of style, usage, technical notations, spelling, publication series, priorities (sometimes a message looks hotter after degarbling, and priority is marked up) .
- 2) The reviewer can best control the quality of the translations and monitor the observance of standards. This is best done by a single person.
- 3) The reviewer, seeing all outgoing messages, is able to examine each one in the widest context possible. He can on occasion spot a duplicate translation which has slipped through the scanners unnoted.

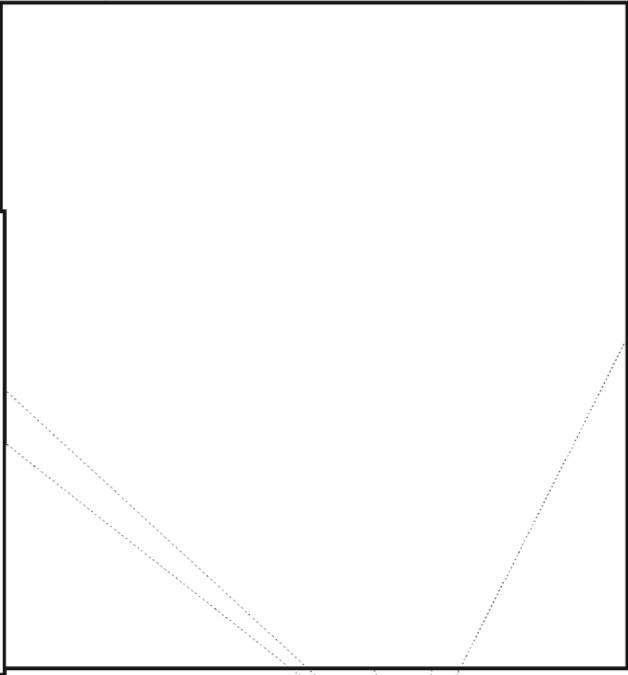
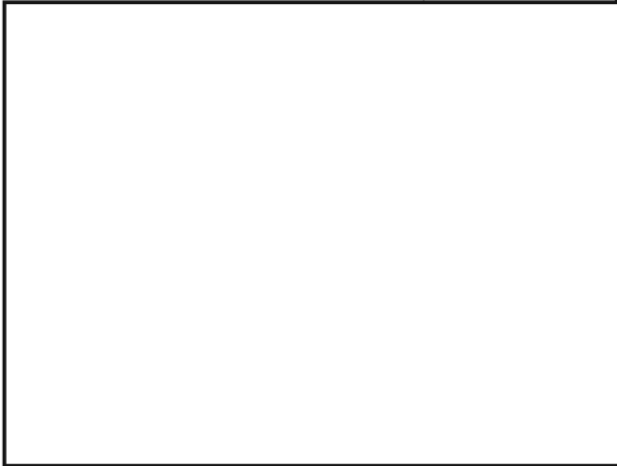

~~TOP SECRET UMBRA~~

EO 1.4.(c)
P.L. 86-36

~~TOP SECRET UMBRA~~

4. Section Chief

EO 1.4.(c)
P.L. 86-36

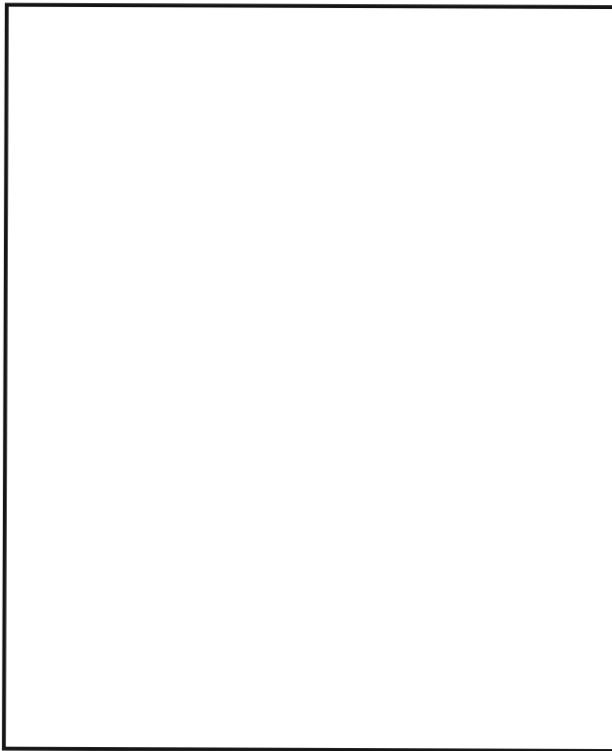

The determination of standards in general and in detail is the responsibility of the section chief. He must therefore be qualified as a linguist. There are two principal ways in which he is able to observe and thereby exercise control over the quality of the end product:

1) He may receive the requests for clarification of texts from the consumers and from editors within NSA and personally conduct the research required for these requests.

2) He may periodically check messages which have been translated and review messages which have been checked.

It is normally of interest to the section chief to read daily the top priority messages which have been disseminated by teletype and to examine them with the eye of a reviewer.



In 1963 President Kennedy expressed his solidarity with the beleaguered people of Berlin by proclaiming, "Ich bin ein Berliner!" This was understood without difficulty on both sides of the Atlantic. But what if he had wanted to express solidarity with the people of Hamburg-or still worse, Vienna? Americans might have been dismayed to hear the President call himself a Hamburger or a Wiener, for we are not always familiar with the forms that names of cities take to express citizenship.

Even in English these may be unpredictable. In the list below, can you give the correct or accepted English form for a resident of each city? (Answers on page 12.)

- | | |
|-----------------|--------------------|
| 1. Aberdeen | 13. Memphis |
| 2. Atlanta | 14. Moscow |
| 3. Cairo | 15. Naples |
| 4. Cambridge | 16. New Orleans |
| 5. Dallas | 17. Oxford |
| 6. Florence | 18. Parma |
| 7. Glasgow | 19. Peking |
| 8. Leghorn | 20. Rio de Janeiro |
| 9. Liverpool | 21. Shanghai |
| 10. Los Angeles | 22. Tangier |
| 11. Madras | 23. Trieste |
| 12. Madrid | 24. Warsaw |

(UNCLASSIFIED)

~~TOP SECRET UMBRA~~

~~SECRET SPOKE~~

An Approach to CALLSIGN ANALYSIS

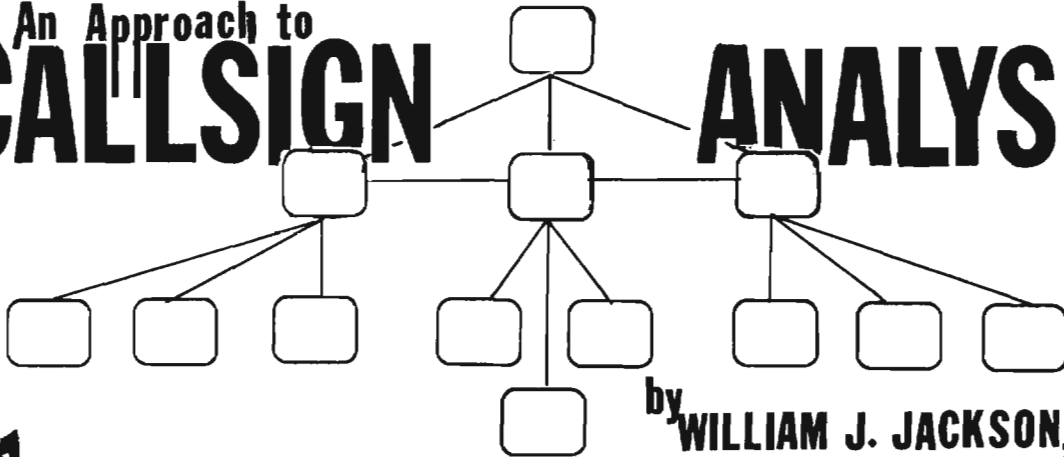

EO 1.4.(c)
P.L. 86-36

by **WILLIAM J. JACKSON, P14**

According to Mr. C. G. Garofalo, former chief of P14, who is the individual most responsible for the solution of a number of target callsign systems over the past 30 years, the first step you should take when faced with the job of solving a new and complex callsign system is to go on two weeks annual leave!

significant system characteristics and of phenomena useful in analysis. Several standard forms are available for this purpose.

Assuming that the system is not immediately obvious, the initial objective is to determine what type it is.

The better either you or the team does on continuity, the easier and more successful your callsign analysis is likely to be. In addition to the requirement of continuity for successful analysis, another is that of complete openmindedness in the approach to the problem: no idea, no suggestion, should be dismissed as being implausible. (Remember, Aristotle said that a likely impossibility is always preferable to an unconvincing possibility.)

Probably the best approach to callsign study, after a number of callsign continuities are available, is to arrange the callsigns in a form which will facilitate the recognition of

EO 1.4.(c)
P.L. 86-36

~~SECRET SPOKE~~

~~SECRET SPOKE~~

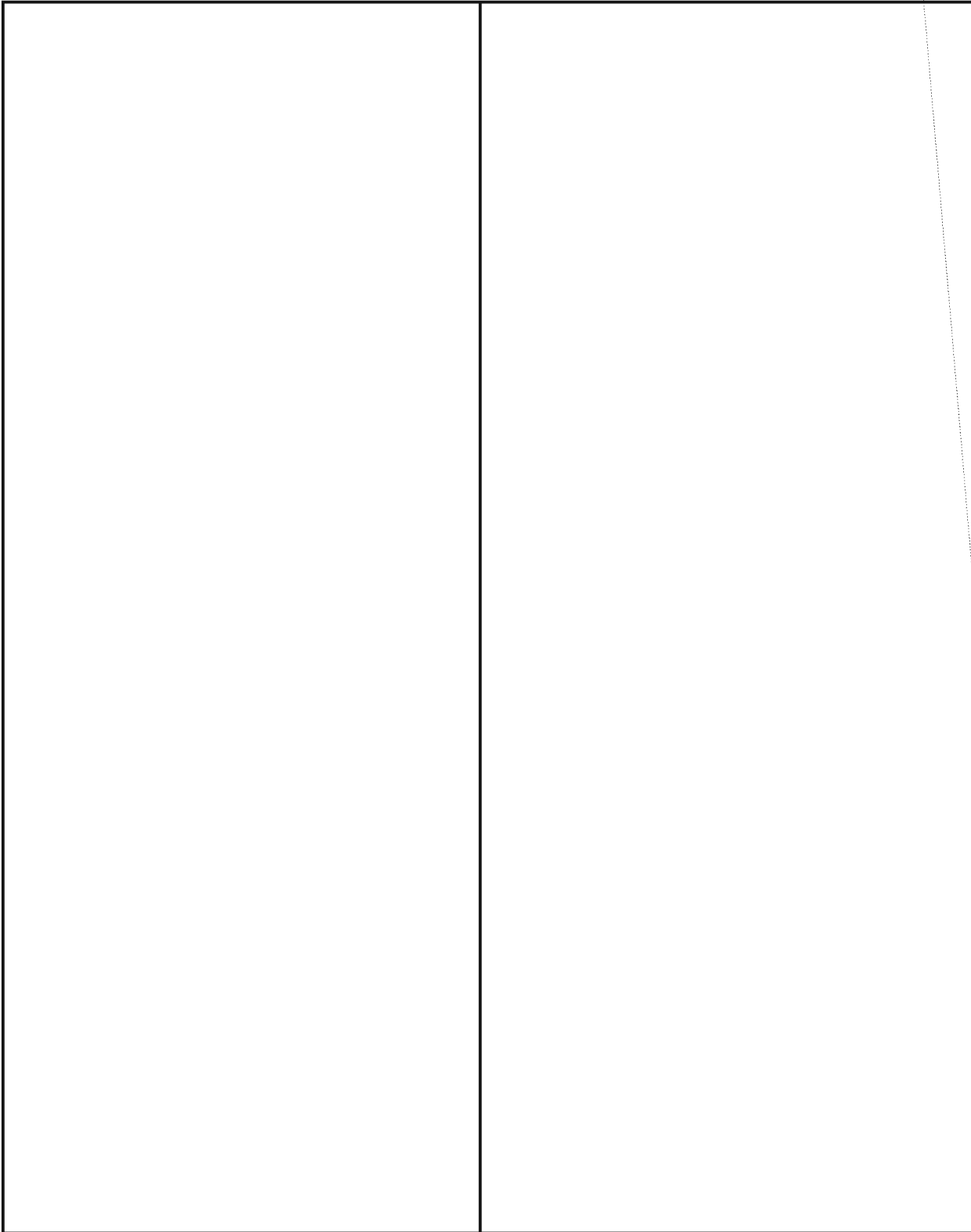

~~SECRET SPOKE~~

~~SECRET SPOKE~~

<p>In forthcoming issues of CRYPTOLOG it is expected that one or more examples of the application of the foregoing approach will be presented.</p>	

LETTER TO THE **E**DITOR

To the Editor, CRYPTOLOG Magazine:

The article in the September issue, "COMINT Analysis of [redacted]" by Derek Craig, is of great interest, but may I comment on this article?

Mr. Craig's analysis [redacted] was a valuable piece of reportage, and I personally enjoyed reading it and learned a lot from it.

Thank you for a very fine new magazine.

EO 1.4.(c)
P.L. 86-36
(Name withheld by request.)

~~SECRET SPOKE~~

~~CONFIDENTIAL~~



Forming New SPECIAL INTEREST GROUP on



Human Factors

by [redacted] A63

P.L. 86-36

D

id you ever wonder. . .

how many hours are wasted because analysts have to read output in "computerese" that borders on low-level encipherment?

how many ACRP operators have trouble copying traffic due to high noise level in the aircraft, or possibly have hearing problems from the noise?

how many errors are made because of poor keyboard design or non-standard layouts?

why your typing keyboard is so high that it gives you a backache or tired shoulders, or just feels uncomfortable?

why somebody designed your operating console so you have to stretch to reach the controls, or why they didn't give you enough writing space?

how many computer jobs have to be rerun because the tape label was hard to read and the wrong tape was mounted?

how long this list would get if you really thought about all the other problems we live with, day in and day out, because someone forgot to consider the human being in the working environment?

Some of your colleagues have wondered, and are doing something about it.

Under the sponsorship of the NSA Computer and Information Sciences Institute (CISI) they are forming a Special Interest Group which will be called SIG/Human Factors.

The Special Interest Group's goals are:

To increase awareness of the need to consider human factors in our work, so that as systems and procedures are acquired or developed, (1) people are considered in relation to the total environment--which means consideration of human physiological characteristics, behavioral reactions, bio-medical factors, training, motivation, personal comfort and safety, and (2) the highest and best use is made of both human and machine resources through assignment of appropriate roles to each.

To stimulate NSA/CSS-wide interest, understanding and involvement in the human aspects of our business.

To promote a more efficient interace among people, hardware, software and environment in systems design, development and use.

To encourage the acquisition and application of information, tools and techniques to satisfy the above.

Through lectures, seminars, working groups and publications, SIG/Human Factors plans to provide opportunities to learn more about the human element in procedures and bring people with common interests and problems together on a professional level.

Under the general guidance of [redacted]

[redacted] (A63, ext. 3847), who initiated actions to start the SIG, the nucleus of the group presently includes

[redacted]

Jack Gurin (P16, ext. 5236).

Until the Group is more formally organized, these people are key points of contact. If you are involved in human factors work or are a user with a strong interest in how systems and procedures design affects you or your subordinates, please get in touch. We need your support.

As of now, commit yourself to a Vigilance Task (that's a good human-factors buzz word)! The task is to keep a watchful eye on your daily mail for notices of SIG/Human Factors activities, which should be starting soon.

P.L. 86-36

NO PAGE 19-20 IN NOVEMBER ISSUE

You may have noticed that the Table of Contents for the November CRYPTOLOG listed "A Medal for Horatius" on page 19 and a Letter to the Editor on page 20. You may also have noticed that your copy didn't have pages 19 & 20 in it. It seems that the writer of the letter included some terminology and information that were better left unpublished in a general newspaper. Alas, the breach was not realized until the issue had been printed. . . .so in the interest of security the offending page was bodily removed. The letter (duly sanitized) will be found on page 9 of this issue and the Golden Oldie about Horatius' medal will be included in CRYPTOLOG sometime soon. (UNCLASSIFIED)

~~HANDLE VIA COMINT CHANNELS ONLY~~

~~CONFIDENTIAL~~

~~CONFIDENTIAL~~



by W32

P.L. 86-36

THE NEW COLLECTION CRITERIA

The Collection Career Panel has now in draft a new set of criteria for Professionalization. The new criteria are to be published, we hope, in January 1975. Some description of the new criteria will be found below, but for now, let us just say that they are more pertinent.

When the new criteria are published, aspirants who have already submitted Professional Qualifications Records (PQR's) will have a specified amount of time from the publication date to achieve certification under the existing criteria. The new criteria will contain some rigid requirements--some specific demands -- not found currently. At the present, it is not easy to be a professional Collector; in the future it will be more difficult. At the present, training requirements may be met by peripheral courses and on occasion credit must be given for courses of very little relevance to the Collection business. The criteria to be published will afford points for any training or education, as before, but will require some specific Collection-related training as well as requiring some additional training from a set of "elective" courses. The specifics of the training requirements have not been agreed on entirely, but the basic concept will prevail as will most of the training required in the draft.

From a purist's point of view, the new criteria are exemplary in concept. There will be two professional areas: Collection Specialist and Collection Officer.

The Collection Specialist will be concerned primarily with Collection operations and it is intended that certification in this specialty will enable the individual to be promoted in professional-level assignments through grade GG-13.

To be certified as a Collection Specialist, an aspirant must have amassed 1,000 points, must have met certain minimum standards (including having taken some specific training courses), and he must have passed a Professional Qualification Examination. While academic education is always an asset in any professionalization system, technical training and achievements are stressed for a Collection Specialist, with academic education a very desirable adjunct. The emphasis for the Specialist is on technical competence.

The Collection Officer will be, as he is now, more oriented toward staff and management. The criteria for him will include certain minimum academic education requirements and some different required training courses, and some of the other minimum point requirements may be higher. Many of the basic requirements will be the same for the Collection Officer as for the Collection Specialist, so that the points earned in achieving certification as a Specialist will go a long way toward certification as an Officer, but it may be possible to become a Collection Officer without being able to qualify as a Collection Specialist. The normal progression, however, will probably be for an aspirant to be professionalized as a Specialist first.

~~HANDLE VIA COMINT CHANNELS ONLY~~
~~CONFIDENTIAL~~

~~CONFIDENTIAL~~

Besides the addition of academic education requirements for the Collection Officer, he too will be required to pass the PQE. Further, he will also have to pass an oral examination board. When the aspirant has met all the minimum requirements, has passed an objective written qualifying examination, and has then been subjected to a further screening by an examining board, he will have demonstrated real professional competence. The new criteria will not be more difficult than those in existence now, probably, but they will be more rigid, more specific, more demanding. They will be focussed more sharply on Collection and in many ways will be more objective. This writer feels that they will be a vast improvement.

ed for the career field. With the advent of the new criteria, a definite plan can be drawn, a career can be mapped out in Collection from the beginning. A potential professional Collector can be groomed and be guided by the criteria through a career from the time he enters on duty. Those of us elderly personnel who have floundered and drifted through an entire career can appreciate how much that could mean.

And let it be said one more time: The Collector is the backbone of the SIGINT system. Without him there is nothing for the other disciplines to work on. We need competent, professional Collectors, and through the new criteria, we will develop them.

One of the chief benefits to be derived from the proposed criteria is that, for a very welcome change, a curriculum is being establish-

~~(CONFIDENTIAL - HWCCO)~~

CITIZENS OF THE WORLD Answers (see page 6.)



1. Aberdonian 2. Atlantean (Not Atlantean; that's a whole nother story) 3. Calrene (rhymes with "gyrene") 4. Cantabrigian (from Middle Latin) 5. Dallasite 6. Florentine (as in Eggs) 7. Glaswegian (hoo! mon; That's ver-r-ry irreglar; probably influenced by Galwegian & Norwegian. Did you have to think for a moment to figure out what Galwegian comes from?) 8. Livornian 9. Liverpudlian (the "pool" becomes a "puddle") 10. Angeleno or Angeleno (depending upon whether or not you know Spanish) 11. Madrasai 12. Madrillean ("Madrilleno" is the Spanish form) 13. Memphite (if the city is in Egypt) or Memphian (if it's in Tennessee) 14. Muscovite 15. Neapolitan 16. Orleanian 17. Oxonian 18. Parmesan (as in Cheese) 19. Pekingese 20. Carioa (No, this doesn't come from the name of the dance; the dance was named after a person from Rio, and the word is derived from the Tupi Indian words for "white house") 21. Shanghaiander (Honest; look it up yourself) 22. Tangerine (ditto) 23. Triestino 24. Varsovian

(UNCLASSIFIED)

The English Language in the News

by 
P16

P.L. 86-36

ENGLAND: Some messages sent in 1910 from a sea captain to Scotland Yard



---marking the first time that radio was used to capture a criminal---were auctioned off in London recently for about \$4,000. Those messages led to the arrest of Dr. Hawley Crippen who left the dismembered body of his wife in the basement of their London home while he and his girlfriend went for a cruise to Canada aboard the liner Montrose. The captain became suspicious and used his ship-to-shore radio to ask Scotland Yard for advice.

A British boxing fan who was hoping for a son has given his new daughter a name involving the surnames of 25 heavyweight boxing champions and for the rest of her life the girl will have to fill out forms with: Maria Sullivan Corbett Fitzsimmons Jeffries Hart Burns Johnson Willard Dempsey Tunney Schmeling Sharkey Carnera Baer Braddock Louis Charles Walcott Marciano Patterson Johansson Liston Clay Frazier Foreman Brown. How did "Maria" get in there?



British males made sterile by vasectomy operations have begun wearing neckties with a special "V" motif, originally designed to promote the operation, but according to an official of the Vasectomy Advancement Society, many men who have not had the operation are placing orders for the ties.

Dec 74 * CRYPTOLOG * Page 12

~~HANDLE VIA COMINT CHANNELS ONLY~~

~~CONFIDENTIAL~~

~~CONFIDENTIAL~~



FLAG WAVING PROGRAMMER

by GEORGE JOHN, G42



Until six months ago I considered myself a competent programmer, but since writing a recent series of data handling programs I've had to revise that opinion. The programs behaved well when being written and initially debugged, but got rowdy after being given to an analyst for routine use.



The job I tackled was to write a family of programs, one for each key system, to sort the key by identification, eliminate duplicate records, and add the newest data to a blocked tape. This tape would then contain all known key on that system, in a prescribed order.

The analyst who was to use the first program gave me the following information about the input data:



Taking the given information with a simple (minded) faith I proceeded to write programs to do the job.

The first time the analyst brought back one of the programs it took me a week to discover that the failure was caused by missing separators between the lane groups in the input tape. I had not thought to look there.

The second time she brought it back I analyzed the program logic for another week before I noticed that the segment numbers on the input tape were not in the proper order. I added a sort step to the program.

One of the other programs failed and after two weeks of looking at the program I found out that the analyst had combined two tapes onto one and input that one to my program. This introduced duplicate records and separate blocks of the same key, and thoroughly confused the program and me.

It only takes one wrong record to derail a program, and unless that record is flagged at the time, you may find yourself searching through thousands of records without knowing what to look for. When an analyst tells you "All of the data has these characteristics" try to remember the wise old saying: "Statements that use 'always' or 'never' are always false."

Programmers can gain more yardage by having the computer act as referee. At each point where "unnecessary roughness," "offsides," etc., can occur, include the following:

- a. A statement of what is wrong with the record;
- b. A printout of the records that were being processed when the flag was thrown; and
- c. A branch to read a new record and continue processing.

This technique should help both in initial debugging and in planning later revisions.

I'll just run it up the flagpole and see who salutes it.



P.L. 86-36

P.L. 86-36
EO 1.4.(c)

WANT AD

WANTED: Unwanted RYE GUPPY Manuals. If you have a Manual in good condition and no longer need it please send it to [redacted] E13, FANX 2, for use in Cryptanalysis training courses.

~~HANDLE VIA COMINT CHANNELS ONLY~~
~~CONFIDENTIAL~~

A LONG HARD LOOK AT THE

Intern Program



PART FOUR: WHAT HAPPENS TO THE GRADUATES?

P.L. 86-36

[redacted] people have graduated from the intern program to date. What impact have they had on the work force? Is their performance notably different from that of college hires who took and remained in direct assignments? How do graduates feel about an Agency career? How do they feel about the intern program? While I have heard much concern about what would happen to college hires if they were required to have operational experience before being considered for an intern program, there seems to be relatively little concern about what happens to the graduates, and little effort directed at looking at the program through their eyes.

One panel did conduct a survey of graduates several years ago and found that approximately 20% of the graduates were having problems with their assignments and that the primary problem was lack of challenging work. There are two ways to look at the results of that survey--one is to say that the hands of those graduates were held for three years and if they encounter problems now they should be resourceful enough to know how to handle them. The opposite approach is to say that after spending thousands of dollars on classroom and on-the-job training for these people, it is foolish not to have some type of follow-up program to ensure that they are being usefully employed and to monitor their careers in order to keep abreast of problems that seem to be common to a number of them.

In fact, there do seem to be some patterns in the careers of that panel's graduates that would concern me if I were a Panel member or an M3 employee. The survey cited above revealed that sex and group assignment seemed to have a very significant bearing on career advancement. For instance, at the time of the study 14% of the graduates either had been assigned to Group X by the Panel or had transferred there and 17% of the graduates had been assigned to Group Y or had transferred there, but 57% of the promotions received by that Panel's graduates went to those in Group X and not one of the Group Y graduates had been promoted. If I were a Panel member, I would want to know if Group Y really had appropriate jobs for their graduates. Promotional opportunities also seem to have a sexual bias: 46 women and 43 men had graduated from the program as GG-11's. At the time of the

study, six graduates had been promoted to GG-12; they were all men. Sixteen months later the grades of the first five classes this panel graduated were reviewed. By that time 17 of the graduates were 12's; 14 of them were men. While the Agency reorganization made it difficult to continue an organizational analysis, it was possible to determine that Group Y had yet to promote a graduate.

These findings suggest that the most significant indicator of a graduate's future advancement in this career field may be his sex, and that Group assignment is also a significant predictor; however, on a theoretical level Career Qualification Battery scores are used to predict success in a career field. How did the CQB scores of the graduates who were promoted compare to those not promoted? Scores of 57 graduates who remained in that career field from the first five classes the panel graduated were analyzed. For the 20 graduates who had been promoted to either GG-12 or GG-11 as of December 1973, the average CQB score in the category that pertained to their career field was 5.25. The average score of the 37 graduates not promoted was 5.64. I said previously that if I had faith in CQB scores as predictors of success and viewed the program as a highly selective one, I would require a higher score than the 5 that most panels currently require of program applicants since a 5 indicates average test performance. Actually, what the Panels may be expressing by not requiring a higher score is that they do not have such faith in CQB scores. In the case of this panel the requirement for a 5 was not even enforced for 15 of the 57 graduates; if it had been adhered to, almost half (9 of the 20) graduates who have been promoted would not have been accepted into the program. Three of those nine did not even receive a score of 4 and thus needed a waiver since they did not receive a qualifying score for the COSC. On the other hand, only 6 of the 37 not promoted (16%) did not receive a score of 5 or above and only one of those 6 did not receive a qualifying score for the COSC. While these are admittedly very small samples, these figures make me uneasy when I consider how much emphasis is placed on CQB scores in determining which employment applicants will be hired, and then what fields they will enter.

That uneasiness prompted me to do some further research into CQB scores. I next compared scores of 60 interns, 30 with a degree and 30 without a degree for the category that pertained to their career field. In view of the recent proposal that the program again be limited to college graduates, I was impressed by the fact that the average score for non-college graduates (6.46) was higher than that of the college graduates (5.87). That difference in average scores may suggest that performance on the CQB could be affected by experience even though, with an aptitude test, this should not be the case. This theory received additional support from the test records of 8 on-board interns who took the CQB twice. Their two attempts yielded a total of 206 scores so 103 comparisons of scores could be made. Scores improved by 1 to 5 points in 56 cases, stayed the same in 26, and dropped in 21. Given a universal requirement of 5 for consideration for an intern program, these people would have gained eligibility in 20 categories and lost eligibility in 8. The most dramatic change was an applicant who went from a 3 to an 8, going from a score that was too low to even be considered for the program to a score that made

him a prime candidate. The possibility that the first day was just a bad testing day for this individual is diminished by the fact that scores for 4 of the categories remained constant.

Another thing about the CQB that disturbs me is that the CQB battery seems to have changed little, if any, in the nine years since I first encountered it, although some career fields have changed considerably during that time.

the SR field has attempted to assert its identity as a definable career field rather than a catchall for people who do not seem to fit into any other field. Does the present CQB, and the weights given the various subtests, adequately reflect this, or is the battery a selection tool that was appropriate for the fields ten years ago but not today?

My discussion so far applies to just one panel. The study that was done by the specially designated Intern Study Task Force provides a

EXTRACT FROM TABLES

Graduate interns 1969 and 1970

	CA	DATA SYSTEMS	LANG.	TA	SR
Number of interns					
Grade: GG-9					
GG-11					
GG-12					
GG-13					
Not Promoted Since Graduation					
Last P/A Outstanding					
Overseas Tour					
Resignations					

P.L. 86-36

FOOTNOTES

The categories of "Number of interns" and "resignations" were not defined but it appeared that "number of interns" referred to graduates who were still at the Agency and did not include graduates who have resigned since the sum of the figures in the grade breakdowns equaled that given for "number of interns." (The one exception to this was the SR Panel for which "Number of interns" appeared to equal the figures from the grade breakdown plus resignations). Therefore, to determine the total number of graduates I added "number of interns" to "resignations." This total was used only for the attrition information.

EO 1.4.(c)
P.L. 86-36

broader look into the fate of the intern program graduates. When I first looked at one of the study's charts, part of which is given above, I didn't see much of interest. However, I then used the data provided as the basis for additional computation and some interesting patterns began to emerge.

The information provided above yielded the following statistical information:

A. Percentage of Graduates Promoted by Career

<u>Field</u>	
DS-	(57.5%)
TA-	(33.3%)
LG-	(33.3%)
CA-	(23.6%)
SR-	(17.2%) (These graduates were at a disadvantage since the first SR interns did not graduate until 1970 while other panels graduated interns in 1969.)

B. Percentage Promoted by Career Field and Sex

DS-M (66%)	SR-M (22.5%)
LG-M (58.3%)	CA-F (12.9%)
TA-M (50%)	SR-F (11.1%)
DS-F (39.1%)	LG-F (8.3%)
CA-M (37.5%)	TA-F (0%)

C. Percentage Receiving Outstanding Performance Appraisals by Panel

TA (86.6%)
LG (50%)
DS (47.9%)
SR (46.5%)
CA (27.2%)

D. Percentage of Outstandings by Sex and Career Field

TA-M (90%)	DS-F (43.4%)
TA-F (80%)	LG-F (41.6%)
LG-M (58.3%)	SR-F (37%)
SR-M (54.8%)	CA-F (29%)
DS-M (50%)	CA-M (25%)

E. Percentage of Graduate Resignations by Panel

TA (44.4%)
LG (33.3%)
CA (15.4%)
SR (13.4%)
DS (1.4%)

F. Percentage of Graduate Resignations by Sex and Career Field

TA-F (54.5%)	LG-M (20%)
LG-F (42.8%)	SR-M (6.1%)
TA-M (37.5%)	CA-M (4%)
CA-F (22.5%)	DS-M (2%)
SR-F (20.5%)	DS-F (0%)

(To give additional perspective to these figures, the statistics on resignations of interns in the program, from its inception through the first quarter of FY75, were analyzed using an M3 report. The figures for these five panels were clustered between a low of 24.8% for CA interns and a high of 29.3% for Language interns.

It should be noted that these figures are lower than those contained in an FY74 Management Report. The difference may be due to varying definitions of attrition which will be discussed later.)

If I were an Agency manager and saw these charts I would want to know:

1. How do the figures for intern attrition in these fields compare with those for non-intern attrition? How do they compare with the figures for college hires who took direct assignments?
2. How many of these interns had prior cryptologic experience? I would be especially interested in this figure for the TA field. If those with prior experience do have better attrition records than the liberal arts graduates, as I suspect, why don't we concentrate on hiring them for fields like TA?
3. Has a study been done of the interns who resigned? Do college hires with certain majors and personality profiles tend to leave as I suggested previously?
4. We have heard much about the loss of data systems personnel once they have received some Agency training; however, the '69-70 data systems graduates had the lowest attrition rate at the time of this study, and at that time these graduates had been with the Agency for up to eight years. Is their graduate attrition rate the direct result of having the highest promotion rates? Is there a leveling off that takes place--do those who stay here five years tend to make their careers here? Or has the attrition rate for data systems graduates changed for the worse in recent years? One C Group manager told me of his idea to try to establish a model based on the past attrition of data systems personnel and changes in the nation's economy. Such a model could possibly alert Agency managers to an impending large-scale loss of data systems personnel. Did such a model ever become a reality?
5. Is there a logical explanation for the fact that the resignation rates for interns while in the program are closely clustered, as among the various fields (24.8--29.3%), but resignations of graduates show wide variation (1.4--44.4%)?
6. Why is there little relationship between the panel rank order for promotions and the one for outstandings? Is it much harder to get an outstanding if you are a cryptanalyst than if you are a traffic analyst? Why do female TA graduates have the second best percentage for receiving outstanding performance appraisals but not one of them had been promoted? Why is it that the performance appraisal percentage for the female CA graduates is better than that for the males but the reverse is true for their promotion percentages? Is it true that women are given outstandings while men are given promotions?

7. Why is it that only 2 of the 19 field assignments received by intern graduates have gone to women? I suspect that some people would reply "Because women aren't interested." Then isn't it interesting that 2 of the 5 TA women graduates have field assignments? What was so different about those women compared with the other female graduates?

8. I strongly suspect that if the study had shown promotions received by organization there would have been biases across the board just as there were in the study that the one panel conducted. Are such biases of interest to M, the Panels, or Agency managers?

9. Is it of interest to M3, the EEO office, or Agency managers that the promotion figures show the most sexual segregation and that the male graduate who statistically has the worst chances for promotion still has a better chance than every woman graduate except those in the data systems field?

I think it is unfortunate that studies such as this one usually stop short of looking for cause and effect relationships and thus are not as meaningful as they should be. In this study I think some of the questions asked were too vague to allow the task force to do this type of analysis. For instance, if I were one of the supervisors who was asked "Is there a difference in the work performance of an on-board intern graduate compared with a college campus intern graduate?" I would ask that the categories be broken down further. Maybe I would take a college hire with military experience as my first choice, an on-board college graduate as my second choice, an on-board intern with no degree but related military experience as my third choice, a direct college hire as my fourth choice, etc.

I was also concerned by the type of question that intern graduates were asked. Perhaps the originators of the study did use some graduates as a sample before administering the questionnaire but such a review was not evident in the final questions. Most of the ten questions were of an opinion nature e.g. "Is there a continuing need for an Intern Program in your career field?" While the answers to such questions are certainly of interest, as an intern graduate I felt there should be managers better qualified to supply an informed answer than I. To me, the value of asking intern graduates to compare their performance with that of non-interns is also dubious and I question the wisdom of using such subjective questions as part of a study that was designed to determine if the intern program should be continued.

If subjective questions are used they should be followed up by facts and figures. In this case, would facts and figures support the

subjective opinion included in the study? In comparing job performance, the majority of graduates felt that their job performance was more effective than that of their non-intern peers. Since I wasn't able to compare effectiveness of job performance, I compared the grade levels of intern graduates, current on-board interns, and college recruits who took and remained in direct assignments for one career field. In doing this I reasoned that there should be a relationship between job effectiveness and grade level even though previous research indicated an organizational and sexual bias associated with promotions.

I established the following parameters for determining who would be in my sample to insure that the people I was comparing would, in fact, be similar: only employees who had a degree, were born in or after 1942, did not have more than 12 months difference in their Agency and government service computation dates, who still held a COSC for that career field, had not been an intern in another career field, and were not assigned to a group that contained only intern graduates or only direct hires. Since the intern program is described as a highly selective program, I envisioned that I would be able to find several employees who had been given direct assignments for every intern graduate; therefore, I was surprised when I found 31 intern graduates and 15 current interns but only 29 direct hires who fit these parameters. The selectivity ascribed to the program and the fact that the original interns had received two virtually automatic promotions also made me suspect that the intern graduates would have a grade edge, but an analysis of the grades of these three groups revealed a very mixed picture. In general, the employee with the highest grade of a group that started in a particular month could be either an intern graduate or a direct hire; the honor never went to a current intern (it should be noted though that interns can not be promoted above GG-11). I noticed that when I reached employees who have been at the Agency for 66 months or less that the Agency-wide shortage of promotion funds tended to produce an equalizing effect but, interestingly, four of the five people who have been promoted from that group were direct hires; the fifth was an intern graduate. The lesson for on-board employees considering entering the program apparently is that if promotion is a major concern, they will probably do just as well, if not better, staying in an operational assignment--particularly if money remains tight.

Until now I have not made any reference to the attrition rate for women as compared with that of men. I still hear supervisors voice reluctance first to hiring and then to giving ad-

vanced training and promotions to young women, giving as their reasons that the women are likely to marry and then leave the area or become pregnant and resign. It is no longer valid to use such arguments. I also suspect that in many cases a baby may not actually be the prime cause of resignation, but its arrival represents a socially acceptable reason to leave a job with which the individual may have been disenchanted for some time. In fact, I wonder how many men would elect to stay in their current jobs if at some time between the ages of 25 and 35, they were placed in a position where the social pressure they received was to resign rather than stay on the job and when they were in a position where they knew statistically that their chances for success were considerably lower than those of their counterparts of the opposite sex.

Motherhood doesn't necessarily make a woman less interested in an Agency career provided she believes that she has a chance of advancing in that career. It is disturbing to me that the female intern graduates may be suffering from the same types of handicaps as far as advancement is concerned that women in previous eras did. I had hopes that since the intern program gave men and women the same training, work experience, and promotional opportunities, that this equality would carry over into their post graduate years.



Conclusion:

Much of what I have said really concerns one central issue: Is there a well defined philosophy behind the intern program as well as other Agency programs and practices? By "well defined," I do not mean fixed; in fact I do not believe that anything should be considered exempt from change, but just as the data systems analyst documents a program he writes, there is a need to document personnel practices. Because of frequent changes in administration and a lack of such documentation, there is a tendency for Agency personnel to continually "reinvent the wheel." In the case of my article, I realize that few of the ideas are unique; even so, I was somewhat surprised when, while working on this month's installment, I came across an Agency Management Report that included these questions:

Are college graduates needed for all the jobs that these individuals are now on? Are some college graduates being put on the wrong jobs? Is the Agency hiring more college graduates than it needs? Is there such a thing as an ideal NSA type that perhaps should be recruited?

These questions sounded much like some that appeared in my first installment, but they were contained in an October 1961 report.

Were these questions answered in 1961? If they were, and the answers were documented, and readily available maybe I would not have repeated the questions in 1974. Or perhaps on the basis of the documentation provided, I could have seen that those answers seemed appropriate for the Agency in 1961 but not in 1974.

Footnote on program statistics: In my research I encountered several problems of definition which M3 and the Panels must also have encountered. For instance, how do you define terms such as "graduate of the program" and "attrition"? In the past some panels classified anyone who completed the program as a graduate whether he achieved certification or not, while other panels apparently considered those who completed the program but were not certified as "transfers out." I indicated previously that the figures on intern resignations in one M3 report differed from the figures on intern attrition in another report based on M3 input. The explanation may be that "attrition" includes more than resignations in one case but this was not evident. I can think of several types of attrition figures that would probably be of interest in reviewing the program:

A. Program attrition: How many people who enter the program complete it? This would include transfers out and resignations but only those people who resign during their internship. This could be further broken down in several

ways such as direct hires vs. on-board interns, college graduates vs. non-graduates, etc. B. Current intern resignations: what percentage of interns leave the Agency during their internship? C. Graduate attrition: What percentage of graduates are left to mark five or ten years at the Agency? (This assumes there is a method of identifying intern graduates; in the past there has been no systematic way of doing this) D. College hire attrition: This could also be broken down into sub-categories such as college hires who go directly into the intern program, who take and remain in direct assignments, and who become on-board interns. E. Career Field Attrition: The purpose of the program is to supply professional level employees for a specific career field. How many graduate interns leave the field within a year after graduation, five years after?

Which of these categories, if any, do the attrition figures compiled by M3 fall into? Without precise definitions for terms such as "graduate" and "attrition," statistics on the program using such terms are of questionable value.

It is natural for a new manager to want to leave his mark on a position, but in his attempts to do so it is possible that he may institute a program very similar to one that failed five years before. All too often the employees concerned and the administrator's successors do not know whether a change was made for philosophical reasons, budgetary reasons, for the sake of change itself, or simply as a display of power. The changes I am referring to affect virtually every aspect of Agency employment, including hiring, training, course content, criteria for professionalization, reorganizations, and relocations.

Such documentation would be extremely valuable in program evaluation. It appears that there are often two sets of goals for a program, those that are written and those that are understood. There is nothing in the 1973 Intern Program Study to indicate that one of the primary motivations for establishing the intern program was to reduce the attrition rate of college hires, but if you ask an M3 employee to evaluate the effectiveness of the program, reduction in attrition is likely to surface as a major motivation for starting the program and as a significant accomplishment of it. (Attrition has dropped from the 65% reported for college hires in a 1961 management report to the 30% reported for interns in an FY74 management report.) If this was a primary goal, maybe continuation of the program would be justified on the basis of that reduction even if none of the graduates were certified; but then attrition statistics should be a factor in program evaluation, and every effort should be made to determine how much of the reduction in attrition can be credited to the program and how much to other factors, such as a change in the economic climate of the country.

It also seems appropriate to ask: Would there have been other equally effective ways to reduce attrition? Is there a point at which the reduced attrition no longer justifies the cost involved? Is there a point at which it becomes counterproductive? I suspect that the Agency attrition rate would be even lower if all new hires were started as a GG-9 and guaranteed a GG-11 30 months later, but it would be lower for the reasons alluded to previously: the recruits, good or bad, would soon reach a point where they felt they could not afford to resign.

A look at the orientation of new college hires illustrates another need for documentation. Currently there is a 9½-week orientation course for new uncleared hires, but cleared hires are available for assignment immediately -- usually on their third day in the Agency. My questions concerning this course are: is its primary purpose to give new hires an orientation to the Agency or simply to keep them occupied while processing their clearances? If the goal

is to give them an orientation, and if it has been determined that 9½ weeks is the amount of time needed for that, then every new hire, cleared or uncleared, should have the course. If the number of new hires dwindles to a precious few (as it did several years ago) other provisions should be made for the orientation, but the reason for discontinuing the formal course should be documented so that 10 years hence officials at the School, in M, and elsewhere will know whether the course was dropped because it was considered unnecessary or ineffective or because of cuts to the E budget. On the other hand, if the primary purpose of the course is to keep the new hires occupied and 9½ weeks is not really needed to orient them to the Agency, then it is reasonable to expect that cleared hires would be placed in a more concise course. If the number of people not cleared soon after completing that course grew to be a substantial one, it would also be reasonable to reinstate LIC working areas rather than continuing with the self-study courses that comprise the second portion of the present CY006 course. I suspect that the School already has machine records on courses, so perhaps the documentation I advocate could be done by simply inserting in existing programs a few comments about why courses were instituted, modified, or dropped.

Similarly the contents of the panels' annual reports could be adapted to provide for some philosophical consistency both within and between panels. This could save the panels from having to learn the same lessons independently. For example, in its original criteria Panel A stipulated that an aspirant could not take the PQE more than three times. When an aspirant vouched for by his supervisor as a very valuable employee, failed the test for the third time the Panel was in a quandary; the authors of the criteria had not included any ideas on what was to become of such people. The Panel concluded that it was not practical to limit the number of times an aspirant can take a PQE. About a year later Panel B published revised criteria in which one of the new features was a three-time limit on taking the PQE. Now it has apparently learned the same lesson as Panel A and recently removed the limit. Why wasn't the first panel's experience sufficient to keep the second from having to go through the same educational process? While the panels' annual reports are a means of sharing findings, and panel A's change in criteria probably was included in its report, in order to be of value to other panels and to successor members of the same ones, the announcement of changes in criteria should include the rationale behind it.

Once steps have been taken to explain the philosophy behind the intern program and other programs, the next step is to encourage discussion of them. I am not advocating "management by the masses," but I believe that keeping

employees informed is beneficial to all concerned and that every employee should be encouraged to comment on program features, to suggest improvements, or simply raise questions. I am not talking about a hot line to handle complaints, but a "philosopher's corner" in Cryptolog or Spectrum, where you might find an article composed of the views of an operational employee, an M3 employee, an intern graduate, and a current intern on what the goals of the intern program are and whether they are being met. Or an argument for specialization by an employee who has only strayed from his 20 year association with one problem for the six months needed for certification, side by side with an argument for diversification by someone who has

been with the Agency for 20 years and never spent more than two years in one place. Such a column might alleviate the feeling that many people have that the system has become more important than the people it was supposedly designed for.

I'll conclude my contribution to such a philosophical discussion by saying that it was not my primary goal to win converts to all my beliefs, but I did hope to start people thinking about many facets of the program and asking which ones are good, which should be modified, and which eliminated. I hope that current and graduate interns as well as non-interns will now take up the discussion.

A Proposal for Calendar Reform

by
Francis T. Leahy, #15

When Julius Caesar introduced his calendar, he designated every fourth year as a leap year, the extra day being February 29th, as at present. However by the 16th century it became evident that there had been a few too many leap years, since their purpose, of course, had been to synchronize the calendar year and the earth's annual revolution around the sun. It seemed that there had been about three leap years too many for every period of 400 years. Thus at that time there had accumulated about 12 extra calendar days.

In 1582 Pope Gregory XIII proposed that the accumulated extra days be dropped all at once and that thenceforth all calendar years ending in 00 (except those divisible by 400) consist of 365 days and therefore not be leap years. (Following this rule, 1900 was not a leap year.) Summarizing: every period of 400 years would have only 97 leap years instead of the 100 that Julius Caesar had envisioned. Since $97 \times 366 + 303 \times 365$ is an exact multiple of 7, each of these periods of 400 years begins with the same day of the week.

There was general chaos, confusion and turmoil for several centuries, as each country found it expedient or necessary to come into line with the new Gregorian calendar. The United States, for example, did not adopt it until the time of the American Revolution, and then only after a long struggle. As great an improvement as the Gregorian calendar is over the Julian calendar, there will nonetheless be an accumulated error of one day after 3,200 years. I believe the turmoil that might occur at such a time can be avoided.

If Pope Gregory had had a large computer in his basement, he would have noted that by merely excepting every year exactly divisible by 128 from the Julian leap year rule, he could have had at once a simpler and a far more accurate calendar. Instead of 97 leap years every 400-year period he would have proposed 31 for every 128-year period. Oddly enough, this leaves 97 normal years. (The number 128 is two to the seventh power, or 10 000 000 in binary notation. This may or may not be of mystical significance.)

If we now decide to adopt this improved rule, it would first affect the year 2048, which at the moment is scheduled to be a leap year, although of course it should certainly not be one.

If the earth continues to rotate at its present rate, the proposed calendar will be accurate for 173,000 years. (Actually it slows down by one second per day after 500 centuries.)

(Note: The true period of the earth's revolution now is 365 days, 5 hours, 48 minutes, 45 seconds, and some hundredths of a second. We note that 5 hours, 48 minutes, 45 seconds divided by 24 hours results in 31/128. Hence one leap year dropped from the original Julian calendar of 32 such, every 128 years, produces almost perfect synchronization.)

~~CONFIDENTIAL~~

CRYPTOLOG INDEX FOR 1974

A Flag-Waving Programmer..... Dec 13
 A Letter of Introduction.....Aug 1
 A Long Hard Look at the Intern Program:
 Part 1: Program Philosophy & Recruitment.....Sep 16
 Part 2: Selection & Orientation.....Oct 11
 Part 3: Motivation & Morale.....Nov 15
 Part 4: What Happens to the Graduates?.....Dec 14
 A Proposal for Calendar Reform.....Dec 20
 A Short Directory of Career Panels.....Aug 17
 A Spot by Any Other Name.....Aug 7
 An Approach to Callsign Analysis.....Dec 7
 An October Overlap.....Oct 20
 An Unofficial Glossary of Weasel
 Weasel Words (Golden Oldie).....Oct 10
 Answer to October Overlap.....Nov 21
 Answer to Puzzle No. 1.....Aug 20
 Answer to Puzzle No. 2.....Aug 18
 As We Go to Press.....Sep 7

 Calling All SRA's: Reporting Symposium?.....Aug 20
 Character-Building in the People's
 Republic of China.....Oct 7
 CISI Forming New Special Interest Group
 on Human Factors.....Dec 10
 Citizens of the World.....Dec 6
 Citizens of the World Answers.....Dec 12
 Coming Events.....Oct 15
 COMINT Analysis of [redacted].....Sep 1
 Contributions Solicited.....Sep 21
 Cryptanalysis & Code Recovery.....Sep 5
 CRYPTOLOG Index for 1974.....Dec 21

 Data & Definitions: Calling Things by
 Their Rightful Names.....Nov 1
 Department of Golden Oldies:
 An Unofficial Glossary of Weasel Words.....Oct 10
 King Eusyb & Queen Deodi.....Sep 19
 Management Survey of the Philharmonic.....Aug 20
 [redacted] What? Where? Why?.....Nov 5
 Even a 5-Year-Old Child... ..Oct 4

 Gary's Colors.....Sep 8
 Guidesmanship or How to Write Technical Manuals
 Without Actually Giving Anything Away.....Nov 18

 King Eusyb & Queen Deodi (Golden Oldie).....Sep 19

 Language in the News.....Sep 14
 Letter to the Editor.....Dec 9
 Lexicographic Corner: Some Thoughts on
 Lexicography.....Sep 11

 Maps in Mind: A Photoessay.....Dec 1

New Trends in the Teaching of Cryptanalysis:
 A Walk Through the '75 Curriculum.....Nov 5
 News from the School.....Oct 14
 Nice Busman's Holiday for One NSA Employee.....Aug 19

 Prizes & Honors from the Learned
 Organizations — Spring 1974.....Aug 21
 Project Carriage: Worldwide HFDF
 Modernization Plan.....Sep 9
 Purity of the Russian Language:
 Slavophiles vs. Westernizers.....Nov 12
 Puzzle No. 1.....Aug 10
 Puzzle No. 2.....Aug 13

 Reflections on a Translators' Conference.....Nov 10
 Right-to-Left Text Sorts Are Not Impossible.. Aug 14

 Secret Messages.....Dec 4
 Secrets of the Altars: The Moustier
 Cryptograms.....Sep 10
 Self-Paced Instruction: The Future Is Now!... Aug 15
 Some Thoughts on Lexicography.....Sep 11
 Subject: SRA Symposium... ..Oct 19

 TDB: The TEXTA Data Base.....Aug 4
 Telephone Recall.....Oct 6
 The Apostrophe: Some Thought's.....Nov 14
 The English Language in the News.....Dec 12
 The Language of Baseball in Everyday Talk.....Aug 11
 The Management Survey of the
 Philharmonic (Golden Oldie).....Aug 20
 The Mission of the Signals Processing
 Requirements Panel.....Oct 1
 The New Collection Criteria.....Dec 11
 The New Traffic Analysis Glossary.....Aug 8
 The Old [redacted] Section: Parts 3 & 4.....Dec 5
 The [redacted] Exercise: A Case Study in
 Special Research Analysis.....Oct 16

 Want Ad.....Dec 13
 What is a Collector?.....Aug 2
 What Should You Expect? or The Analysis
 of Cryptanalysts.....Aug 5
 Worldwide HFDF Modernization Plan:
 Project Carriage.....Sep 9

EO 1.4.(c)



~~CONFIDENTIAL~~

~~TOP SECRET~~

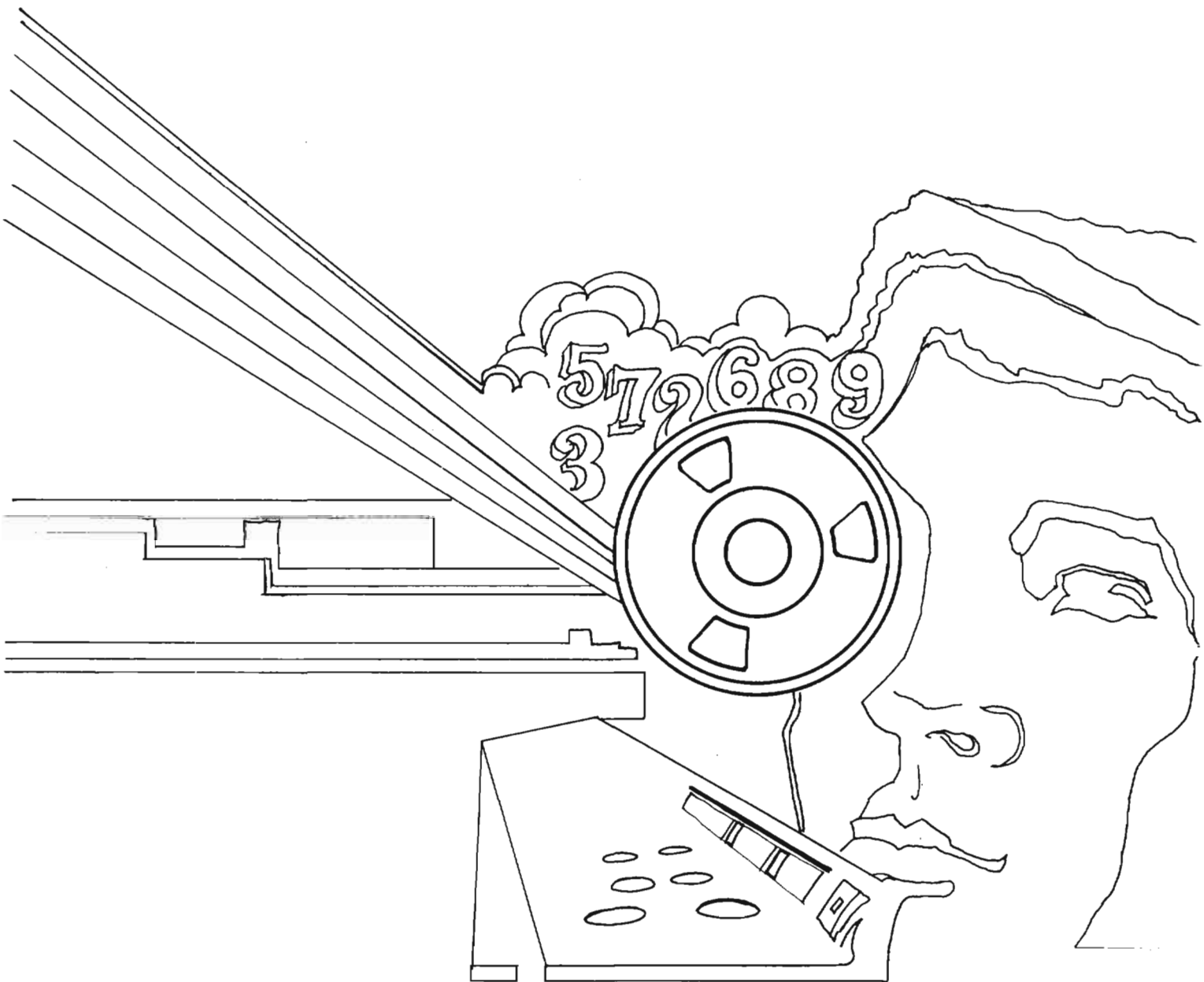

~~THIS DOCUMENT CONTAINS CODEWORD MATERIAL~~

~~TOP SECRET~~