

EVANS & SUTHERLAND COMPUTER CORPORATION

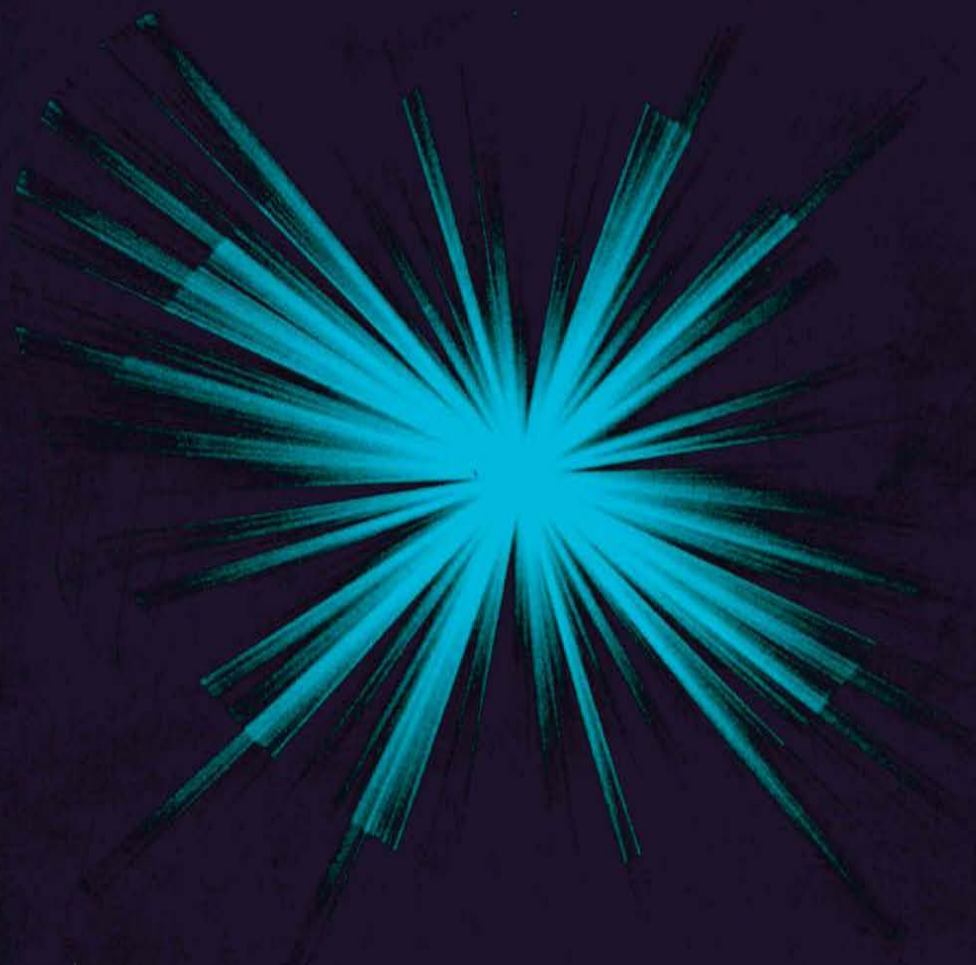

LDS-1/PDP-10

DISPLAY SYSTEM



digital equipment corporation **digital**

INTRODUCING THE LDS-1

The Evans & Sutherland Computer Corporation introduces a new high-performance Line Drawing Display System—the LDS-1—which promises to revolutionize computer graphics.

With the LDS-1, designers now have a graphics system that provides features formerly unobtainable: true perspective; a speed that produces true motion pictures instead of a series of stills; and a large dynamic range and zoom capability that allows the user to view an effective drawing area of one acre, then zoom in to study one square foot at high resolution.

The system easily displays complex two-dimensional pictures, including circuit diagrams, printed circuit layouts, molecular structures, architectural plans, and symbolic mathematical expressions—each represented in memory in a simple structured format. In addition, the system can produce graphs directly from unstructured tables of raw data.

In three dimensions, the LDS-1 displays perspective views of architectural drawings that can be rotated and studied from any angle so that an architect sees his product in true perspective before it is built. It can display three-dimensional mathematical curves or three-dimensional models of chemical molecules so that a scientist can understand phenomena that would otherwise be difficult to visualize. Moving terrain can be viewed from a simulated aircraft so that a pilot can obtain visual training. The display hardware not only computes the perspective view, but it automatically omits any lines or parts of lines behind the observer or outside the observer's field of vision.

The LDS-1 operates directly from the memory of a large general-purpose computer system—the PDP-10 manufactured by Digital Equipment Corporation. With its own stored program processor, the LDS-1 interprets the display code in memory and provides graphics parameters to its various hardware units that perform essential and repetitive graphics functions such as rotation, translation, windowing, and perspective division.

With hardware performing the bulk of graphics computation, the PDP-10 is free for other tasks. For example, it can provide true dynamic simulation of an object in motion by solving the appropriate differential equations; the resulting parameters are fed to the graphics processor which will display a continuously moving perspective picture in real time. Because graphics processing is fast, the software system can operate as many as four local scopes or it can return the processed pictures to memory for output on remote displays, plotters, or film writers. The PDP-10 can also be performing tasks totally unrelated to the display. It can serve up to 63 time-sharing terminals, process one or more batch streams, or even perform other real-time tasks.

The LDS-1 operates on a unique principle which enables the system to convert the data base information stored in PDP-10 memory, directly into lines for the scope, eliminating separate coding and the cumbersome display list. Such operation is made possible by a structuring of the data base that separates graphics code—essentially a table of individual lines in the drawing—and the coordinates for the end points of the lines. Coordinates are listed separately and are completely numerical. Coding can thus be thought of as a direct description of the drawing itself rather than a list of instructions for the display scope.

With the LDS-1, the description of the object is entirely separate from the point of view from which the object is observed. The coordinates determine whether the object exists in two- or three-dimensions, but hardware functions—scaling in two dimensions and perspective projection in three-dimensions—determine the magnification and viewing direction and, thus, what actually appears on the scope. To enlarge the subject, or view it from a new position, only the viewing parameters need be changed. The change appears instantaneously on the scope.

The combination of unique data base structure, hardware processing, and the flexibility of a general-purpose computer system provides many benefits. Structuring of the data base greatly simplifies display coding, producing shorter programs and simplifying modifications. Hardware processing allows the LDS-1 to process as many as 100,000 lines per second. With a multiplication time of 300 nsec, a complete matrix multiplication can be performed in 5 μ sec. Clipping takes 2 to 9 μ sec and scaling for the scope or perspective division is performed in less than 6 μ sec. The result is a system that is more than 100 times faster than displays that rely on software to perform these functions.

The PDP-10 adds still another dimension to system capability, allowing even more sophisticated graphics to be performed and allowing the system to be simultaneously used for interactive time-sharing, batch processing, and other real-time applications.

FEATURES

LDS-1

- Fast dynamic viewing
 - A motion picture, not a series of stills
 - Zoom that avoids loss of orientation
- True perspective
 - Obtained by hardware division
- Unlimited dynamic range
- Recursive use of symbols in different sizes and locations
- Processing for multiple displays
- Flexible graphics representation
 - Code describes object rather than scope instructions
 - Code and coordinates are separate—no bit packing
 - Same code can be used with any display device
 - Code can be debugged and assembled using PDP-10 software
 - Coordinates automatically provide for 2- or 3-D representation
 - Control stacks allow re-entrant subroutines
 - Graphs can be produced directly from tables of raw data
- Fast hardware processing
 - Up to 100,000 lines processed per second
 - Rotation and translation in $5 \mu\text{sec}$
 - Windowing in 2 to $9 \mu\text{sec}$
 - Perspective division in less than $6 \mu\text{sec}$
 - Asynchronous cascaded "pipeline" processing
 - Symbol scaling
 - Fast line drawing scope



PDP-10

SOFTWARE

- Three monitors
- Re-entrant software
- ASA FORTRAN IV and science library
- BASIC
- ASA level 2 COBOL
- Macro assembler
- AID, a derivative of the JOSS* language
- On-line debugging system
- Two editors
- Peripheral interchange program
- Batch processor

HARDWARE

- 36-bit word length
- 366 instructions
- Programmed operators
- Fast registers
- 16 accumulators/15 index registers
- Asynchronous operation
- High memory bandwidth (to 4 MHz)
- Direct addressing to 262,144 words
- Memory protection and relocation hardware
- Fast access head-per-track disks and drums
- Disk packs
- Flexible priority interrupt system
- Full range of communication equipment
- Easy interfacing

*JOSS is a trademark of the Rand Corporation.

LDS-1

The LDS-1 operates as an independent stored program processor, sharing memory with the PDP-10. In its complete form, the system contains all the high-speed digital arithmetic logic required to rotate, translate, window, and—in three dimensional operation—to place into perspective, the objects defined by the display program.

Unlike conventional displays which require entire pictures or parts of pictures to be computed before they are transmitted to the display, the LDS-1 performs these computations on a line-by-line basis as the display is being produced. Because of this line-by-line operation, a change in the scaling or perspective parameters will be reflected instantly as a change on the scope. Thus, for a moving picture, the LDS-1 assumes the entire burden of picture computation, requiring the PDP-10 to compute only the viewing parameters. If it is desirable, the viewing parameters can be changed for each frame to produce dynamic zoom in two dimensions or motion in three dimensions.

The LDS-1 system performs its functions using four major components: the Display Processor, the Matrix Multiplier, the Clipping Divider, and the Display Scope. This modularity allows the user to meet his particular graphic needs yet stay within his budgetary constraints. He can begin with a system consisting of a display processor and scope. With such a system, dynamic changes to the picture (normally performed by the matrix multiplier and clipping divider) are performed by the PDP-10.

Adding a Clipping Divider to the system provides automatic windowing, scaling, translation in two-dimensions, and three-dimensional perspective. The Matrix Multiplier provides further flexibility with fast rotation and translation of objects in three-space.

The LDS-1 system achieves its efficiency in part by employing cascaded asynchronous processing. The result is a "pipeline" effect in which each graphics processing unit is operating on a different picture line. While the scope is painting one line, the clipping divider is computing the next line, the matrix multiplier is processing the following line, and the display processor is fetching still another line, all simultaneously.

In addition to servicing up to four local displays, the system can return the output of the matrix multiplier and the clipping divider to memory to be stored or transmitted via phone wires to remote displays, plotters, or film writers. Output is automatically scaled to fit the coordinate system of the device and pictures can be as large as the resolution of the output device allows.

DISPLAY PROCESSOR

The display processor is a stored program computer, much like the PDP-10 central processor, with an instruction repertoire specialized toward line drawing rather than general computing.

Unlike conventional display systems that intermix data with display control information, the LDS-1 operates on coordinates which are purely numerical and completely separate from the display program. Since code and coordinates are separate, there is no need for bit packing. Code is also independent of scope coordinates, allowing the same code to be used with any display device.

Structuring the data base in this manner makes it easy to compile and to change the picture definition—formerly a tedious and time-consuming task. For example, a circuit diagram component can be moved and all the wires connected to it will automatically remain attached.

Coding is performed by any of four methods: by specifying each line as an address reference to two sets of coordinates, by connecting a table of the desired points in series, by defining geometrically similar objects as symbols, and by using interpreted specifications to provide a very compact notation for arrays, cross-hatched boxes, or other symbolic representations which require multiple parameters.

Defining geometrically similar objects as symbols allows the display program to operate on the same basic coordinate data to produce the same object in different sizes and in various locations throughout the picture. Symbols are automatically clipped when they reach the edge of the viewing area. This feature, implemented by multi-level subroutines with pushdown stack control, does much to simplify programming.

The processor also contains control and conditional instructions that direct the computational activity of the arithmetic units, perform geometrical tests, and execute iteration loops to define periodic drawing features.

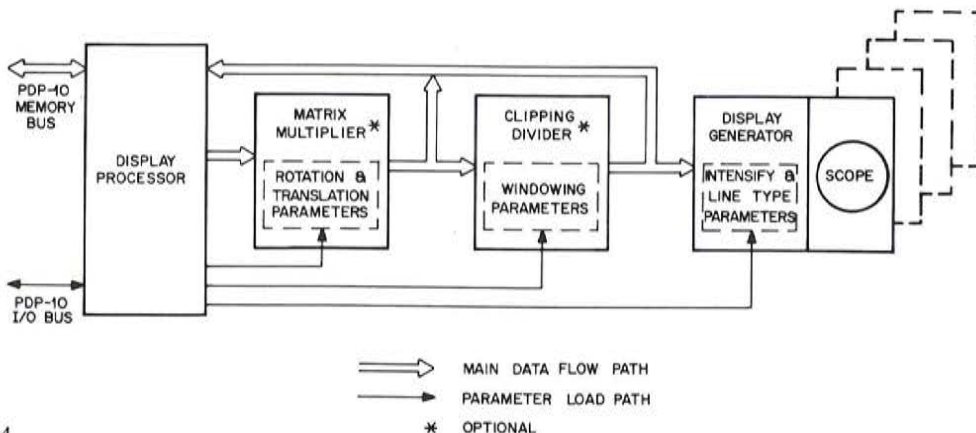

MATRIX MULTIPLIER

The optional matrix multiplier can produce user-controlled moving views of three-dimensional objects, tumbling them in real-time, and can automatically generate curved lines and surfaces directly from a matrix specification. The matrix multiplier multiplies a 1×4 vector by a 4×4 matrix in five microseconds.

The use of a four-by-four matrix allows both translation and rotation to be represented in a single matrix, providing a very simple mechanism for describing and analyzing three-dimensional transformations. The single matrix form not only makes it easier to analyze these transformations, but also radically shortens the required programs. For example, if the relationship between each of two moving objects and the ground is known, the relationship of one object to the other can be derived by performing a single matrix multiplication. The four-by-four matrix representation, based on homogeneous coordinates, also allows the data base to include far distant objects with nearby objects to produce a truly infinite dynamic range.

CLIPPING DIVIDER

The clipping divider lets the user select the area, the scale, and the position of the presentation. In two dimensional displays, the portion of the drawing to be displayed is delineated by specifying a rectangular "window" on the definition space. The clipping divider filters material for the display through this window, transmitting only those lines or parts of lines which lie within the window. The material that appears in the window is mapped onto a specified rectangular region of the scope called a "viewport". Window and viewport proportions can be radically different to squeeze or stretch a given "windowed" item. Multiple views can easily be presented on the scope through separate viewports.

The clipping divider also provides the scaling needed for presenting symbols in any size anywhere in the picture. Symbol scaling is combined automatically with picture scaling to produce a composite scale which is used during processing of the symbol subroutine. Any picture defined for the LDS-1 can be used as a symbol in another picture. Symbols not visible on the display are skipped without time consuming interpretation of their definitions.

Operation of the clipping divider is similar for three dimensions, except that the window is a pyramid in 3-space. All dots and lines within the pyramid of vision are projected through the origin to produce a perspective view which is then mapped onto the viewport. Objects behind the observer are automatically eliminated.

In perspective presentation, the clipping divider eliminates the overflow problems inherent in the division operation by first clipping and removing all lines that lie outside the pyramid of vision. Clipping is performed by the divider hardware at a rate of 2 to 9 μsec per line, as opposed to a software rate of about 1 msec per line. Thus, truly dynamic perspective viewing is available for the first time.

The clipping divider can also be used to provide the important "pointing" function with tablet input devices. Although the tablet provides only a coordinate, the clipping divider can put into memory a list of those picture parts which pass through or near that coordinate. The software required to perform the clipping divider's function would be costly to write and time consuming to operate.

DISPLAY GENERATOR AND SCOPE

The display generator and scope consist of a digital-to-analog conversion array, a line generator, and the display scope. Input to the display generator is digitally-specified discrete dots or straight lines. The analog line generator in the display draws continuous lines from any point on the screen to any other point. The time required per line varies from 5 to 50 μsec , depending on line length. The line generator can drive as many as four scopes with independent unary selection.

Since the graphics coordinates in PDP-10 memory are independent of the scope, programmers need not think in terms of scope coordinates. The same display program automatically produces coordinates for any display device. The scope provided has 12-bit digital-to-analog conversion, but the clipping divider provides scope coordinates that are accurate to 18 bits, so that the system is capable of handling plotters or other display equipment of greater accuracy.

The display scope has a high resolution area of ten inches square with a typical spot size of 0.020 inches. The scope is mounted on a moveable cart which may be located up to 50 feet from the display generator.

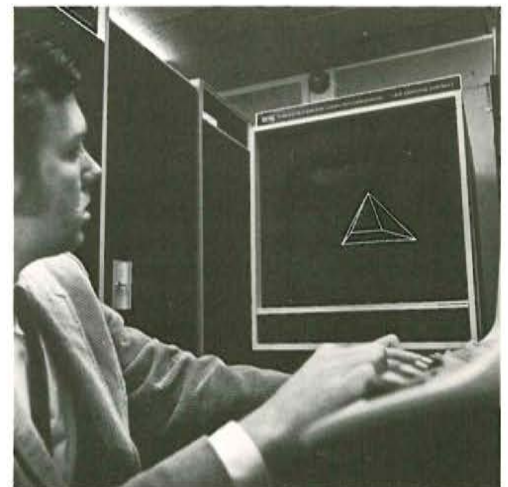

PDP-10

Operating the LDS-1 display is only one of the tasks that the PDP-10 can perform. At the same time that the display is in operation, graphics and other programs can be developed on-line by as many as 63 simultaneous users; batch processing can be performed for multiple program streams, or the system can handle other real-time tasks.

PDP-10 system features ideally match LDS-1 requirements. For example, the 36-bit word length of the PDP-10 allows users to specify the x,y data for a point by using the two 18-bit halves of a single word. Although 10 to 12 bit accuracy is sufficient for conventional displays, the LDS-1 uses the 18-bit half-word for good resolution when two-dimensional pictures are highly magnified. In three-dimensions, the 18-bit accuracy is used to show a true perspective view of objects which are close to the observer.

The PDP-10's large and versatile instruction set includes 64 half-word instructions providing a powerful tool for manipulation of the 18-bit data display format.

The PDP-10 offers four-port 1.0 and 1.8 μ sec memory units on a bus system which permits up to 256 K of memory to operate asynchronously and independently. Thus display and computational functions can be completely over-lapped. Both the central processor and the display processor can operate simultaneously on one million full 36-bit words per second. The two remaining ports allow additional processors or high speed input/output devices to operate at the same one million words/second rate, giving a maximum memory bandwidth of four million words/second.

Other hardware features of the PDP-10 include sixteen general-purpose registers which can be used as accumulators, index registers, and/or normal memory locations; memory protection and relocation hardware; and a hardware multi-level priority interrupt system which is programmable for flexibility.

Three compatible monitors — any one of which can be used with the LDS-1 display — and a wide range of peripherals make possible many expandable system configurations. Starting with a dedicated system, the user can expand to provide multi-programming by merely installing a new monitor. A swapping monitor further increases core utilization by swapping user programs between high-speed disk or drum storage and core memory.

Other software includes FORTRAN IV, BASIC, AID, COBOL, a macro assembler, a context editor, a symbolic debugging system, a peripheral interchange program, a desk calculator, and FORTRAN library programs. Most software is re-entrant, so that a single compiler can serve many users simultaneously, allowing more users to reside in core at the same time and providing better system response.

Peripheral choices include three types of disk systems, magnetic tape units, DECTape systems, line printers, card readers and punches, communications equipment, CRT displays, plotters, and real-time interface equipment.

As today's most cost/effective system, the PDP-10 is an excellent companion to the LDS-1.



THE LDS-1/PDP-10 SYSTEM

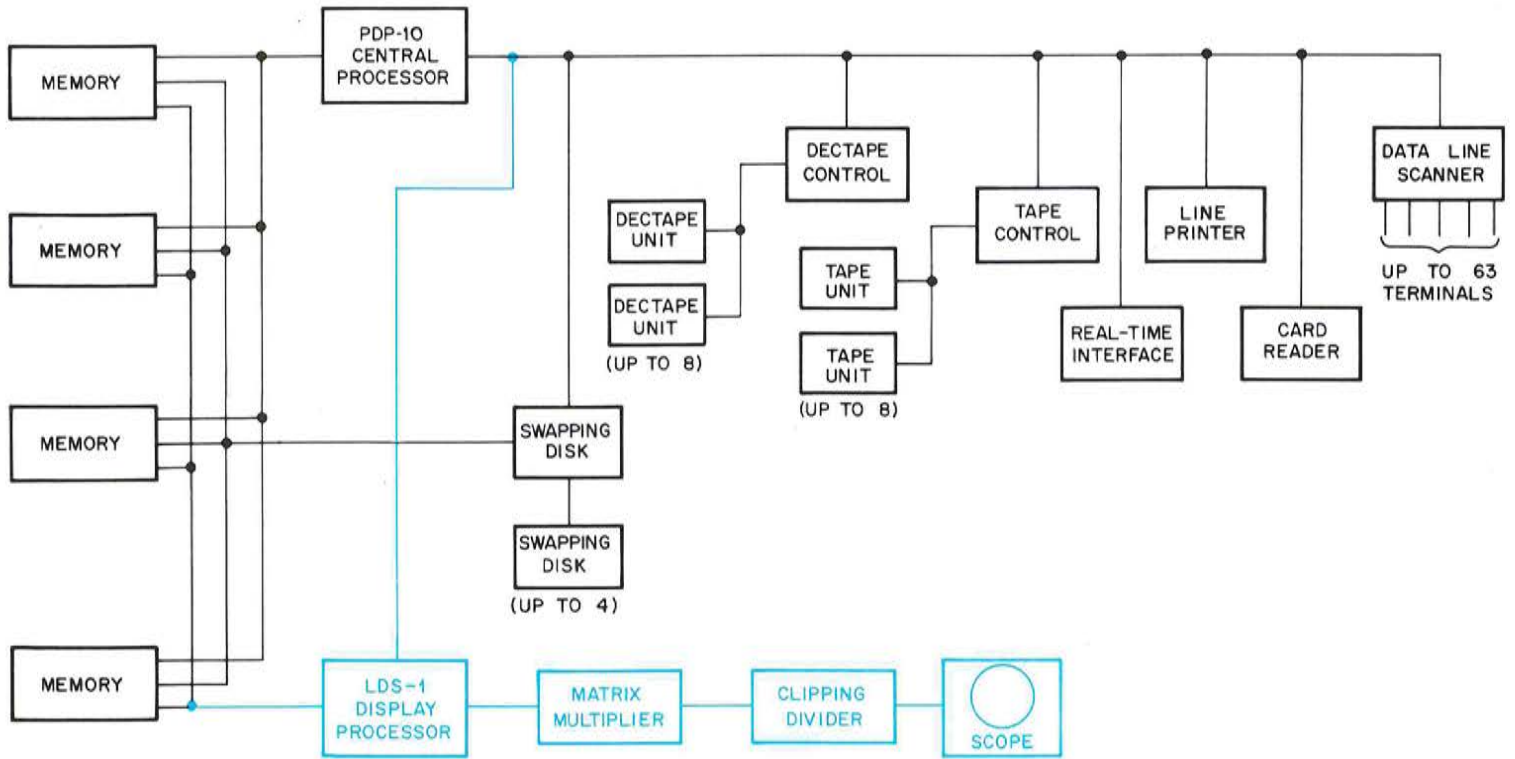

The LDS-1 display system and the PDP-10 general-purpose computer combine to form an extremely powerful and versatile system for interactive graphics and computer-aided simulation. At the same time, the combined system provides extensive facilities for terminal time-sharing, batch processing, and real-time data acquisition and analysis.

The LDS-1 interfaces directly to the memory of the PDP-10, operating as an autonomous processor which is started and stopped by PDP-10 input/output instructions. The LDS-1 refreshes the display dynamically from data that is loaded into PDP-10 memory or generated by the PDP-10. The PDP-10 can control the operation of the LDS-1 either by changing the content of memory or by direct intervention through the I/O bus. Similarly, the LDS-1 can communicate special needs to the PDP-10 either through memory or over the I/O bus. Most communication between the two processors is accomplished through memory.

In normal operation, the PDP-10 arithmetic processor starts the display, then proceeds to other tasks, stopping only to service interrupts caused by the display. Typical interrupts might request arithmetic calculations, call a display file from a file-oriented device, or request an updating of the data structure being displayed. Since the LDS-1 requires assistance infrequently, the PDP-10 can spend a large percentage of its time performing terminal time-sharing, batch processing, and real-time tasks.

Since the display processor uses PDP-10 instruction format, a key item in the software package is an extended version of the MACRO-10 assembly language. The package includes operator definitions, definitions of constants, and the macros required to assemble relocatable code for the LDS-1/PDP-10 system. The PDP-10's on-line debugging system—DDT—is also useful for debugging of display code.

A basic utility subroutine package contains programs for starting the display, stopping the display and saving the display program state, restarting a saved program, and changing programs. Other utility routines display the saved program state, provide interrupt handling, and assist in testing the hardware. The system does not require the usual library of programs to perform geometrical calculations, since these functions are performed by LDS-1 hardware.

Distribution of new programs and sharing of existing software is actively encouraged by the Evans & Sutherland Computer Corporation and DECUS—the Digital Equipment Computer Users Society. However, users with special applications or who wish to generate displays using higher level languages should expect to develop their own software.

GRAPHICS APPLICATIONS

Applications for the LDS-1/PDP-10 system are bounded only by the user's imagination. With its inherent versatility and power, the system infinitely widens the number of graphics tasks that can be performed easily and efficiently. For the first time, the user can develop true motion pictures, zoom in to review detailed material in a massive drawing without losing orientation, and easily rotate complex three-dimensional objects to study their shape and characteristics. The following application suggestions should merely stimulate the reader's imagination ... the possibilities are limitless.

AIRCRAFT SIMULATION

The LDS-1 is the only computer display capable of presenting the dynamic perspective views required for pilot training simulations. Perspective viewing is absolutely essential if the airport is to become larger as the simulated aircraft attempts to land. The ability to process approximately 3000 lines flicker-free and in perspective, without any use of the PDP-10 central processor, allows the LDS-1 to present very complex visual terrain models. The PDP-10 can devote full time to the simulation of aircraft motion while the LDS-1 performs the visual computations.

If multiple moving objects are to be presented, LDS-1's ability to form composite transformations is very useful. If, for example, the model includes five other moving aircraft, the PDP-10 computes only the relationships of the other planes to the ground; the LDS-1 combines this information with information on the viewer's position relative to the ground in order to relate the viewer directly to the positions of the other aircraft. Because the combining of such transformations is recursive, the system easily represents complex operations in which parts of an object move with respect to other parts. For example, it is simple to portray a moving radar antenna on the ground or on another aircraft.

AIR TRAFFIC CONTROL

The LDS-1 can be used to plot the paths of moving aircraft, viewing each vehicle on the screen in true perspective. Each aircraft can be labeled for identification. Since the scene can be examined from any direction, the viewer can check latitude, longitude, and elevation to determine whether any of the aircraft will collide in following their predetermined paths. The variable scope intensity feature can be used to program aircraft trails which fade out behind the aircraft.

DISPLAY OF MOLECULAR STRUCTURE

The LDS-1 makes it simple to model molecular structures and rotate the model for complete study. Data definition is easy since the locations of atoms need be described only once. The bonds between the atoms are formed by defining a "bond table" with address pointers to the atoms that are to be connected together. Individual atoms are relocated in space by merely changing their coordinates; the bonds attached to them automatically stay attached. Molecules may be displayed in either two or three dimensions.

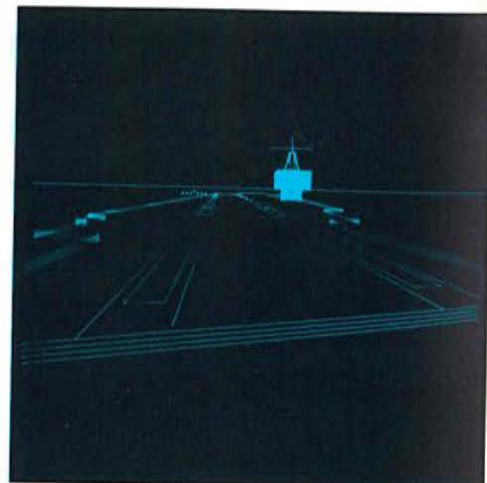
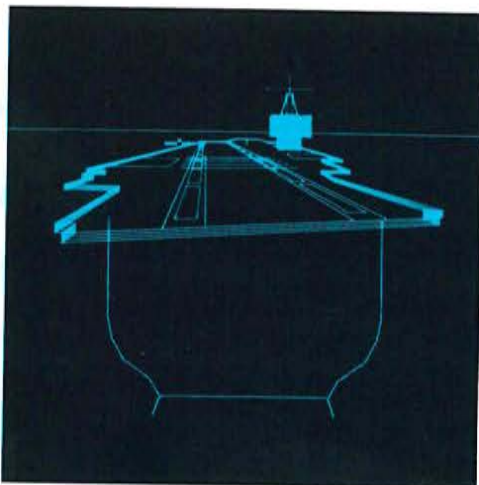
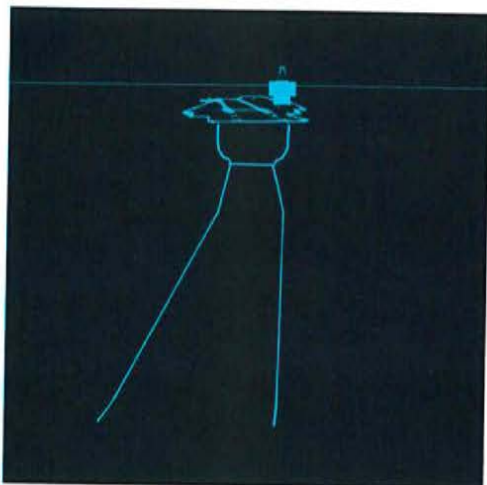

MOVIE MAKING

In movie making, the LDS-1 can serve as an aid to the development of motion pictures. By simulating proposed sets, a director can determine set efficiency, camera angles, and light direction, allowing him to make a detailed analysis of the elements of his production before making the film.

In cartooning, the LDS-1's ability to produce dynamic motion as well as zoom and rotation make it possible to see the motion picture "live" on the screen without intermediate and costly film processing. The cartoonist can vary the action, change "camera" angles, and then view the results immediately. Filming can be accomplished directly from the display scope, or by returning the pictures to memory for transfer to a conventional film recorder.

CIRCUIT DESIGN

The symbol capability of the LDS-1 is important in circuit design. Once circuit symbols are defined and stored, they can be used repeatedly in desired sizes and locations. The symbols can be mirror-imaged automatically and any sub-circuit can be used as a circuit symbol with multiple magnifications possible. Thus miniature gates can be included in a flip flop and will appear and be readable when the picture is magnified. The wires attached to the symbols remain attached when the symbol is moved, because wires are defined by address references to component coordinates.

PRINTED CIRCUIT BOARD LAYOUT

The layout of a large printed circuit board is usually so complex that the details are just not visible on an ordinary display. With LDS-1 scaling, the layout can easily be magnified for checking and modification. Several views may be placed on the screen at the same time: for example, an overall view at the top and two detailed views below. With this arrangement, new wires can be placed accurately in the bottom views and overall routing can be checked with the top view. Since all new wires are part of the model, they automatically appear correctly in all views.

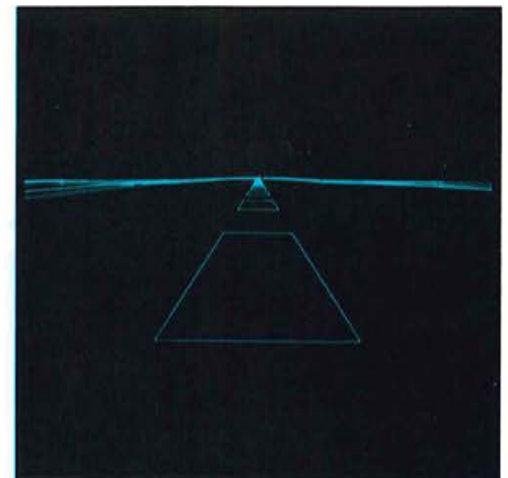
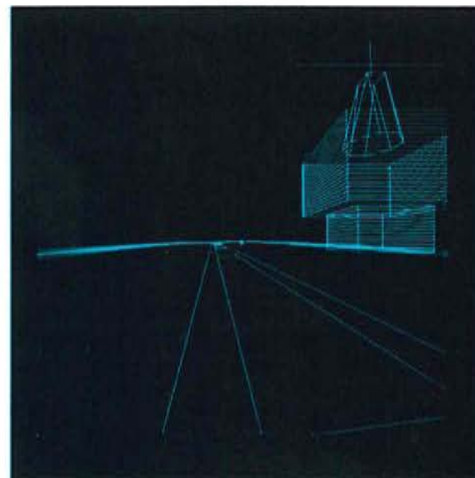
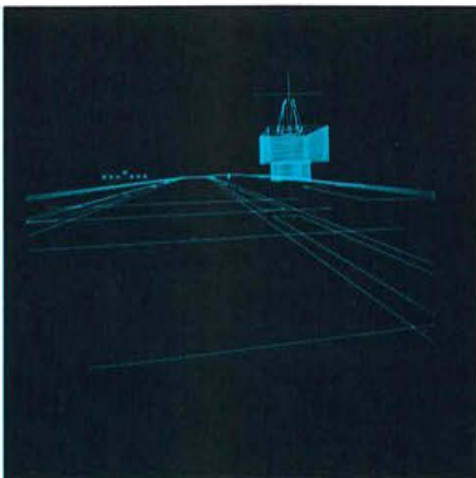

MORE GRAPHICS APPLICATIONS

ARCHITECTURE

One of the LDS-1 features important to architecture is the subroutining capability that makes it possible to define a window or other structure only once and display it in the structure as many times as required. Changes to the definition will immediately be reflected in each of the multiple images. The structure can be rotated and moved with respect to the observer, allowing him to check its appearance from different points of view.

Many architectural designs that are difficult or impossible to model are now possible with the LDS-1. For example, if parts of the structure move with respect to other parts, as in moving bridges, doors, hangings, elevators, etc., the motion can be shown dynamically on the LDS-1.

SPACE LAYOUT

With the LDS-1, many difficult layout problems can be solved without complicated calculation or actual experimentation. For example, to discover whether a machine will fit a given space, the system can model it in three dimensions, complete with linkages, so that the extent of its motion can be observed. Thus oversights can be discovered in a design before it is committed to metal.

The ability of the LDS-1 to handle rotation and translation of individual parts with respect to each other greatly simplifies the programming of complex linkages. Since parts can be designated as symbols, each part can be described separately and the display system can put them together. The fact that hardware performs these computations is essential to making the linkage move on the screen in real-time.

LAND USE ANALYSIS

In land use analysis, the dynamic range of the LDS-1 is important. Large geographic areas must be displayed, yet scaling must accurately show the finer details of land use. With the LDS-1, features on a square foot can be distinguished in an area the size of New York City's Manhattan Island.

LAND CONTOUR STUDIES

The LDS-1 can represent land surface shape as a series of surface patches according to simple mathematical descriptions. The viewer can observe the land from any angle, determining the view encompassed by a particular radar site, or by a person standing at a particular location; or, the viewer can observe the entire surface of the land as if he were viewing it from a moving vehicle. This technique should be particularly effective in highway visibility studies.

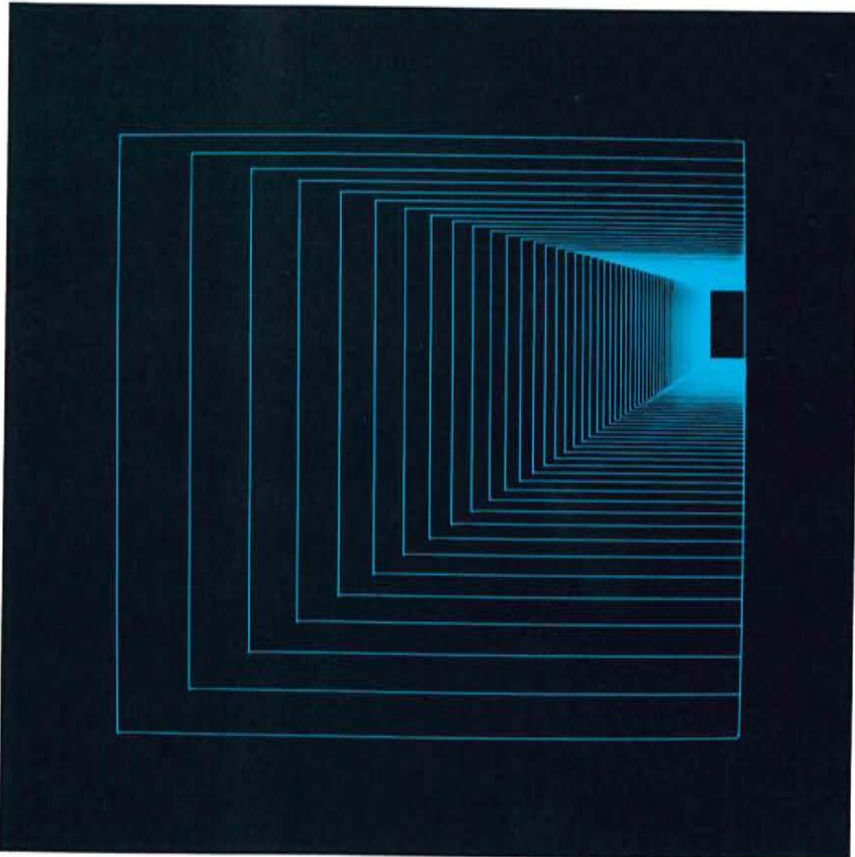

SCULPTURED PARTS

With the LDS-1, designers can see the shapes of complex sculptured parts before they build them. Using difference equation methods, the system can directly represent curved surfaces as complex three-dimensional shapes. The hardware not only draws the correct perspective view, but also generates a complex representation of the surface patch from simple parametric specifications. Because the shapes are described mathematically in the computer, they can easily be converted to a format usable for numerical tool control. Moreover, once the shape is defined, PDP-10 programs can compute such factors of the shape as weight, balance, strength, and aerodynamic or hydrodynamic characteristics.

N.C. TOOL PROGRAMMING

LDS-1 magnification features are invaluable for quick checking and changing of N.C. tool programs. Problem areas in the tool path plot can be easily identified in an overall view and the zoom feature can enlarge any portion of the tool path for detailed examination and correction. Details can be magnified so that one-thousandth of an inch in the tool path becomes a half inch on the display with accuracy strictly maintained. After the detail is corrected, the overall view can again be used to review the situation.

DATA ANALYSIS

Since the LDS-1 uniquely separates tables of numbers from display commands, it can display a graph directly from a simple table of data. Because the display performs scaling internally, there is no need to scale all of the numbers by software. Moreover, the hardware can provide increments in x (or y) between points. The resulting graph can be greatly expanded so that the finer details can be displayed and studied.

Data can also be displayed in three dimensions. If a three-dimensional object is continuously rotated on the scope, the "kinetic depth effect", a well-known property of human vision, will help the viewer interpret the object's shape and provide insight not possible with a collection of two-dimensional drawings. With scaling, interesting portions of the three-dimensional object can be magnified, or each axis can be scaled independently using a different magnification in x than in y, to improve understanding.

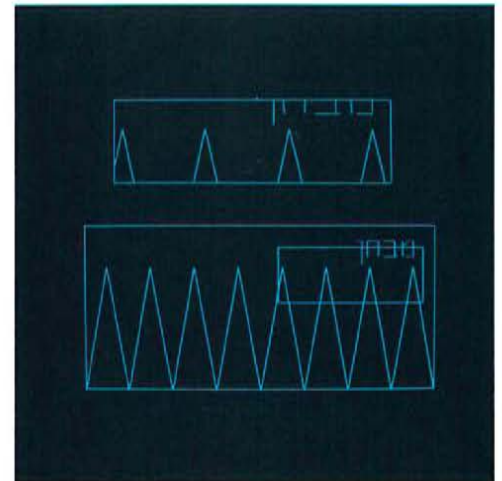
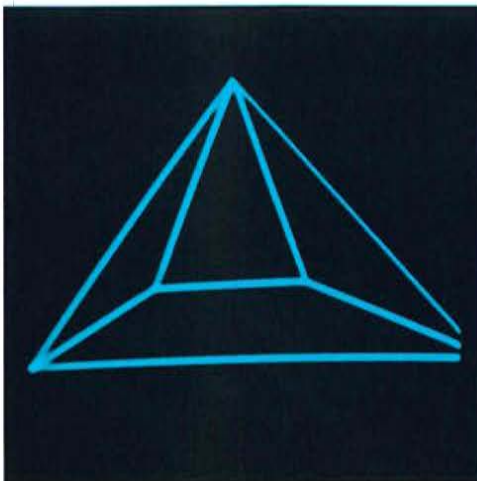

ABOUT THE COMPANIES

EVANS & SUTHERLAND COMPUTER

CORPORATION, founded in 1968 by Dr. David C. Evans and Dr. Ivan E. Sutherland, specializes in the design and manufacture of graphic systems. Delivery of the first LDS-1 was made in August, 1969, 10 days ahead of schedule. Production of LDS-1 systems is now scheduled on a regular basis and additional products are under development.

The firm's research, development and manufacturing facility is located in a research park adjacent to the University of Utah, Salt Lake City, allowing it to draw upon the resources of the University's Information Research Laboratory, a recognized center for research in computer graphics and man-machine systems. Dr. Evans and Dr. Sutherland participate directly in this research as faculty members of the university.

Dr. David C. Evans, founder and chairman of the board, is a recognized pioneer in the development of on-line systems and computer graphics. As Director of Computer Science at the University of Utah, he is principal investigator in one of this country's largest and most successful research programs in graphics and interactive computing systems. Previously, he was principal investigator of Project Genie, a similarly-directed program which developed one of the first, and most successful, time-shared computer systems at the University of California's Berkeley campus.

Prior to Project Genie, Dr. Evans was Director of Engineering at the Computer Division of the Bendix Corporation and responsible for developing the G-15 and G-20 computer systems. Dr. Evans thus brings the company extensive experience in the design and manufacture of computer systems as well as in the research of man-machine systems.

Dr. Ivan E. Sutherland, co-founder and president of the company, developed the first modern computer graphics system as part of his doctoral research at Massachusetts Institute of Technology in 1960. "Sketchpad", as the system was called, demonstrated many of the facilities now provided in real-time and at less cost by the new Evans & Sutherland display system.

From 1964 to 1966, Dr. Sutherland was in charge of computer research for the Office of the Secretary of Defense. As Director for Information Processing Techniques for the Advanced Research Projects Agency, he managed the government's \$15,000,000 a year allotment to projects investigating man-machine systems. Prior to the founding of Evans & Sutherland, he was Associate Professor of Electrical Engineering at Harvard University where the research he conducted contributed heavily toward the advancement of display technology.

DIGITAL EQUIPMENT CORPORATION

originated in 1957 as a manufacturer of low-cost digital logic modules. Since the introduction of its first computer, the PDP-1, the firm has pioneered in the development and application of low-cost scientific computers for real-time and time-sharing applications. Among its noteworthy achievements are: the PDP-8, the first general-purpose computer to sell for under \$20,000; the PDP-8/S and PDP-8/L, the first high production volume general-purpose computers for under \$10,000; and the PDP-6, the first complete time-sharing system to be developed by a manufacturer.

DIGITAL has also maintained its pre-eminent position in the development of high-volume, low-cost modules, in building K-series modules for noisy industrial environments and logic laboratories for student use.

The PDP-10 general-purpose computer system — DIGITAL's largest product — has won wide acceptance for both real-time and time-sharing applications. Among its users are industrial corporations, financial institutions, university computing centers and departments of computer science, researchers in the fields of physics and biomedicine, and time-sharing service bureaus.

Since 1957, Digital Equipment Corporation has grown from three employees to a staff of over 4,500 located throughout the United States and in ten other countries. Present manufacturing facilities occupy over 1,000,000 square feet, with more than 560,000 square feet under construction. Plants are located in Maynard, Massachusetts; Carleton Place, Ontario, Canada; Reading, England; and San German, Puerto Rico; with new plants being built in Westfield and Leominster, Massachusetts. Field offices are shown on accompanying pages.

PURCHASING AN LDS-1/PDP-10 SYSTEM

Evans & Sutherland Computer Corporation and Digital Equipment Corporation have combined resources to provide a fully-integrated LDS-1/PDP-10 system supported by both service organizations. Although the two companies sell, warrant, and service their systems independently, your local DIGITAL account representative will be happy to answer questions regarding either system and provide liaison with the Evans & Sutherland staff. Separate maintenance contracts are available.

Customers with existing PDP-10's (or PDP-6's) may order an LDS-1 display directly from the Evans & Sutherland office in Salt Lake City. Customers requiring complete systems may obtain assistance in specifying and ordering both the display and the PDP-10 from their local DIGITAL sales office.

System delivery, integration, and acceptance will be handled as follows:

- The PDP-10 is delivered first. After the PDP-10 has been installed and tested, a full customer acceptance test will be run on both hardware and software. Payment for the PDP-10 is due upon completion of this test.

- The LDS-1 system arrives after PDP-10 test completion, is interfaced to the PDP-10, checked out, and receives its own acceptance test. Upon test completion, payment is due for the LDS-1. A DIGITAL software support specialist will then assist the Evans & Sutherland staff in integrating the display software into the PDP-10 monitor system.

To fully assess the capabilities of the system, prospective customers may wish to visit one of the LDS-1/PDP-10 systems already in operation. Such visits are welcomed and may be arranged by contacting a marketing representative of Evans & Sutherland, either directly or through the local DIGITAL account representative.

EVANS & SUTHERLAND COMPUTER CORPORATION

3 Research Road
Salt Lake City, Utah 84112
Telephone: (801) 322-5847

dash between area code and "322"

DIGITAL EQUIPMENT CORPORATION

CORPORATE HEADQUARTERS
146 Main Street, Maynard, Massachusetts 01754
Telephone: From Metropolitan Boston: 646-8600
Elsewhere: (617) 897-5111
TWX: 710-347-0212 Cable: Digital Mayn. Telex: 94-8457

USA.

dash between area code and "897" like all others below.

U.S. SALES

NORTHEAST

REGIONAL OFFICE:

15 Lunda Street, Waltham, Massachusetts 02154
Telephone 891-1030 & 1633

WALTHAM OFFICE:

15 Lunda Street, Waltham, Massachusetts 02154
Telephone 891-6310 & 6315

CAMBRIDGE/BOSTON OFFICE:

899 Main Street, Cambridge, Massachusetts 02139
Telephone (617)-491-6130 TWX: 710-320-1167

ROCHESTER OFFICE:

130 Allens Creek Road
Rochester, New York 14618
Telephone (716)-461-1700 TWX: 510-253-3078

CONNECTICUT OFFICE:

1 Prestige Drive, Meriden, Connecticut 06450
Telephone: (203)-237-8441 TWX: 710-461-0054

MID-ATLANTIC — SOUTHEAST

REGIONAL OFFICE:

U.S. Route 1, Princeton, New Jersey 08540
Telephone: (609)-452-9150 TWX: 510-685-2338

NEW YORK OFFICE:

Suite #1
71 Grand Avenue, Palisades Park, New Jersey 07650
Telephone: (201)-941-2016 or (212)-594-6955
TWX: 710-992-8974

NEW JERSEY OFFICE:

1259 Route 46, Parsippany, New Jersey 07054
Telephone: (201)-335-3300 TWX: 710-987-8319

PRINCETON OFFICE:

Route One and Emmons Drive,
Princeton, New Jersey 08540
Telephone: (609)-452-2940 TWX: 510-685-2337

LONG ISLAND OFFICE:

1919 Middle Country Road
Centereach, L.I., New York 11720
Telephone: (516)-585-5410 TWX: 510-228-6505

PHILADELPHIA OFFICE:

1100 West Valley Road, Wayne, Pennsylvania 19087
Telephone: (215)-687-1405 TWX: 510-668-4461

MID-ATLANTIC — SOUTHEAST (cont.)

WASHINGTON OFFICE:

Executive Building
7100 Baltimore Ave., College Park, Maryland 20740
Telephone: (301)-779-1100 TWX: 710-826-9662

CHAPEL HILL OFFICE:

P.O. Box 1186, Chapel Hill, North Carolina 27514
Telephone: (919)-929-4095 TWX: 510-920-0763

HUNTSVILLE OFFICE:

Suite 41 — Holiday Office Center,
3322 Memorial Parkway S.W., Huntsville, Ala. 35801
Telephone: (205)-881-7730 TWX: 810-726-2122

ORLANDO OFFICE:

Suite 232, 6990 Lake Ellenor Drive, Orlando, Fla. 32809
Telephone: (305)-851-4450 TWX: 810-850-0180

ATLANTA OFFICE:

Suite 116, 1700 Commerce Drive, N.W.
Atlanta, Georgia 30318
Telephone: (404)-351-2822 TWX: 810-751-3251

KNOXVILLE OFFICE:

5731 Lyons View Dr., S.W., Knoxville, Tenn. 37919
Telephone: (615)-588-6571 TWX: 810-583-0123

CENTRAL

CENTRAL REGION OFFICE:

1850 Frontage Rd., Northbrook, Illinois 60062
Telephone: (312)-498-2560 TWX: 910-686-0655

PITTSBURGH OFFICE:

400 Penn Center Boulevard,
Pittsburgh, Pennsylvania 15235
Telephone: (412)-243-8500 TWX: 710-797-3657

CHICAGO OFFICE:

1850 Frontage Rd., Northbrook, Illinois 60062
Telephone: (312)-498-2500 TWX: 910-686-0655

ANN ARBOR OFFICE:

230 Huron View Boulevard,
Ann Arbor, Michigan 48103
Telephone: (313)-761-1150 TWX: 810-223-6053

MINNEAPOLIS OFFICE:

15016 Minnetonka Industrial Road
Minnetonka, Minnesota 55343
Telephone: (612)-935-1744 TWX: 910-576-2818

INDIANAPOLIS OFFICE:

21 BEACHWAY DRIVE, SUITE G

Indianapolis Indiana 46224 Telephone (317)-243-8341 TWX: 810-341-342

CENTRAL (cont.)

CLEVELAND OFFICE:

Park Hill Bldg., 35104 Euclid Ave.
Willoughby, Ohio 44094
Telephone: (216)-946-8484 TWX: 810-427-2608

ST. LOUIS OFFICE:

Suite 110
115 Progress Parkway
Maryland Height, Missouri 63042
Telephone: (314)-872-7520 TWX: 910-764-0831

DAYTON OFFICE:

3101 Kettering Blvd., Dayton, Ohio 45439
Telephone: (513)-299-7377 TWX: 810-459-1676

DALLAS OFFICE:

1625 W. Mockingbird Lane, Suite 309
Dallas, Texas 75235
Telephone: (214)-638-4880

HOUSTON OFFICE:

3417 Milam Street, Suite A, Houston, Texas 77002
Telephone: (713)-524-2961 TWX: 910-881-1651

WEST REGIONAL

WESTERN OFFICE:

560 San Antonio Road, Palo Alto, California 94306
Telephone: (415)-328-0400 TWX: 910-373-1266

ANAHEIM OFFICE:

801 E. Ball Road, Anaheim, California 92805
Telephone: (714)-776-6932 or (213)-625-7669
TWX: 910-591-1189

WEST LOS ANGELES OFFICE:

2002 Cotner Avenue, Los Angeles, California 90025
Telephone: (213)-479-3791 TWX: 910-342-6999

SAN FRANCISCO OFFICE:

560 San Antonio Road, Palo Alto, California 94306
Telephone: (415)-326-5640 TWX: 910-373-1266

ALBUQUERQUE OFFICE:

6303 Indian School Road, N.E.
Albuquerque, N.M. 87110
Telephone: (505)-296-5411 TWX: 910-989-0614

DENVER OFFICE:

2305 South Colorado Blvd., Suite #5
Denver, Colorado 80222
Telephone: (303)-757-3332 TWX: 910-931-2650

SEATTLE OFFICE:

1521 - 130th N.E., Bellevue, Washington 98004
Telephone: (206)-454-4058 TWX: 910-443-2306

SALT LAKE CITY OFFICE:

431 South 3rd East, Salt Lake City, Utah 84111
Telephone: (801)-328-9838 TWX: 910-925-5834

INTERNATIONAL SALES

CANADA

HEADQUARTERS (?)

CANADIAN OFFICE:
Digital Equipment of Canada, Ltd.
150 Rosamond Street, Carleton Place, Ontario
Telephone: (613)-257-2615 TWX: 610-561-1651

OTTAWA OFFICE:
Digital Equipment of Canada, Ltd.
120 Holland Street, Ottawa 3, Ontario
Telephone: (613)-725-2193 TWX: 610-562-8907

TORONTO OFFICE:
Digital Equipment of Canada, Ltd.
230 Lakeshore Road East, Port Credit, Ontario
Telephone: (416)-278-6111 TWX: 610-492-4306

MONTREAL OFFICE:
Digital Equipment of Canada, Ltd.
640 Cathcart Street, Suite 205, Montreal, Quebec
Telephone: (514)-861-6394 TWX: 610-421-3690

EDMONTON OFFICE:
Digital Equipment of Canada, Ltd.
5531-103 Street
Edmonton, Alberta, Canada
Telephone: (403)-434-9333 TWX: 610-831-2248

GERMANY

COLOGNE OFFICE:
Digital Equipment GmbH
5 Koeln, Bismarckstrasse 7, West Germany
Telephone: 52 21 81 Telex: (84) 888-2269
Telegram: Flip Chip Koeln

MUNICH OFFICE:
Digital Equipment GmbH
8000 Muenchen 19, Leonrodstrasse 58, West Germany
Telephone: 516 30 54 Telex: (84) 524226

ENGLAND

READING OFFICE:
Digital Equipment Co., Ltd.
Arkwright Road, Reading, Berkshire, England
Telephone: Reading 85131 Telex: 84327

MANCHESTER OFFICE:
Digital Equipment Co., Ltd.
13/15 Upper Precinct, Walkden
Manchester, England M28 5az
Telephone: 061-790-4591/2 Telex: 668666

ENGLAND (cont.)

LONDON OFFICE:
Digital Equipment Co. Ltd.
Bilton House, Uxbridge Road, Ealing, London W.5.
Telephone: 01-579-2781 Telex: 84327

FRANCE

PARIS OFFICE:
Equipement Digital S.A.R.L.
233 Rue de Charenton, Paris 12, France
Telephone: 344-76-07 TWX: 21339

BENELUX

THE HAGUE OFFICE:
(serving Belgium, Luxembourg, and The Netherlands)
Digital Equipment N.V.
Koninginnegracht 65, The Hague, Netherlands
Telephone: 635960 Telex: 32533

SWEDEN

STOCKHOLM OFFICE:
Digital Equipment Aktiebolag
Vretenvagen 2, S-171 54 Solna, Sweden
Telephone: 08 98 13 90 Telex: 170 50/Digital S
Cable: Digital Stockholm

SWITZERLAND

GENEVA OFFICE:
Digital Equipment Corporation International-Europe
81 Route De L'Aire
1227 Carouge / Geneva, Switzerland
Telephone: 42 79 50 Telex: 22 683

ITALY

MILAN OFFICE:
Digital Equipment S. p. A.
Corso Garibaldi, 49, 20121 Milano, Italy
Telephone: 872 748, 872 694, 872 394
Telex: 33615

AUSTRALIA

SYDNEY OFFICE:
Digital Equipment Australia Pty. Ltd.
75 Alexander Street, Crows Nest, N.S.W. 2065.
Australia
Telephone: 439-2566 Telex: AA20740
Cable: Digital, Sydney

MELBOURNE OFFICE:
Digital Equipment Australia Pty. Ltd.
60 Park Street, South Melbourne, Victoria, 3205
Telephone: 69-6142 Telex: AA80700

WESTERN AUSTRALIA OFFICE:
Digital Equipment Australia Pty. Ltd.
643 Murray Street
West Perth, Western Australia 6005
Telephone: 21-4993 Telex: AA92140

BRISBANE OFFICE:
Digital Equipment Australia Pty. Ltd.
139 Merivale Street, South Brisbane
Queensland, Australia 4101
Telephone: 44047 Telex: AA40616

JAPAN

TOKYO OFFICE:
Rikei Trading Co., Ltd. (sales only)
Kozato-Kaikan Bldg.
No. 18-14, Nishishimbashi 1-chome
Minato-Ku, Tokyo, Japan
Telephone: 5915246 Telex: 7814208

Digital Equipment Corporation International
(engineering and services)
Fukuyoshicho Building, No. 2-6, Roppongi 2-Chome,
Minato-Ku, Tokyo
Telephone (No): 585-3624 Telex (No): 0242-2650

unnecessary (be consistent with other offices)

Telex

answer back code; not part of number

AA is part of answer code only! not part of Telex number

unlabeled

102638145

841 is access code for Germany from USA *be consistent with other offices*

