

# HEWLETT-PACKARD JOURNAL

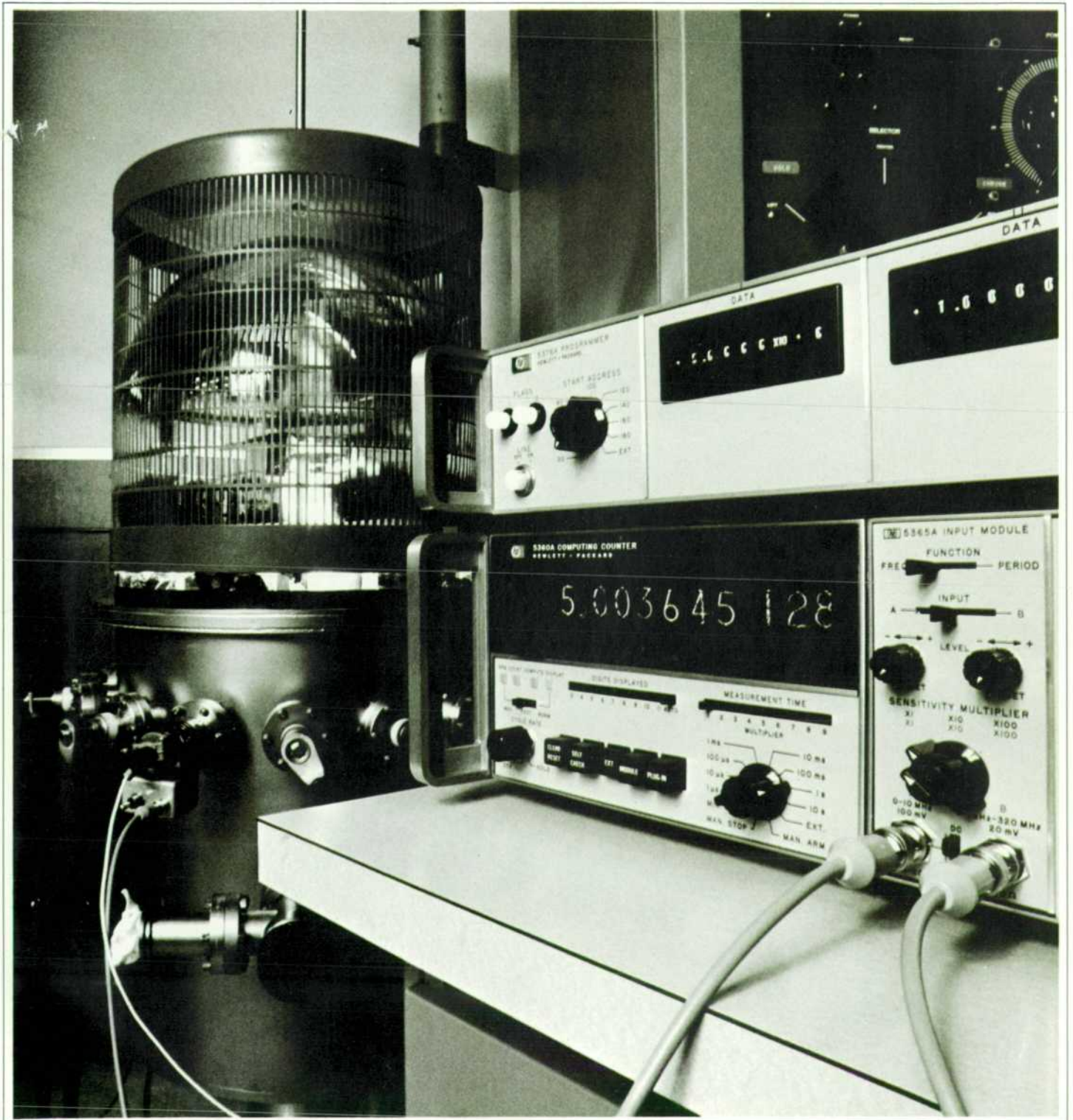

DECEMBER 1970



# Computing-Counter Measurement Systems

*Automated measurements and data processing don't necessarily require a computer. Systems based on the HP computing counter and a new programmer have computer capabilities but lower-than-computer costs.*

**By David Martin**

IF THE HISTORY OF THE ART AND SCIENCE OF MEASUREMENT could be viewed as a sequence of ages, the current one would have to be called the Age of Automation. Systems are everywhere, performing with varying degrees of automation a variety of functions that used to be drudgery for human beings.

The most automated systems have digital computers as system controllers. In these systems, automated measurements are only a beginning. The computer can be and usually is programmed to perform arithmetic operations to reduce the raw measured data to the most advantageous form for its ultimate use.

Computing-counter systems are a new type of low-cost computerized instrumentation system. These systems have no computer as such, but instead are built around the HP 5360A Computing Counter<sup>1</sup>, an instrument which is part computer and part digital measuring instrument. Like computerized systems, computing-counter systems have the ability to make measurements automatically and perform arithmetic operations on the measured data, all under program control. True, these systems don't have the 'horsepower' of a computerized system. They are, however, simple to operate, they have precision measurement capability, and because they contain no computer, their cost in a given application may be much less than a computerized system designed for the same application.

Fig. 1 is the basic block diagram of a computing-counter system. The arithmetic unit of the computing counter provides the mathematical functions add, subtract, multiply, and divide. The instrument part of the computing counter is called the measurement section.

Programmability is provided by a new instrument, Model 5376A Programmer, which also acts as an interface between the computing counter and other instruments or peripheral devices.\* The programmer has

outputs for time synchronization, delay generation, and integration with the outside world to make a practical, working, measurement system. Most programmer capabilities are plug-in options. Thus the system configuration can be tailored to fit exactly the requirements of the application. Capabilities not needed are not paid for, but can be added easily in the field if requirements change. The programmer is described in detail in the article on page 7.

\*The computing counter can also be programmed by its keyboard, Model 5375A (see Ref. 2). For systems use, however, Model 5376A Programmer offers several advantages: it is rack mountable, it retains its program when the power goes off, it has a larger program memory, and it has interface facilities.



**Cover:** Crystal plating is a typical process-control application for the 5360A Computing Counter and its new Programmer, Model 5376A (on top of the computing counter). See page 5 for a more complete description.

Other applications for the computing counter and programmer are in data reduction and statistical analysis.

## ***In this Issue:***

*Computing-Counter Measurement Systems, by David Martin* .....page 2

*Programmer Is Key to Computing-Counter Systems, by Eric M. Ingman* .....page 7

*Measuring Noise and Level On International Telephone Systems, by Jim Plumb and Jacques Holtzinger* .....page 13



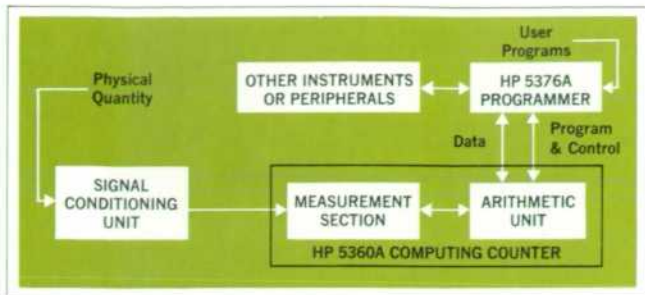

**Fig. 1.** Computing-counter systems, like computerized systems, can make measurements and arithmetically manipulate the data resulting from the measurements, all under program control. Applications are in data reduction, statistical analysis, process control.

### Measurement Capabilities

By itself, the computing counter measures frequencies between 0.01 Hz and 320 MHz directly, with 11-digit precision. It can also measure the time between two events to a resolution of 100 picoseconds, about the time it takes light to travel one inch. Its precision is of an order matched only by the most complex of systems, and is the result of making its arithmetic capability an inherent part of its measurement functions.

With an appropriate signal conditioning unit to convert the physical quantity being measured to a form compatible with the computing counter's measurement section, other kinds of measurements can also be made. Temperature, for example, can be measured with microdegree resolution. Phase, inductance, resistance, and other quantities can be measured by indirect techniques, using the arithmetic capability of the system.

Addition of other instruments to the system, using the

programmer as an interface device, greatly extends the measurement capability of the system. Fitted with its optional digital input/output facilities, the programmer can control many kinds of HP digital instruments and receive data from them. The digital I/O might be used, for example, to add a digital voltmeter to the system. Digital output is also useful for recording results using a digital printer or other peripheral device.

Another programmer option, a two-channel analog output, can be used to record data on X-Y plotters. Analog output can also serve as a feedback control signal in process-control applications.

### Programs

Programs are written in the machine language of the computing-counter system. This language is well documented and easy to learn. Programs are implemented by diode arrays or punched card, both of which act as read-only memories, retaining their programs when power is turned off or lost.

The maximum program memory is 200 steps long—short by computer standards. However, the machine language is quite efficient so the memory capacity is sufficient for most applications for which this type of system is suited.

Fig. 2 is a photograph of a typical system.

### Computing-Counter Systems

There are three principal categories of applications for computing-counter systems:

- data reduction
- statistical analysis
- process control.

Here are several examples.



**Fig. 2.** A new modular systems programmer, Model 5376A, is the cornerstone of computing-counter systems. It is programmed by plug-in diodes or by punched card. Details are in the article on page 7.



### Data Reduction

A good example of the data-reduction capability of computing-counter systems is the area of *nonlinear systems analysis*. Most transducers are to some extent nonlinear. By determining the transducer transfer function  $y=f(x)$ , measuring the transducer output  $x$ , and programming the computing-counter system to solve for  $f(x)$ , a direct readout of the transducer input can be obtained.

For a specific example, take the measurement of boron concentration. Boron concentration gives a measure of the rate of reaction of an atomic reactor. A transducer is available which produces an output frequency dependent upon the boron concentration. Fig. 3 shows its transfer function. Programmed to solve the equation of this function, the computing-counter system becomes a 'boronmeter,' displaying boron concentration in real time. The transfer function need not even be known. Given sample coordinates, a computer program is available that can calculate the transfer function that best fits the coordinates over any given range. Logarithmic, exponential, square-law and polynomial functions up to eighth order can be handled by this program.<sup>3</sup>

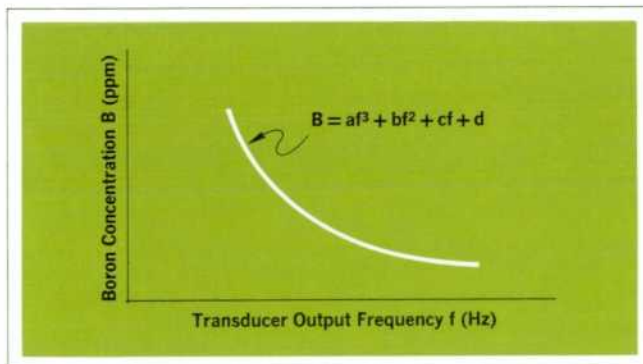

Fig. 3. Transducer transfer function relating boron concentration to transducer output frequency. Computing-counter system can solve this equation and display boron concentration directly, like a 'boronmeter.'

### Statistical Analysis

*Standard deviation* is a frequently used statistical quantity. Programming the computing-counter system to determine the standard deviation of a number of measurements is a simple matter. Probably more meaningful where frequency measurements are concerned, however, is the *Allan variance*.<sup>4</sup> This is a specially modified form of standard deviation which provides a direct measure of the fractional frequency deviation or short-term stability of a frequency source. The Allan variance is defined as

$$\sigma_{\Delta f/f}(2, \tau) = \frac{1}{f_0} \sqrt{\frac{1}{2N} \sum_{i=1}^N (f_{2i} - f_{2i-1})^2}$$

where  $\tau$  is the averaging time for each frequency sample  $f_i$ .

Fig. 4 illustrates the kind of results this measurement gives—a complete characterization of the frequency instabilities of the source in the time domain.

Equally simple to implement is a program to measure *FM deviation*. Average carrier frequency and peak deviation above and below the average can be measured. The flow diagram of this program is shown in Fig. 5. It consumes 79 steps of the 200 available.

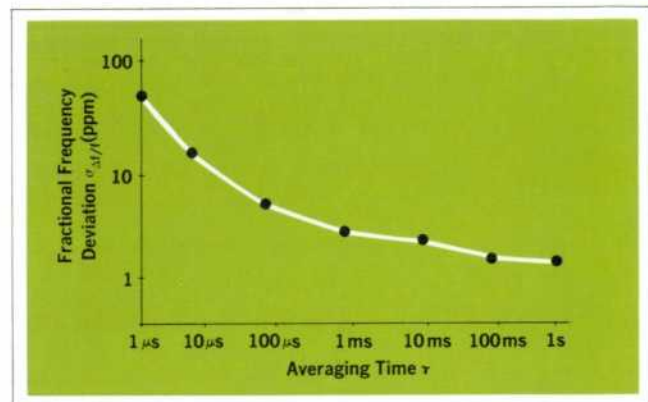

Fig. 4. Short-term stability of an oscillator. The computing-counter system can be programmed to make the frequency measurements and perform the computations needed to obtain a direct readout of  $\sigma_{\Delta f/f}$ .

The program consists of making a series of measurements  $f_i$  of the frequency-modulated signal and computing

$$f_{av} = \frac{1}{N} \sum_{i=1}^N f_i,$$

the average carrier frequency. The number of measurements  $N$  is determined by the setting of one of the front-panel thumbwheel switch assemblies of the programmer. Typically,  $N$  would be set at 1000. The program also compares each frequency  $f_i$  with maximum ( $f_{max}$ ) and minimum ( $f_{min}$ ) values stored in registers in the programmer. These registers are updated if  $f_i$  exceeds the previously stored value. After  $N$  measurements the quantities stored in these registers represent the maximum and minimum frequency excursions of the signal. The program automatically displays the average frequency and the peak deviation above and below the average. It typically takes, including the measurements, less than ten seconds.

Another example in the area of statistical analysis is the measurement of *integral nonlinearity*. This quantity gives a meaningful measure of the amount of nonlinearity in analog devices such as voltage-controlled and FM



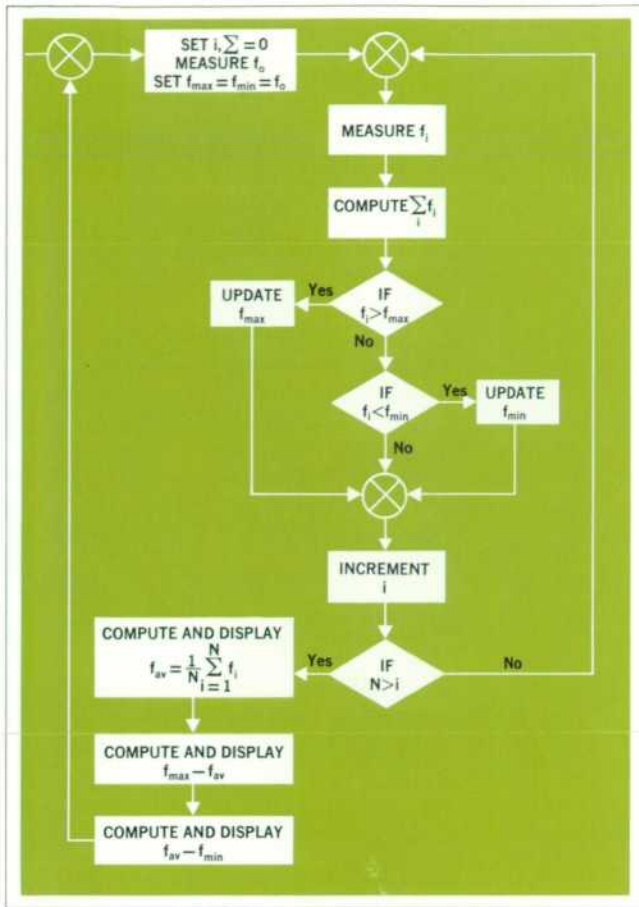

Fig. 5. Flow diagram of program for computing-counter system to arrive at average frequency and peak deviations of a frequency modulated signal.

oscillators, voltage-to-frequency converters, transducers, and so on. For a voltage-controlled oscillator, the integral nonlinearity is illustrated by Fig. 6.

The equipment setup to make such a measurement is shown in Fig. 7. The computing-counter system generates a voltage stimulus, which here is a staircase, under program control. At each voltage step the voltage  $X_i$  and the frequency  $Y_i$  are measured. From the voltage

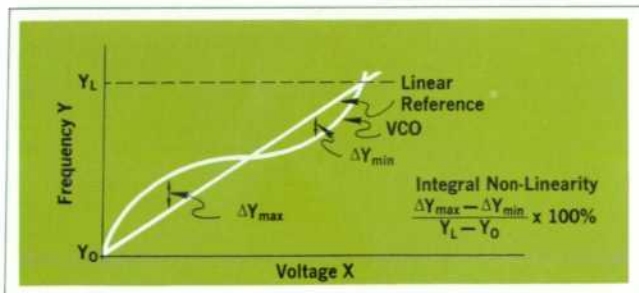

Fig. 6. Integral nonlinearity of a voltage-controlled oscillator.

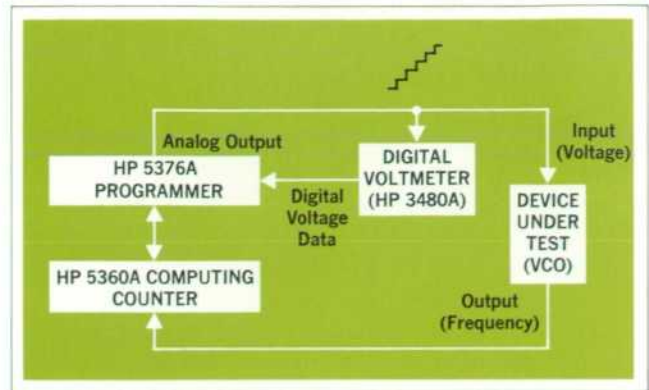

Fig. 7. Computing-counter system to measure integral nonlinearity.

measurement  $X_i$  and the equation of the reference line, the nominal frequency  $Y_{nom1}$  is computed. Then  $\Delta Y_i = Y_i - Y_{nom1}$  is calculated. The maximum  $\Delta Y_{max}$  and minimum  $\Delta Y_{min}$  of all the  $\Delta Y_i$  are retained. From these values, the integral nonlinearity is computed and displayed directly in percent.

The system can also be programmed, of course, to determine the reference line. Least-squares fit and average slope are two generally used criteria. A disadvantage of both these criteria is that all the  $\Delta Y_i$  have to be measured twice, once to determine the equation of the reference line, and second to measure the integral nonlinearity with respect to this reference. This can be avoided by specifying the reference as that line passing through the origin and intersecting the curve at the specified full scale value  $Y_L$ .

### Process Control

Its ability to output digital and analog data under program control makes the computing-counter system suitable for process-control applications. These outputs would normally be used as the feedback or control signals in such applications.

A typical application where the analog output is used is in crystal plating. In manufacturing crystal oscillators and filters the final adjustment in frequency is made by depositing gold onto the crystal. The heater which controls the gold deposition is in turn controlled by the analog output voltage. A typical setup is shown in Fig. 8.

The crystal output frequency is continually monitored by the computing-counter system. The control voltage generated is proportional to the difference between the actual frequency  $f_c$  and the desired final frequency  $f_o$ . In practice, to ensure that  $f_c$  does not overshoot  $f_o$ , the output voltage would be proportional to the logarithm of  $(f_c - f_o)$  as illustrated by Fig. 9.

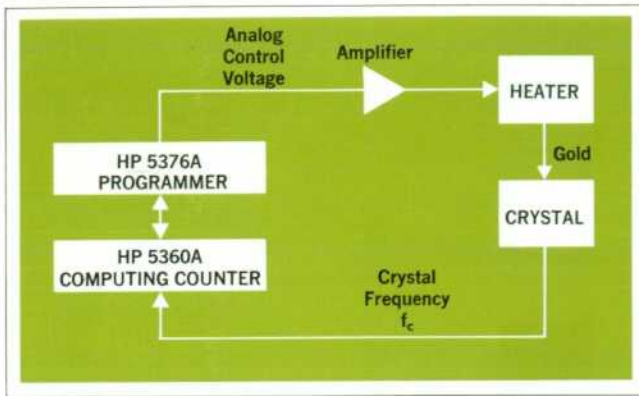

**Fig. 8.** Crystal plating system, with computing-counter system in feedback loop. Counter system controls gold deposition to tune crystal to proper frequency.

### Many More

These examples illustrate the problem-solving capabilities of the computing-counter system—solutions obtained by virtue of the system’s ability to measure and compute. The list of applications for which the computing-counter system is suited is by no means exhausted by these few examples, of course. 

### References

1. G. B. Gordon and G. A. Reeser, ‘Introducing the Computing Counter,’ Hewlett-Packard Journal, May 1969.
2. K. M. Ferguson, ‘The Computing Counter Gets Its Keyboard,’ Hewlett-Packard Journal, March 1970.
3. ‘Nonlinear Systems Analysis with the Computing Counter System,’ Hewlett-Packard Application Note 120-3.
4. D. W. Allan, ‘Statistics of Atomic Frequency Standards,’ IEEE Proceedings, Vol. 54, No. 2, February 1966.

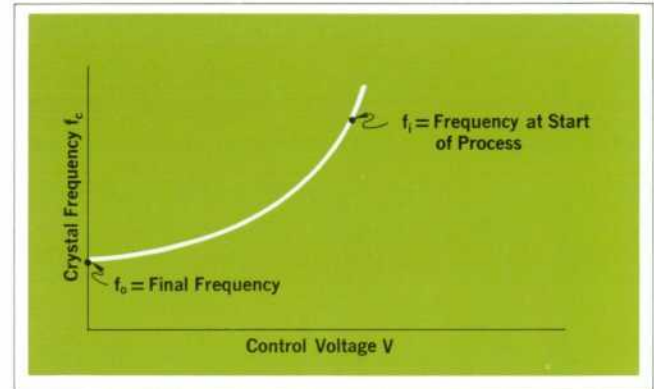

**Fig. 9.** Heater control voltage as a function of crystal frequency. Computing-counter system must measure crystal frequency and adjust heater voltage accordingly.

### Eric M. Ingman



Although they didn’t know each other in school, Eric Ingman and Dave Martin are both graduates of the University of Sydney, Australia. After receiving his electrical engineering degree, Eric went back to his native England for graduate training, then returned to Australia, and finally came to the United States, where he joined HP in 1964. In 1967, on a visit to the HP Sales organization in Australia, he met Dave Martin, who had joined HP the year before. Neither knew then that they would eventually find themselves at HP’s Santa Clara Division working on the same instrument, Eric as project leader for the 5376A Programmer and Dave as product manager for the Computing Counter System.

Before joining HP Eric designed communications equipment in Australia. His first HP projects were nuclear instruments, a multi-channel analyzer and several NIM instruments. Eric owns an airplane, a Mooney Mark 21 which he flies for pleasure, and he has a one-third share in a Cal 24 sailboat, which he has raced but

now sails mostly for fun.

Dave Martin holds two bachelor’s degrees, one in physics and mathematics (1961) and one in communications engineering (1963). Before joining HP he did research and development on television transmitters in Sydney. He joined the factory computing-counter marketing team in late 1967. A sports enthusiast, Dave alternates between participant and spectator, the former on the golf course and the latter mainly at football games.

### David Martin





# Programmer Is Key to Computing-Counter Systems

*This modular programmer provides programmability and interface facilities to go with the computing counter's arithmetic and precision measurement capabilities.*

By Eric M. Ingman

MANY MEASUREMENT SITUATIONS REQUIRE on-line reduction of digital data on a routine basis. In production testing, equipment is often operated by semi-skilled personnel. A computerized system can do on-line data reduction and can be automatic and easy to operate, but in many instances the computer would be dedicated to a straightforward series of arithmetic operations and much of the complexity and cost of a general-purpose computer would be wasted. For applications which fit this pattern, systems based upon the HP 5360A Computing Counter (see article, page 2) may be the answer.

The computing counter has both an arithmetic unit and a measurement section capable of making precise measurements of time interval and frequency. Frequency, of course, is a basic and universally measured parameter. Other parameters, too, such as voltage and temperature, can often be conveniently digitized by converting to frequency. As a result, most measurement systems include an electronic counter.

Equipped with its new Model 5376A Programmer, the computing counter has everything needed in a measurement system. The programmer provides

- means for programming the computing counter, either by plug-in diodes or by punched card
- as many as six data storage registers
- as many as three thumbwheel switch registers for manual data entry
- as many as two analog outputs for plotting or process control
- digital input and output for communication with other instruments and peripheral devices
- miscellaneous inputs and outputs for synchronization, control, and time-delay generation.

Most of these programmer capabilities come in the form of plug-in options. A user can optimize the price/performance ratio of his system by specifying only the programmer options he needs. All options can be installed using only a screwdriver, so a system can be updated or modified at any time without difficulty.

Fig. 1 shows the programmer with the computing counter and card reader, and Fig. 2 shows the programmer options and where they plug into the programmer.

## Digital Input and Output

Many electronic instruments have digital outputs and many have remote-control inputs. When the programmer is fitted with its optional digital input/output, such instruments can be integrated into the computing-counter system, making them, in effect, plug-ins for the computing counter. Digital output can also be used for recording data on a digital printer, tape recorder, or other peripheral device. There are two I/O connectors, so two instruments or peripherals can be included in the system at the same time. Each connector has its own independent control lines.

The digital I/O option transmits numbers in floating-point, parallel,  $+8421$  binary-coded-decimal format. It provides for eleven digits of data plus two digits for exponent size, sign of number, and sign of exponent. Other data codes can be accommodated by using special conversion programs or by special wiring of the input lines.

There are two modes of data transfer. In one mode the programmer reads the input lines when it receives a command from the instrument. If there are two instruments, commands must be received from both before



**Fig. 1.** New HP 5376A Programmer (center) is a programming and interface device for the HP 5360A Computing Counter. Together the two instruments are the nucleus of a class of low-cost programmable systems with built-in computer capability. Punched-card reader (top) provides optional programming method.

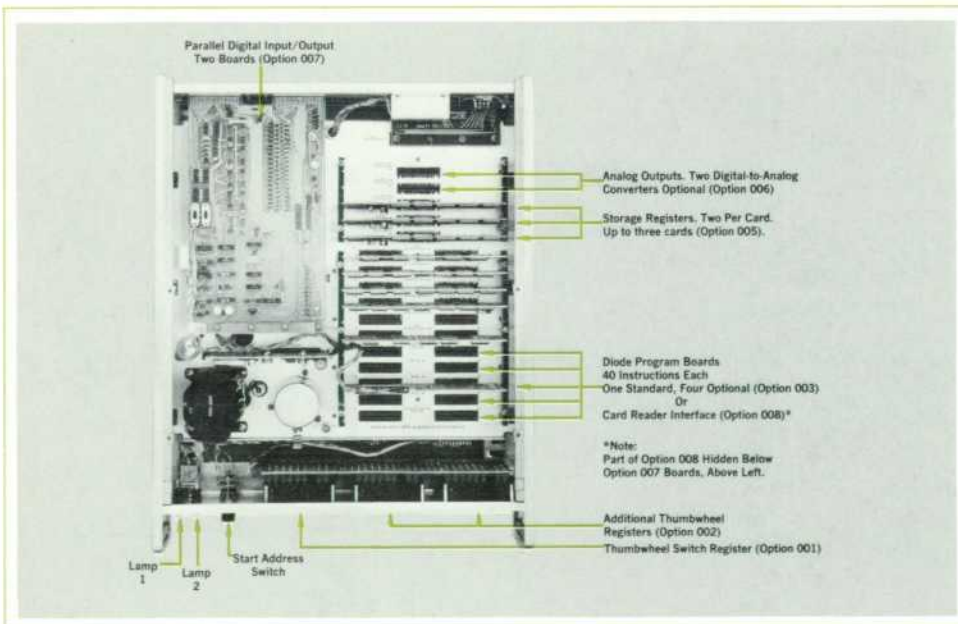

**Fig. 2.** Most programmer capabilities come as plug-in options, requiring only a screwdriver to install. Systems can be tailored to fit the requirements of a given application, and still be readily modified later.

data input occurs. Alternatively, the command from the instrument can be dispensed with.

To reduce loading and to improve noise immunity all data input lines have a high impedance and a long time constant. Logical '1' and '0' levels are defined by reference voltages and can be anywhere within a relatively wide range. If a data line is left open the programmer interprets it as a logical zero; this saves having to ground unused inputs.

### Analog Output

For driving X-Y recorders and plotters, or for pro-

viding stimulus voltages in a measurement system or feedback signals in process control, the programmer can have as many as two separate analog outputs. These outputs are derived from optional plug-in digital-to-analog converters. Each output has its own program code and can be addressed individually by the program.

Data enters the D-to-A converter in serial, floating-point, binary-coded-decimal format. The converter looks at the exponent and converts the number to fixed-point form. If the number exceeds the dynamic range of the converter the output is either full-scale voltage or zero volts, as appropriate.



Before conversion to analog form, the binary-coded-decimal numbers are first converted to binary in a BCD-to-binary converter. This converter drives the switches in a conventional 10-bit binary resistor ladder network which does the final conversion to a bipolar analog voltage. The final converter is a thin-film hybrid circuit containing the switches and thin-film resistor ladder network in one package.

### Manual Data Entry

Tolerances, limits, and other constants needed in programs can be entered by means of front-panel thumbwheel switch registers, another programmer option. There can be as many as three of these registers. They can enter positive or negative numbers in floating-point form, each number consisting of five digits plus an exponent from  $-9$  to  $+9$ .

### Extra Storage Registers

In the computing counter are three registers that are used for accumulating measured data and two registers that are available for storing data and intermediate results of programs. Complex programs may require more storage registers. The programmer can provide as many as six additional registers. All are optional and they come in pairs, two registers on a plug-in printed-circuit board.

### Lamps and External Control

On the front panel of the programmer are two lamps which are under program control. They are useful for such things as alerting operators or indicating whether a device has passed or failed a test. Rear-panel electrical outputs indicate whether the lamps are on or off. The lamps and outputs are standard, not optional.

Also standard is a rear-panel connector at which

several outputs are available. There are four lines which carry signals to control external devices. Sixteen different codes can be generated under program control and carried by these lines. Two other lines indicate whether the two front-panel lamps are on or off. Another output is a synchronization signal for the control of system timing.

Along with these outputs, several input lines are also available at the same connector. There are remote hold-off inputs useful in time-delay generation and in system timing, and remote inputs for selecting program starting addresses.

### Programming

Computing-counter systems are easy to program. Programming consists of listing the type and sequence of instructions that will cause the system to perform a given task, and then entering these instructions into the programmer using either plug-in diodes or a punched card.

Each instruction is expressed by a two-digit octal number, or OP-code. When diode programming is used, the OP-code corresponding to each instruction is 'hard-wired' into a small diode package by clipping leads off the package, as shown in Fig. 3. These diode packages are then plugged into program boards. The position of a package on the board determines when the corresponding instruction will be executed in the program (i.e., its address).

Each program board can hold 40 diode packages. One board is supplied with the programmer, and four more are optional. Thus the system can have a capacity of 200 program instructions. Some operations require more than one instruction, so programs will normally have

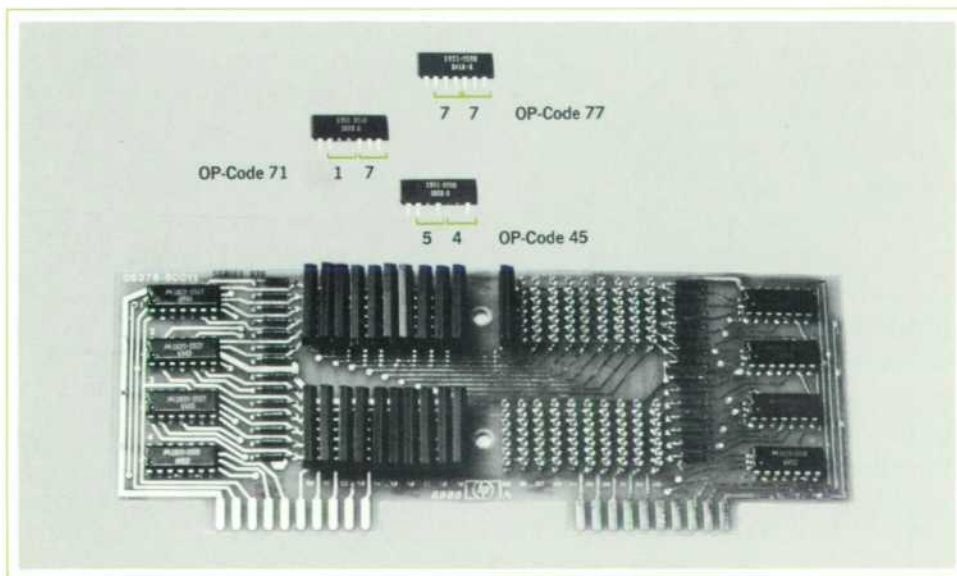

**Fig. 3.** When diode programming is used (rather than punched card), program instructions are coded by clipping leads off diode packages which are then plugged into program boards as shown. Programmer comes with one 40-instruction program board and can accommodate four more.



5376A PROGRAMMING FORM																			
ADDRESS	INSTRUCTION SYMBOL	CODE	WORKING STORAGE			INT	SOB	STORAGE REGISTERS											
			X	Y	Z			DATA 0	DATA 1	DATA 2	DATA 3	DATA 4	DATA 5						
0	CLR X	06	0																
1	INT X	61				$\Sigma + 0$													
2	INT X	63	0																
3	SQ S X	60				$\langle + 0$													
4	MOD B	41	$f_0$																
5	DATA X	71																	
6	0	20					$f_0$												
7	DATA XY	73																	
8	0	20	$f_0$																
9	DATA X	71																	
0	1	21					$f_0$												
1	MOD B	41	$f_i$			$\Sigma (i-1) f_{max} f_{min}$													
2	Z X	76				$f_i$													
3	Z XY	77	$f_i$			$f_i$													
4	INT XY	63	$\Sigma (i-1)$			$f_i$													
5	+	52	$\Sigma i f_i$																
6	INT X	61				$\Sigma i$													
7	DATA XY	73																	
8	1	21	$f_{max}$																
9	Z XY	77	$f_i$			$f_{max}$													
0	-	53	$f_{max} - f_i$																
1	IF X > 0	10																	
2	Go To	17																	
3	5	26																	
4	6	26																	
5	0	20																	
6	DATA XY	73																	
7	1	21	$f_{min}$																
8	Z XY	77	$f_i$			$f_{min}$													
9	-	53	$f_{min} - f_i$																
0	IF X > 0	10																	
1	Go To	17																	
2	2	22																	
3	7	27																	
4	0	20																	
5	21	21	-1																
6	SQ X	62	$-(i-1)$																
7	+	52	-1																
8	SQ X	60																	
9	SQ XY	62																	

Fig. 4. Program for the FM deviation application described on page 4.

fewer than 200 distinct operations.

Within the 200 instructions there can be as many as ten independent programs. The program to be run is determined by the front-panel START ADDRESS switch, or by remote control.

Punched-card programming requires the optional card reader. Each card can hold 160 instructions and as many as eight independent programs.

The two methods of programming—diode and card—have compatible codes. A program can be checked and easily altered using the card reader and then permanently entered using the plug-in diodes. Punched-card programming is also useful when many different programs are to be run at different times, as might be the case in a laboratory environment.

Once programs have been entered they can be checked in one of two ways. First, to check that the diodes have been plugged in correctly or the card punched in the right spots, the program can be stepped through manually and each program code and its corresponding address displayed. Second, to troubleshoot the program, the contents of the x register can be displayed after each instruction as the program runs.

### Fifty-six Instructions

The programmer has a repertoire of 56 OP-codes, or instructions. These can be divided into five groups. In the table on page 11, x, y, z, sqs, pi, int, and data ( ) refer to registers (including the thumbwheel switch registers) or their contents.

### Program Example

Fig. 4 is the program for the FM deviation measurement described on page 4. It contains 79 instructions. The programmer options required in this system are

- one thumbwheel switch assembly
- one program board (two boards total)
- one storage register card.

### Acknowledgments

Thanks are due David Martin and Gilbert Reeser for their help in initial product definition and later marketing support. Charles Trimble and Keith Ferguson offered constructive criticism and support. The tidy, easily serviceable product design was by William Anson. Carl Spalding contributed computer test programs. Many others helped in various ways and their vital support is much appreciated.



## Instruction Repertoire, HP 5376A Programmer

### A. ARITHMETIC

Instruction	OP-Code	Description
+	52	$x \leftarrow y + x, y \leftarrow x$ ; old y lost
-	53	$x \leftarrow y - x, y \leftarrow x$ ; old y lost
X	57	$x \leftarrow x * y, y \leftarrow x; z \leftarrow y$ ; old z lost
÷	56	$x \leftarrow y / x, y \leftarrow x, z \leftarrow ?$ ; old y, z lost
2x	64	$x \leftarrow 2x$ ; old x lost
10x	51	$x \leftarrow 10x$ ; old x lost
1/ x	54	$x \leftarrow 1/ x , y \leftarrow x$ ; old y lost
$\sqrt{x}$	45	$x \leftarrow \sqrt{x}, sqs \leftarrow x$ ; old x, y, z lost
x/10	74	$x \leftarrow x/10$ ; old x lost

### B. REGISTER TRANSFER

Instruction	OP-Code	Description
y $\leftrightarrow$ x	65	Exchange the contents of the x and y registers.
z $\leftrightarrow$ x	75	Exchange the contents of the x and z registers.
pi $\leftrightarrow$ x	70	Exchange the contents of the plug-in register and the x register.
int $\leftrightarrow$ x	61	Exchange the contents of the internal and x register.
sqs $\leftrightarrow$ x	60	Exchange the contents of the sqs and x register.
data ( ) $\leftrightarrow$ x	71	Exchange the contents of the designated data register (0-8, a, b, c, d) and the x register. The OP-code following 71 identifies one of the optional storage registers (0-5), thumbwheel switch registers (6, 7, 8), digital-to-analog converters (a, b), or serial-to-parallel converters (c, d).
$x_i$ $y_i$	67	$y \leftarrow x$ ; old y lost.
z $x_i$ $y_i$	77	$y \leftarrow x, x \leftarrow z$ ; old y lost.
sqs $x_i$ $y_i$	62	$y \leftarrow x, x \leftarrow sqs$ ; old y lost.
data ( ) $x_i$ $y_i$	73	$y \leftarrow x, x \leftarrow \text{data ( )}$ ; old y lost.
int $x_i$ $y_i$	63	$y \leftarrow x, x \leftarrow \text{int}$ ; old y lost.
pi $x_i$ $y_i$	72	$y \leftarrow x, x \leftarrow \text{pi}$ ; old y lost.

### C. READOUT AND GENERAL CONTROL

Instruction	OP-Code	Description
DISPLAY x	50	x displayed; no register changed.
LAMP 1	04	Turn on front-panel light #1.
LAMP 2	14	Turn on front-panel light #2.
LAMP OFF	05	Turn out the lights on the front panel. (This is automatically preferred when the reset button on the counter is pushed.)
EXT ( )	12	Output ( ) on four lines to control ext. device. Negative logic. ( ) can be 0-9, a, b, c, d, e, f. Output is stored. A strobe line is provided for clocking this 4-line code into an external register. A holdoff line is provided (negative) to hold this step until an external result is accomplished.
CONTINUE	07	Dummy statement.
END	00	Missing instruction signifies end of program, causes automatic return to starting address on front panel selector switch.
SELF CHECK	46	Runs counter in self check mode. Calls self check sub-program in mainframe.
CALIBRATE	47	Runs counter in calibrate mode. Calls calibrate sub-program in mainframe. Successive calls are required to display calibration.

### D. LOOPING AND BRANCHING

Instruction	OP-Code	Description
If x < 0	10	If x register < 0 (> 0), then do next statement, otherwise skip to the following instruction.
If x > 0	11	skip to the following instruction.
GO SUB ( ) ( ) ( )	13	Go to the subroutine starting at address ( ) ( ) ( ). The least significant digit of the address is given first. Used in conjunction with return.
RETURN	15	Jump back to the statement following go sub ( ) ( ) ( ).
GO TO ( ) ( ) ( )	17	Jump to ( ) ( ) ( ). Least significant digit first.
CLEAR x	66	Clear the x register.
CLEAR xyz	76	Clear the x, y, z registers.
CLEAR data	16	Clear all optional registers.

### E. MEASUREMENT AND CONSTANTS

Instruction	OP-Code	Description
PLUG IN	43	Carry out the measurement program located in the plug-in, module A, module B respectively.
MOD A	42	
MOD B	41	
Numbers		
0	20	Constants are entered least significant digit first. There can be up to 11 digits. The decimal point is assumed to occur between the first and second most significant digit. This floating point constant is followed by a two-digit code giving the sign of the number, the sign of the exponent, and the exponent, which can range from 0 to 31.
1	21	
2	22	
3	23	
4	24	
5	25	
6	26	
7	27	
8	30	
9	31	
a	32	
b	33	
c	34	
d	35	
e	36	
f	37	



## SPECIFICATIONS

### HP Model 5376A Systems Programmer

Specifications apply only when the 5376A Systems Programmer is used with the 5360A Computing Counter.

**DESCRIPTION:** The 5376A Systems Programmer is a programming device for the 5360A Computing Counter. When programmed, the 5376A enables the 5360A to solve equations, where measurements made by the 5360A and/or a peripheral digital instrument are the variables, and display the solution in real time.

#### PROGRAM MEMORY

**TYPE:** Read-only memory by diodes (see Option 003) or an IBM card (see Option 008).

**CAPACITY:** Diodes—to 200 program steps maximum in 40 step increments. The basic 5376A is provided with 40 program steps. IBM Card—160 Program Steps.

**STARTING ADDRESS:** The starting address of a program is defined by setting of the START ADDRESS switch on the 5376A front panel. At completion, the program automatically returns to the starting address and recycles through it again. The START ADDRESS switch allows up to 10 independent programs, each 20 steps long, to be installed (8 independent programs with IBM card).

With the START ADDRESS at EXT, this switch is remotely programmable via a 4 line digital code applied to the rear panel AUXILIARY INPUT-OUTPUT connector.

**FLAGS 1 & 2:** Can be turned on or off under program control. Parallel electrical outputs are provided from the AUXILIARY INPUT-OUTPUT connector.

**STORAGE MEMORY:** 13 bit read-write IC shift registers. See Option 005 for details.

**OPERATING TEMPERATURE:** 0°C to +50°C.

**POWER:** 115 V or 230 V  $\pm 10\%$ , 50 to 400 Hz, 70 W with all options included.

**DIMENSIONS:** 16 $\frac{1}{4}$  in wide, 3 $\frac{1}{2}$  in high, 16 $\frac{1}{2}$  in deep.

**WEIGHT:** Net 21 lbs, shipping 25 lbs, 10 oz.

**PRICE: \$1,350.00** (includes 1 Opt. 003, 40 step program board).

#### OPTION 001: INITIAL THUMBWHEEL SWITCH ASSEMBLY

Used for manual entry of numerical data.

**NUMBER CAPACITY:**  $\pm 9.9999 \times 10^{+9}$ .

**FORMAT:** Number is fixed point with 5 digit maximum mantissa, mantissa sign, exponent and exponent sign.

**PRICE: \$275.00**

#### OPTION 002: ADDITIONAL THUMBWHEEL SWITCH ASSEMBLIES

Same specifications as Option 001. Up to two Option 002 assemblies can be installed.

**PRICE: \$150.00 each.**

#### OPTION 003: PROGRAM BOARD

Consists of a program board and 44 diode package arrays. Each diode package array gives one program step. A program board has a maximum capacity of 40 program steps.

Up to four Option 003 program boards can be installed. Including the program board provided with the instrument, this gives a total capacity of 200 steps.

**PRICE: \$350.00 each.**

#### OPTION 004: PROGRAM DIODES

Provides 22 additional program diode arrays.

**PRICE: \$65.00**

#### OPTION 005: REGISTER CARD

One Option 005 register card contains two volatile read-write storage registers for the storage of numerical constants or intermediate results of a program.

**STORAGE REGISTER CAPACITY:** Any number in the range  $\pm 1 \times 10^{-31}$  to  $\pm 9.999\ 999\ 999 \times 10^{+31}$ . Up to three Option 005 register cards can be installed.

**PRICE: \$200.00 each.**

#### OPTION 006: DIGITAL-ANALOG CONVERTER

**DESCRIPTION:** The digital-analog converters provide an analog output of digital information stored in the 5360A-5376A System.

**OUTPUT VOLTAGE RANGE:** +9.99 volts to -9.99 volts.

**RESOLUTION:** 0.01 volt.

**ACCURACY:** 0.2% of full scale at 25°C.

**SLEW RATE:** <20 ms/volt.

**LOAD CURRENT:** 2 mA max.

**TEMPERATURE DRIFT:** 1 mV/°C.

Up to two digital-analog converters can be installed.

**PRICE: \$500.00 each.**

#### OPTION 007: PARALLEL DIGITAL INPUT-OUTPUT

Allows digital data stored in the 5360A-5376A to be output or external digital data to be put into the 5360A-5376A System.

##### DIGITAL OUTPUT

**TYPE:** Parallel 8421 bcd, 1 state positive. '0' state +0.3 V typical, '1' state +5 V typical.

**FORMAT:** Eleven digit mantissa maximum, mantissa sign, exponent, exponent sign. Any number from  $\pm 1 \times 10^{-31}$  to  $\pm 9.999\ 999\ 999 \times 10^{+31}$  can be output. Print commands, hold-offs, reference levels are compatible with the HP 5050B Digital Recorder.

##### DIGITAL INPUT

**TYPE:** Same as Digital Output. '1' state must differ from '0' state by at least 4.5 V but no more than 50 V.

**FORMAT:** Same as Digital Output.

Dual capability is provided, i.e. dual digital output and dual digital input can be obtained. In addition, both inputs and outputs can be connected simultaneously.

**PRICE: \$600.00.**

#### OPTION 008: CARD READER

**DESCRIPTION:** Consists of an AMP card-reader and interfacing circuitry to the 5376A Systems Programmer. An alternative programming method to Option 003. Uses a standard IBM card (7 $\frac{1}{8}$  in x 3 $\frac{1}{8}$  in).

Cards may be prepared by using the WRIGHT MANUAL CARD PUNCH. In addition, many varieties of motor driven card punches can be found throughout the industry (for example IBM 29 Card Punch).

**PRICE: \$2,090.00**

#### MANUFACTURING DIVISION: SANTA CLARA DIVISION

5301 Stevens Creek Boulevard  
Santa Clara, California 95050



# Measuring Noise And Level On International Telephone Systems

By Jim Plumb and Jacques Holtzinger

IN COUNTRIES WHERE ECONOMIC DEVELOPMENT IS A MAJOR OBJECTIVE, the need for exchange of information and ideas is increasing at an extraordinary rate. This exchange requires good quality telecommunication channels.

Measurements made to assure quality transmission of telephone and broadcast equipment include measuring attenuation or gain versus frequency, and measuring nonlinear distortion. Another important measurement is noise power or voltage in the telephone circuits.

## Noise Sources in a Transmission System

In telephone and high quality audio or video transmission systems, besides the traditional amplifier noise, thermal noise and induced ac from power lines or ripple, some other important disturbing sources of noise are:

- Crosstalk produced by inductive or capacitive coupling between lines in parallel or at junctions, which can be intelligible, unintelligible or either (babble) when from a various number of sources.
- Clicks and scratching noise generated by atmospheric disturbances, autos, neon lights, defective soldered joints or connections.
- Acoustic noise directly coupled into the telephone sets.

These many sources of noise affect transmission quality. Evaluating these for the purpose of improving quality requires an objective measurement with a voltmeter. Two new instruments have been designed specifically for measurements on telephone systems using CCITT (Consultative Committee on International Telephone and Telegraph) standards. (Systems operating on CCITT standards are outside the U.S. and Canada. Telephone systems in the U.S. and Canada operate on Bell System standards.)

These new instruments are the HP Model 3556A Psophometer, and the HP Model 236A-H10 Telephone Test Oscillator, Fig. 1. Used together, they are a complete transmission measuring set.

## Weighting Filter Curves and Standards

The disturbance which noise causes to telephone users depends upon various factors which include the sensitivity of the ear as a function of frequency. Since noise may be intermittent or continuous, appropriate integration time of the noise voltage must be defined. A voltmeter based upon these considerations will make meaningful, comparable measurements. This voltmeter, the Psophometer, is an apparatus for the objective measurement of circuit noise (in Greek, *psophos* means noise).

The major difference between the Bell System and CCITT standards are in the frequency response curves or weighting curves used to measure commercial telephone and broadcast or program transmission lines, and in the impedances. Noise interferes with speech transmission in different ways. Telephone transmission quality also varies from one facility to another. It is necessary, then, to use a weighting response curve representing not only the average frequency response of the handset, telephone line and human ear, but also an average of these combined different responses.

Tests by the Joint Subcommittee on Development and Research of the Edison Electric Institute and the Bell Telephone System determined the appropriate weighting curves. These tests have been approved by the CCITT, but different weights were given to various frequencies. Thus the weighting curves have slightly different configurations (Fig. 2).

With these curves, equalizing networks may be constructed so that each component frequency of the voice



**Fig. 1.** The HP Model 236A Opt H10 Test Oscillator (left) and the Model 3556A Psophometer are designed specifically for making measurements on telephone systems using CCITT standards (most systems outside the United States and Canada).

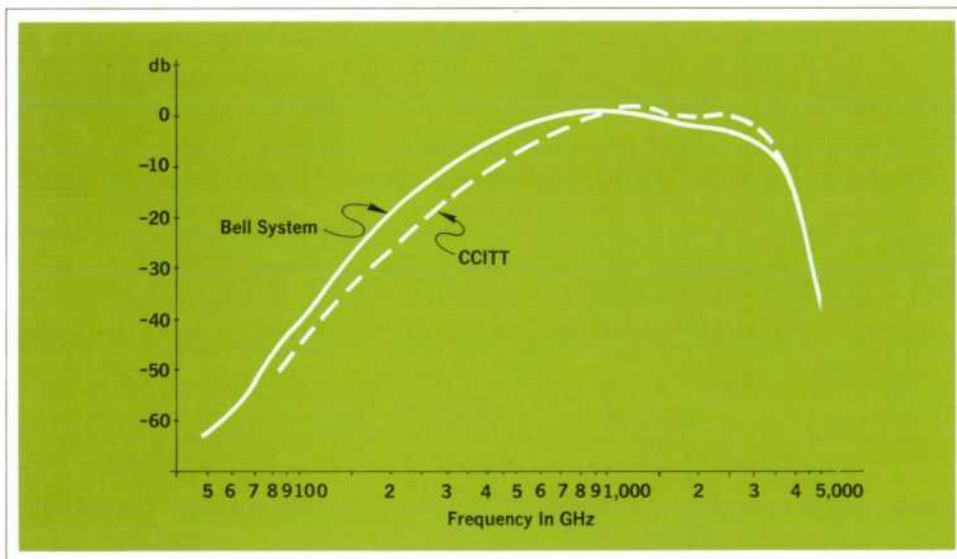

**Fig. 2.** Characteristic curves of filter networks used for measurements of telephone circuits.

spectrum is attenuated in the same way it appears to be attenuated by the average ear with the listening test apparatus.

By using these equalizers with a suitable amplifier, rectifier and dc meter, it is possible to make an electrical measurement of the interfering effect of any frequency or combination of frequencies. The HP Model 3556A Psophometer incorporates these equalizers or weighting filters and the necessary circuitry to perform such noise measurements. There is a telephone filter and a program filter. The telephone filter, used for measurements on telephone lines, simulates the average frequency response of the receiver handset and of the human ear for low

volume sounds. The program filter is used for measurements on quality program lines for radio broadcasts, studio-to-transmitter links and TV audio channels.

To determine the amount of noise or tone superimposed on a conversation, the Psophometer is calibrated so that a 800 Hz tone at 0 dBm in a 600 ohm resistance (1 mW) will produce a meter reading of 0.775 volt psophometrically weighted.

#### Noise and Level Measurements

While external noise disturbs the intelligibility of communications, it is not the only factor. Level variations in transmission also affect intelligibility. Consequently,



assuring high quality transmission also requires level measurements. The HP Model 3556A Psophometer makes both noise and level measurements.

For noise measurements, the HP Model 3556A is a sensitive and accurate voltmeter/powermeter. In addition to the two CCITT noise weighting filters there are two low pass filters; 3 kHz and 15 kHz bandwidth may be selected for measuring noise on telephone lines and broadcast channels.

The four filters are built into the instrument and selected by a lever switch, eliminating the need for plug-in filters.

Pushbuttons set up circuits to measure either metallic noise (symmetrical noise voltage or normal mode noise voltage) and noise to ground (asymmetrical noise voltage or common mode noise voltage).

Unlike conventional rms-responding thermocouple meters, the Model 3556A has a fast response to input changes (200 ms response to impulse noise) to simulate the response of the human ear. If noise fluctuations make reading difficult, the reading can be smoothed by slowing response time to 500 ms with a front panel switch.

For level measurements, the HP Model 3556A is a broadband voltmeter/powermeter. The frequency range covered is 30 Hz to 3 MHz at 75  $\Omega$  impedance for carrier level measurements. Bandwidths of 1 kHz to 150 kHz at 600  $\Omega$  and 1 kHz to 600 kHz at 150  $\Omega$  are offered. Flat response from 20 Hz to 20 kHz is also available at 600  $\Omega$  for audio frequency measurements.

To complement the Model 3556A for level measurements (attenuations, gain and crosstalk levels), the HP 236A-H10 Telephone Test Oscillator is a reference source with the same flexibility.

#### **HP 3556A Psophometer**

The Model 3556A consists basically of an input impedance selection network, a range attenuator tied to a balanced input transformer and input amplifier, selectable weighting filters and an rms detector. Standard Siemens input-output connectors are on the front panel as well as banana type binding posts. The 75  $\Omega$  symmetrical input is of BNC type.

The input impedance network provides the proper impedance across the input terminals to terminate or bridge the circuit under test. Inputs are terminated or non-terminated for 150 and 600 ohm symmetrical, and for 75 ohm asymmetrical. Non-terminated impedance is greater than 15 k $\Omega$  symmetrical and 100 k $\Omega$  asymmetrical, assuring that the instrument will not disturb working telephone circuits.

A symmetrical transformer is used in the input to achieve the required frequency response and balance between each input terminal and ground. As common mode voltages on a telephone line are sometimes high in noise-to-ground measurements, a circuit is switched into the input to provide 40 dB attenuation. In this case, the side of the line being measured is loaded with 100 k $\Omega$ , a load that is negligible in these circumstances.

In the hold mode a built-in holding coil simulates an off-hook condition and permits holding the line while noise or level measurements are being made.

The meter always reads dBm directly for 600  $\Omega$  and 150  $\Omega$  impedances. The meter also reads in volts for 600  $\Omega$  and 75  $\Omega$  impedances. Outputs for handsets and a dc recorder are also included.

The instrument weighs 6,8 kg, and is housed in a splashproof case for use in the field as well as in the office. It can be operated from mains power between 90 V and 250 V ac, 48 Hz to 440 Hz without voltage switching, or from rechargeable batteries (a dry battery is an option).

#### **HP 236A-H10 Test Oscillator**

The Model 236A-H10 Telephone Test Oscillator consists of an oscillator-amplifier, attenuator, power supply, meter circuit and a selective output circuit. The oscillator uses a modified Wien bridge network to generate a stable, low-distortion, sine-wave signal. A peak detector replaces the classic light bulb, providing a degenerative feedback voltage to the oscillator circuit to stabilize the output amplitude.

A three-step precision attenuator is calibrated to supply +10 to -30 dBm in 0.1 dBm steps into the selected output impedances. The output is coupled through transformers to provide a high degree of balance between each output terminal to ground. The 600 ohm output is coupled through a low frequency transformer (50 Hz to 20 kHz) and the 150 ohm and 75 ohm output through a high-frequency transformer (5 kHz to 560 kHz).

The reason for providing two output frequency ranges is because of different frequency range applications for the associated output impedances. The use of two transformers provides much flatter frequency response than one wideband transformer.

The instrument weighs 6,1 kg and is housed in the same splashproof case as the Psophometer. It can be operated from mains power 115 or 230 volts ac, or from dry batteries.

#### **Acknowledgments**

The advice and assistance of Pendell Pittman, Jim Plumb and Don Wick are gratefully acknowledged. 



## SPECIFICATIONS

### HP Model 3556A Psophometer

#### VOICE FREQUENCY LEVEL MEASUREMENTS (Flat input <20 kHz functions)

VOLTAGE RANGE: 0.1 mV to 30 V full scale, 12 ranges, in a 1, 3, 10 sequence.  
 dBm RANGE: -78 dBm to +32 dBm full scale, 12 ranges.  
 FREQUENCY RANGE: 20 Hz to 20 kHz.  
 LEVEL ACCURACY  
 100 Hz to 5 kHz:  $\pm 0.2$  dB  
 20 Hz to 20 kHz:  $\pm 0.5$  dB.

#### NOISE MEASUREMENTS (Filtered input <20 kHz functions)

VOLTAGE RANGE: 0.1 mV to 30 V full scale, 12 ranges, in a 1, 3, 10 sequence.  
 dBm RANGE: -78 dBm to +32 dBm full scale, 12 ranges.  
 WEIGHTING FILTERS:  
 TELEPHONE and PROGRAM weighting curves meet joint requirements of CCITT Psophometric Recommendation P53.  
 3 kHz LOW-PASS FILTER  
 15 kHz LOW-PASS FILTER.

#### CARRIER FREQUENCY LEVEL MEASUREMENTS (Flat input >1 kHz functions)

VOLTAGE RANGE: 3 mV to 3 V full scale, 7 ranges, in a 1, 3, 10 sequence.  
 dBm RANGE: -48 dBm to +12 dBm full scale, 7 ranges.  
 FREQUENCY RANGE: 30 Hz to 3 MHz.  
 LEVEL ACCURACY  
 600  $\Omega$  symmetrical  
 1 kHz to 150 kHz:  $\pm 0.5$  dB  
 10 kHz to 100 kHz:  $\pm 0.2$  dB.  
 150  $\Omega$  symmetrical  
 1 kHz to 600 kHz:  $\pm 0.5$  dB  
 10 kHz to 300 kHz:  $\pm 0.2$  dB.  
 75  $\Omega$  asymmetrical  
 100 Hz to 600 kHz:  $\pm 0.2$  dB  
 30 Hz to 1 MHz:  $\pm 0.5$  dB  
 1 MHz to 3 MHz:  $\pm 0.5$  dB  $\pm 10\%$  of meter reading.

#### GENERAL

METER READING: Linear dBm scale with 12 dBm range and logarithmic voltage scales with 1, 3, 10 sequence, indicate rms value of input signal. dBm scale is valid on 600  $\Omega$  and 150  $\Omega$  impedances, voltage scales are valid on 600  $\Omega$  and 75  $\Omega$  impedances.

#### METER RESPONSE

200 ms: Response time to indicate a reading from -10 dBm to 0 dBm.  
 500 ms: Response time to indicate a reading from -10 dBm to 0 dBm.

#### MAX INPUT VOLTAGE

a to b: 150 V peak  
 a or b to ground: 500 V peak.

#### POWER REQUIREMENTS

HP Model 3556A Standard: 4 rechargeable batteries (25 V total) or power line from 90 V ac to 250 V ac (without switch), 48 Hz to 440 Hz, <10 VA during battery charge.

#### HP 3556A Option 001

Internal battery: Single NEDA 202 45 V 'B' battery furnished.  
 Any battery meeting NEDA 202-specifications such as EVEREADY 482 or BURGESS M30 may be used.  
 Battery life: 180 hrs @ 4 hrs per day.

External battery: -24 V to -48 V office battery, <15 mA.

AC: 115 or 230 V (switch), 48 Hz to 440 Hz, <10 VA.

DIMENSIONS: 197 mm wide, 299 mm high, 207 mm deep (7 $\frac{3}{4}$  in x 11 $\frac{3}{4}$  in x 8 $\frac{1}{8}$  in).

WEIGHT: Net 6.8 kg (15 lb), shipping 7.5 kg (17 lb).

PRICE: HP 3556A (ac line and rechargeable battery) \$800.00. HP 3556A Option 001 (ac line internal dry battery and external supply) \$775.00. (Operating instructions printed in the protective cover in English supplied. Also available at no charge in German, Opt. 002; Italian, Opt. 003; French, Opt. 004; Spanish, Opt. 005; Portuguese, Opt. 006; Dutch, Opt. 007; and Finnish, Opt. 008.)

#### MODEL 236A OPT H10 TELEPHONE TEST OSCILLATOR

The HP 236A Opt. H10 Telephone Test Oscillator used in conjunction with the 3556A Psophometer makes a complete transmission test set for accurate, convenient voice and carrier measurements. The 236A Opt. H10 supplies precise test tones from -31 dBm to +10 dBm in 0.1 dBm steps over a frequency range of 50 Hz to 560 kHz. The test oscillator incorporates the same rugged, portable design, output jack flexibility and dial-through and hold features as the 3556A. Output is fully symmetrical and floating with a choice of 150  $\Omega$  or 600  $\Omega$  selectable output impedance. An output impedance of 75  $\Omega$  asymmetrical is also supplied.

PRICE: HP 236A Opt. H10, \$650.00.

(Operating instructions printed in the protective cover in English supplied. Also available at no charge in German, Opt. 002; Italian, Opt. 003; French, Opt. 004; and Spanish, Opt. 005.)

MANUFACTURING DIVISION: LOVELAND DIVISION  
 LOVELAND, COLORADO 80537

#### Jim Plumb



Jim earned his BSEE degree, with honors, from the Florida Institute of Technology. After graduation he joined the HP Loveland Division as customer service engineer, and later was an applications engineer. He was project leader on the 3556A project. Presently Jim supervises HP Loveland's special handling department.

Jim enjoys a variety of outdoor hobbies, including hiking and climbing in the local mountains, as well as skiing and motorcycling.

mountains, as well as skiing and motorcycling.

#### Jacques Holtzinger



Jacques is a native of Versailles, France. He joined the Hewlett-Packard field engineering office in Paris in 1964 as a support engineer. He became a field engineer in 1966, then came to the Loveland, Colorado Division in 1969, where he was a member of the design team on the Model 3556A. He is presently product manager on the Model 3556A.

Living in Colorado especially appeals to Jacques, with skiing, fishing and horseback riding ranking high among his favorite activities.

## HEWLETT-PACKARD JOURNAL DECEMBER 1970 Volume 22 • Number 4

TECHNICAL INFORMATION FROM THE LABORATORIES OF HEWLETT-PACKARD COMPANY 1501 PAGE MILL ROAD, PALO ALTO, CALIFORNIA 94304 U.S.A.  
 Hewlett-Packard S.A. 1217 Meyrin - Geneva, Switzerland • Yokagawa-Hewlett-Packard Ltd., Shibuya-Ku, Tokyo 151 Japan

Editor: R. H. Snyder Editorial Board: R. P. Dolan, L. D. Shergalis Art Director: Arvid A. Danielson Assistant: Maridel Jordan