

# HEWLETT-PACKARD JOURNAL



MARCH 1970

# The Computing Counter Gets Its Keyboard

*The computing counter with its keyboard has the computing ability and operating convenience of a programmable desk calculator, plus the ability to make measurements and process the measured data in real time.*

By Keith M. Ferguson

THANKS TO ITS INTERPOLATION TECHNIQUE AND ITS BUILT-IN ARITHMETIC PROCESSOR, the HP 5360A Computing Counter\* that made its debut last year is almost certainly the fastest and most accurate electronic counter yet developed. Now it is even more. Design of the Model 5375A Keyboard has been completed, giving computing-counter users a means of gaining easy access to the counter's arithmetic processor. With the keyboard, the counter can be programmed to do things that are, to say the least, unusual for a counter.

Together with its keyboard and its plug-ins the counter is a small measurement/computer system that is both powerful and easy to operate. The system works very much like a programmable desk calculator with the ability to learn and repeat programs. However, three keys on the new keyboard aren't found on any calculator. These keys call for measurements on input signals. The following examples indicate the kinds of programs that have already been written using the counter's ability to mix measurements and computations.

- Phase calculations
- Frequency deviation calculations
- Units conversion, e.g.
  - frequency to RPM
  - time interval to distance
  - time interval to velocity
- Frequency conversion calculations
- Statistical analysis, e.g.
  - running average
  - mean, variance, standard deviation
  - maximum and minimum values
  - percent of measurements exceeding a specified value

- Limit testing

- Formula solving, e.g.

crystal impedance from frequency measurements. This is only a partial list, of course. Potential applications of the counter and keyboard include all the uses of a counter and a desk calculator, plus numerous others.

## Keyboard Fundamentals

In contrast to conventional counters, the computing counter makes all its measurements under program control. When the counter is being used alone, measurements



### *In this Issue:*

- The Computing Counter Gets Its Keyboard*, by Keith M. Ferguson . . . . . **page 2**
- Protecting Hospitalized Patients from Electrical Hazards*, by William F. Craven . . . . . **page 11**
- Calculator Processes Multichannel Analyzer Data*, by Norman D. Marschke . . . . . **page 18**

\* Hewlett-Packard Journal, May 1969.





A Programmable Measurement/Computing System: Model 5360A Computing Counter with Model 5379A Time Interval Plug-in and the new Model 5375 A Keyboard



**Fig. 1.** Model 5375A Keyboard is an external programmer for Model 5360A Computing Counter. Programs can be executed manually, or learned and executed repetitively. The Keyboard can make comparisons, do program looping and branching, and insert constants into programs.

are controlled by read-only programs wired into the mainframe and the plug-ins. However, when the EXT button on the front panel is pressed, the counter is placed under the control of external programming devices, such as the keyboard.

The keyboard is basically a device for presenting programs or sequences of instructions to the computing counter, and for entering numerical data. The keyboard has memory for data and programs, and has the ability to make comparisons, and perform program looping and branching.

There are two data storage registers—the b and c registers—in the keyboard, and another storage register—the a register—in the counter mainframe. Also in the mainframe are three working registers—the x, y, and z registers—which are used for arithmetic operations and for measurements. Each of the storage and working registers can hold a single eleven-digit number in floating-

point form, including sign and exponent. The exponent is a power of ten used as a scale factor; it can be any integer between  $-31$  and  $+31$ . Thus the stored number can range from  $1 \times 10^{-31}$  to  $9.999\ 999\ 999\ 9 \times 10^{31}$ . The counter displays numbers in the range  $1 \times 10^{-15}$  to  $999.999\ 999\ 99 \times 10^{12}$ , but the registers have a much greater capacity so they won't overflow when squares or square roots are called for.

There are several modes of keyboard operation. In the MANUAL mode the keys perform the indicated functions, with the results of each operation being displayed on the counter. The LEARN mode is used to teach the keyboard a program, a program which will later be run automatically in the RUN mode. The STEP mode is useful for checking a learned program.

Programs learned by the keyboard are stored in two program memories, designated MAIN and SUB. Each program memory can hold up to sixteen program steps.



## The Keys

Fig. 1 is a photograph of the new keyboard. The keys are arranged in groups according to their functions.

The keys in the rightmost group are the digit entry keys. They are used for manually loading a constant into the x register. The constant may contain a decimal point and a scale factor. To be consistent with the display, scale factors are entered in standard engineering units: femto, pico, nano, micro, milli, kilo, Mega, Giga, and Tera. Numbers may be either positive or negative.

When a constant is used in a program, it is first entered into the x register, using the digit entry keys, and it is then transferred to a data storage register. During execution of a program, the constant can be read out of the data register as often as needed.

The keys in this right-hand group are the only keys not directly learnable into a program.

The keys in the second group from the right are the arithmetic function keys. The keys  $+$ ,  $-$ ,  $\times$ , and  $\div$  calculate  $y+x$ ,  $y-x$ ,  $y \cdot x$ , and  $y/x$ , respectively, with the result being left in the x register. In all cases the old value of x moves into y. The  $\times$  operation replaces z with the old value of y, and  $\div$  loses the old value of both y and z. The  $\sqrt{x}$  key replaces x with  $\sqrt{x}$ , and loses the old values of y and z.

The keys  $\downarrow$  and  $\uparrow$  are used to bring the constants 1 and N into a program. N is the number set on the REPEAT LOOP switch (see Fig. 1). The usefulness of this feature will become apparent in the section on programming.

It is the  $\text{MODULE A}$ ,  $\text{MODULE B}$ , and  $\text{PLUG}$  keys that represent the most unusual feature of the keyboard—the ability to incorporate measured quantities in real-time calculations. The  $\text{MODULE A}$  and  $\text{MODULE B}$  keys call for a measurement through either channel A or channel B of the computing counter's input module.\* The type of measurement (period or frequency) is determined by the setting of the module's FUNCTION switch. Similarly,  $\text{PLUG}$  calls for a measurement through the plug-in compartment. The type of measurement depends on the particular plug-in that is in use. With existing plug-ins this could be either a time interval measurement or a heterodyned frequency measurement. As future plug-ins are introduced, it will be possible to make different kinds of measurements. Combined with the very high accuracy and speed of the computing counter, this ability to make measurements and incorporate

\* The input module is similar to the front end of a normal counter. It has two input channels, channel A for 0.01 Hz to 10 MHz and channel B for 1 kHz to 320 MHz. Keyboard selection of channel A or channel B can be overridden by the module front-panel controls. For modules with serial prefixes 848 and 904, the two MODULE keys do the same thing and the channel must be selected using the module controls.

them into mathematical calculations represents a significant advance in the art of measurement.

The remaining keys in the second group are self-explanatory.

The keys in the second group from the left cause interchanges of numbers among the various storage and working registers. The contents of the x register can be interchanged with that of any other register. The contents of the three storage registers and the z register can be nondestructively read into x, and x can be copied into y.

The keys in the last group, the group on the left, are for program control and comparison. The two IF keys compare the contents of the x register and the indicated data register (a or b). The outcome of the comparison is signaled by lights on the keyboard and by signals accessible at an auxiliary connector. (The output signals are useful for go/no-go production testing, among other things. See Fig. 5.) When an IF instruction is used in a program, the step following it will be skipped unless the condition is fulfilled, allowing for program branching dependent on measured or calculated values. When an IF instruction is executed in a program, the contents of a, b, and x are not affected, but the contents of the y register are replaced by  $a-x$  or  $b-x$ . An example of the use of the IF instruction can be found in Fig. 9.

The  $\text{STOP}$  instruction is a 'do nothing' program step. Its primary use is following an IF instruction, when no branching is desired.

The  $\text{PAUSE}$  instruction causes execution of the program to stop when the PAUSE HALT switch is on. The keyboard may then be used manually to enter constants or perform calculations. Following a pause, execution can be resumed from that point in the program.  $\text{PAUSE}$  can also be used to provide an optional display, dependent on the setting of the PAUSE DISPLAY switch.

## Memory Organization

The new keyboard's program memory is organized for maximum flexibility with a limited number of instructions. The result is a distinctly unusual memory organization. There are two memories, MAIN and SUB, of sixteen program steps each. (See Fig. 2.)

From any point in the MAIN program, control can be transferred—using the  $\text{1 PER PROG}$  key—to the beginning of the SUB program memory. The same  $\text{1 PER PROG}$  operation in the SUB program is used to resume the MAIN program, starting with the step after the XFER instruction in the MAIN program.

In many programs there is a need to repeat a group of instructions a specified number of times. For example,



the average or standard deviation of N measurements may be desired. The REPEAT key provides this capability.

Used in the MAIN program REPEAT causes program control to return to the beginning of the MAIN program. A REPEAT in the SUB program memory works in conjunction with the REPEAT LOOP switch (see Fig. 1). The first N-1 times that the REPEAT is encountered, control returns to the beginning of the SUB program memory. On the N<sup>th</sup> encounter, the REPEAT is ignored, and control continues through the remainder of the SUB program. Thus a group of instructions can be 'looped through' N times and the result used in subsequent calculations.

Whenever the program reaches the end of either the MAIN or the SUB program memories, execution continues from the beginning of the MAIN program. Entry of the first instruction of a new program automatically clears the memory by entering STOP STEP in every program step. Thus if only part of the memory is used for a program, the necessary STOP STEP steps to return to the beginning are automatically there. No END instructions are used.

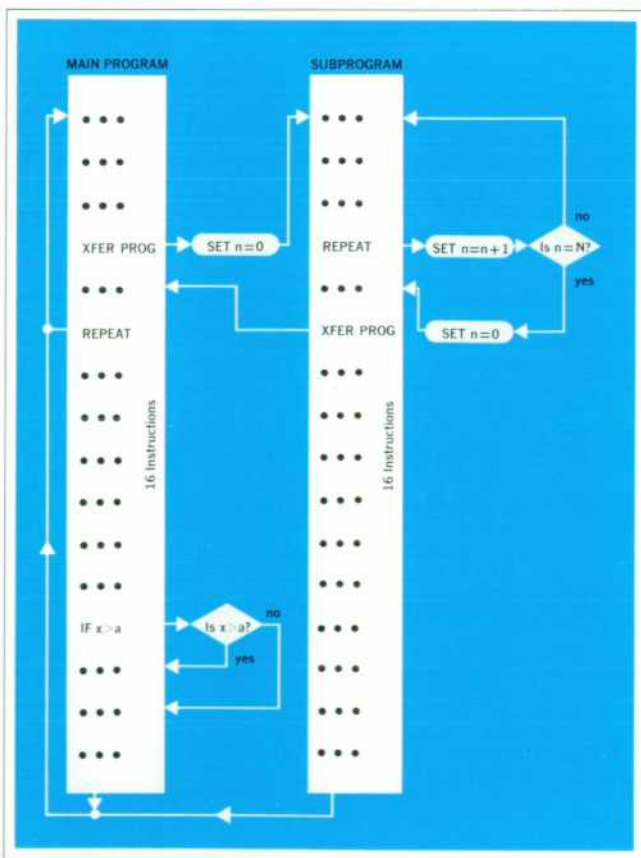

Fig. 2. Model 5375A Keyboard has two memories of sixteen program steps each. The XFER PROG key transfers control from one to the other. The IF keys are for program branching and the REPEAT key is for looping.

## Types of Programs

Most 5375A Keyboard programs can be placed in one of three categories.

**Linear:** The simplest type of program is the linear program. These programs contain no looping or branching. They may contain up to 32 steps, one of which must be a X FOR PROG. If the program contains sixteen or fewer steps, it can be placed entirely in one program memory and the X FOR PROG is not needed; this leaves the other memory available for a second program. Typical linear programs are phase calculations (Fig. 3) and units conversion (Fig. 4).

**Branching:** Branching programs are used when the calculations or manipulations to be performed depend on the outcome of some measurement. In this type of program, there is first some initial action, usually involving a measurement. One or more tests are then performed, either using the measurement directly as a parameter or using some value calculated from the measurement. The IF instructions are used to implement the tests, and the outcome determines whether control stays in the MAIN program or transfers to the SUB program. In either event, once the MAIN or SUB program is completed, control returns to the beginning of the MAIN program. The limit test program (Fig. 5) is an example of a branching program.

### PHASE PROGRAM

DESCRIPTION: Measures the phase shift between two signals of the same frequency. The two signals are applied to the Model 5379A Time Interval Plug-in, and one of the signals is also applied to the counter's input module, which is set for a period measurement. The measured quantities are  $\Delta t$ , the time difference between the signals, and P, the signals' period.

PROGRAM:

<b>MODULE A</b>	measures the period P
<b>a</b> → <b>x</b>	stores P in the a register
<b>PLUGIN</b>	measures the time difference $\Delta t$
<b>a</b> → <b>x</b> → <b>y</b>	recalls P
<b>÷</b>	divides $\Delta t$ by P
<b>b</b> → <b>x</b> → <b>y</b>	recalls 360
<b>×</b>	multiplies $\Delta t/P$ by 360
<b>DISPLAY x</b>	displays phase in degrees

OPERATION: The constant 360 is initially stored in the b register.

Fig. 3

### UNITS CONVERSION PROGRAM

DESCRIPTION: Converts cycles per second to revolutions per minute. A transducer on the rotating shaft produces one pulse per revolution, and the counter measures the frequency of the pulse train.

PROGRAM:

**MODULE A**      *measures frequency*  
 $\overline{a \quad x \quad y}$       *recalls 60*  
 X      *multiplies frequency by 60*  
**DISPLAY x**      *displays RPM*

OPERATION: The constant 60 is initially stored in a.

Fig. 4

### LIMIT TEST PROGRAM

DESCRIPTION: Measured values are compared against an upper limit and a lower limit. If value is within limits, zero is displayed. If out of limits, the difference between the measured value and the exceeded limit is displayed, with a minus sign indicating that the lower limit was the one exceeded. The program can either stop or continue following an out-of-limit condition, at the user's option.

PROGRAM:

<b>MAIN</b>	<b>SUB</b>
<b>MODULE A</b>	<b>CLEAR x</b>
<b>IF x &gt; A</b>	$y \curvearrowright x$
<b>XFER PROG</b>	-
<b>IF x &lt; b</b>	<b>PAUSE</b>
<b>XFER PROG</b>	
<b>CLEAR xyz</b>	
<b>DISPLAY x</b>	

OPERATION: Enter the upper limit in a, and the lower limit in b. Set PAUSE DISPLAY = ON. The PAUSE HALT switch determines whether an out-of-limit measurement causes a program stop.

Fig. 5

**Looping:** The looping program is used in many statistical calculations. It consists of three principal parts. The *initialization* section clears registers in preparation for the actual looping. This section is located in the MAIN program memory, and ends with a  instruction. The *loop* itself, located in the SUB program memory, is under the control of the REPEAT LOOP switch. This switch can be set at 1, 10, 100, 1000, or 10,000. After the loop has been executed the selected number of times, execution continues through the SUB program memory, which will

generally contain a *finalizing* section, ending with a display of the results. If additional storage is needed for these final calculations a  instruction will return control to the MAIN program, making available any space not used by the initialization section.

Note that the setting of the REPEAT LOOP switch, determining the number of times the loop is to be performed, may be changed after the program is learned. (While a program is being learned the switch is treated as if set to N=1, regardless of where it is actually set.) It is often of interest to see the effect of varying the num-

### SIMPLE AVERAGE PROGRAM

DESCRIPTION: Finds the average of N measurements.

PROGRAM:

<b>MAIN</b>	<b>SUB</b>
<b>CLEAR x</b>	$\overline{a \quad x \quad y}$
<b>XFER PROG</b>	<b>MODULE A</b>
	+
	<b>REPEAT</b>
	$\overline{N \quad x \quad y}$
	÷
	<b>DISPLAY x</b>

OPERATION: Set N on the REPEAT LOOP switch.

Fig. 6

ber of samples included in a calculation. The current setting of the REPEAT LOOP switch can be read into the x register using the  instruction, and can be used in the calculations. An example of a looping program for finding a simple average is shown in Fig. 6.

These three types of programs illustrate many of the techniques used in programming the keyboard. There are, of course, numerous variations on these basic types. For example, a program may first branch, and then one of the branches may contain a loop. The fractional frequency deviation program of Fig. 7 is an example of looping followed by branching.

The program in Fig. 8 illustrates another possibility, that of multiple subroutine calls. Here a group of instructions in the SUB program memory is to be executed at more than one point in the program. Instead of repeating these instructions each time they are needed, they are simply placed in the SUB program, from which they are called by the MAIN program each time they are needed.



## FRACTIONAL FREQUENCY STANDARD DEVIATIONS



DESCRIPTION: Solves the following equation:

$$\left(\frac{\Delta f}{f}\right)_{rms} = \frac{1}{f_0} \left( \frac{1}{2N} \sum_{i=1}^N (f_{2i} - f_{2i-1})^2 \right)^{1/2}$$



The resulting number is useful as a measure of the stability of a frequency source.

PROGRAM:

### MAIN

CLEAR x  
  
 XFER PROG  
 N x y  
 N x y  
 +  
 b x y  
  
 ÷  
 √x  
 c x y  
 ÷  
 DISPLAY x

### SUB

MODULE A  
  
 MODULE A  
 a x y  
 -  
 x y  
 ×  
 b x y  
 +  
  
 REPEAT  
 CLEAR x  
 IF x < b  
 XFER PROG  
 DISPLAY x

OPERATION: Load  $f_0$  into c initially. Set Non REPEAT LOOP switch.

REFERENCE: HP Application Note 116, 'Precision Frequency Measurements.'

Fig. 7

This is possible because the calling location is automatically remembered by the keyboard, and the  instruction in the SUB program causes a return to the following location. Transfers to the SUB program always enter it at the beginning, and the transfer sets the loop counter to zero.

It is useful to note that a program memory is cleared only when the first instruction of a new program is entered into that particular memory. Thus it is possible to change the MAIN program, for example, without re-entering the SUB program.

### Theory of Operation

A simplified block diagram of the keyboard is shown in Fig. 10. For normal instructions, that is, for those executed in the mainframe of the computing counter (+,

## Q OF A FILTER\*

DESCRIPTION: The filter is driven by a swept frequency source. Using an oscilloscope which has a delaying sweep (e.g., the HP 180A with 1821A Time Base), a trigger signal is generated for driving the EXT TRIG input on the rear of the computing counter. This trigger can be set at either the low-frequency or the high-frequency 3-dB point on the filter skirt. The counter measures the frequency at these points. Since a swept frequency source is being used, the counter measurement time must be kept short compared to the sweep rate; averaging is used to remove noise on the input signal. An average of N readings is taken at the low-frequency point. The trigger is then set to the high-frequency point and an average of N readings is again taken. The difference is then taken to determine  $\Delta f$ , and the average of the low and high points is used as an approximation to  $f_0$ .

The Q is then calculated as  $\frac{f_0}{\Delta f}$ .

PROGRAM:

### MAIN

CLEAR x  
 XFER PROG  
 CLEAR x  
 XFER PROG  
  
 a x y  
 b x y  
 -  
  
 +  
 c x y  
 ÷  
 PAUSE  
 a x y  
 ÷  
 PAUSE

### SUB

  
 MODULE A  
 c x y  
 +  
 REPEAT  
 N x y  
 ÷  
 PAUSE  
  
  
 1 x y  
 ÷  
 1 x y  
 +  
 XFER PROG

OPERATION: Set N on REPEAT LOOP switch. Set both PAUSE DISPLAY and PAUSE HALT to ON. Trigger counter at low-frequency 3-dB point, and start program. The average of N measurements will be displayed, and the program will stop. Change the trigger to the high frequency 3-dB point, and start program; the average reading will again be displayed. Start program again, and  $f_0 = \frac{f_2 + f_1}{2}$  will be displayed. Starting program once more will display the Q of the filter.

\*Program based on an idea of Lyle Jevons.

Fig. 8



## MAX-MIN PROGRAM

**DESCRIPTION:** Finds the maximum and minimum of  $N + 1$  measurements, and displays the difference.

**USES:** Used to determine the range of a measured variable. If the measurement time is short compared to the period of the modulating signal, this could be a measurement of FM deviation or residual FM.

**PROGRAM:**

### MAIN

#### MODULE A



XFER PROG

### SUB

#### MODULE A

IF  $x > a$



IF  $x < b$



REPEAT



PAUSE

**OPERATION:** Set  $N$  on the REPEAT LOOPswitch. Set PAUSE DISPLAY = ON. If PAUSE HALT is OFF, program will run continuously, displaying Range = Max - Min. If PAUSE HALT is ON, program will stop after each display; the maximum measurement can be read out with  $\overline{a} \ x \ \overline{y}$ , and the minimum with  $\overline{b} \ x \ \overline{y}$ .

Fig. 9

-,  $\times$ ,  $\div$ , etc.), the keyboard presents a 5-bit operation code to the counter. A 'start' signal is generated, and the keyboard then waits for a completion signal to be returned by the counter.

In the MANUAL mode, the instruction code is read from the diode encoder into the program buffer, under the control of the timing generator, which then generates the 'start' signal. Upon completion of the operation the display generator places the display instruction code in the program buffer, and the counter is again started, displaying the results of the previous operation.

The STEP mode is identical to MANUAL mode except that when the START switch is pushed codes are read from the program memory instead of from the diode encoder.

In the LEARN mode, codes are read from the diode matrix, as in the MANUAL mode, but they are stored in the program memory as well as executed. In the LEARN mode, the REPEAT instruction is not executed, and the IF instructions do not cause skipping of the next instruction, even though the condition is not met. This simplifies the entry of programs.

### Other External Programmers

The computing counter can also be programmed by other external devices in place of its keyboard. For example, there is the Model 10538A Fixed Program Shell. This diode-programmed device can hold fixed programs of up to 18 steps. It is programmed by clipping leads off

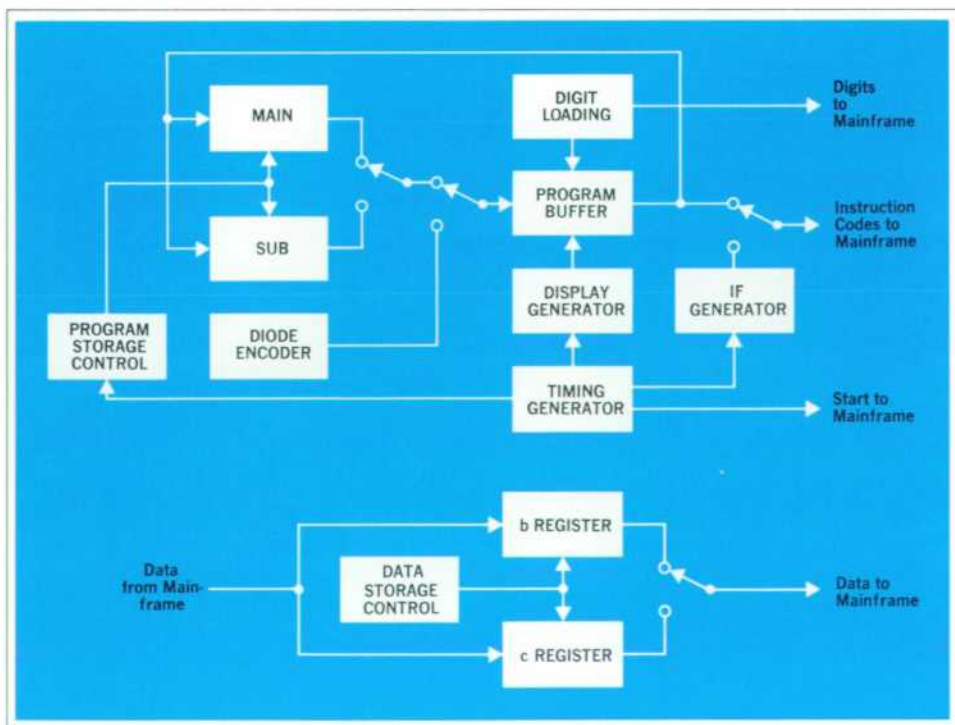

Fig. 10. Keyboard presents five-bit operation codes to counter mainframe to control measurements, arithmetic operations, and displays. Two storage registers are in the keyboard; a third storage register and three working registers are in the counter mainframe.

multiple-diode packages, and inserting the resulting packages into the shell. While no provision exists for internal looping, branching, or digit entry, and the program shell is more limited in its data storage capability than the keyboard, it does provide a convenient, low-cost method of executing relatively simple programs. The phase program (Fig. 3) is an example of a program that can be modified to operate from the program shell (the constant, 360, must be synthesized using the arithmetic operations available in the computing counter).

It is also possible to interface the counter with a digital computer, in such a way that the computer can program the counter and transfer data in and out.

#### Acknowledgments

Many people contributed to the design of the 5375A Keyboard. Charles Hill, as section manager, helped develop the basic concepts of the keyboard. Keith Leslie and Larry Brendlin were responsible for the product design. Roger Lee and Bernard Barke assisted in the design of the housing. While designing the computing section of the 5360A Computing Counter, France Rodé, Gary Gordon, and Roger Smith developed and tested a number of the circuit concepts. Carl Spalding has given

valuable assistance in developing testing procedures, and Richard Buchanan assisted in the construction of earlier versions. Throughout the development program these people and many others contributed many suggestions that influenced the evolution of the final product. ■

#### Keith M. Ferguson



Keith Ferguson can never be accused of being out of tune with our mobile society. A native of Texas who later moved to California, he crossed the country to earn his B.S., M.S., and E.E. degrees in electrical engineering at Massachusetts Institute of Technology, then retraced his steps to join HP in 1965. He worked on the 5360A Computing Counter until 1969, then took over the leadership of the 5375A

Keyboard project.

Keith is a member of IEEE and the American Association for the Advancement of Science, and of two honor societies, Eta Kappa Nu and Tau Beta Pi. He enjoys camping, backpacking, and skiing, and as a result is vitally interested in conservation, an interest he expresses through membership in the Sierra Club.

## Correction to "Flying Clock' Comparisons Extended to East Europe, Africa and Australia"

Hewlett-Packard Journal  
Volume 19, Number 4 (December, 1967)

By Leonard S. Cutler

The relativistic effects on clocks in motion were discussed in the December, 1967 issue of the Hewlett-Packard Journal. Professor Joseph C. Hafele of Washington University pointed out correctly that we had neglected the effect of the rotation of the earth. Since the velocity due to this rotation is 1038 mi/hr at the equator on the surface, the effect is not negligible.

The correct expression is (for constant heights, velocities and latitudes):

$$\frac{T_1 - T_2}{T_1} \approx \frac{(g_1 h_1 - g_2 h_2)}{c^2} - \frac{(2\omega R (v_{1e} \cos \theta_1 - v_{2e} \cos \theta_2) + v_1^2 - v_2^2)}{2c^2}$$

where  $T_1$  and  $T_2$  are the indicated elapsed times of two flying clocks,  $h_1$  and  $h_2$  are the heights of the clocks above the surface of the earth,  $v_1$  and  $v_2$  are their velocities with respect to the surface of the earth,  $v_{1e}$  and  $v_{2e}$  are the eastward components of the velocities,  $\theta_1$  and  $\theta_2$  are the latitude angles,  $c$  is the speed of light,  $\omega$  is the angular velocity of the earth,  $R$  is the radius of the earth, and  $g_1$  and  $g_2$  are the values of the acceleration due to gravity at the surface for each latitude.

If the two clocks fly at the same height and speed in opposite directions at the equator with clock 1 going east, we have

$$\frac{T_1 - T_2}{T_1} \approx -\frac{2\omega R v}{c^2}$$

This amounts to  $-4.8 \times 10^{-12}$  or .4  $\mu$ sec in one day if the planes could fly continuously at 1038 mi/hr (the velocity of the earth's surface).

The correct expression for  $\frac{T_{fc} - T_0}{T_0}$  where  $T_{fc}$  is the indicated elapsed time of a flying clock and  $T_0$  is the indicated elapsed time of the ground clock (corrected to sea level), is

$$\frac{T_{fc} - T_0}{T_0} \approx \frac{1}{T_0} \int_0^{T_0} \left[ \frac{g(t) h(t)}{c^2} - \frac{2\omega R v_e(t) \cos \theta(t) + v(t)^2}{2c^2} \right] dt$$

where  $g(t)$ ,  $h(t)$ ,  $v_e(t)$ ,  $v(t)$ , and  $\theta(t)$  are the instantaneous values for the flying clock. For a clock flying eastward at the equator at 35,000 ft and 650 miles per hour, this amounts to  $-.81 \times 10^{-12}$ . If the clock had been flying westward, the result would be  $+2.19 \times 10^{-12}$ .



# Protecting Hospitalized Patients from Electrical Hazards

By William F. Craven

*Electrodes internal to the body give rise to safety problems far more complex than generally supposed, requiring changed thinking about the design and use of medical electronics equipment. Electronic engineers, who will readily understand the needed preventive measures described here, can help explain these important concepts to hospital planners, architects, administrators, and medical personnel.*





EVEN BEFORE RALPH NADER ALERTED THE GENERAL PUBLIC to the danger, medical practitioners were concerned about the growing possibility that hospital patients connected to monitoring equipment might be electrocuted. The equipment itself is basically harmless but, because it makes conductive contact to the patient, it can be the key link in a life-threatening current path.

Although it is difficult to determine how many patients actually are electrocuted, because death of the very ill is often attributed to other causes, accidental deaths from electrocution have been reported in the literature since 1960.<sup>1</sup> Some of these accidents are caused by faulty electronic equipment, but more often they are caused by misapplication of equipment. I would like to discuss here the subtle ways electrocution can occur, and what can be done to reduce the likelihood of such catastrophes.

### Electric Shock

There has been concern about shock hazard ever since electric power came into general use in the late nineteenth century. Many investigations were conducted to establish safety standards, most of them concerned with gross effects—like pain, muscle stimulation, and tissue destruction from burning—caused by electrical current traveling through the intact skin from limb to limb. The results of these investigations are summarized in Table I,

**TABLE I**

**Effects of 60 Hz electric current on the average human through his trunk (one-second contact)**

.001A	Threshold of perception.
.016A	"Let-go" current. Sustained muscular contraction.
.05A	Pain. Possible fainting, exhaustion, mechanical injury. Heart and respiratory functions continue.
.1 to 3A	Ventricular fibrillation. Respiratory center intact.
>6A	Sustained myocardial contraction followed by normal heart rhythm. Temporary respiratory paralysis. Burns if current density is high.

which shows the effects that various current levels have on human beings.<sup>2</sup>

Although it varies widely from person to person, the threshold of perception is about 1 mA. At this level, a faint tingling sensation is felt. At a current level of 5 mA, many sensory nerves are stimulated and the sensation becomes painful, usually to the point that the subject jumps

away from the source of stimulation.

At current levels higher than 5 mA, motor nerves are stimulated and the affected muscles contract. At the so-called "let-go" current level, around 10 to 20 mA, muscle fibers are kept in a constantly depolarized condition. The subject then has no ability to control his own muscle actions and he is unable to release his grip on the electrical conductor. Above the "let-go" level, electrical stimulation becomes increasingly painful and mechanical injury may result from the powerful contraction of the skeletal muscles. Despite pain and fatigue, however, the heart and respiratory functions continue.

At about 100 mA, other more life-threatening physiological phenomena occur. One of the more common is ventricular fibrillation, a lack of coordinated action among the muscle fibers of the heart. Fibrillation defeats the heart's ability to pump blood and is fatal unless corrected within minutes. At about 6 amperes or more, though, the heart goes into sustained muscular contraction, much as skeletal muscles do at the let-go level, but when the current ceases, the heart usually reverts to its normal coordinated mode of operation. This phenomenon is used extensively to restore normal rhythm to fibrillating hearts, usually by applying a 1–3 kV, 5 ms pulse to the chest.

Continuous high current levels of 6 amperes or more also cause temporary respiratory paralysis and may cause serious burns if the current density is high. At current levels much above 6 amperes, massive damage is caused by the heating effect of the current flow.

The voltages required to obtain these current levels vary widely because the contact impedance varies from person to person, depending on skin type, contact area, and on other parameters such as whether or not the skin is moist. Typically, the threshold of feeling is from ten to fifty volts.

From the many investigations conducted over the years, 5 mA has become accepted as the maximum that should be allowed to pass through a human being from external contact. Among the many tests that electrical equipment must pass to receive Underwriter Laboratories listing, is one specifying that 60 Hz leakage currents from the power line to the equipment case shall be less than 5 mA. That is, if a person were to touch an electrical instrument or appliance while standing barefoot on wet earth, there should be no more than 5 mA flowing through his body. Nowadays, these leakage currents arise in electronic equipment primarily from capacitive coupling in RF line filters and between the primary winding and core and case of the power transformer. Resistive

<sup>1</sup> 'Medicine and the Law: Fatal Shock from a Cardiac Monitor,' *Lancet* 1:872, 1960.

<sup>2</sup> Bruner, John M. R., 'Hazards of Electrical Apparatus,' *Anesthesiology*, Mar-Apr. 1967.



leakage paths have been reduced significantly by modern insulation materials.

### Internal Current

The preceding has assumed that electrical contact is made outside the body. With the improved instrumentation now available to hospitals, it is common to have electrical contacts made inside the body where fluid electrolytes substantially reduce resistance to current flow. In a modern surgical intensive care unit, for instance, a patient may have four direct connections to his heart to allow measurement of pressures in the various chambers of the heart. This patient would also, most likely, have an electrocardiograph attached externally to his body along with temperature probes, respiration sensors, and perhaps mechanical assist devices like respiration pumps and heart-lung machines. Under these circumstances, there is a possibility that leakage currents might pass directly to the heart. Furthermore, not only is the resistance to current flow reduced by internal electrodes, but the current levels deemed hazardous are much smaller than externally applied hazardous current levels.

Of the many groups concerned with patient safety, most believe that current passing internally through a patient should be limited to less than  $10 \mu\text{A}$ . Investigators at Duke University have shown that a current as small as  $20 \mu\text{A}$  flowing between the right and left ventricles in the hearts of dogs can cause ventricular fibrillation.<sup>3</sup> Although the average current causing ventricular fibrillation in this study was  $170 \mu\text{A}$ , the fact remains that much smaller currents *can* cause fibrillation. Naturally, it is difficult to perform similar experiments with humans but there is good reason to believe that the fibrillatory current may be similar. Since the minimum impedance likely to be found between two electrodes can be as low as 500 ohms, a working group of the National Fire Protection Association recommends that non-therapeutic voltages that a patient may contact should be less than 5 mV.

### Internal Shock Hazards

We are all aware of the hazards posed by common household appliances and power tools, where a leakage path to the case can create a shock hazard, but when we are concerned with microamperes rather than milliamperes, there are many unsuspected ways that shock hazards can arise.

Let us look at some of the situations that can arise in hospitals. Fig. 1 shows a patient in bed with grounded monitoring equipment attached. He reaches over to turn

on his bed lamp, a two-wire lamp that has a leakage current of 1 mA but which still passes all present safety requirements. This 1 mA can pass through his arm, then through his trunk to the grounded patient monitor with a portion going through his heart. In fact, if a grounded electrode were attached to his heart, all of the 1 mA

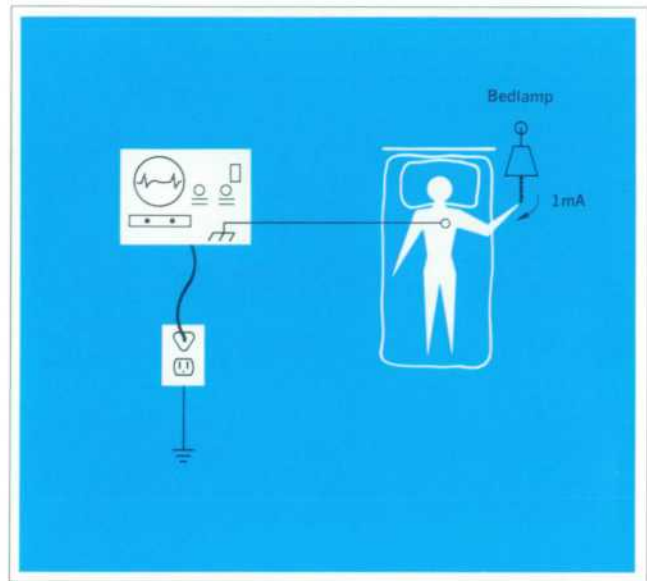

**Fig. 1.** Normally harmless leakage current in lamp can become dangerous if patient has internally attached electrodes.

might flow through his heart, causing immediate ventricular fibrillation. The existence of this leakage path would go undetected, unless a nurse or attendant, accidentally touching both lamp and monitor, also noticed a shock. Who knows how many patients might have been electrocuted before anyone correlated a patient's sudden crisis with touching the lamp? Fortunately, when a patient is monitored, an alarm sounds if his heart starts fibrillating so resuscitation can be started immediately.

A more subtle situation is shown in Fig. 2. Here the patient is on a bed that has electric motors to raise, lower, and adjust his position. A ground wire is broken, so the metal framework may be at some potential other than ground because of capacitive coupling between motor wiring and bed frame. The patient is connected to ground through an ECG monitor, and he has a pacemaker catheter inserted into his heart to synchronize his heart's rhythm. However, the pacemaker is battery operated and is not tied to any ac outlet. So, the patient is safe — so far.

Now suppose the nurse adjusts the wiring on the pacemaker while leaning against the metal bed frame. Obviously, she supplies an electrical path from the bed

<sup>3</sup> Whalen, Robert, Stanner, McIntosh, 'Electrical Hazards Associated with Cardiac Pacing,' Academy of Science Annals, New York, 1964.



frame to the patient's heart and then to the grounded monitor, as shown in the equivalent circuit of Fig. 3. As much as  $100 \mu\text{A}$  could flow through the patient's heart and, as discussed earlier, this could cause ventricular fibrillation.

Had the bed been grounded, there would have been no problem. Equipment in hospitals, however, gets severe use, and it is usually handled by people who do not understand electricity and who do not understand the need for good grounding. The bed, which worked fine because it did not rely on the ground wire for operation, could have had a broken ground wire unnoticed for a long time. The only evidence that something might be wrong might have been excess 60 Hz interference on the monitor oscilloscope. Those using the equipment probably would have assumed the problem was in the monitor or electrodes, and would likely have done nothing further.

Let us look at one more example. Fig. 4 shows a patient grounded by an ECG monitor. Intercardiac blood pressure is also being monitored by a saline-filled catheter inserted through a vein into the patient's heart. The catheter transmits pressure to an external transducer that is connected to a grounded monitoring device in such a way that the saline-column is also connected to ground. The patient's heart is thus effectively tied directly to ground. No problem yet.

It so happens that the patient is in an older hospital where the intensive care unit was converted from a general ward area, requiring the installation of additional electrical outlets. As is common practice, and as permitted by most electrical codes, the ground wire for the new outlets was not connected directly to existing outlets but was routed all the way back to the main distribution panel. In this case, the ECG monitor was connected to an outlet on one grounding system and the pressure monitor was connected to the other grounding system. Still no problem.

Now, along comes the cleanup man with his vacuum cleaner. Vacuum cleaners are notoriously unsafe devices because they are prone to large amounts of residue in their suction motors, and they often pick up debris that may be damp. Over a period of time the motor develops resistive leakage paths from its windings to the vacuum cleaner case although a three-wire power cord prevents the case from rising to a high potential.

This particular vacuum cleaner has developed a leakage path that allows 1 A to flow in the ground wire. This current flows through the ground wire in the outlet back to the power distribution panel 50 feet away. The 12-gauge ground wire has a resistance of 80 milliohms, which

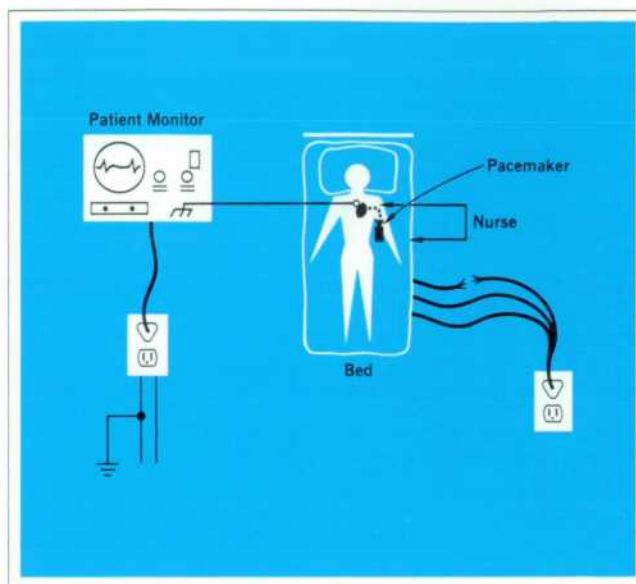

**Fig. 2.** Broken ground wire creates hazardous environment for monitored patient. In this case, nurse unintentionally completes circuit from power line to ground through patient.

means there is a voltage drop of 80 mV from outlet to distribution panel. So now the patient is connected between two grounds that have an 80 mV potential difference. Now there is a problem: if the impedance between the two grounds on the patient were much less than 8000 ohms — and it could be as low as 500 ohms — more than  $10 \mu\text{A}$  would flow.

Here we have an insidious situation in which the patient might have expired without anyone touching him or without his touching a lamp or anything else. The connection between plugging in the vacuum cleaner and the patient's sudden demise is far from obvious. It should be emphasized that the wiring as installed met all requirements of existing electrical codes.

#### Protecting the Patient

The above examples show that where there is direct electrical access to the heart, extreme caution must be observed in attaching electrical monitoring equipment to patients. What can be done to prevent problems from occurring? One way is to prevent, where possible, electrical pathways to the heart. The new Hewlett-Packard Model 1280B/C Pressure Transducers, for example, have dome and diaphragm electrically isolated from the rest of the transducer to provide protection for catheterized patients. Potentials of 120 V at 60 Hz cannot cause more than  $10 \mu\text{A}$  to flow from transducer fittings to the case.

Additional protection can be provided by limiting to less than  $10 \mu\text{A}$  the maximum possible current in all



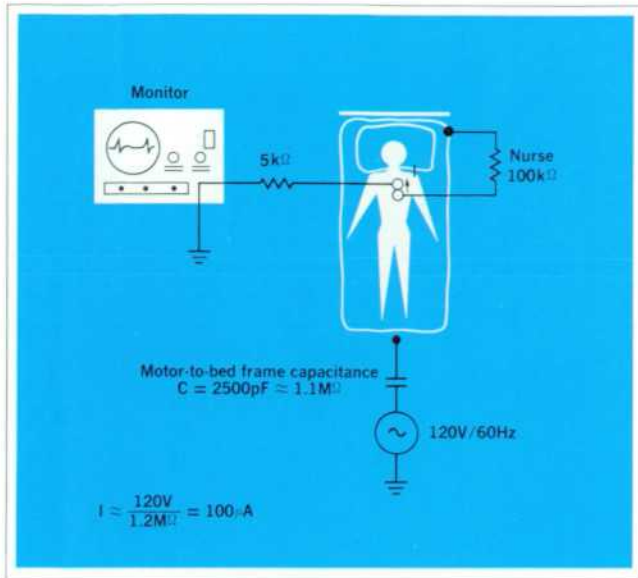

Fig. 3. Equivalent circuit of situation diagrammed in Fig. 2.

leads connected to the patient. Hewlett-Packard electrocardiographs and instruments for patient monitoring (Table II) now have current-limiting circuits that allow no more than  $10 \mu\text{A}$  to flow through patient-connected leads should the patient come in contact with 115 volts,

TABLE II

Hewlett-Packard Instruments with isolated inputs

1500A Portable Electrocardiograph
1511A Mobile Electrocardiograph
1513A Three-channel Electrocardiograph
1514A Three-channel Electrocardiograph/Phonocardiograph
7807B Bedside ECG Patient Monitor
8811A Bio-electric Preamplifier
1280B/C Pressure Transducers

or even 230 volts. This insures that HP equipment does not supply a ground path if the patient comes in contact with voltages produced by other equipment such as beds, TV sets, radios, and electric shavers. The new HP monitoring equipment, by isolating the patient electrically, does not contribute to hazardous situations.

How patient isolation is achieved in this equipment is shown in the diagram of Fig. 5. In much the same way that signal ground is isolated from equipment ground in guarded digital voltmeters, patient leads are isolated from the measuring equipment. The only connection between the patient and equipment ground is through stray capacitance  $C_1$ , which is on the order of 95 picofarads. During the design phase, careful attention was also paid to all

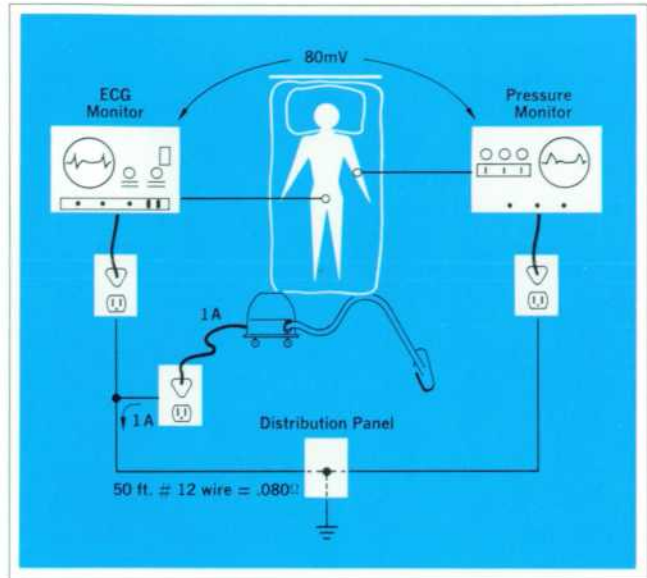

Fig. 4. If all equipment near patient is not connected directly to common ground point, a hazardous situation can develop. Leakage current in vacuum cleaner here is sufficient to create voltage dangerous to patient.

other possible current leakage paths from the isolated input to the rest of the equipment. As a result, the impedance between input circuits and ground is greater than 25 megohms at 60 Hz. This means that if a patient connected to a monitor using this circuitry should come in contact with 115 volts, no more than  $4.6 \mu\text{A}$  could flow through him.

Other isolating techniques are possible, one being the use of optical isolators, as shown in Fig. 6. This technique is not being applied at present because of the relatively high cost.

Another technique uses current-limiting diodes in series with all patient leads, as shown in Fig. 7. Whenever voltages across these diodes exceed the operating range, the only current that can flow is the leakage current through a reversed diode. The problem with this technique at present is the difficulty of manufacturing temperature stable diodes that have both a low impedance in the signal operating range and a reverse leakage current of less than  $10 \mu\text{A}$ .

Careful Grounding

To protect the patient from all sources of electrical shock, regardless of the equipment used, great care must be exercised in the installation and maintenance of equipment within his reach. One way is to connect to one common point all nearby metal surfaces and all electronic devices to which he is attached. This point, referred to as the equipotential patient reference (EPR), is then connected to the hospital grounding system. The EPR

can have a potential with respect to real ground without harm to the patient because he cannot come in contact with any metal object except those tied to the EPR. It is important, however, to limit the length of ground wires connecting the equipment to the EPR and to limit possible current flow in these wires so that the potential difference between equipment and EPR is always less than 5 mV.

Further improvements in an EPR system can be obtained with an isolating transformer, as shown in Fig. 8. Here, even if a leakage path exists in a piece of equipment from the "hot" side to "common" (the EPR), the maximum current that can flow is that permitted by stray capacitance between the isolation transformer windings and in associated wiring.

Also included in this system is a fault detector that monitors the impedance between the EPR and each side of the line. Should the impedance fall below a level that allows just a few milliamperes to flow in the EPR, a warning is set.

Nevertheless, even with the improved protection provided by an EPR, not all hazards are eliminated. If the ground wire connecting the EPR to the chassis of an attached instrument should break, stray capacitance could raise the chassis potential above ground. And, since plugs get yanked out of outlets and power cords get stepped on and kicked around, breaks in ground wires occur far more often than leakage faults in transformers. If the installation were designed so that all leakage currents in the isolation transformer, wiring, and instruments were less than  $10 \mu\text{A}$  (designing a distribution system with less than  $10 \mu\text{A}$  leakage is not easy), the patient would be safe should a ground wire break. Obviously, instruments with isolated inputs provide an important

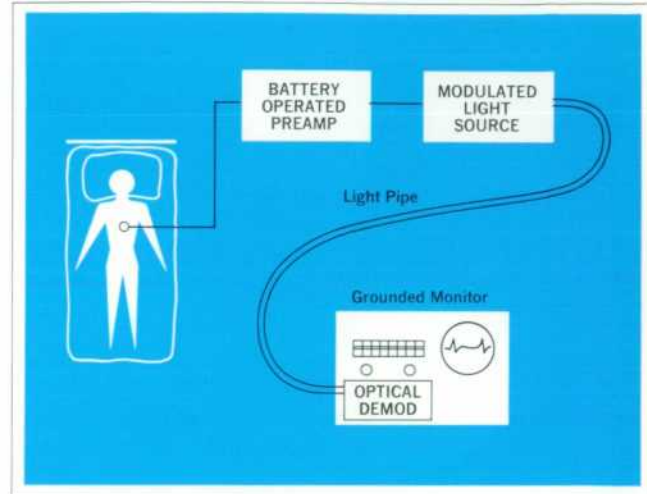

Fig. 6. Excellent isolation can be provided by optical coupling but technique is not economically feasible at present.

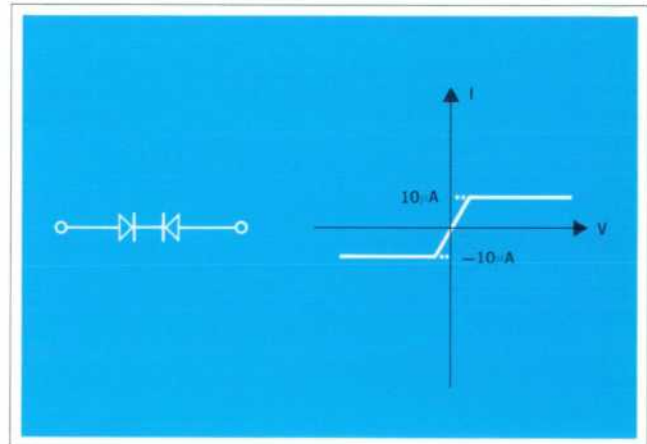

Fig. 7. Back-to-back diodes in series with patient leads can limit current.

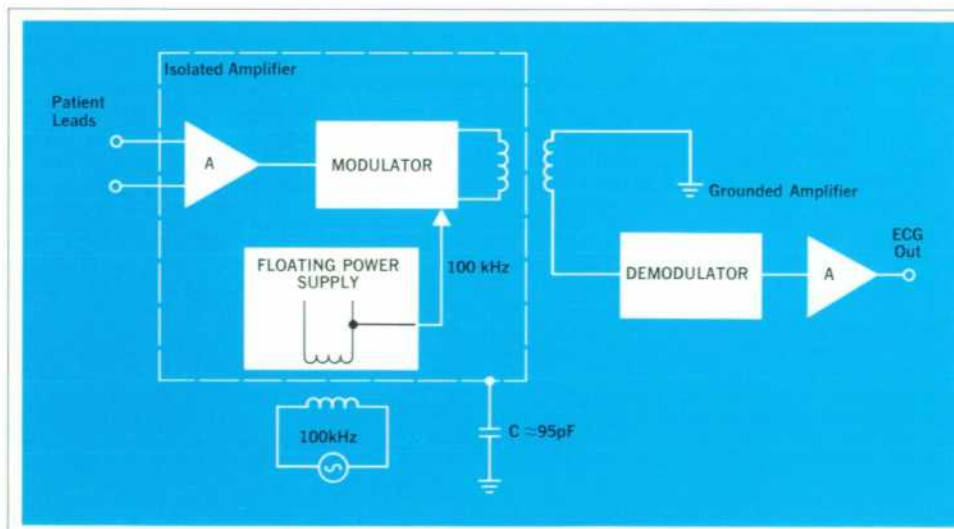

Fig. 5. AC coupling to isolated amplifier eliminates any dc connection between input and output. Input signal modulates 100 kHz carrier for coupling to external circuits. Demodulator recovers original input waveform. Supplying circuit power from 100 kHz oscillator rather than 60 Hz power line reduces need for tight coupling between power transformer windings.



safety factor here, but many installations do not have them. Hence, good grounding practice is not only essential, but frequent inspection of the electrical environment is imperative.

From the preceding, it is obvious that providing good, safe monitoring to patients in hospitals is not a simple task. An outline of precautions that should be observed is presented in Table III.\* The best that can be done is to reduce the risk of accidental electrocution to the lowest

possible level by using a combination of isolated patient circuits and a properly installed and maintained grounding system. These provide a double barrier to electrical accidents. Failure of either one does not place the patient in immediate jeopardy as long as the other is intact. The fault would be found during the next routine inspection of the electrical environment. By making regular inspections, the probability of simultaneous failure of both safety barriers can then be reduced to an acceptably low level. ⚡

**TABLE III**

**Maintaining safe patient electrical environment**

1. Use 3-wire power cords exclusively.
2. Supply all electrical equipment within 15 feet of patient from single bank of wall outlets that have ground terminals tied together by 12 gauge or larger wire.
3. Supply bank of wall outlets from power-line isolation transformer with ground-fault monitor.
4. Abandon all other electrical outlets in vicinity of patient.
5. Connect conductive surfaces of all non-electrical devices within 15 feet of patient to common ground terminal with separate 12 gauge or larger wire for each device. Connect common ground terminal to wall outlet ground.
6. Use monitoring equipment with isolated inputs.
7. Check all power cords for signs of damage. Check for ground continuity from plug to equipment case.
8. With all equipment turned on, measure potential between common ground terminal and all conductive surfaces within 15 feet of patient. No surface should be more than 5 mV from ground.
9. Establish program for periodic inspection of patient environment, including checks on ground continuity, isolation of monitor inputs, and potential on conductive surfaces.

\* Further detailed information on safety procedures is given in Hewlett-Packard Application Note No. 719, to be available in the near future by writing on company letterhead to the Hewlett-Packard Medical Electronics Division, 175 Wyman Street, Waltham, Massachusetts 02154.

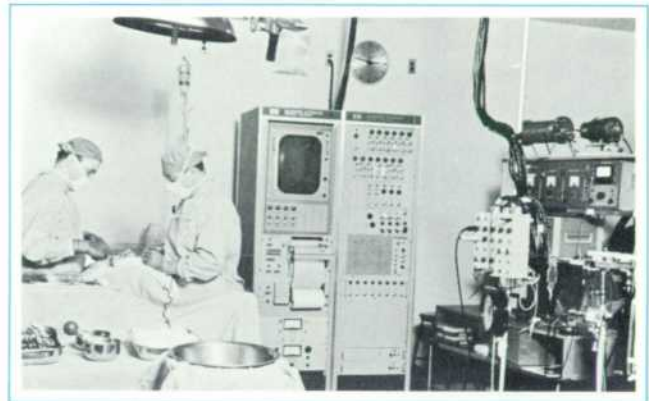

*Operating rooms that use wide array of monitoring equipment also need electrical safety surveillance.*

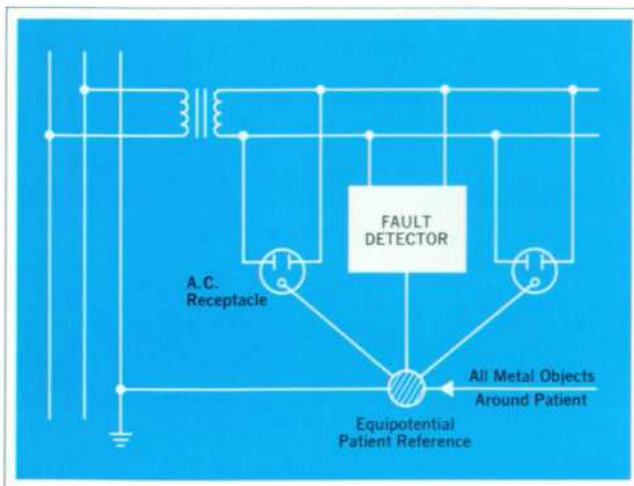

**Fig. 8.** Isolation transformer and single ground point provide safe electrical environment provided that all ground leads are inspected on a regular basis.



**William F. Craven**

Bill Craven, on joining the HP Advanced R and D Labs in 1961, at first investigated oscillator designs and recording techniques and then medical electronics. He contributed to the 7214A Diagnostic Sounder and the 1510A Electromyograph, subsequently transferring to HP's Medical Electronics Division in Waltham, Mass., where he became project leader on the 1510A development. Since then, Bill has contributed to the design of many of the 780-series Patient Monitors and is now in charge of HP's Intensive Care Monitoring Instrument development program.

Bill, who obtained BSEE and MSEE from the University of California just prior to joining HP, has served on several industry committees concerned with patient safety and the standardization of medical instruments. Married and the father of two children, he enjoys skiing, hunting, and fishing in the New England outdoors, and woodworking indoors.

# Calculator Processes Multichannel Analyzer Data

*Two interface cards and a cable connect HP multichannel analyzers to HP's programmable desktop calculator.*

By Norman D. Marschke

MULTICHANNEL ANALYZERS were developed by nuclear scientists to measure the distribution of pulse heights in the outputs of nuclear radiation detectors. Subsequently, experimenters in other fields discovered applications for them, and now they are used not only in physics but also in chemistry, biology, electronics, and other disciplines. Pulse height analysis remains their principal function, but they are also doing such things as signal averaging, measuring time-interval distributions, recording pulse-rate variations with time, and determining amplitude probability distributions.

A multichannel analyzer is a digital instrument, and it produces its results—normally some form of histogram (see Fig. 1)—in digital form. Numerical techniques are sometimes used to extract information from these results, and a computer has usually been required to carry out this data reduction.

Now there is an alternative to the computer for processing data from Hewlett-Packard multichannel analyzers. An interface has been developed to transfer data from the HP 5400A and 5401A Multichannel Analyzers<sup>1</sup> directly to the HP 9100A/B Calculator<sup>2</sup> (see Fig. 2). The calculator is programmable, easy to use, and fast. It can perform many of the necessary calculations just as well as a computer, but its cost is much lower and it doesn't require expert knowledge of a special programming language.

With the interface installed, experimental data can be entered into the calculator either from the keyboard or remotely, directly from the analyzer. Results of computations are shown on the calculator's CRT display. Completely automatic operation is possible with the calculator starting and stopping the analyzer and controlling the transfer of data.

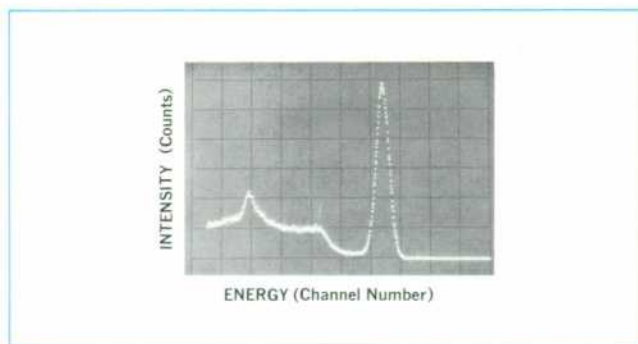

**Fig. 1.** Gamma-ray spectrum of Cs<sup>137</sup> as seen by a scintillation detector is typical of multichannel-analyzer results. The information of interest—the energy and intensity of each peak—can't be read directly; it has to be extracted by computation.

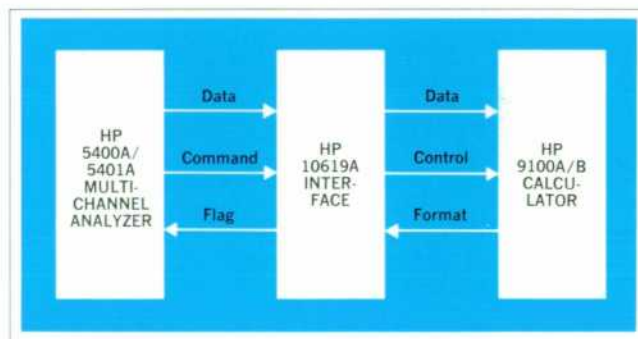

**Fig. 2.** Two interface cards plugged into the multichannel analyzer allow it to communicate with the HP calculator. The calculator is programmable, easy to use, and fast, and it can reduce most analyzer data just as well as a computer.

## Details of Operation

The interface consists of a control board, a data converter board, and an interconnecting cable. The two circuit boards plug into the HP 5400A and 5401A Multichannel Analyzer input/output card cages. The cable



connects from the rear of the analyzer to the rear of the calculator. No modifications are required to either instrument.

Data transmission is initiated by a **FORMAT** command from the calculator keyboard or stored program. A channel of data (6 digits) from the analyzer is then sent to the calculator, followed by a **CONTINUE** entry to resume the calculator program. The next **FORMAT** command causes the next channel of data to be entered, and so on (see flow chart, Fig. 3).

Two special entries are available for Model 5401A; these can be selected by means of a switch on the interface control board. First, the very first data entry can be the starting channel number of the multichannel analyzer data. And second, after the final data entry, a **SET FLAG-CONTINUE** command can be entered by the interface. This can be used to cause a conditional branch in the calculator program.

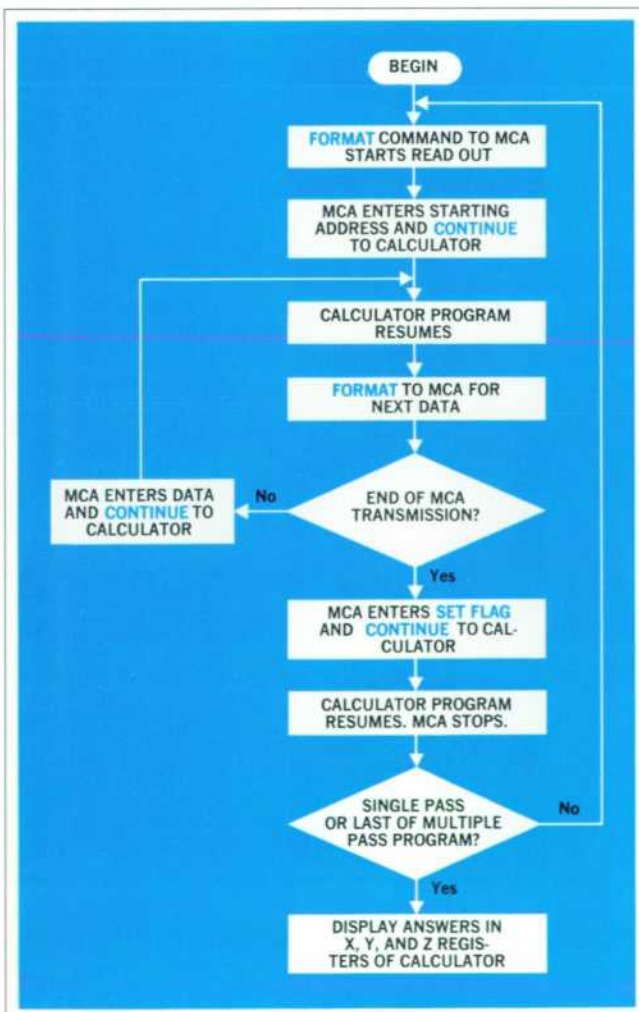

Fig. 3. Simplified flow chart of multichannel-analyzer/calculator operation.

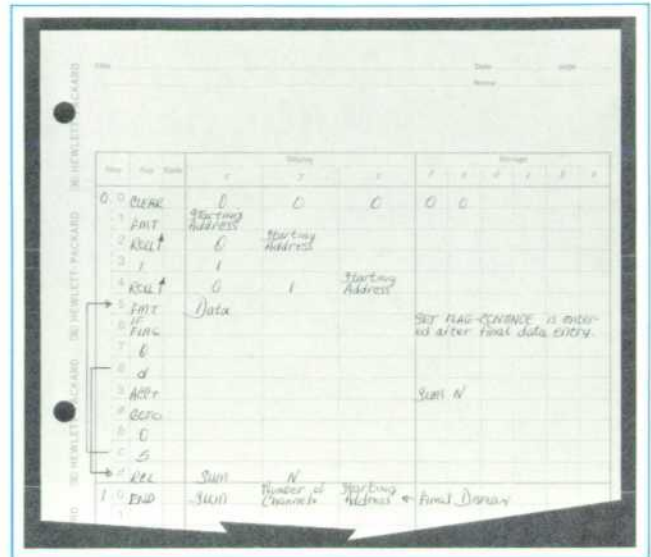

Fig. 4. This program causes the calculator to totalize the data in N selected multichannel-analyzer channels.

### Programming — an Example

Programming the HP calculator is relatively easy, even for a novice. Once written, programs can be recorded on magnetic cards for future use.

Fig. 4 is an example of a simple program for the analyzer/calculator system. It causes the calculator to totalize the data in N selected multichannel analyzer channels. After the program has been run the calculator displays the total count, the number of channels and the address of the first channel.

### Programs for Nuclear Experiments

Nuclear radiation experiments, the first multichannel analyzer applications, are still among the most important. In a typical experiment the output of a radiation detector

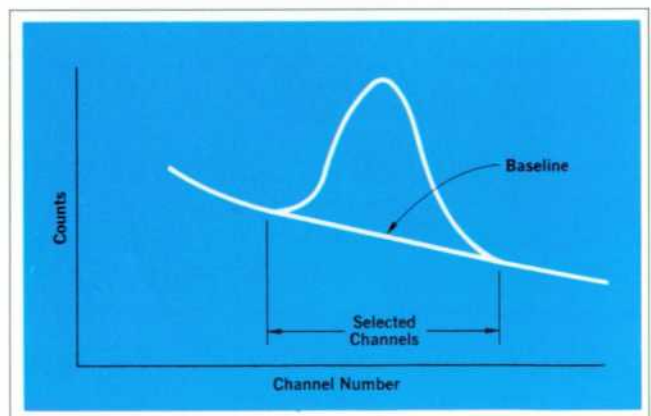

Fig. 5. Typical of the tasks the calculator can do is fitting a baseline to a peak, then subtracting the baseline to leave only the significant data.



is accumulated by a multichannel analyzer for a preset period of time. The resulting histogram is a spectrum, or energy distribution, giving radiation intensity (counts) versus energy (channel number). Data reduction involves the use of numerical techniques to find the energy and intensity of each peak in the spectrum, thereby identifying the radioactive sources and their intensities. This is not as simple as it seems, since the peaks overlap to some extent, and since the shape of each peak must be taken into account.

Several calculator programs have been written for reduction of multichannel analyzer data. One of these locates and measures a spectral peak. To do this, the multichannel analyzer memory sub-group thumbwheels are set to bracket the peak (see Fig. 5). The calculator then makes two passes through the selected data. On the first pass the calculator fits a baseline between the endpoints of the spectral peak. During the second pass, the baseline is subtracted from the data leaving just the peak. Then the program calculates the net area under the peak, the centroid location, and the standard deviation, or width of the peak. This double pass program takes about 10 seconds to process a spectral peak spread over 100 data points.

Once the channel of the peak centroid is located and the area under the peak is found, another program converts this information to peak energy and count rate. To do this, the channel locations and energies of two reference peaks and the counting time of the spectrum are entered into the calculator. The calculator uses this information to convert the centroid and area information from the peak-location program into energy and counts-per-second information. Thus a large amount of multichannel analyzer data is easily and quickly reduced to quantities that have real physical significance.

#### Acknowledgment

W. A. 'Skip' Ross contributed the calculator programs and assisted in developing the hardware. 

#### References

- [1] W. A. Ross, 'A Multichannel Pulse-Height Analyzer with a Very Fast Analog-Digital Converter,' **Hewlett-Packard Journal**, March 1968.
- [2] R. E. Monnier, 'A New Electronic Calculator with Computerlike Capabilities,' **Hewlett-Packard Journal**, September 1968.

## SPECIFICATIONS

### HP Model 10619A Interface

**DATA TRANSFER MODE:** 5400A/5401A to 9100A/B  
**DATA TRANSFER TIME:** <30 ms/channel  
**DATA TRANSFER REQUEST:** FMT command from Calculator  
**DATA TRANSFER FORMAT:**

CALCULATOR TRANSMITS:	ANALYZER TRANSMITS:	
FORMAT	Address of first channel	}
	CONTINUE	
FORMAT	Content of first channel	}
	CONTINUE	
FORMAT FORMAT	Content of last channel	}
	CONTINUE	
FORMAT	SET FLAG	}
	CONTINUE	

\* These interchanges between analyzer and calculator may be suppressed by a jumper on the control board. They are available only with the 5401A Multichannel Analyzer, not with the 5400A.

#### MULTICHANNEL ANALYZER CONTROL

A FORMAT command causes the MCA to start if it is not running. After transmitting the last output (SET FLAG) the MCA stops.

**PRICE: \$500.00.** TENTATIVE

### HP Model 5375A Keyboard

**PRICES:** Model 5375A, \$1350.00. Model 5360A Computing Counter, \$6500.00. Model 5379A Time Interval Plug-in, \$750.00.

**MANUFACTURING DIVISION:** SANTA CLARA DIVISION  
 5301 Stevens Creek Boulevard  
 Santa Clara, California 95050

### Norman D. Marschke



Norm Marschke received his BSEE in 1963 and his MSEE in 1964 from the University of Michigan. While at school he was elected to Tau Beta Pi, Eta Kappa Nu, and Phi Kappa Phi.

After graduation, Norm came to Hewlett-Packard to work on high frequency counters. Later he joined the digital signal analysis group, where he was project leader for the digital processor in the 5400A/5401A Multichannel Analyzers and for the Analyzer/Calculator Inter-

face. At present he is a project leader in HP's Santa Clara Division.

Norm is outdoor-minded when he isn't working. Skiing is his favorite winter activity, and in the summer he can be found out on San Francisco Bay, sailing his Super Satellite.

## HEWLETT-PACKARD JOURNAL MARCH 1970 Volume 21 • Number 7

TECHNICAL INFORMATION FROM THE LABORATORIES OF THE HEWLETT-PACKARD COMPANY PUBLISHED AT 1501 PAGE MILL ROAD, PALO ALTO, CALIFORNIA 94304  
 Editor: R. H. Snyder Editorial Board: R. P. Dolan, H. L. Roberts, L. D. Shergalis Art Director: Arvid A. Danielson Assistant: Maridel Jordan