

HEWLETT-PACKARD JOURNAL

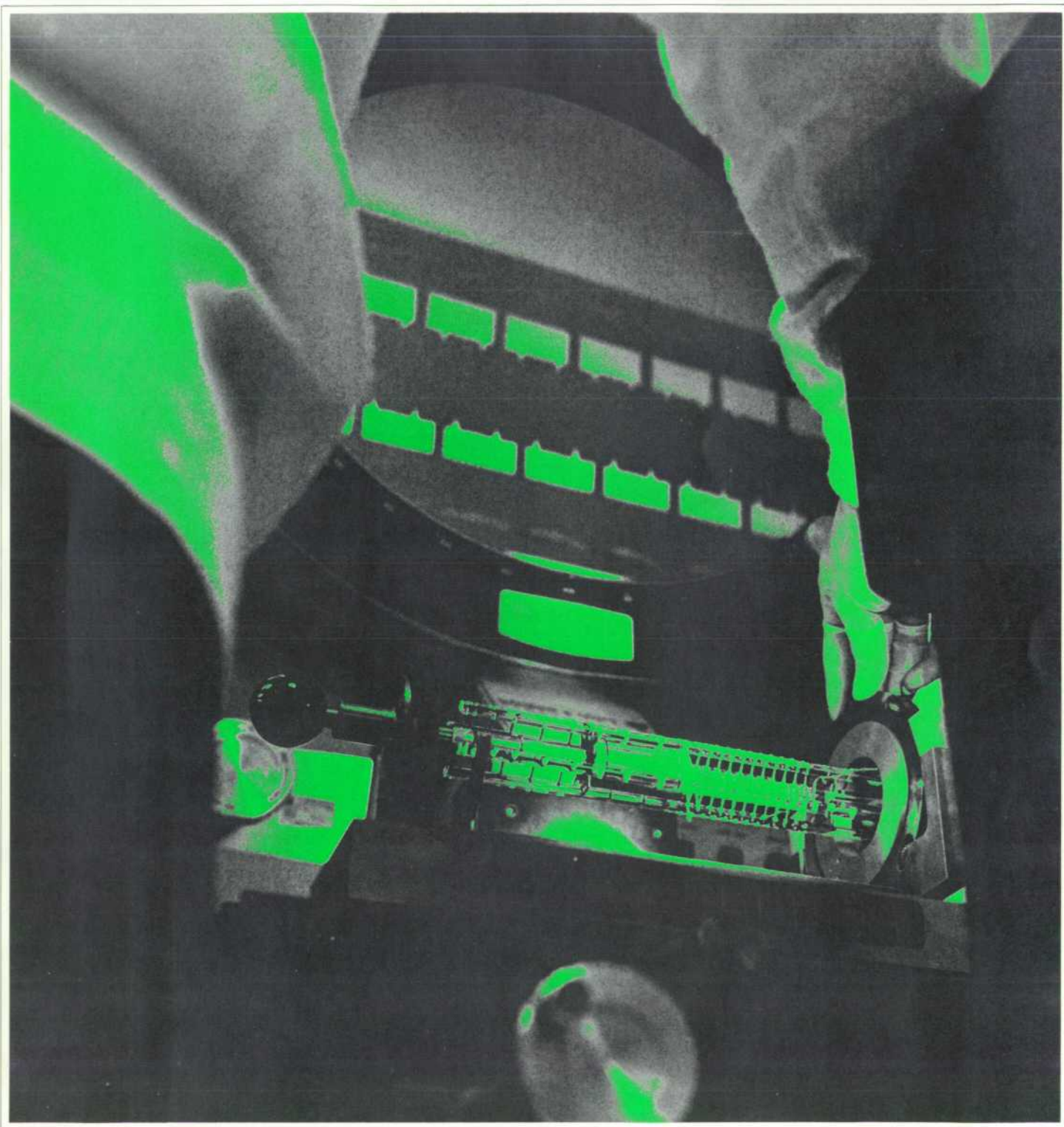

JANUARY 1970

A DC-to-VHF Oscilloscope

Displaying intermittent pulse trains with nanosecond risetimes, capturing fast transients, a predetector look at amplitude-modulated carriers — these are some of the tasks performed by a new general-purpose oscilloscope that has dc–250 MHz bandwidth and 10 mV/cm sensitivity.

By James Pettit

WHEREVER THE SHAPE OF A WAVEFORM IS IMPORTANT, the oscilloscope is the engineer's favorite instrument — it's his window into the world of circuit behavior. But as waveform transitions get faster and faster, oscilloscope designers are hard-pressed to supply instruments that have the requisite bandwidth along with the sensitivity, versatility, ease of use and calibrated performance that engineers have come to expect in oscilloscopes.

One answer to the problem of capturing and displaying high-frequency complex signals has been the sampling scope. These instruments have been refined to the point that they can display signals with frequency components higher than 12.4 GHz and transition times shorter than 28 ps.¹ Sampling scopes, however, satisfy basic display requirements only when the signal repetition rate is high enough to provide a usable display — the need for 1000 or so samples per scan takes too much time if the sampling rate is much less than 10 kHz.

For viewing single-shot events or fast signals with low repetition rates, realtime high-frequency oscilloscope performance is needed. This kind of performance has always been required by experimenters concerned with high energy physics but the need is now being intensified by the computer industry, as clock rates soar to 100 MHz and pulse risetimes shrink to nanoseconds.

This heightened need has sparked the development of a new oscilloscope, one that has realtime response beyond 250 MHz, but which also has plug-in versatility, sensitivity (10 mV/cm), and convenient size. Further-

more, the new scope will be capable of 500 MHz response whenever technological advances in solid-state amplifier design permit — the cathode-ray tube is capable of response beyond 500 MHz, and it has a writing speed of 4 ns/cm.

The 180 System

The new 250 MHz Oscilloscope, Model 183A, is an outgrowth of the Hewlett-Packard Model 180A Oscilloscope system, developed four years ago.² The objective at that time was to develop a state-of-the-art oscilloscope that was compact, light, versatile, and easy-to-use. These requirements could only be met by an all solid-state design which, until then, had not seemed practical for a high-frequency oscilloscope. However, development of the mesh electrode technique in CRT's, which reduced deflection voltage requirements, and development of field-effect transistors with the gain-bandwidth needed for front-end use, made the all solid-state design possible.

The 180A was introduced in mid-1966, and the success of the design is attested to by its wide acceptance. At the time it was developed, frequency response to 50 MHz was considered adequate for the great majority of applications. The response was upped to 100 MHz last year by the Model 1802A plug-in but the demand for oscilloscope performance into the hundreds of megacycles continues to grow. Since the 180A's CRT has a frequency response up to about 150 MHz, higher frequency performance would require a new CRT.

¹A. Best, D. Howard, J. Umphrey, 'An Ultra-Wideband Oscilloscope Based on an Advanced Sampling Device,' *Hewlett-Packard Journal*, Vol. 18, No. 2, Oct. 1966.

²Floyd G. Siegel, 'A New DC-50+ MHz Transistorized Oscilloscope of Basic Instrumentation Character,' *Hewlett-Packard Journal*, Vol. 17, No. 12, Aug. 1966.



Fig. 1. *New Model 183A Oscilloscope mainframe with 1830A and 1840A plug-ins has dual-channel, 250 MHz, 10 mV/cm response and sweep times to 1 ns/cm (with mainframe $\times 10$ magnifier). Scope has 4 ns/cm photographic writing rate.*

The Model 183A

The new CRT developed for the 183A, described more fully on page 9, is two inches longer than the 180 CRT. Hence, the mainframe had to be redesigned and, because of the higher frequency performance permitted by the new CRT, two new plug-ins were developed. The Model 1830A Amplifier plug-in provides dual channel, 250 MHz bandwidth performance at deflection factors as sensitive as 10 mV/cm. Sweep times commensurate with the high-frequency response are provided by the Model 1840A Time Base: 10 ns/cm, expandable to 1 ns/cm with the mainframe X10 magnifier. What is more, the new Time Base triggers reliably on signal frequencies as high as 500 MHz (Fig. 2). Thus have high-speed measurement needs of the future been met, as well as those of the present.

Of particular importance, the 183A accepts all the plug-ins already designed for the 180A, including the 50 MHz Four-channel amplifier, Differential/DC Offset amplifier, delaying sweep time bases, and dual-width TDR/Sampling plug-in.

Writing Speed

For capturing high speed single transients or low repetition rate fast rise pulses, the most significant system parameter other than bandwidth is photographic writing speed. Not only does this define the system's ability to photograph a fast transient but it also indicates the brightness of low repetition rate waveforms that one may wish to observe visually.

How brightness is achieved in the new 183A CRT is described in the article on page 9. One factor in the fast writing rate of this tube is the use of an internal flood gun for illuminating the entire phosphor surface, which raises the threshold level of the phosphor. Flood gun illumination also 'fogs' photographic film, effectively

Cover: Operator uses optical comparator to check alignment of helical electrodes in new 250MHz Oscilloscope's cathode-ray tube, described in this issue.

In this Issue:

A DC-to-VHF Oscilloscope **page 2**
A Fast-Writing, High-Frequency Cathode-Ray Tube **page 9**
A Wideband Oscilloscope Amplifier . . . **page 11**
Monolithic Transistor Arrays for High-Frequency Applications **page 15**
A Fast Time Base for a High-Frequency Oscilloscope **page 17**

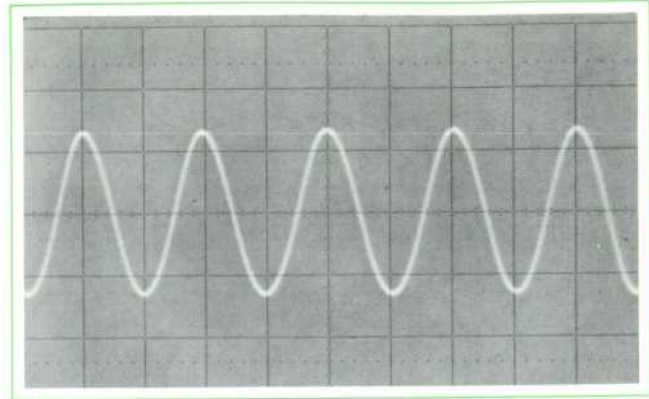

Fig. 2. Scope photo of 500 MHz sine wave shows low jitter of new 1840A Time Base trigger circuit in Model 183A Oscilloscope.

enhancing its sensitivity (Fig. 3). The flood gun can be operated continuously, to delineate the internal black graticule, or it can be pulsed in synchronism with the sweep for single-shot events.

To complement the fast writing rate, a new Camera (Model 195A), with a fast f1.3 lens, has been designed. With this Camera, 10,000 ASA film, and P31 phosphor in the CRT, the 183A Oscilloscope achieves 4 cm/ns writing speed, using the pulsed flood gun.

Input Characteristics

In keeping with the growing practice of using 50-ohm circuits for fast pulses and high-frequency signals, the inputs to the new 183A system plug-ins are matched to 50 ohms, and hence add negligible distortion when used in 50-ohm systems (Fig. 4).

For probing in high-impedance circuits, a new 500 MHz active Probe is available.³ This Probe translates its 100k ohm/3 pF input into 50 ohms, and it has a bandwidth of dc to 500 MHz. Inexpensive low-capacitance resistive dividers for the 50-ohm input can also be used for probing. These have 0.7 pF shunt capacitance and dc input resistance from 250 ohm (5:1 attenuation) to 5k ohm (100:1 attenuation).

The new scope has the sensitivity required of a general-purpose instrument—its minimum deflection factor is 10 mV/cm, expandable in 7 steps to 1 V/cm. For examining larger signals, compensated dividers for the active Probe allow a deflection factor of 100 V/cm (maximum allowable input is ± 350 V). A low-cost high-impedance probe that has a wide dynamic range but is suitable only for frequencies below 50 MHz, will be available soon.

³Joel Zellmer, 'High Impedance Probing to 500 MHz,' *Hewlett-Packard Journal*, Vol. 21, No. 4, Dec. 1969.

Mainframe Characteristics

In basic concept, the new 183A is like the 180A. A system block diagram is shown in Fig. 5. Like the 180A, the 183A allows for future circuit developments by placing all CRT vertical drive circuits in the plug-ins. The time resolution (1 ns/cm) needed for future high-frequency developments is already available with the new Time Base and mainframe horizontal amplifier.

The new cathode ray tube is two inches longer than the original 180A CRT, thus requiring the Model 183A mainframe to be longer than the 180A, but with no change in height or width. The extra length is used for added power supply capability to meet the heavier current demand of high-frequency circuits.

To match the scope's high-frequency performance, the horizontal amplifier and unblanking circuits in the mainframe were redesigned. Horizontal sweep amplifier bandwidth was extended to >30 MHz with clamping for fast recovery to achieve 1 ns/cm sweep capability.

Fully Specified Calibrating Waveform

Calibrators have been a standard feature on quality oscilloscopes for a number of years, put there to assure continuing accuracy in a scope's amplifiers, attenuators, and time bases. The new calibrator in the 183A goes one step further—it also provides a check on the scope's high-frequency performance. This is done by generating the calibrating waveform with a risetime of <1 ns, commensurate with the scopes risetime (<1.5 ns). The calibrating waveform, a 10% duty factor pulse train with a switch-selected amplitude of either 50 or 500 mV (into 50 ohms), is generated by conventional transistor circuits but with monolithic transistor arrays in a thin-film hybrid structure. This construction obtains a clean waveform with less than 3% overshoot and ringing (measured with 1-GHz bandwidth). Pulse repetition rate is internally generated at either 1 MHz or 2 kHz, selected by a front-panel pushbutton, or the waveform shaper can be driven by external signals at any rate up to 10 MHz.

Compatibility with all 180 System Plug-ins

To provide all the flexibility that a plug-in scope design promises, a major design goal in the 183A development was to make it compatible with all existing 180 system plug-ins. This was not as straightforward as one might surmise, because of the vertical deflection system—the 183A's CRT uses a traveling-wave deflection structure that behaves electrically as a transmission line with

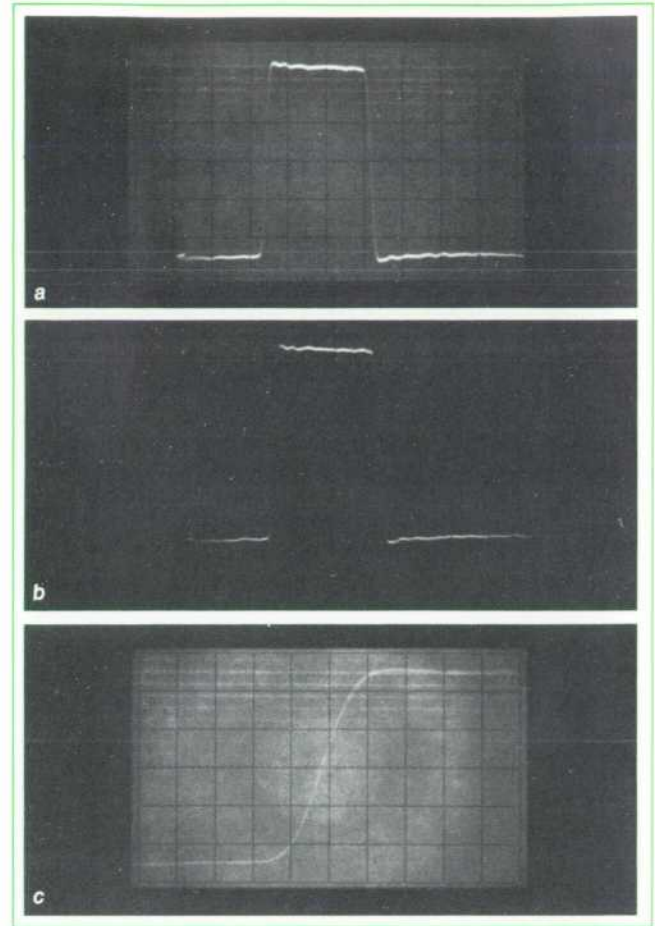

Fig. 3. Automatic film and phosphor 'fogging' with internal CRT flood gun increases single-shot trace writing rate (A) over that obtained without flood gun (B). Leading and trailing edges of fast pulse ($t_r = 1.5$ ns) become visible with flood gun illumination. (Sweep time: 10 ns/cm.) Photo C shows one sweep of same pulse with 1 ns/cm sweep time.

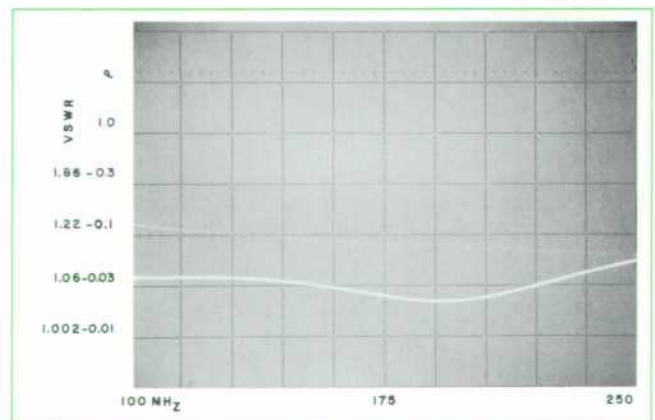

Fig. 4. VSWR and reflection coefficient vs frequency for 50-ohm inputs of Model 1830A Dual Channel Vertical Amplifier on 50 mV/cm range. (Measurement was made with Hewlett-Packard Model 1810A Network Analyzer.)

a characteristic impedance of 330 ohms, whereas earlier plug-ins in the 180 system were designed to drive a high-impedance capacitive load. As shown in Fig. 7, the 183A deflection system includes switching circuits that terminate the transmission line when the 1830A 250-MHz Amplifier is used, but which make the deflection structure look like a conventional high-impedance structure when other plug-ins are used.

The switching works as follows: with the 1830A 250-MHz Amplifier in place, diodes D1 through D4 (low capacitance PIN diodes) are biased off and diodes D5–D6 are biased on, connecting the deflection electrodes to the terminating resistors. With other plug-ins in place, diodes D1–D4 are biased on, tying together the input and output ends of the deflection electrodes. Diodes D5–D6 are then back biased to remove the terminating resistors. The deflection system then behaves as a pair of conventional deflection electrodes. Diode switching is automatically performed by circuits that are completed through the mainframe connectors when a plug-in is installed.

(Text continued on page 8.)

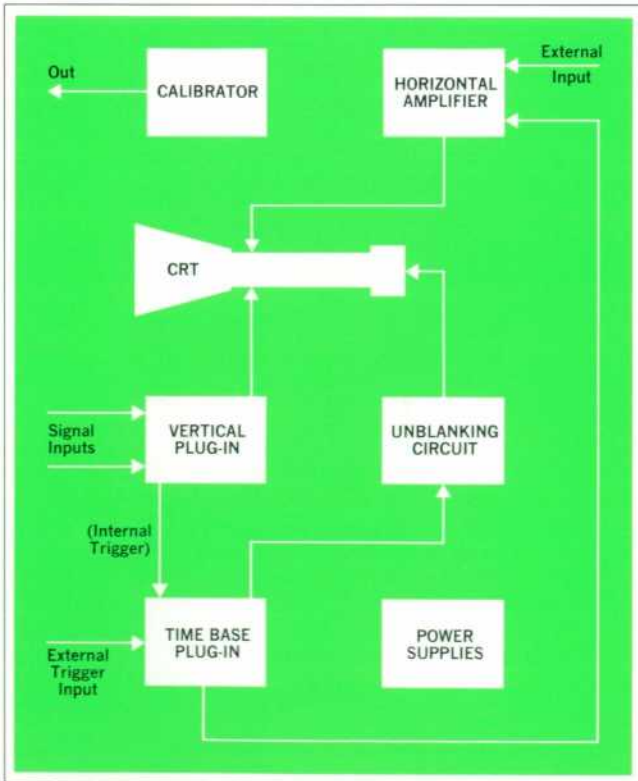

Fig. 5. Block diagram of Model 183A Oscilloscope with two plug-ins. All vertical drive circuits are in plug-in, allowing scope frequency response to be extended whenever higher frequency plug-ins become technologically feasible.

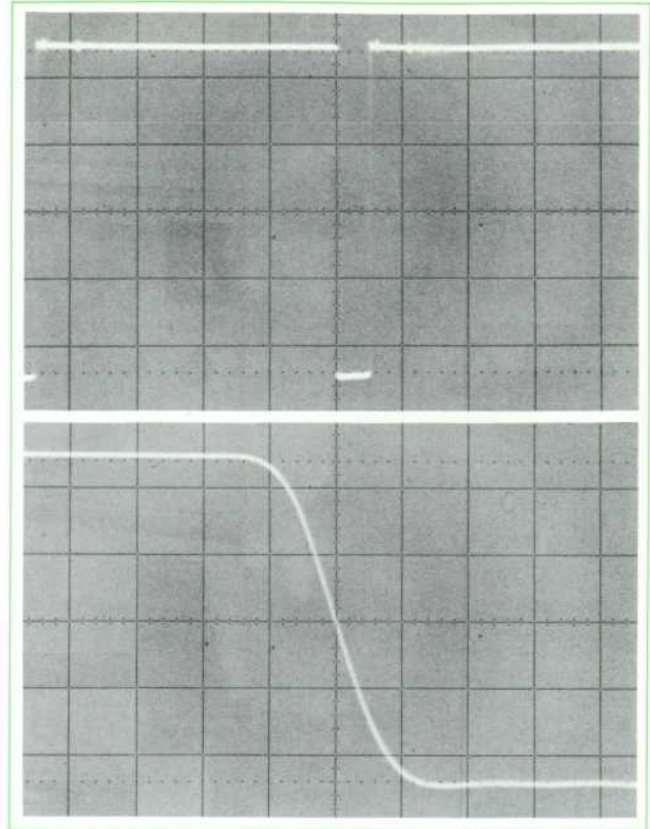

Fig. 6. Calibrating waveform. Sweep time in upper photo is 0.2 $\mu\text{s}/\text{cm}$; in lower photo it is 1 ns/cm. Fast risetime provides check on scope's frequency response. Clean waveform is also useful as test signal for external equipment.

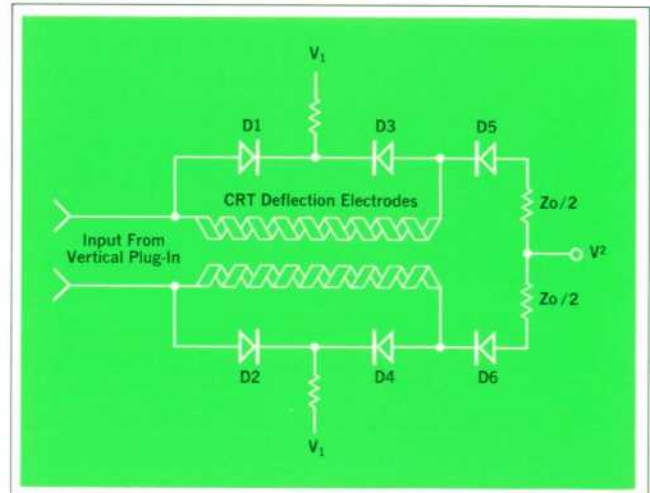

Fig. 7. Diodes switch CRT deflection electrodes to match amplifier source impedance. When Model 1830A plug-in is used, voltages V_1 and V_2 are both higher than deflection electrode voltage, connecting electrodes to terminating impedance Z_o . With other plug-ins, V_1 and V_2 are lower than electrode voltage, shorting electrodes end to end and disconnecting Z_o .

SPECIFICATIONS

HP Model 183A/B Oscilloscope (Mainframe)

CATHODE-RAY TUBE AND CONTROLS

TYPE: Post accelerator, 20 kV accelerating potential; aluminized P31 phosphor (P2, P7, P11 available); safety glass faceplate.
GRATICULE: 6 x 10 division parallax-free internal graticule. 1 div = 1 cm. 0.2 division subdivisions on major axes. SCALE control adjusts flood gun that illuminates CRT phosphor. Normal or pulsed flood gun operation selected by rear-panel switch.
BEAM FINDER: Returns trace to CRT screen regardless of horizontal or vertical position control settings.
INTENSITY MODULATION: Approximately +2 V dc blanks trace of normal intensity (to 15 MHz). +15 V blanks any intensity trace. Input R, 4.7 k ohms.

CALIBRATOR

PULSE TIMING:
Mode 1: rep rate 2 kHz (0.5 ms period), pulse width 50 μ s.
Mode 2: rep rate 1 MHz (1 μ s period), pulse width 100 ns. ($\pm 0.5\%$ 10°C to 40°C, $\pm 1.0\%$ 0°C to +55°C).
AMPLITUDE: Selectable 50 mV and 500 mV, $\pm 1\%$ into 50 $\pm 0.5\%$ ohms.
SOURCE IMPEDANCE: 50 ohms.
PULSE SHAPE (measured with 1 GHz bandwidth):
Risetime (neg), <1 ns.
Overshoot and ringing, $\pm 3\%$ max.,
Flatness (pulse top and baseline with perturbations averaged), $\pm 0.5\%$ after 5 ns.
EXTERNAL CALIBRATOR INPUT: Rear-panel input selectable with rear-panel switch. Front-panel light indicates when switch is in EXT position. Calibrator shapes external negative inputs that exceed -0.5 V peak. Rep rate extends to >10 MHz. Input impedance approximately 10 k Ω .

HORIZONTAL MAINFRAME AMPLIFIER

BANDWIDTH: DC-coupled, dc to 8 MHz. AC-coupled, 2 Hz to 8 MHz.
DEFLECTION FACTOR: 1.0 V/div in X1, 0.1 V/div in X10 ($\pm 3\%$ with Vernier in CAL position). Vernier provides continuous adjustment between ranges and extends deflection factor to 10 V/div. Dynamic range: ± 20 V.
INPUT IMPEDANCE: Approximately 1 megohm shunted by 20 pF.
MAXIMUM INPUT: 350 V (dc + peak ac).
SWEEP MAGNIFIER: X1 and X10; magnified sweep accuracy, $\pm 5\%$ (with $\pm 3\%$ accuracy time base plug-in).
OUTPUTS: On rear panel for main and delayed gates (vertical and horizontal outputs when used with sampling plug-ins). Approx. 0.75 V with 1840A Time Base; outputs drive impedances of 1000 ohms or greater without distortion.

GENERAL

DIMENSIONS:
Cabinet (183A), 7 $\frac{7}{8}$ in wide, 11 $\frac{1}{8}$ in high, 23 $\frac{3}{8}$ in deep behind panel (200 x 289 x 594 mm)
Rack (183B), 19 in wide, 5 $\frac{1}{4}$ in high, 21 $\frac{3}{8}$ in deep behind panel (483 x 133 x 543 mm); 23 $\frac{3}{8}$ in deep overall.
WEIGHT (without plug-ins): Model 183A, net 33 lb (15 kg); shipping 46 lb (20.9 kg). Model 183B, net 35 lb (15.9 kg); shipping 48 lb (21.8 kg).
ENVIRONMENT: Operates within specifications over following ranges.
Temperature, 0°C to +55°C.
Humidity, to 95% relative humidity to 40°C.
Altitude, to 15,000 feet.
Vibration, in three planes for 15 minutes each with 0.010 inch excursion, 10 to 55 Hz.
POWER: 115 or 230 V $\pm 10\%$, 50 to 400 Hz, less than 170 watts with plug-ins at normal line.
PRICE: HP Model 183A (cabinet), \$1750.00. HP Model 183B (rack), \$1825.00.

ACCESSORIES:

MODEL 10020A MINIATURE RESISTIVE DIVIDER KIT, with 6 replaceable divider tips, BNC adapter tip, blocking capacitor, 4-ft. cable, ground lead, \$100.
MODEL 1120A 500 MHz PROBE, with 10:1 and 100:1 <1-pF divider tips, 27 MHz bandwidth limiter, hoop tip, spanner tip, BNC adapter, ground lead, mounting bracket. \$350.

HP Model 1830A

Dual Channel Amplifier Plug-in

MODES OF OPERATION

Channel A alone; Channel B alone; Channels A and B displayed alternately on successive sweeps (ALT); Channels A and B displayed simultaneously by switching between channels at rate of approx. 250 kHz (chop); Channel A plus Channel B; Channel A minus Channel B.

EACH CHANNEL

BANDWIDTH: DC to 250 MHz, 3 dB down from 6 div reference signal, 50-ohm source.
RISETIME: ≤ 1.5 ns. 10% to 90% with 6 div input step, 50-ohm source.
DEFLECTION FACTOR: From 0.01 V/div to 1 V/div in 1, 2, 5 sequence (7 ranges). $\pm 3\%$ accuracy; calibration adjustment on front panel. Vernier continuously variable between all ranges, extends deflection factor to 2.5 V/div. UNCAL light indicates when Vernier is not in calibrated position.
POLARITY: Selectable + up or - up on Channel B.
A + B or A - B OPERATION: Amplifier meets independent channel specifications for risetime and bandwidth.
SIGNAL DELAY: >55 ns to allow viewing leading edge of waveform that triggers sweep.
INPUT CHARACTERISTICS: Reflection coefficient (measured with 1 ns TDR risetime), $\leq 10\%$ on 10 mV/div and $\leq 5\%$ from 20 mV/div to 1.0 V/div. VSWR ≤ 1.30 on 10 mV/div and ≤ 1.20 from 20 mV/div to 1.0 V/div at 250 MHz.
MAXIMUM INPUT: 5 volts rms or ± 500 divisions peak, whichever is less.
PROBE POWER: Provides power for operating two Model 1120A probes.
DC DRIFT: Short term drift/min and long term drift/hr ≤ 0.05 div after $\frac{1}{2}$ hr from turn-on at constant ambient temperature.
TRIGGERING: Channel A or composite (on displayed signal).

GENERAL

WEIGHT: Net, 5 lb (2.3 kg); shipping, 8 lb (3.6 kg).
ENVIRONMENT: Same as Model 183A/B.
PRICE: HP Model 1830A, \$850.00.

HP Model 1840A

Time Base Plug-in

SWEEP

RANGES: 10 ns/div to 0.1 s/div in 1, 2, 5 sequence; $\pm 3\%$ accuracy with Vernier in calibrated position. Mainframe magnifier extends fastest sweep time to 1 ns/div with $\pm 5\%$ accuracy.
VERNIER: Continuously variable between all ranges, extends slowest sweep to at least 0.25 s/div.

TRIGGERING

NORMAL:
Internal, dc to >250 MHz with 1830A plug-in and signals producing 1 div or more vertical deflection.
External, dc to >250 MHz with signals of 20 mV peak-to-peak or more, increasing to 50 mV at 500 MHz. Input impedance 50 ohms.
AUTOMATIC: Bright baseline displayed in absence of trigger signal. Triggering same as normal except low frequency limit is 5 Hz for internal and external triggering.
SINGLE SWEEP: Selectable with front panel switch; reset pushbutton with armed indicator light. Rear panel input provides remote arming.
TRIGGER LEVEL AND SLOPE:
Internal, any point on vertical waveform displayed.
External, trigger level continuously variable from +0.1 V to -0.1 V on either slope of sync signal; from +1.0 V to -1.0 V in $\div 10$ setting.
COUPLING: Front panel selection of ac or dc. AC attenuates signals below approximately 5 kHz.
VARIABLE HOLD OFF: Time between sweeps continuously variable, exceeding one full sweep on all ranges. Prevents multiple triggering on signals that have desired triggering level and slope occurring more than once per cycle.

GENERAL

WEIGHT: Net, 3 lb (1.4 kg); shipping 6 lb (2.7 kg).
ENVIRONMENT: Same as Model 183A/B.
PRICE: HP Model 1840A, \$550.00.

MANUFACTURING DIVISION HP Colorado Springs Division
1900 Garden of the Gods Road
Colorado Springs, Colorado 80907

The capacitance of the 183A deflection structure is not exactly the same as the 180A, requiring readjustment of the plug-in's compensation circuits for optimum high-frequency response when a 180 plug-in is first installed in the 183A. (No adjustments are required when 180 Time Bases are installed in the 183A*.)

Power Supplies

Redesign of the power supplies for heavier current capability provided an opportunity to take advantage of integrated circuits, getting added performance within cost and space requirements. The low-voltage power supplies now use 'fold-back' current limiting, in which the current limit is reduced as overload increases. This protects the regulator transistors from excessive dissipation in the event of accidental short circuits during servicing. Active circuits are also protected by fast-acting crowbar circuits that shut off the power supply in the event of over-voltages.

To keep operating temperatures low with the heavier power supply output, forced air cooling was added to remove the extra heat (overall instrument power consumption with 1830A and 1840A plug-ins installed is still low, only 120 watts). A new brushless dc fan motor obtains forced air cooling without the usual sacrifice in quietness or power-line frequency range. The fan motor uses Hall-effect devices that enable magnetically-switched commutation. It is exceptionally quiet, both electrically and acoustically.

Simplified Maintenance

Of particular interest to instrument maintenance personnel, there has been a substantial reduction in the number of internal adjustments—the vertical channel from inputs to CRT needs only *two* adjustments to smooth out frequency response, and three for dc balance, as compared to the 30 to 40 required by many high frequency oscilloscopes. Printed circuit boards are easily accessible for service and calibration. Many of the boards are plug-in.

*Although fully 'upwards compatible,' the system is not 'downwards compatible' in that the 1830A and 1840A plug-ins cannot be used in the 180A or 181A mainframes.

Acknowledgments

Development of the Model 183A Oscilloscope was a team effort. Alan J. DeVilbiss designed the vertical amplifier chain and, in cooperation with David Chaffee, made substantial contributions to the design of the CRT. The new Time Base was designed by Richard McMorrow and William Mordan. Mainframe circuit design was carried out by Kent Hardage, Rolf Luscher, Mylo Muterspaugh, and Ron Hill. Product design and packaging of the mainframe and plug-ins was an effort shared jointly by Don Skarke and Lee Olmstead. 🖨

James Pettit



Joining HP in 1962 on graduating from Utah State University, Jim Pettit initially worked on the Model 1754A Four-channel plug-in for the Model 175A Oscilloscope. At the same time, he participated in the HP Honors Co-operative Program, earning his MSEE from Stanford in 1964. Jim subsequently contributed to the 140 series Oscilloscope program, designing the 1406A and 1407A

stabilized sensitive dc-coupled amplifiers among other projects. He later became project leader for the Model 183A Oscilloscope.

Jim likes to swim for exercise and, for fun, takes his four youngsters camping in the Colorado Rockies.

A Fast-Writing, High-Frequency Cathode-Ray Tube

A three-way requirement for high-frequency response, fast writing rate, and sensitivity used all that we knew about cathode-ray tube design, and more.

By David Chaffee

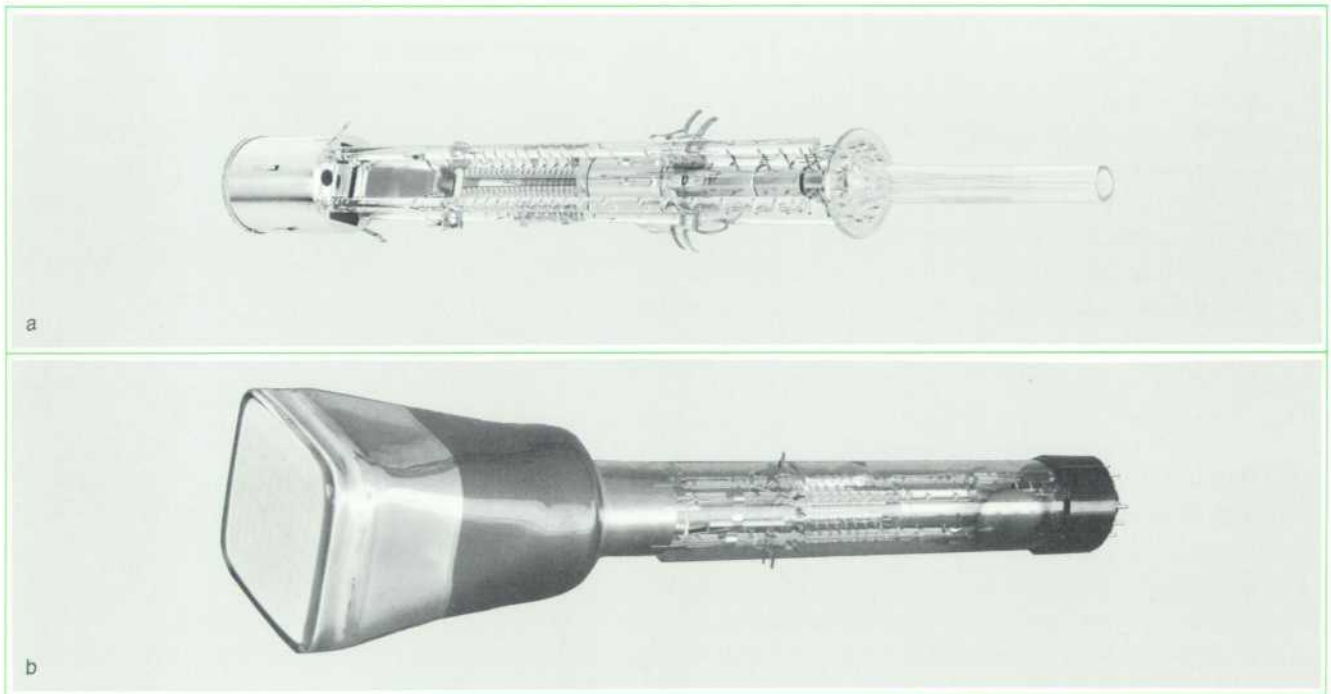

Fig. A. Electron gun and deflection plate sub-assembly of cathode-ray tube used in Model 183A Oscilloscope. **Fig. B.** Completely assembled cathode-ray tube.

TO MAKE A SENSITIVE, GENERAL-PURPOSE 250 MHz OSCILLOSCOPE FEASIBLE, a cathode-ray tube was needed with the sensitivity and spot size of the CRT in HP's Model 180A Oscilloscope but with ten times the writing rate, and three to five times the frequency response.

The groundwork for such a tube had been laid during development of the CRT for a high-performance TV waveform monitor, the Model 191A TV Oscilloscope.¹

¹R. Monnier and R. Reiser, 'A New TV Waveform Oscilloscope for Precision Measurements of Video Test Signals,' *Hewlett-Packard Journal*, Vol. 17, No. 6, Feb., 1966.

This instrument required a CRT that could write a readable trace during fast sweeps even though the sweep repetition rate may be low. To meet this requirement, without resorting to very high accelerating voltages and resultant x-ray radiation, William Kruger of the Hewlett-Packard Laboratories in Palo Alto worked out the electron optics for a large diameter electron beam. In this design, the electron beam is twice the diameter of the usual CRT until it leaves the deflection region. It is then converged towards normal spot size at the phosphor

surface. This obtains a significant increase in current density at the phosphor, resulting in a brighter spot that has a faster writing rate. The electron optics for the 183A CRT were patterned after this tube.

Computer Optimized

To get maximum performance from the new CRT, a computer was used to examine the complex relationships between physical parameters—like electrode spacing, aperture size, available voltages—and performance parameters like spot size, beam power, space charge defocusing, deflection factors, and so on. The computer program varied each physical parameter and calculated the effect of the variation on the performance parameters, ultimately converging on a design where all factors were optimized. A very fast writing rate (4 cm/ns) is obtained with only 20 kV overall accelerating voltage.

Sensitivity vs High-frequency Response

Normally, there is a trade-off between sensitivity and high-frequency response in a cathode-ray tube. Sensitivity requires long deflection electrodes to increase the time that an electron is exposed to the deflection field, but an increase in electron transit time lowers the frequency response. This limitation has been bypassed in some CRT designs by use of segmented deflection electrodes with appropriate signal delay from segment to segment. The electron beam is thus exposed to a deflection field that travels from segment to segment at the same speed as the electrons. This obtains the high-frequency response of a short electrode, but the sensitivity of a long one. This approach was used in the CRT for the Model 183A Oscilloscope to obtain more than 500 MHz response and vertical deflection sensitivity of 3 volts per centimeter (deflection range is 6 cm).

Of the several techniques for making traveling-wave deflection electrodes, helical electrodes were selected because they make it easy to have many short electrodes, construction is compatible with Hewlett-Packard production techniques, and the structure can be made to have a characteristic impedance matched to the driving circuits.

The helices are wound from metallic ribbon but are slightly flattened to improve the deflection field characteristics. A pair of helices are solidly mounted to the glass beading rods that hold the elements of the electron gun, and the electron beam travels between the two helices. Each turn of a helix forms a segment of the deflection electrode. Since electron transit time past any segment is only 100 picoseconds, frequency response of the CRT is greater than 500 MHz.

The pair of helical deflection electrodes form a balanced transmission line with a characteristic impedance

of 330 ohms. After assembly, performance of the vertical deflection structure of each tube is checked with a high-resolution time domain reflectometer, assuring that the structure has smooth impedance characteristics at all frequencies for which the tube could be used.

The horizontal deflection electrodes are conventional and have a sensitivity of 6 volts per centimeter and a deflection range of 10 cm.

Expansion Mesh

The deflection sensitivity of the new CRT is augmented by use of a mesh electrode, a technique used in all HP high-frequency scopes designed since 1962. This electrode is a dome-shaped fine mesh screen in the path of the electron beam where the beam leaves the deflection region. The mesh shapes the post-accelerating field so that it magnifies the deflection by a factor of 2½, reducing the required deflection voltages.

Enhanced Writing Rate

The new tube is normally supplied with P31 phosphor but P11 is optionally available. Whatever the phosphor, writing rate is enhanced by a flood gun that evenly illuminates the entire phosphor surface (this illumination delineates the black lines of the no-parallax internal graticule). The overall phosphor excitation provided by the illumination raises the threshold level of the phosphor, thus obtaining a visible trace with fewer electrons.

Acknowledgments

The design team for the 183A cathode-ray tube included Robb Beeson, John Crowinshield, Ronald Larson, Garry Hodge, and Henry Ragsdale. Alan J. DeVilbiss developed the computer program for optimizing CRT parameters. 



David Chaffee

Design experience Dave Chaffee earned with traveling-wave tubes in a college-oriented work-study program was one of many inputs in the design of the 183A CRT. Dave also developed the dual-beam CRT for the 132A Oscilloscope and worked on the expansion mesh CRT's for both the 140A and the 141A Oscilloscopes. He has been with HP since 1961, after earning BSEE and MSEE

degrees at the University of California.

As a volunteer Scout Leader, Dave rides herd on an Explorer Scout Troop. In between times, he rides herd on three small ones of his own.

A Wideband Oscilloscope Amplifier

Solid-state monolithic technology makes possible wideband amplifier design with improved response, economy of power, and ease of maintenance.

By Alan J. DeVilbiss

ALTHOUGH IT'S A GOOD INDICATOR OF OSCILLOSCOPE CAPABILITY, frequency response does not tell all—the user really wants to know how faithfully an oscilloscope can reproduce a waveform. Hence, other amplifier characteristics, like the shape of the frequency response curve, phase response, and linearity, assume equal importance.

In obtaining high-fidelity waveform reproduction, the oscilloscope designer must deal with the many frequency sensitive elements in the vertical amplifier. These are primarily parasitic reactances, unavoidable consequences of any physical structure. The approach taken in the design of the 1830A Dual-Channel Vertical Amplifier plug-in

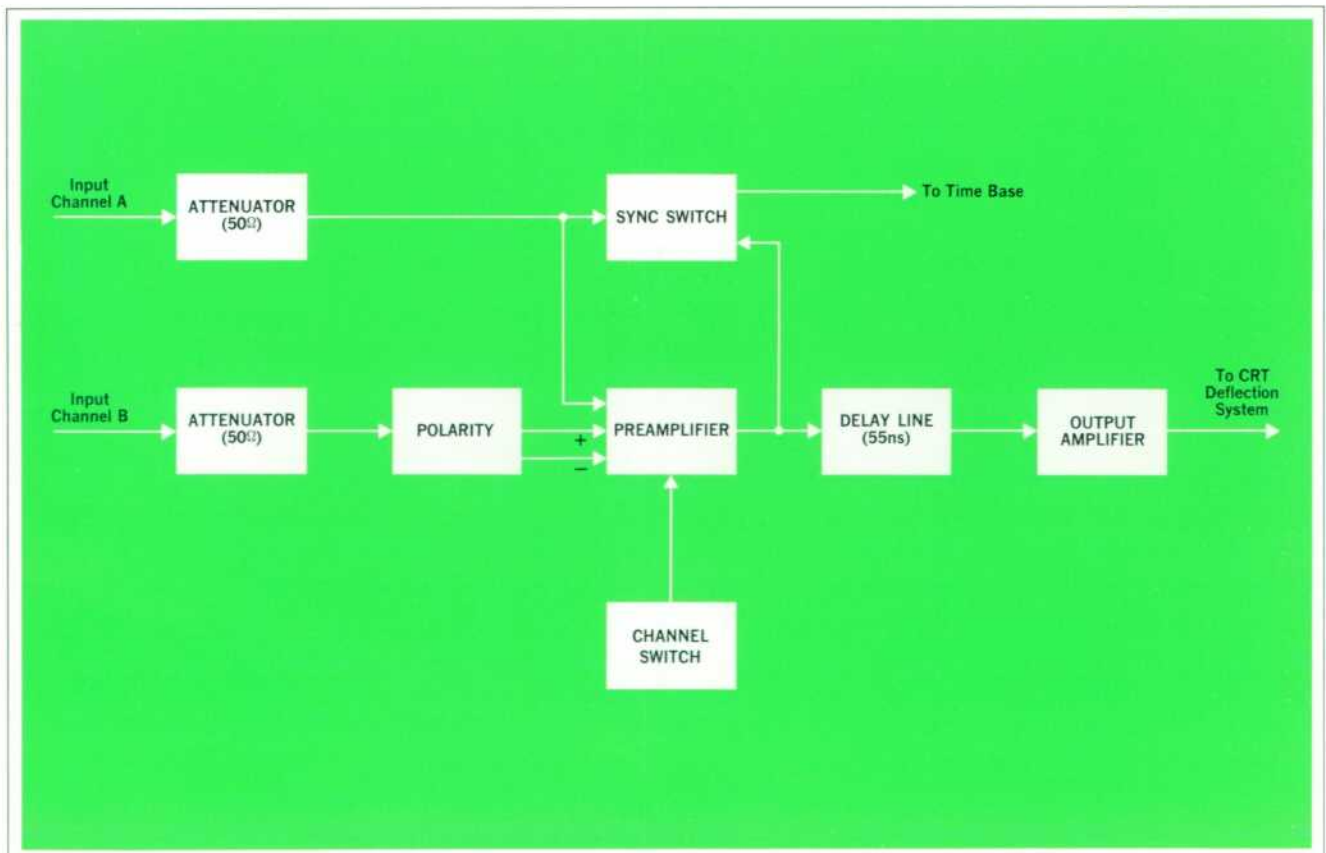

Fig. 1. Simplified block diagram of Model 1830A 250 MHz Dual Channel Vertical Amplifier.

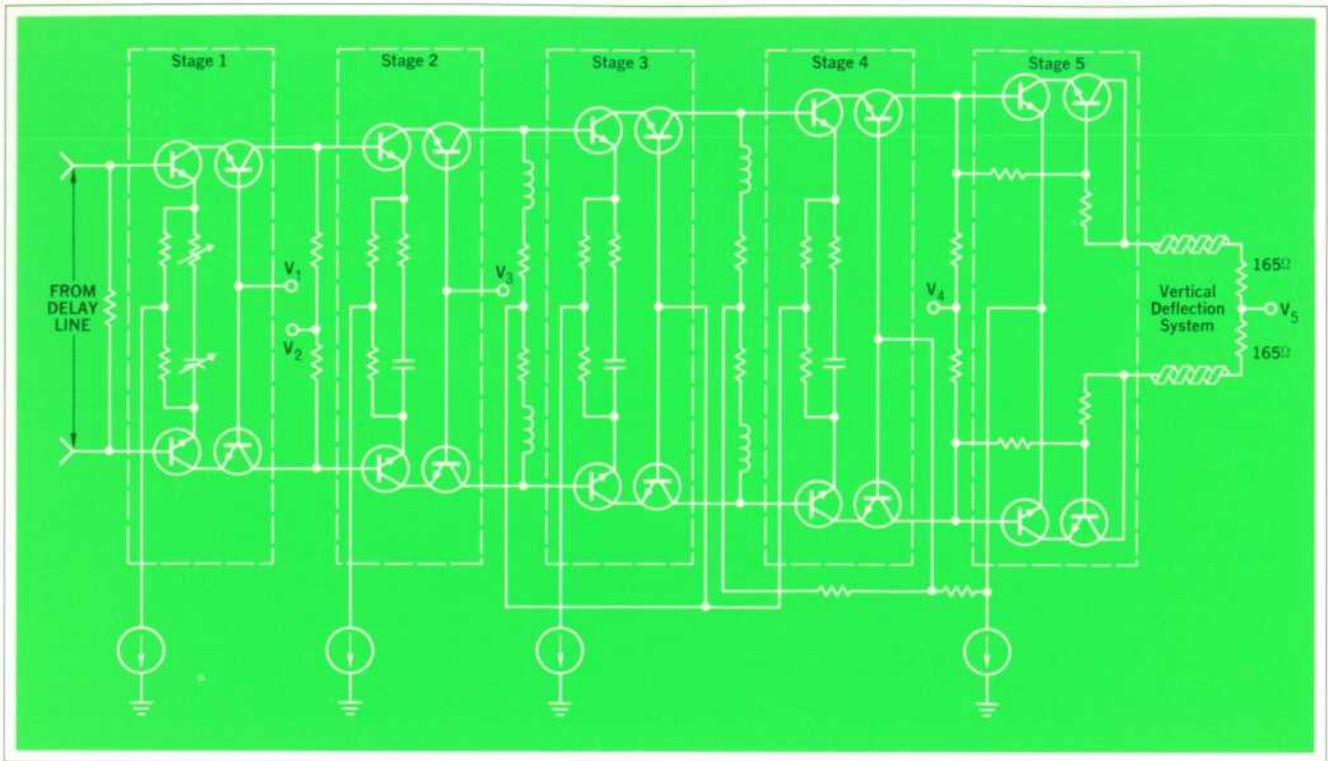

Fig. 2. Output amplifier of Model 1830A Vertical Amplifier. Only two adjustments (first stage emitter peaking) are needed to set high frequency response.

was to eliminate physical structures wherever possible, and to use recently-developed solid-state technology to minimize the remaining parasitics. The design was refined with the help of s-parameter measurement techniques plus computer-aided optimization.¹ As a result, displayed risetime of the new scope is very fast, less than 1.5 ns, while overshoot and other perturbations in response to a fast voltage step are less than 3% of step voltage.

Monolithic Transistors

Solid-state monolithic technology was one of the key factors in achieving good transient response with 250 MHz bandwidth in the 1830A Amplifier. This technology has given us transistors that have high-frequency capability over wide current ranges (see article following). These transistors are fabricated in arrays on single chips, each array having the active elements for one differential amplifier stage. Parasitic reactances are reduced substantially by the microdimensions of the signal paths within each array. Feedback networks, with their parasitic reactances, are not needed for gain stability because the transistors in each array are closely matched, being made under identical conditions.

Signal Path

The 1830A Dual-Channel Vertical Amplifier is outlined in the simplified block diagram of Fig. 1. Input signals go directly to the 50Ω range (VOLTS/DIV) attenuators, which give deflection factors of 10mV/div to 1V/div in seven steps. The absence of range switching within the amplifier ensures constant amplifier performance on all ranges.

Sync take-off follows either the Channel A attenuator or the preamplifier output (COMP). Channel A sync ties the time base to a single signal but COMP (composite) sync allows syncing on whatever signal is in the display channel.

The preamplifier has two differential amplifiers with separate inputs and a common output. Switches at the input (not shown) allow disconnect of the signal in either channel. Diode switches within the preamplifier gate the signals for display of each on alternate sweeps, or both during the same sweep in a time-shared (CHOP) mode. The algebraic sum of the signals can also be displayed, with the signal in Channel B straight up (A+B) or inverted (A-B).

The preamp drives a delay line only 55ns long, about

¹Alan J. DeVilbiss, "Computer Techniques in High Frequency Circuit Design," WESCON 1969.

one-third the delay of earlier scopes. The shorter delay, made possible by fast CRT unblanking and the fast sweep start of the Model 1840A Time Base, means less high-frequency loss, and less space is needed for the high-quality 150-ohm, twin-conductor coaxial delay line.

Output Amplifier

The output amplifier illustrates how monolithic transistors are used to good advantage. A diagram is shown in Fig. 2. Each of the first four stages uses a four-transistor array in a differential cascode circuit—differential to amplify the push-pull signals needed for driving the CRT, cascode to minimize high-frequency losses from collector-base Miller capacitance.

Direct connections between transistor elements are made by metallization on the monolithic arrays, reducing signal paths to the bare minimum. External connections are made on strip-line circuits formed on the printed-circuit board.

High frequency compensation is obtained by reducing emitter degeneration at high frequencies with emitter-to-emitter RC networks. Only the first stage has an adjustable network, however, *the only two compensating adjustments needed to adjust the amplifier's high frequency*

response (one other adjustment balances dc response and two more balance out range switching offset). This contrasts sharply with the 30 to 40 adjustments required in earlier high-frequency scopes. High-frequency losses in the delay line are offset by fixed inductive compensation in the collector loads of the second and third stages.

The fifth stage uses current feedback to obtain a 330-ohm source impedance for driving the CRT deflection electrodes. As explained in the preceding article, the 183A CRT uses a distributed deflection structure that appears to the amplifier as a resistive rather than a capacitive load. With this approach, response speed is not limited by available current, as it is in conventional oscilloscopes,* but by the characteristics of the overall amplifier design.

In view of the fact that higher transistor V_{ce0} is usually obtained at the expense of f_T , the fifth stage circuit configuration has a further virtue in its division of the output voltage among the four transistors, allowing a lower V_{ce0} to be specified.

Further economies in power are had by supplying collector current to stage 2 from the emitters of stage 4 and

*Response speed of conventional oscilloscopes is limited by the current available to charge the deflection electrode capacitance. Supplying large amounts of current to slew the capacitance voltage quickly speeds response, but this design approach is not likely to result in a compact, lightweight, cool-running instrument.

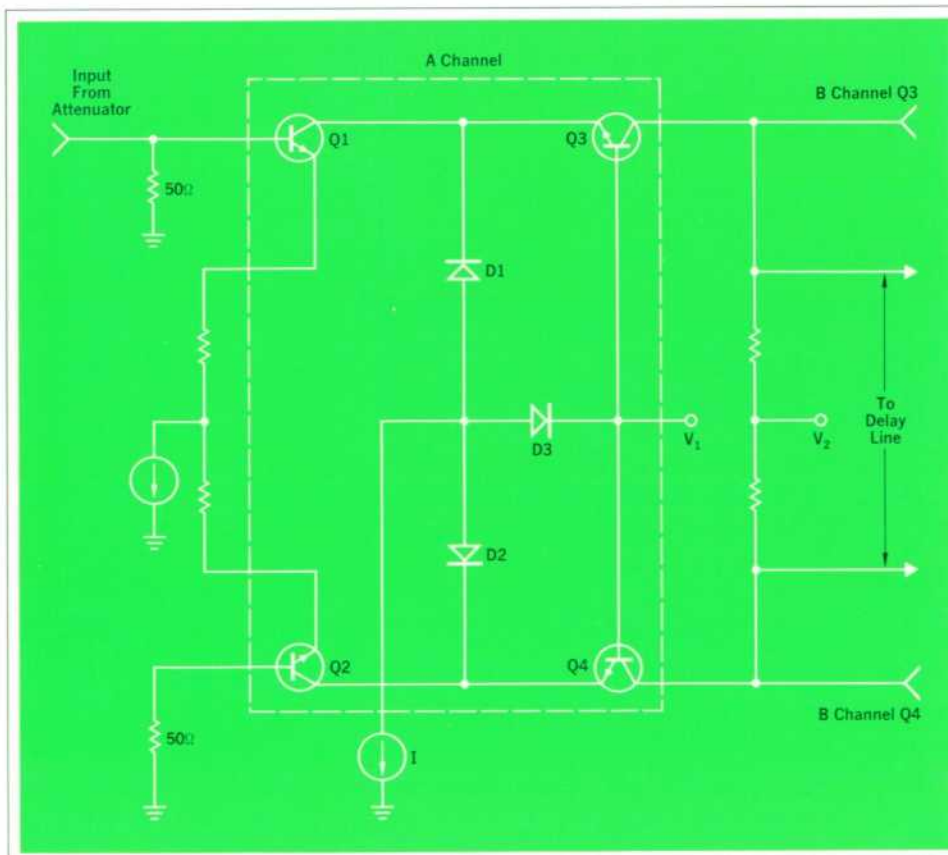

Fig. 3. Preamplifier circuit for Channel A. Eight transistors and six diodes for both preamplifier channels are on single semiconductor chip.

collector current to stage 3 from the emitters of stage 5, gaining a substantial reduction in overall current consumption. This works because the emitters look like constant-voltage sources to the collectors while the collectors look like constant-current sources to the emitters. It also provides a means of biasing stage 4 so stage 5 will never go into saturation, assuring quick recovery from overloads.

Vernier Gain Without Parasitics

A significant reduction in parasitic reactances was achieved in the design of the vernier gain and channel switching functions. Rather than bring the signal to a variable attenuator, with its unavoidable bulk capacitance and series lead inductance, the signal is attenuated by diodes fabricated on the same chip as the preamplifier transistors.

A circuit diagram of the Channel A preamplifier circuit is shown in Fig. 3. Signal attenuation can be varied over a 2.5:1 range by adjustable current source I, which forward biases diodes D1-D2. The diodes withdraw some of the emitter bias current passing to transistors Q3-Q4, raising the differential common-base input impedance of Q3-Q4 at the same time the diode shunting impedance is reduced. Signal attenuation is thus controlled by a dc bias current removed from the signal path, a current that can easily be supplied through front-panel controls.

For this attenuator to work properly, diode characteristics must match transistor input characteristics. This matching is realized by the identical processing history, physical proximity, and close thermal tracking of devices fabricated on the same chip, as these are.

Channel Switching

Diodes D1-D2 also gate the signals for channel switching. When diode current I exceeds the transistor bias current, transistors Q3-Q4 are cut off, D3 is forward-biased, and all signal current is shunted through diodes D1-D2. A simple and effective channel switch is thus realized without the introduction of additional series or shunt parasitic elements. Because the preamplifiers of both channels, formed on the same semiconductor chip, are connected to a common load, the single output channel can be time-shared by the two inputs (the Channel B preamplifier is identical to Channel A except the signal input can be switched to transistor Q2 to invert the output).

Channel switching is controlled by a flip-flop that supplies diode switching currents (vernier gain control currents are added to the flip-flop outputs). The flip-flop is

triggered by the sweep hold-off signal from the Time Base plug-in to display each signal on alternate traces, or by a free-running multivibrator to display both signals on the same sweep by switching between channels at a 250 kHz rate (switching transitions are so fast there is no need to blank the CRT during the transitions).

Sweep start cannot be triggered by the channel switching signal when internal triggering is used, because the switching signal is gated off when the Time Base is not sweeping. The switching signal continues to be generated while its output is gated off, however, so there is little likelihood that the switching signal will synchronize with the sweep. Channel switching occurs randomly on successive sweeps so the traces do not have the segmented appearance that chopped traces do when channel switching locks in with the sweep.

Acknowledgments

The author is deeply indebted to Floyd Siegel* (originator of the 183A project) and to many others at the HP Colorado Springs Division for encouragement and assistance, and to Merrill Brooksby and James Grace of the HP Santa Clara Division for designing and manufacturing the transistors needed for the 1830A. 

*Now Engineering Manager of HP's San Diego Division.

Alan J. DeVilbiss



While exploring the capabilities of HP's Model 1300A Large-Screen Display, Al DeVilbiss designed a gargantuan deflection amplifier that could partially scan the 1300A's CRT at 250MHz, albeit with much heat and fury. This feat earned him a key position on the Model 183A design team, where he succeeded in getting 250MHz performance without the heat and fury.

Al earned his BSEE from Louisiana Polytechnic University in 1960 and an MSEE from the California Institute of Technology a year later. He worked on spacecraft system sequencers, counters, and computers after leaving school but a desire to do circuit design led him to the HP Colorado Springs Division in 1965.

For fun, Al likes to ski when there's snow on the ground but when there isn't, he enjoys wheeling his TR4 through autocross, hill climb, and other sports car events.

Monolithic Transistor Arrays for High-Frequency Applications

By Merrill Brooksby and Richard D. Pering

ANY ENGINEER DESIGNING HIGH-FREQUENCY CIRCUITS inevitably comes up against the limitations imposed by distributed capacitance and inductance. Common practice has been to absorb these parasitic reactances into a transmission-line structure, as in distributed amplifiers and strip-line circuits

Although this technique achieves significantly broader bandwidths, it is not a panacea. Unavoidable differences in capacitance and inductance between supposedly identical components require addition of adjustable compensating reactances, which not only increases the reactance already there, but which often turns circuit alignment into a nightmare.

Monolithic solid-state technology provides the best answer yet—it reduces distributed inductance and capacitance to levels far below those achieved by any other technique. Signal paths only fractions of an inch long, for very low inductance, and conductors only thousandths of an inch wide, for vanishingly small capacitance, make possible gain-bandwidth products which are unobtainable with discrete components. Using this technology, new transistors have been developed in the solid-state laboratory of Hewlett-Packard's Santa Clara Division, transistors that have both the high frequency capability and the high current capability needed in Hewlett-Packard's broad range of instruments.

Because monolithic technology places all bonding pads on the top side of the substrate, the transistor chip can be solidly mounted to a heat sink for good heat dissipation. Making shallower diffusions to improve f_T actually reduces collector-to-ground capacitance, improving high-frequency performance while retaining high power capability. Each transistor shown in the array of Fig. 1 has

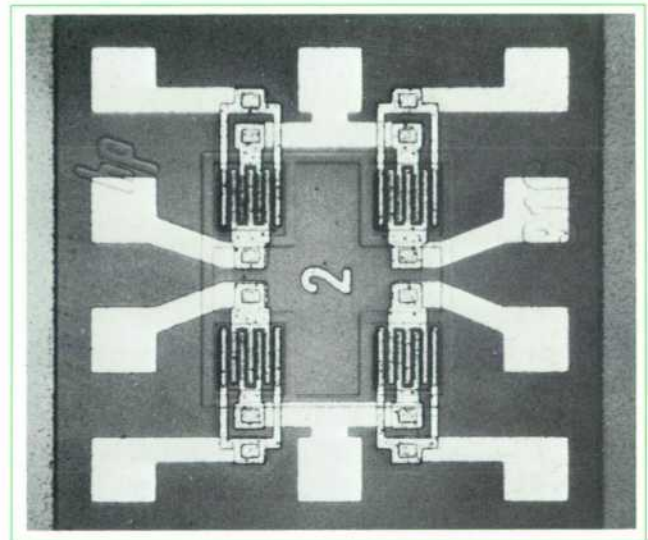

Fig. 1. Typical four-transistor monolithic array. Direct connections between transistor elements are made by metallization pattern.

approximately 0.6 pF between collector and heat sink. Compare this with the 20 to 200 pF collector-to-ground capacitance that results when a discrete transistor is mounted to a heat sink.

An isolating wall around each device in these monolithic arrays allows the base and emitter bonding pads to extend beyond the collector area and be placed over the substrate. Collector-to-base capacitance, and hence collector-to-base feedback, is reduced. As a result, these transistors are unconditionally stable throughout the frequency range plotted in Fig. 2. Also, f_T , which extends well into the microwave region, does not fall off rapidly at high currents.

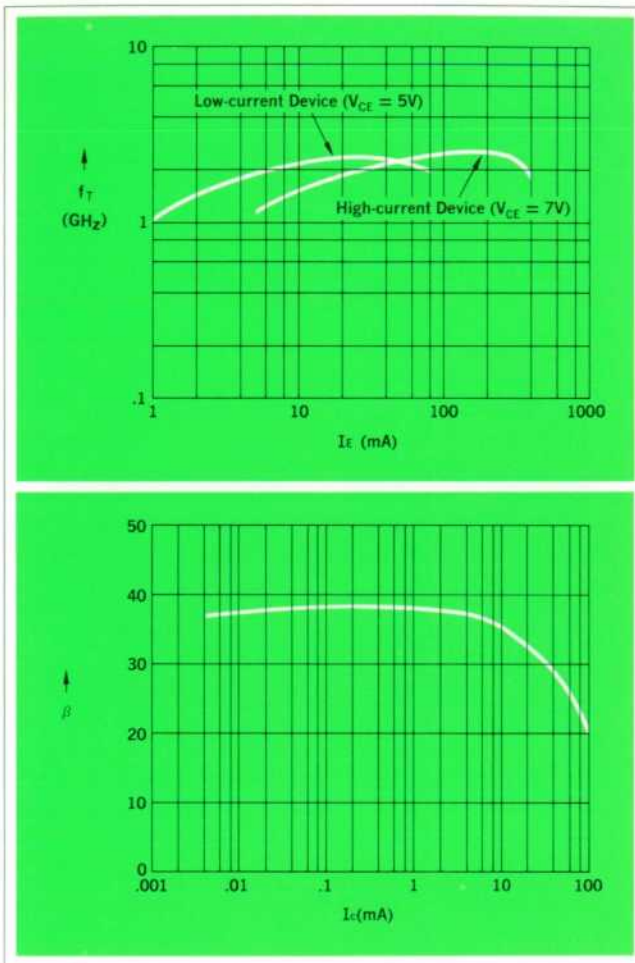

Fig. 2. f_T vs I_E for two types of transistors made by monolithic technology. Note reasonable flatness of curves over wide current range.

Fig. 3. DC beta vs I_C for monolithic transistor. Beta remains constant throughout wide current range.

In contrast with the characteristics of currently available off-the-shelf devices, dc beta of these transistors does not fall off at low currents (Fig. 3). This is important in switching applications as high gain can be maintained throughout the switching cycle. Emitter-coupled logic gates with less than 0.5 ns propagation delay have been made with these devices.

Since the technique allows several transistors to be placed on one substrate, amplifiers using these arrays have excellent dc stability. Particularly important for balanced amplifiers like those used in the 183A Oscilloscope, the transistors are in intimate thermal contact with one another and large thermal differences do not develop.

The transistors in an array are also well-matched with respect to beta, f_T , and other parameters since they are formed under identical processing conditions.

Besides serving as broadband linear amplifiers for the new Model 183A Oscilloscope, these devices are being used in stable 1-GHz amplifiers that have 1/2 watt output power and in high-speed logic circuits.

Acknowledgments

James Grace and Max Schuller developed the manufacturing processes for the transistor arrays. 

Merrill Brooksby



Merrill Brooksby joined HP in 1959, going right to work on Frequency and Time Instruments where he has been ever since. He first worked on the Model 5275A 100MHz Time Interval Counter, then several of the 5245A Counter plug-ins, and, recently, the 5360A Computing Counter.

Merrill was one of the early progenitors of IC's at HP and helped in outfitting HP's first IC lab. He is now

Engineering Section Manager of high-frequency counter development at HP's Santa Clara Division.

Merrill earned his BSEE degree at Brigham Young University, over a protracted period that included interruptions for military service and for church missionary service, and an MSEE degree from Stanford University (1962). He has held a private pilot's license for 20 years.

Richard D. Pering



Rick Pering started working summers with HP in 1958, and then, after getting his BSEE degree from Stanford University, joined the company full time in 1962. Initially he worked on the 5254A and 5255A Frequency Converter plug-ins for the 5245-series Counters, and later became group leader on the 5256A 8-18GHz Frequency Converter plug-in.

Rick is building a bona fide pipe organ into his home with parts assembled from funeral homes, retired church organs, and other sources. It includes a pneumatic programmer that uses punched paper tape like that used in player pianos. On the other hand, Rick's wife, an MSCh, spends her days at Ames Research Laboratories analyzing moon dust.

A Fast Time Base for a High-Frequency Oscilloscope

A fresh approach to time base circuits was needed to get fast linear sweeps and stable triggering at high frequencies.

By William Mordan

THE TIME BASE OF A REAL TIME OSCILLOSCOPE has three functions: recognize a trigger, unblank the cathode ray tube, and generate a sweep. These requirements appear simple enough but are not so easy to fulfill when scope performance calls for 10 ns/div sweep speeds and triggering on any frequency up to 500 MHz—with no compromise of user convenience.

A hard look at these requirements has led to a new time base design, one that is significantly different from traditional concepts. The entire sync amplifier is now part of the time base, trigger and gate generators are no longer separately identifiable, the familiar Miller run-down sweep generator has been replaced, and a new automatic hold-off circuit has been added.

The new Time Base (Hewlett-Packard Model 1840A) needs only 50 mV p-p to trigger solidly on signal frequencies up to 500 MHz and beyond, and for frequencies up to 250 MHz, only 20 mV p-p is needed. Common high-frequency sync problems, like double triggering, have been all but eliminated.

With the X10 magnifier in the mainframe, sweep time can be as fast as 1 ns/cm, with 5% linearity (without the magnifier, linearity is better than 3%). Sweep recovery time is short, allowing sweep repetition rates to be as high as 2 MHz for extremely bright display of very fast sweeps. Full flexibility is retained—the time base has repetitive or single sweep capability, basic sweep times from 10 ns/div to 0.1 s/div, triggering on positive or negative slopes, automatic triggering for baseline display in the absence of a triggering signal, and variable hold-off that allows selection of one particular pulse within a repetitive group of pulses for triggering. For single-sweep operation, the sweep can be armed either manually or by an electrical trigger applied through a rear-panel connector.

Sync Amplifier

Placing the sync amplifier in the Time Base makes possible the high sensitivity for external sync inputs. Internal sync signals are tapped off vertical channel A immediately following the input attenuator (SYNC CH A) or following channel switching (SYNC COMP).

A block diagram of the sync input channel is shown in Fig. 1. In this system, the 'sync comparator' adds a dc offset to the input waveform. The dc offset can be varied by the 'Trigger Level' control to place the sweep trigger level at any point on the waveform. The logarithmic characteristic of the 'Trigger Level' control circuit allows sync selection over a wide amplitude range equivalent to three screen diameters, but with high resolution around the zero level.

The sync amplifier uses two cascaded sets of monolithic transistor quads in a circuit that has a frequency response that rolls off smoothly above 100 MHz. The smooth, monotonic roll-off assures that the amplifier does not add any overshoot to fast waveform transitions, overshoots that could cause trigger level and slope criteria to be met more than once during a waveform period, a troublesome source of multiple triggering.

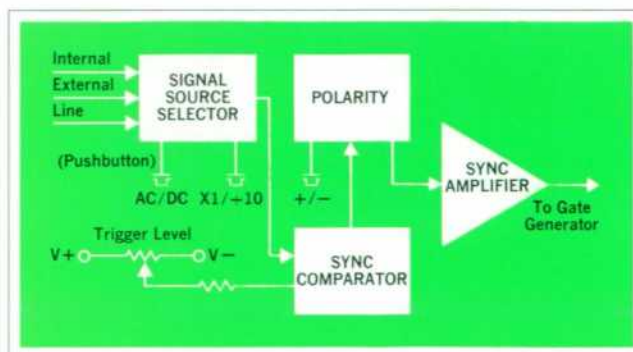

Fig. 1. Sync input conditioning circuits.

Double-triggering

In laboratory-grade oscilloscopes, a hold-off circuit prevents a sweep from being triggered, following completion of the previous sweep, until the circuits have recovered completely. If a trigger comes along while the hold-off circuit is resetting, however, the sweep may trigger, but at a different level, and the sweep starts at a different point on the waveform. The result is apparent horizontal shifting of the waveform, often causing the scope to display what appears to be two phase-displaced waveforms. This is referred to as 'double-triggering'.

To alleviate this problem, high-frequency oscilloscopes have had a hold-off vernier adjustment, labeled 'High-frequency stability', to allow change of reset time so it does not occur at the same time as a trigger. At high frequencies, this adjustment is often troublesome. A new triggering system for the 1840A Time Base narrows the time when double-triggering could occur.

A diagram of the new triggering system is shown in Fig. 2. Tunnel diode D1 is the threshold recognizer and the gate generator, and tunnel diode D2 is the rearming control.

In the circuit's 'armed' state, D1 is in its low-voltage (off) state. A positive-going signal at the base of transistor Q1 starts the sweep when the current drawn by Q1 through D1 reaches the threshold level, I_p . This turns on D1. During the resulting sweep, both D1 and D2 are maintained in the 'on' state by current drawn by the 'Control Reset' circuit.

Control Reset turns off at the end of the sweep, letting diodes D1 and D2 drop back to the 'off' state. At the end of the hold-off period, Control Reset is turned back on, but the current it then supplies to D2 is not sufficient to turn on D2, unless Q2 supplies enough additional current.

In the absence of a trigger signal, the steady-state current through Q2 is sufficient to turn on D2 as soon as Control Reset turns back on. If the trigger signal at Q1 is above the trigger threshold level, however, the current through Q2 is not enough, and D2 remains 'off' until the trigger drops below the threshold level. Furthermore, as long as D2 is 'off', there is insufficient current through R to allow the current drawn by Q1 to trigger D1. Thus, D1 cannot be triggered unless D2 is 'on', but D2 cannot be turned on while a triggering signal is present.

This system reduces the likelihood of double triggering because D2 turns on in only 0.3 nanoseconds. Double triggering could occur only during this time.

Automatic Hold-off

Double triggering within a time span of 0.3 ns is hardly visible in most applications, but at sweep times of 10 ns/cm or less it could be. A new automatic holdoff circuit has been added to prevent this possibility. The circuit examines the time interval between arming and triggering of the sweep, and adjusts hold-off to keep this time interval from going to zero.

A block diagram is shown in Fig. 3. The output of the And gate is a pulse train with pulse width proportional to the time between arming and triggering. Pulses of standard width but of opposite polarity are triggered by the gate waveform. Both pulse trains are applied to capacitor C and if the width of the pulses in both trains are the same, no charge is added to capacitor C. If there is a difference in pulse width, a charge builds up on capacitor C and the resulting voltage changes the current that determines hold-off time. Hold-off time is thus adjusted automatically to maintain a fixed time difference between arming time and triggering time.

Sweep Generator

Fast, linear sweeps are generated by the circuit shown in Fig. 4. It consists simply of a constant-current source charging a capacitor. This generator does not depend on active device parameters, as does the operational amplifier commonly used in Miller integrator sweep generators, and it requires no high-frequency adjustments to get linearity at high sweep speeds. It also simplifies range switching arrangements because one end of the sweep capacitor can be tied to ground.

Between sweeps, the sweep capacitor voltage is held at ground potential by field-effect transistor Q3. The sweep starts when the gate pulse turns off Q3 (and Q2) by way of Q1.

At the end of a sweep, bi-polar transistor Q4 discharges the sweep capacitor rapidly. Q4 is turned off half way through the hold-off period to allow time for removal of any charge remaining in its base region. Q3 assures precise return of the capacitor voltage to zero. The fast sweep recovery is shown in Fig. 5.

Though simple, this sweep generator is accurate and linear. However, to maintain accuracy and linearity any load applied to the circuit must be greater than 10^7 ohms and load capacitance should not change more than 1pF during the 0–10 V sweep ramp. A 'sweep readout' isolating amplifier that meets these requirements is shown in Fig. 6. Here, high frequencies pass through stages 1 and 2, with positive high-frequency feedback through capacitor C1 to maintain a high-impedance input for

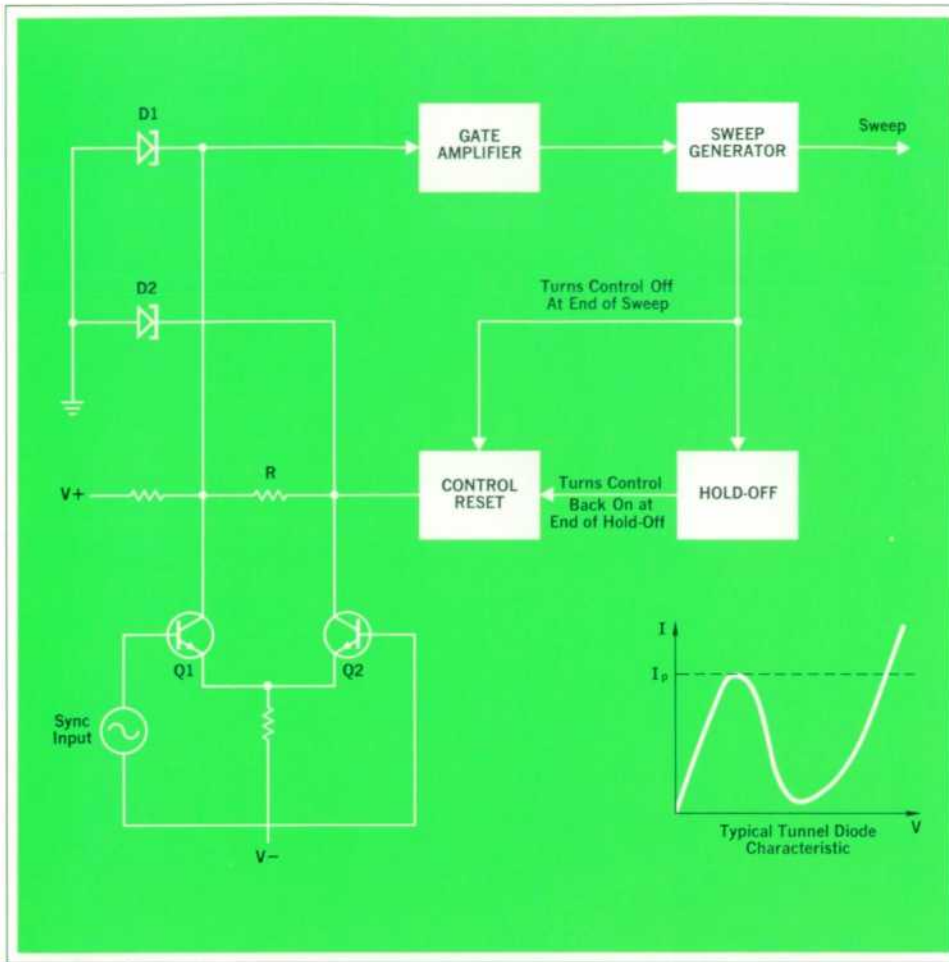

Fig. 2. Sweep trigger and gate generator functions are combined in tunnel diode D1. D2, arming control, cannot reset during time that instantaneous amplitude of sync signal exceeds trigger level (see text).

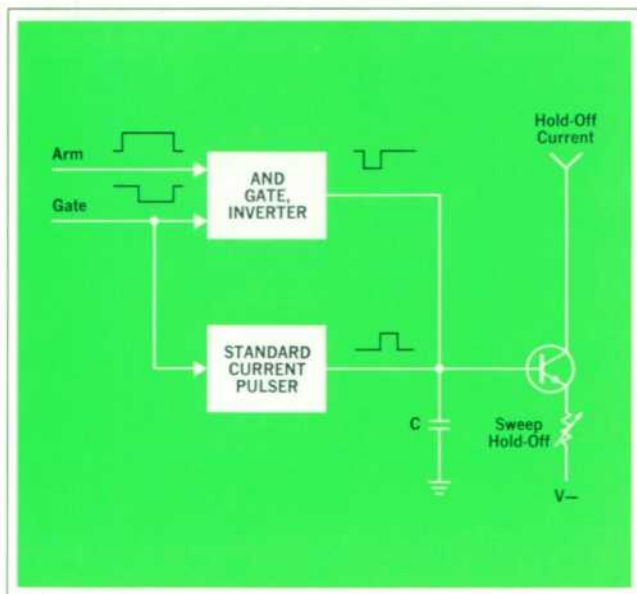

Fig. 3. Circuit automatically adjusts sweep hold-off to maintain constant time interval between arm (reset) and gate (trigger) signals.

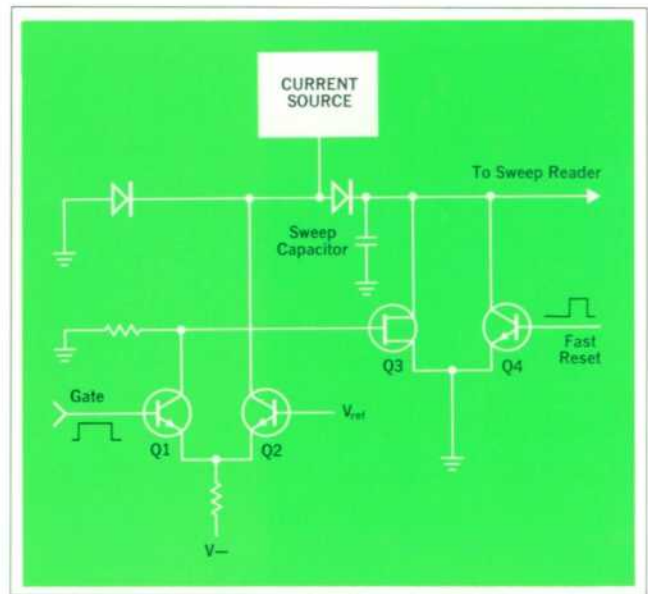

Fig. 4. Sweep generator uses constant-current source to charge sweep capacitor linearly.

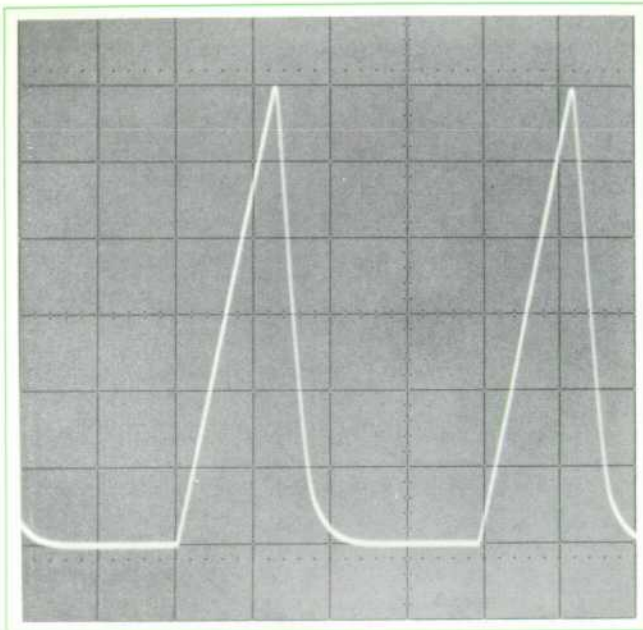

Fig. 5. Oscilloscope of sweep waveform shows linearity and fast recovery of new sweep generator operating on 10 ns/div range (display sweep time: 100 ns/div). Sweep generator recovers completely in 100 ns, is operating here at repetition rate faster than 2 MHz.

high frequency components of the sweep signal.

Low frequencies pass through stages 3 and 2, with negative feedback through R1. Capacitor C2 rolls off the frequency response of the low-frequency path. The high output impedance of stage 3 prevents loading of the high-frequency signals. By transferring high and low frequencies through separate paths, each path can be optimized for its frequency range, and no adjustments for high-frequency compensation nor for dc offset are required.

Acknowledgments

Design effort was shared by Richard McMorrow (Project Leader) and the author. Product design was by Lee Olmstead. Much help was provided by an analysis of trigger stability performed by William Farnbach.¹

¹R. Morrow and W. Farnbach, "A Novel Approach to High Frequency Trigger Circuit Design," WESCON 1969.

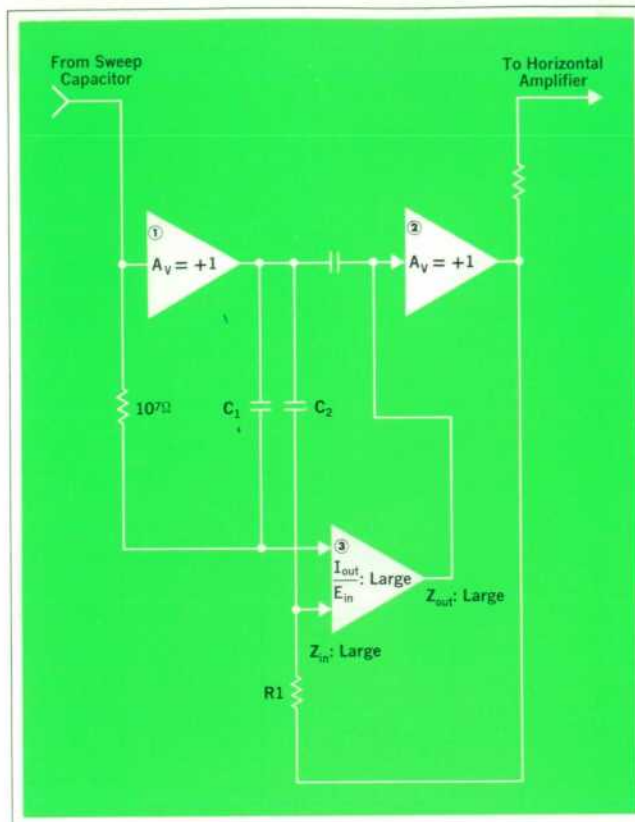

Fig. 6. Sweep readout amplifier has constant high input impedance and linearity over 0-10V range.

William J. Mordan



While earning his BSEE degree at the University of Wisconsin, Bill Mordan worked summers at HP and then joined the company full time in 1966. Initially he worked on the 180A Oscilloscope and related test equipment and then on the 1802A 100MHz Amplifier plug-in for the 180A. Since then, he has been concerned with the Model 1840A Time Base circuits.

In his spare time, Bill designs hi-fi components.