

HEWLETT-PACKARD JOURNAL

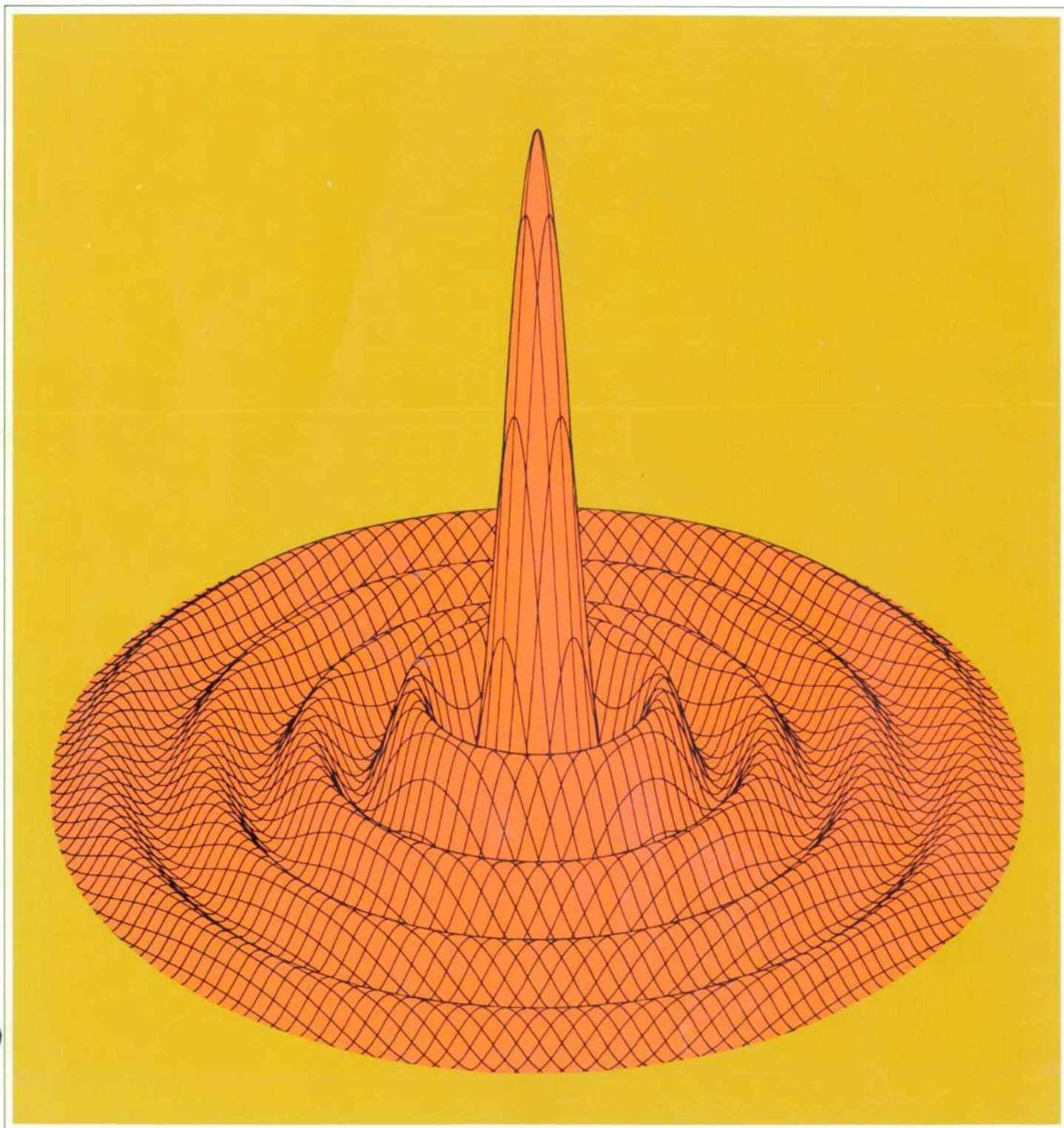

SEPTEMBER 1969

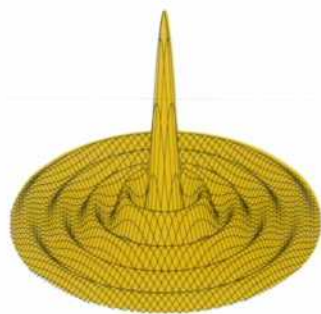

Graphical Output for the Computing Calculator

An X-Y plotter, designed to take the calculator output, draws graphs of solutions to complex problems. It can make Smith Charts, polar, semilog and log-log plots.

By Robert W. Colpitts, Dan Allen and Tom Vos

A COMPUTING CALCULATOR-PLOTTER COMBINATION is a powerful tool for evaluating solutions to engineering and scientific problems. Graphical solutions of problems such as statistical distribution analysis and curve fitting are easier to interpret than tables of numbers. Other typical problems for which a graphical solution is invaluable include exponential smoothing for economic forecasting, analysis of solutions of differential equations in fluid dynamics, heat transfer and electrical network response.

Fast conversion of computer calculations into readable graphs is possible with the new HP Model 9125A X-Y Plotter, Fig. 1. Designed for use with the HP Model 9100A Computing Calculator,¹ the plotter automatically makes permanent graphs of functions solved by the calculator with greater precision and speed than hand plotting.

Functions plotted by the calculator-plotter combination are usually incremental problems in which the independent variable is incremented in small steps. The calculator computes the value of the dependent variable for each value of the independent variable and places the two values (scaled as necessary) in its X and Y reg-

isters. The recorder is then commanded to move to the coordinate point and plot it. The calculator then increments the independent variable and computes the next coordinate point while the plotter is plotting the last point.

Cover: *Isometric projection of the function $J_0^2(r)$, computed by the 9100A Computing Calculator and plotted simultaneously by the 9125A plotter. Height of the surface shows the light intensity in the diffraction pattern of a circular annulus. Lines of constant x and y were drawn at intervals of one-half. To enhance the appearance, hidden lines were blanked by manually lifting the pen. Edges of the folds were added later.*

In this Issue: *Graphical Output for the Computing Calculator; page 2. High-Resolution Time-Domain Reflectometry with a Portable 30-lb Instrument; page 8. Precision DC Current Sources; page 15.*

For continuous function plotting, the 9125A automatically draws a straight line from one point to the next producing a smooth, continuous curve. A point plotting mode is available for problems requiring plotting of discrete points.

Plot Commands

Plots can be made either manually, using the calculator keyboard, or automatically using execution of stored program steps.

The Model 9125A Plotter responds to two control instructions already on the calculator (FMT) (\downarrow) and

Plots of continuous functions, with straight line interpolation between data points, are most conveniently achieved with an iterative program loop that contains the plot instruction (FMT) (\downarrow). The automatic pen control circuit allows the pen to move to the data point before dropping, when (FMT) (\downarrow) is given for the first time. The (FMT) (\uparrow) and (FMT) (\downarrow) instruction pair on the calculator keyboard gives the plotter the capability of plotting continuous lines, points or dashed lines.

When the plot instruction is generated from calculator program execution (rather than keyboard), the plotter automatically returns a CONTINUE signal to the calculator as soon as the new X, Y data have been received. Thus the calculator is freed to compute new data while the previously computed data are being plotted.

If a new plot command is received while the plotter is busy, execution and data transfer are delayed until the previous point has been plotted.

Control Logic

As shown in the block diagram, Fig. 3, digital information from the calculator is fed to the digital control interface. Here the plot commands are decoded and the pen instructed to move accordingly.

Digital data is presented to the 15-bit BCD horizontal (X) and vertical (Y) digital-to-analog converter (DAC). The outputs of the DAC's are simultaneously fed to two identical analog channels, each containing a low-pass filter and the pen position servomechanism.

Straight Line Generation

The pen draws a straight line as it moves from the old to the new data point because:

- The new analog position signals are applied simultaneously to both channels.
- Each analog channel is linear.
- The unit step responses of the X and Y analog channels are essentially identical, and free from overshoot.

Just prior to a plot command, the X and Y DAC storage registers contain previously transferred digital data, and the DAC's are generating analog output signals that determine the present steady state pen position X_1 , Y_1 . When a plot command is received, the control logic gates new information from the calculator display regis-

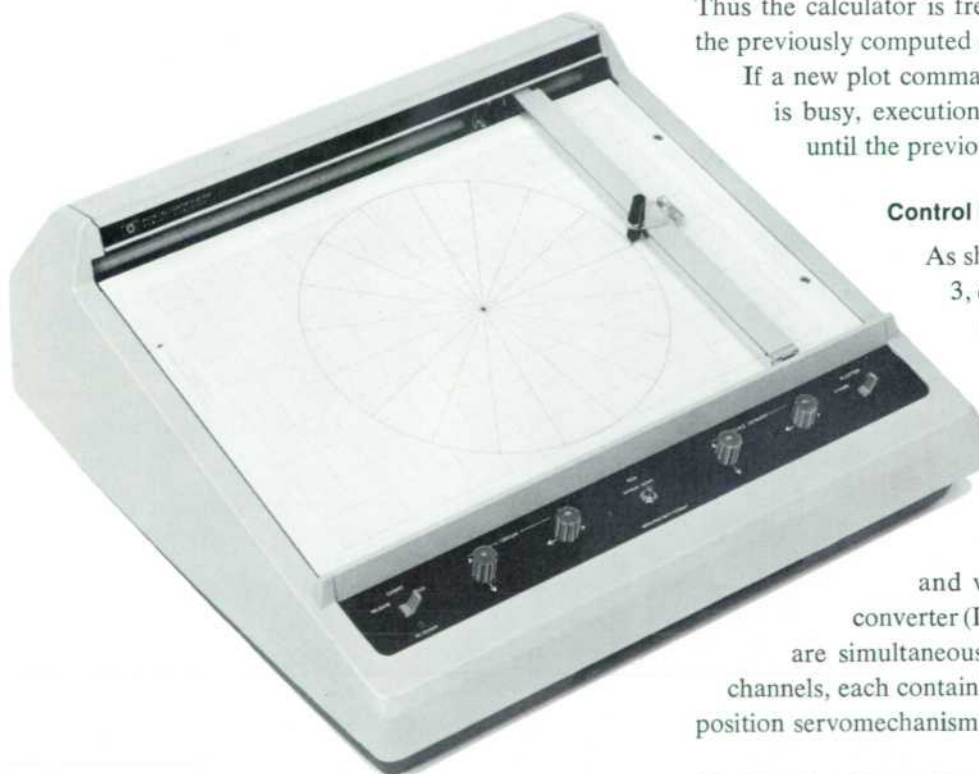

Fig. 1. This Model 9125A X-Y Plotter automatically plots solutions to problems solved by the HP Model 9100A Computing Calculator. Manual operation is also possible to transfer data points from the calculator to the plotter directly.

(FMT) (\uparrow) as outlined on the self-contained instruction card, reproduced in Fig. 2.

Operation of the plotter is simple: the data to be plotted is entered in the X and Y calculator display registers and then the appropriate plotter control instruction is given. Any normalizing or translation of data required to accommodate various graph paper formats and scales is easily handled by the calculator.

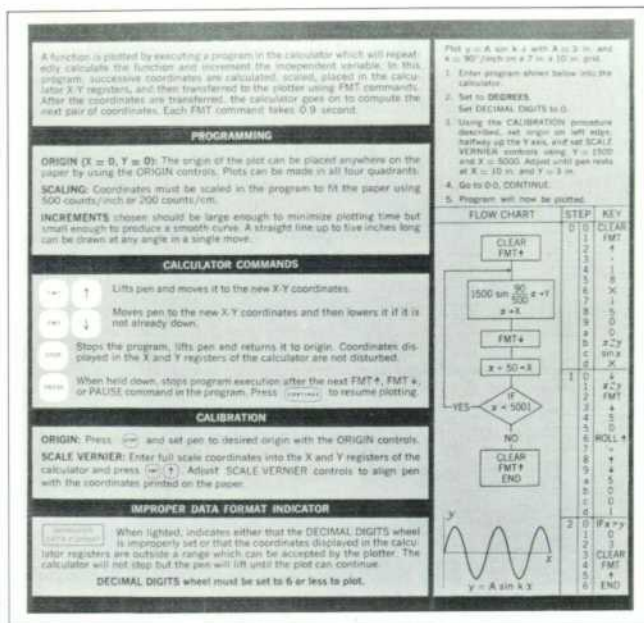

Fig. 2. Essential instructions for operation of the Model 9125A X-Y Plotter are contained on this pull-out card.

ters to the DAC storage registers simultaneously, so that the DAC outputs jump to new levels, directing the pen to the next steady state position X_2 , Y_2 . Provided each analog channel is linear (that is, the displacement output is related to the electrical input by a linear differential equation with constant coefficients), the output position responses, $x(t)$ and $y(t)$, to the step changing inputs will be of the form:

$$x(t) = X_1 + (X_2 - X_1) Hx(t) \quad (1)$$

$$y(t) = Y_1 + (Y_2 - Y_1) Hy(t) \quad (2)$$

where $Hx(t)$ and $Hy(t)$ are the unit step responses of the channels, with initial value of zero and final value of one.

Now if both channels are identical, $Hx(t) = Hy(t)$ and Equations (1) and (2) can be combined to express Y as a function of X , with time as a parameter:

$$y(t) - Y_1 = \frac{Y_2 - Y_1}{X_2 - X_1} \left[x(t) - X_1 \right] \quad \text{for } t > 0 \quad (3)$$

Eq. 3 describes a straight line of undetermined length in X-Y space passing through the points X_1 , Y_1 and X_2 , Y_2 , which is the desired result. If Hx and Hy are further

restricted to increase monotonically from zero to one (no overshoot), Eq. 3 describes a line of specific length connecting these points.

The prefilters in the analog channels convert the step function changes at the DAC outputs into smoothly changing functions, such that for jumps of 5 inches or less in either coordinate, neither the acceleration nor the velocity limits of the servo loop are exceeded. The servo amplifiers are not driven to saturation and the loop gain remains high at all times. The servos are thus able to follow the filter output signals with only a small tracking error. Even this small error is linear and therefore can be included as part of the total filter characteristic.

Drawing long straight lines that are linear to something like 0.1% requires that the step responses be matched to that degree; this is accomplished by making the servo loop bandwidth somewhat greater than the filter bandwidth so the overall step response is determined primarily by the passive filter whose response is stable and predictable.

Plots Positive and Negative

The HP Model 9125A has been designed as a four-quadrant machine. Front panel controls allow the user to place the origin (0, 0) at anywhere on the paper surface, to accommodate negative data points.

It is a floating recorder with high common-mode rejection and is designed to respond both to positive and negative numbers. For negative numbers, FET switches reverse the DAC output. In using plotters that respond to positive numbers only, it becomes necessary to translate negative numbers to positive. The reversing switch arrangement of the Model 9125A eliminates additional program steps necessary to accomplish this translation. Recorder sensitivity is adjustable to account for different scale factors of various papers.

High Resolution

The Model 9125A can plot up to 500 points per inch or 200 points per centimeter. Resolution of the digital-to-analog converters (DAC'S) is 500 counts per inch, and the overall system resolution (at the pen tip) is better than 0.005 inch. This high resolution results in faithful reproduction of detail when present in the graph.

The pen can be returned to the same data point to within 0.007 inch. Its straight lines are straight to within 0.010 inch for a 5-inch line, and a vector 5 inches long at any angle is drawn in 1 second. Under normal environmental conditions, a trace in its retrace in the opposite direction appears as a single line.

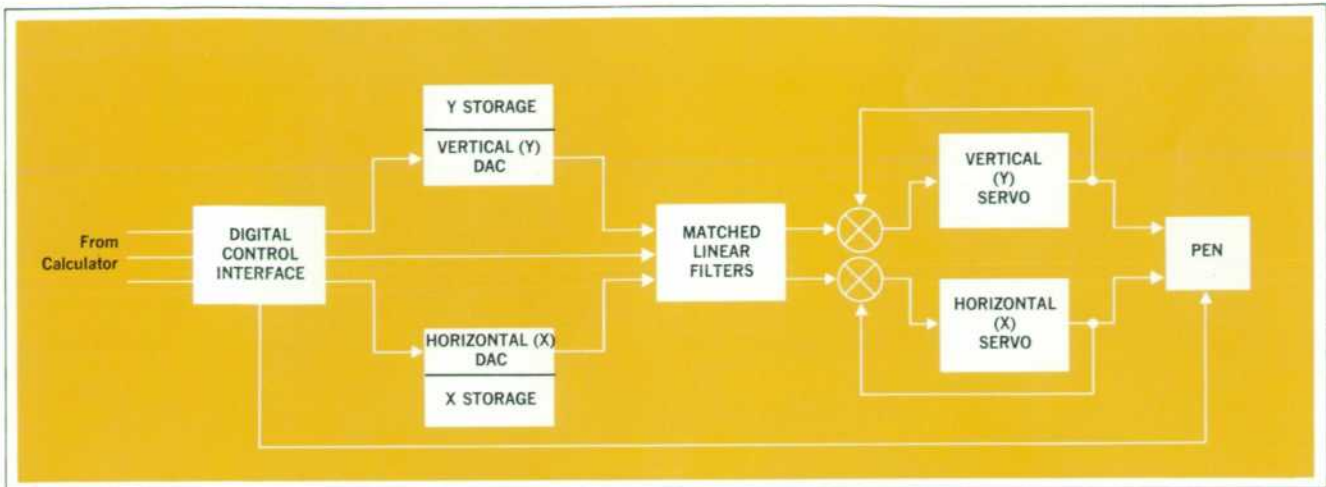

Fig. 3. In the Model 9125A X-Y Plotter, information is taken from the calculator and routed to the appropriate channel by the digital control interface circuitry.

Using a new HP liquid disposable ink cartridge, the pen will draw 2000 feet of line between changes. There is no ink mess, and the pen is easily changed, so different colors are easy to obtain on a single graph.

Off-Paper Points

Occasionally a calculated data point will be off the graph paper. Limit switches then reduce voltage applied to the servo motor. Reducing motor voltage rather than turning it off allows the motor to return the pen to the next data point that is on the paper. Sustained full voltage on the motor, while in its limit position, could damage the motor or drive system. This system also reduces noise.

Panic Button

When plotting continuous functions, the range of the variables is often underestimated by the programmer, with the result that the recorder mechanism is driven to

the limits of its travel in one or both axes. The calculator goes on cycling through the program loop, but the plotter is now generating an obviously unacceptable graph. This can upset the operator and his immediate wish is to make the plotter stop whatever it is doing in this panic situation.

Pressing the STOP key on the calculator brings program execution to a halt and activates a STOP control line output to the plotter control mechanism. In response to this signal, the plotter pen immediately lifts and returns to the origin of the X-Y plot. The STOP key also provides a means for zeroing the plotter so that the operator can adjust the position of his coordinate system origin.

Pause

When plotting a continuous curve, the operator may wish to stop program execution without disturbing the plotter. He may decide to modify the plotting increment

SPECIFICATIONS

HP Model 9125A X-Y Plotter

X-Y PLOTTER: The 9125A provides permanent graphic solutions of problems solved by the 9100A Calculator. It plots a point, specified by the numbers in the Calculator's X and Y registers, when the format (FMT) instruction is activated. Points (or points connected by straight lines) may be plotted under manual or programmed control.

PLOTTING AREA: 10 inches on the Y axis by 15 inches on the X axis. (25 cm by 38 cm on metric paper.)

ORIGIN: Origin can be set anywhere on the plotting surface, allowing four-quadrant plotting.

SCALE FACTOR: 500 counts per inch. (200 counts per cm.) Adjustable by at least ± 10 counts per inch (4 counts per cm) by front panel scale vernier control.

PLOTTING ACCURACY: ± 0.03 inch (0.8 mm).

DYNAMIC ACCURACY: Deviation from straight line between two data points in less than ± 0.04 inch (1.0 mm) for data points up to 5 inches (12.5 cm) apart, at constant ambient temperature.

RESETTABILITY: ± 0.007 inch (0.18 mm).

PLOTTING TIME: Minimum of 0.9 second from one plot point to the next, or the calculation period, whichever is greater.

TEMPERATURE: Temperature considerations for these specifications are:

ORIGIN: Stability better than 0.0008 in/ $^{\circ}$ C (0.02 mm/ $^{\circ}$ C).

SCALE FACTOR: Temperature coefficient less than 0.02% / $^{\circ}$ C.

PLOTTING ACCURACY: Above specification holds, 5-55 $^{\circ}$ C.

DYNAMIC ACCURACY: 20-26 $^{\circ}$ C, deviation ± 0.04 in (1.0 mm).

15-35 $^{\circ}$ C, deviation ± 0.04 in (1.0 mm), $\pm 0.2\%$ of displacement.

5-55 $^{\circ}$ C, deviation ± 0.04 in (1.0 mm), $\pm 0.5\%$ of displacement.

RESETTABILITY: Above specification holds, 5-55 $^{\circ}$ C.

GENERAL

WEIGHT: Net 40 lbs (18.1 kg). Shipping 50 lbs (22.7 kg).

POWER: 115 or 230 V $\pm 10\%$ (slide switch), 50-400 Hz, 100 watts.

DIMENSIONS: 8 $\frac{1}{2}$ in high by 20 in wide by 19 $\frac{1}{8}$ in deep, (213 mm x 500 mm x 484 mm).

PRICE: HP 9125A, \$2475.00

Plotter Paper

To gain maximum benefit from the highly-accurate 9125A X-Y Recorder, we recommend precision-ruled plotting paper. Hewlett-Packard Company offers a wide variety of papers, available through all field offices. These are 11 in by 17 in overall, and are packaged 100 sheets per box. Price: \$4.90 per box.

MANUFACTURING DIVISION: SAN DIEGO DIVISION
16870 W. Bernardo Dr.
San Diego, California 92127

size for example, and then continue plotting where he left off. Holding down the PAUSE key will cause the calculator to halt whenever it executes a plot command. If the CONTINUE key is pressed, the program resumes, executing the next instruction following the plot command instruction.

Keyboard Lockout

While the calculator is waiting for a CONTINUE signal from the plotter, it is in its display mode. In this mode it normally responds to keyboard inputs. To prevent accidental keyboard inputs from wrecking the plot, the entire calculator keyboard is inhibited except for the STOP and PAUSE keys, as the operator should expect.

Improper Data Warning

A command to the plotter when improper data are in the X and Y registers of the calculator causes the pen to lift and the IMPROPER DATA FORMAT light to come on. During a program, the pen will not return to the paper until data of the proper format are received. An improper data point is, basically, a number too large to be within the linear range of the digital-to-analog converters. Such an improper number will not be plotted.

Precision Graph Paper

The usual commercial graph papers do not do justice to the inherent accuracy of the Model 9125A. Graph paper manufactured to very close margin and squareness tolerances is supplied by Hewlett-Packard. Printing accuracy typically is within 0.005 inch. Silent, electrostatic paper holddown is used which permits the use of paper of any size up to 11 x 17 inches.

Acknowledgments

The authors gratefully acknowledge the contributions of many people in the Hewlett-Packard Laboratories especially Dick Monnier, section leader, and Chris Clare who was helpful in determining the calculator interface requirements. Frank Lee of HP Labs did the circuit layout of the control logic and DAC boards. At the San Diego Division, Ken Slavin did the mechanical design and packaging and Tom Barker did a great deal of work aimed toward getting the plotter into production. Thanks are also due company president Bill Hewlett, and vice president Barney Oliver for their helpful suggestions. 📄

Reference

¹ 'The Model 9100A Computing Calculator', **Hewlett-Packard Journal**, September 1968.



Robert W. Colpitts

Bob joined Hewlett-Packard in 1961, shortly after receiving his BSEE from Massachusetts Institute of Technology. He joined the HP Laboratories, and attended Stanford University with HP Honors Cooperative Program. He received his MSEE from Stanford in 1965.

Bob worked on the HP Model 241A Pushbutton Oscillator and contributed an article to the *Hewlett-Packard Journal*, August 1963. He also worked on the Model 4815A RF Vector Impedance Meter and designed the electronic control circuitry for the Model 9125A.

For recreation, Bob hunts and skis. He has several patents pending and he is a member of IEEE.



Dan Allen

Dan has a BSEE from the University of Texas (Jan. 1968) and worked in the sonar field as a technician while attending college. He joined Hewlett-Packard early in 1968 and has been design engineer on the electronic portion of the Model 9125A.

Dan's hobbies include tennis and handball.



Tom Vos

After graduating from California State Polytechnic College in 1964, Tom worked as an electronics design engineer. He joined Hewlett-Packard in 1966 and has worked on the Model 9125A.

Tom enjoys fishing in his spare time. He is a member of IEEE and Sigma Pi Alpha, honorary engineering fraternity.

Plotter Applications

Most engineers probably are familiar with William R. Hewlett's RC Wien Bridge oscillator, the Hewlett-Packard Company's first product. The circuit included an incandescent lamp as a thermally variable resistance in the feedback loop, giving the oscillator its typical constancy of output level over a wide range of operating conditions. In 1960 Bernard M. Oliver demonstrated¹ that the characteristic stability of the oscillator depended also upon a slight degree of compressive nonlinearity in its amplifier.

His interest in the behavior of the oscillator still continuing, Hewlett (now president and chief executive officer) contributed the calculated curve shown here. It is the shape of the start-up of oscillations just after turn-on, plotted by the 9125A in response to 9100 programmed calculations.

¹ Bernard M. Oliver, 'The Effect of μ -Circuit Non-Linearity on the Amplitude Stability of RC Oscillators,' *Hewlett-Packard Journal*, Vol. 11, No. 8-10; April-June 1960.



The curve is the solution to the equation

$$\ddot{y} + G(\bar{y}^2 - \frac{1}{2})y + y = 0 \quad (1)$$

G represents the gain of the amplifier in the feedback loop and

$$y_{i+1}^2 = (1 - \epsilon)\bar{y}_{i+1}^2 + \epsilon y_i^2 \quad (2)$$

\bar{y}_i^2 will be recognized as the mean

squared value of the oscillation amplitude with the past contribution disappearing exponentially with time. For the frequency domain this represents the real pole contributed by the thermal time constant of the lamp. Thus the damping term may be positive or negative, depending upon the immediate past history of the oscillation amplitude.

Antenna Plots

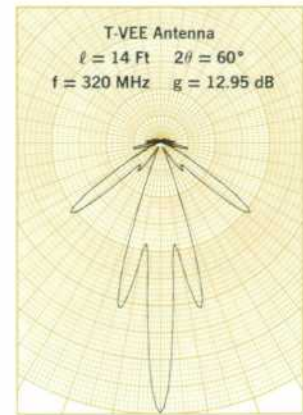
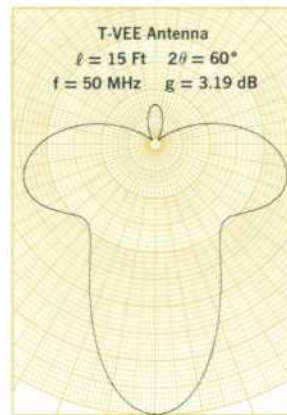
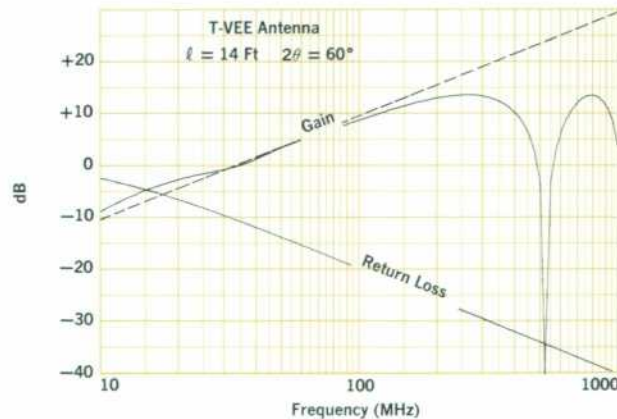

In the February 1964 issue of the Hewlett-Packard Journal a Time Domain Reflectometer response was shown, Fig. 21(b), of a broad-band 60° V antenna having triangular sides 14 feet long and 4 feet eight inches high at the outer ends, Fig. 20(b). It was observed that this antenna, being a 300 Ω conical line, produced no reflection at the apex, or throat, and a reflection at the open end, or mouth, closely resembling an exponential rise. Thus the reflection coefficient in this plane can be represented as a single pole: $\rho_o = \frac{\omega_o}{p + \omega_o}$. From this it follows that the reflection coefficient referred to the throat is $\rho_\phi = \rho_o e^{-14\pi\ell/\lambda}$, and that the antenna gain in the azimuth plane in a direction ϕ is

$$g(\phi) = \frac{30}{Z_o} \left| \left\{ \frac{e^{2\pi i [\cos(\theta - \phi) - 1] \ell / \lambda} - 1}{\cos(\theta - \phi) - 1} \sin(\theta - \phi) + \frac{e^{2\pi i [\cos(\theta - \phi) - 1] \ell / \lambda} - 1}{\cos(\theta + \phi) - 1} \sin(\theta + \phi) \right\} - \rho \left\{ \frac{e^{2\pi i [\cos(\theta - \phi) + 1] \ell / \lambda} - 1}{\cos(\theta - \phi) + 1} \sin(\theta - \phi) + \frac{e^{2\pi i [\cos(\theta - \phi) + 1] \ell / \lambda} - 1}{\cos(\theta + \phi) + 1} \sin(\theta + \phi) \right\} \right|^2$$

Here, θ = angle between the sides. The first two terms arise from the forward traveling wave in the two arms, while the second two terms arise from the reflected waves.

The 9100A was programmed to compute $\frac{g(\phi)}{g(0)}$ at 1° intervals and to plot the results on the 9125A recorder. In addition, the program was then modified to plot the gain and return loss versus frequency. The dashed gain line (drawn by hand) is the gain, $10 \log \frac{4\pi A}{\lambda^2}$, of an antenna whose effective area, A, is the mouth area of the V-antenna. Note that up to about 220 MHz the two curves agree within 3 dB. Above this frequency pattern breakup occurs and the actual gain drops well below that predicted by the mouth area.

High-Resolution Time-Domain Reflectometry With a Portable 30-lb Instrument

State-of-the-art sampling oscillography gives 35 ps system risetime to a direct-reading plug-in for the 180-series oscilloscopes.

By Jeffrey H. Smith

WITH A HIGH-RESOLUTION TIME DOMAIN REFLECTOMETER displaying a picture of what's happening, the electronic designer can locate and identify small impedance mismatches or discontinuities in coaxial or stripline systems. The Time Domain Reflectometer makes visible both the physical location and the electrical nature of mismatches, providing information the designer needs to quickly 'clean up' his system for undistorted transmission of fast-rise pulses or for maximum transfer of broadband RF power. The design of broadband connectors, attenuators, hybrid circuits, and many other components is thus speeded with the clues toward corrective action provided by a high-resolution Time Domain Reflectometer (TDR).

The TDR technique consists of sending a burst of energy into the system under test, then using an oscilloscope to observe the timing and nature of reflections resulting from impedance discontinuities. The ability of a practical TDR system to resolve small discontinuities, and to identify them, is determined primarily by two characteristics of the TDR: the risetime of the incident voltage step, and the signal-to-noise ratio of the displayed response. The step risetime determines both the magnitude of the reflection produced by a given discontinuity, and the minimum spacing between two discontinuities that the TDR system can resolve. Very fast risetimes are desirable to decrease the minimum observable spacing. Signal-to-noise ratio, which is affected by TDR system noise and other residual perturbations and reflections, limits the system's ability to detect small discontinuities, and also the minimum observable spacing.

Resolution may be degraded further by losses and reflections in cables and connectors attaching the TDR to the device under test. In a fast risetime system, these losses are not insignificant. For example, a three-foot

length of RG55/U cable inserted between a TDR unit and a tested device degrades a 35 ps system response to approximately 80 ps. Even high quality air-dielectric lines, usually used to minimize losses, degrade risetime somewhat—a reduction from 35 ps to 37 ps in the case of a 10cm-long section of 7mm diameter line.

Consider a system consisting of two ideal capacitors connected between center conductor and ground of a lossless coaxial line. The response of this system as observed

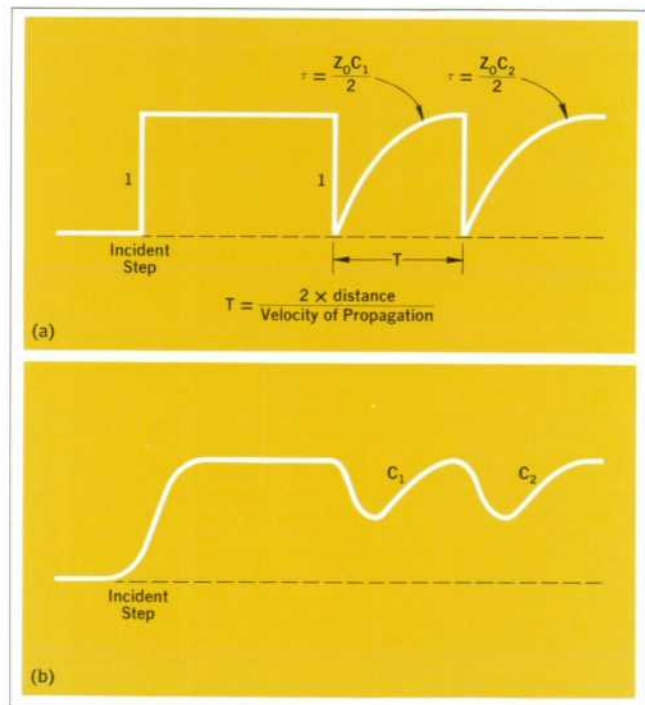

Fig. 1a. Response of ideal zero-risetime time-domain reflectometer to two capacitors bridging lossless line. Response of realizable (risetime-limited) time-domain reflectometer is shown in 1b.

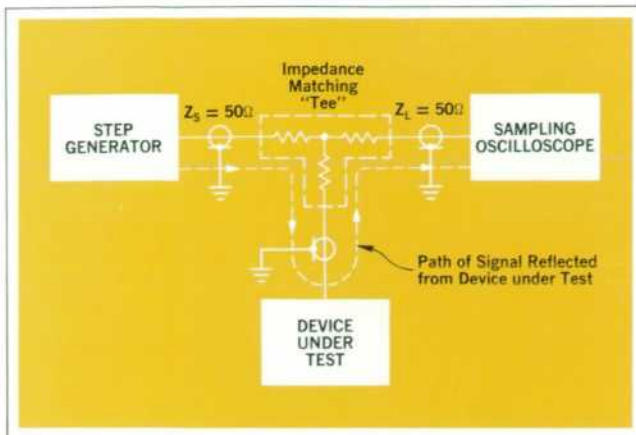

Fig. 2. Time domain reflectometer using ordinary lab instruments.

on an ideal zero-risetime TDR would be as shown in Fig. 1a. To determine how this response would appear on a physically realizable TDR, the waveform may be treated as the input to a filter that has a step response identical to the step response of the pulse generator-oscilloscope combination comprising the TDR.¹ This produces the response shown in Fig. 1b. For small values of capacitance, the effect of the TDR's finite risetime is to reduce the amplitude of the response and to increase its width, while the area underneath the waveform remains constant. The limit of resolution is reached when these responses overlap so they become indistinguishable.

TDR Configurations

Given the risetime available with present state-of-the-art pulse generators and oscilloscopes, the resolution obtainable from a TDR system also depends considerably on how the system elements — the pulse source, the oscilloscope, and the device under test — are interconnected. The most general type of TDR system, that which places fewest restrictions on the nature of these elements, is

1. Oliver, B. M., 'Time Domain Reflectometry,' *Hewlett-Packard Journal*, Vol. 15, No. 6, Feb. 1964.

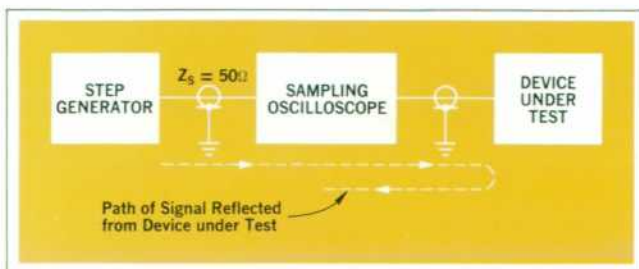

Fig. 3. Time domain reflectometer using oscilloscope with feedthrough sampler.

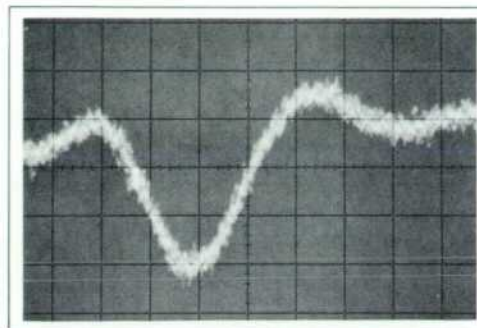

Fig. 4. Resolution obtainable with 1815A TDR system using 28ps sampling head and 20ps step generator. Reflection shown is from 0.02pF (2×10^{-14} F) capacitor shunting 50 Ω transmission line. Vertical deflection factor: 0.005 μ /div; horizontal: 0.02 ft/div.

shown in Fig. 2. A resistive 'tee' is required here to enable each of the three devices to 'see' an impedance equal to its characteristic impedance. Otherwise, serious reflections would be created at the junction of the three lines.

If all the elements have the same impedance, the signal loss is 6 dB each time the signal passes through the tee. This results in a total loss of 12 dB since the signal passes through the tee twice, decreasing resolution because of the reduced ratio of signal to oscilloscope noise. Another problem with this setup is the large number of paths for undesired reflections.

Much improved resolution is possible if one of the elements is a bridging or feedthrough device, that is, a two-port device that feeds most of the signal incident on one port through to the other port. The most logical choice here would be to make either the oscilloscope or the pulse generator a feedthrough device, as this places fewest restrictions on the nature of the device to be tested. Systems that depend on feedthrough capabilities in the tested device are severely restricted in their range of applications because any transmission loss in the tested device degrades overall TDR system performance.

Hewlett-Packard's development of a high-speed feedthrough sampler for the oscilloscope has made it possible to assemble practical TDR systems in the configurations shown in Fig. 3. Systems using this sampler achieve overall system response better than 35 ps.

Until now, these high-resolution systems consisted of a general-purpose sampling oscilloscope and a fast-rise pulse generator. Such an arrangement requires the user to exercise care in interpreting control settings because the controls are not calibrated for time domain reflectometry. A new plug-in for the 180-series oscilloscopes combines high-resolution components into a TDR system that is



Fig. 5. 1815 Time Domain Reflectometer system works with either of two sampling heads and related tunnel-diode step generators. 1815A Plug-in here is installed in Model 181A Variable-Persistence Oscilloscope mainframe. It also works with Models 180A and 183A mainframes.

direct reading, the first to be designed and calibrated specifically for high-resolution TDR. Besides using a 28 ps sampler and 20 ps pulse generator for the maximum time-domain resolution presently attainable, this system also achieves higher levels of signal-to-noise ratio with a new signal-averaging technique. The kind of resolution obtainable with the system is shown in Fig. 4.

The 1815A System

The new TDR system (Fig. 5) consists of a 180-series Oscilloscope mainframe, a new TDR/Sampler plug-in (Model 1815A), a sampling head, and a tunnel-diode pulse generator that mounts directly on the sampling head. To keep signal losses in the interconnecting cables as low as possible, the sampling head is separate from the plug-in so that it can be placed adjacent to the device or system being tested.

The new TDR system can find impedance discontinuities in transmission systems up to 10,000 feet long. At close range, it can measure discontinuities spaced only a few millimeters apart. It has recorder outputs (rear panel) and the traditional scan functions, i.e., single, repetitive, detail (high sampling density), manual, and recorder (slow scan). It also functions as a general-purpose, single-channel sampling oscilloscope with deflection factors ranging to 2 mV/div and sweep times to 10 ps/div.

Two sampling heads are available. The Model 1817A has a risetime of 28 ps, equivalent to a CW bandwidth of dc to 12.4 GHz. The less expensive Model 1816A has a risetime of 90 ps and a CW bandwidth, when used as a

sampling oscilloscope, of 4.0 GHz. For best resolution and accuracy, both of these heads use feedthrough, i.e. bridging, samplers.

Two tunnel-diode pulse generating mounts, both with outputs of at least 200 mV into 50 Ω and with closely-controlled source impedance of 50 $\Omega \pm 2\%$, are available. The Model 1106A generator has a step risetime of 20 ps, which gives a TDR system risetime of 35 ps when used with the 28 ps sampling head. The Model 1108A generator's risetime is 60 ps, giving a TDR system risetime of 110 ps with the 90 ps sampling head. These tunnel-diode mounts derive bias and trigger signals from the sampling head and require no adjustment in normal use. Because the mounts are separate, the device being tested may be inserted between the pulse source and sampler when transmission measurements are desired.

The Hewlett-Packard 180-series Oscilloscope mainframe provides a portable package operable in environments from 0 to +55°C and in 95% relative humidity up to 40°C—the 1815 TDR system may thus be used

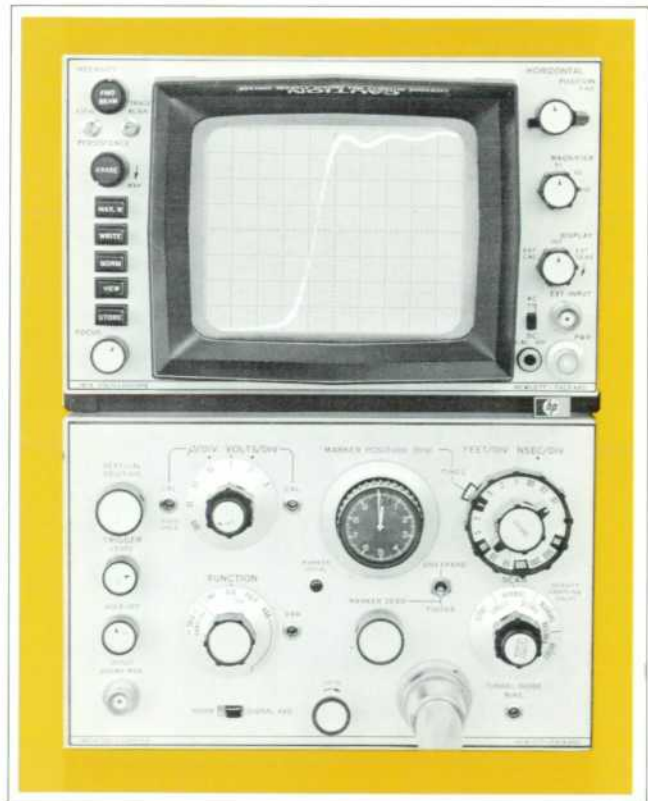

Fig. 6. Front panel view of Model 1815A TDR/Sampler plug-in in Model 181A Oscilloscope mainframe. Outer concentric control (FEET-NSEC/DIV) switches in decade steps so only decimal point placement need be considered in reading MARKER POSITION dial. Sweep magnifier (EXPAND) is on inner concentric knob and reads horizontal scale calibration directly.

on the flight line or at other remote locations. Its 30-lb weight and small size make it easy to carry up antenna masts and easy to maneuver through the confines of ships and other closely spaced installations.

Ease of Use

Operator convenience was taken as a major design goal during development of the 1815 system. Special consideration was given to simplifying front-panel controls without reducing versatility (Fig. 6). The FUNCTION switch selects a vertical display calibration in units of ρ (reflection coefficient), for direct reading of reflection coefficient when the system is used for time domain reflectometry, or in volts when it is used as a sampling oscilloscope. Calibrated ranges for both ρ and volts are from 0.5/div to 0.005/div, with a vernier extending the low end to 0.002/div. Indicator lights show whether vertical calibration in ρ /div or volts/div is selected by the FUNCTION switch.

The instrument has calibrated distance ranges from 0.01 feet/div to 1000 feet/div. Although an oscilloscope measures in the time domain, distance is usually the information desired. Because propagation time depends on a cable's dielectric constant, a given time increment does not represent the same cable length on all types of cable.* The 1815A FUNCTION switch selects calibrated sweep speeds that display the distance along either air-dielectric or polyethylene-dielectric cables directly in feet/division. Another switch position allows front-panel screwdriver adjustment of calibration for direct readout of distance on transmission systems that have any other relative dielectric constant between 1 and 4.

If desired, horizontal information may be displayed as a function of time, with calibrated time scales from 10 ps/div to 1 μ s/div. Indicator lights show whether horizontal calibration in FEET/DIV or NSEC/DIV is selected.

The concentric arrangement of horizontal controls allows all horizontal scale factors to be read directly. The operator need not divide a basic time scale setting by a magnification factor to obtain the horizontal calibration of his display (see Fig. 6).

An optional version of the 1815A TDR plug-in (Model 1815B) has distance calibrations that read in meters/div rather than feet/div.

Calibrated Marker

The 1815A has a calibrated marker, a brightened dot on the CRT trace whose horizontal position is read out directly by a ten-turn precision control. This is a particularly useful feature during TDR examination of systems with several discontinuities. For example, Fig. 7 shows the display resulting from a coaxial system that has a number of closely spaced discontinuities that a person might want to locate and examine separately. Point A represents the incident TDR step and the section between A and B is a short cable connecting the TDR to the system being tested. To reference all distance measurements to the

* Time between incident step and reflection = $2 \times \text{Cable Length} \times \text{Velocity of Propagation} = \frac{2 \text{ cd}}{\sqrt{E_r}}$
 $c = \text{Velocity of Light} = 9.9 \times 10^8 \text{ ft/s.}$
 $d = \text{Length of system between sampler and discontinuity}$
 $E_r = \text{Relative dielectric constant of system under test (} E_r = 1.0 \text{ for vacuum)}$

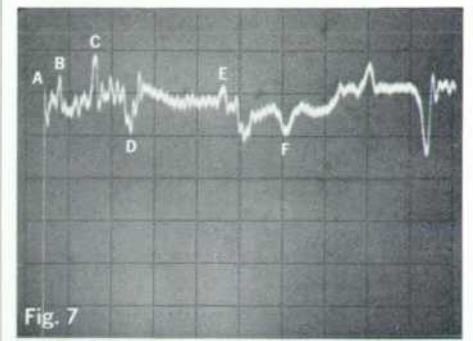

Fig. 7

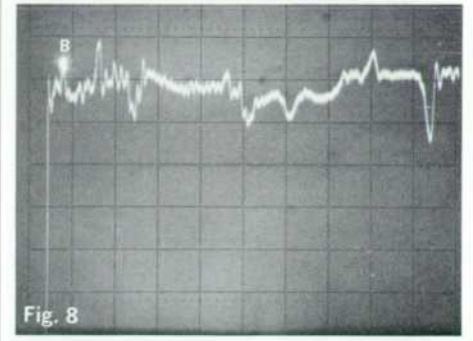

Fig. 8

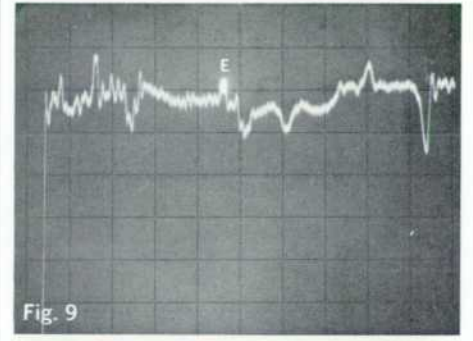

Fig. 9

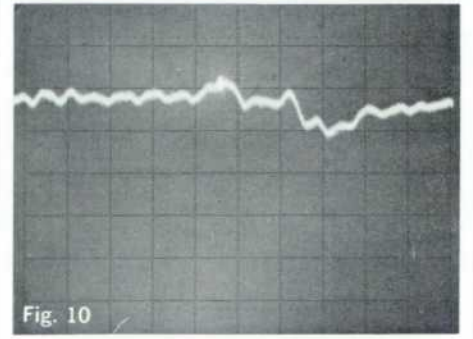

Fig. 10

Fig. 7. Typical TDR display of system with several impedance discontinuities. Point A represents TDR incident voltage step, section from A to B is connecting cable, C, D, E, and F are impedance discontinuities. (Sweep time: 1 ns/div; vertical deflection factor: $\rho = 0.05/\text{div}$.) **Fig. 8.** MARKER ZERO control places marker on point B representing input to system under test. **Fig. 9.** Following step described in Fig. 8, MARKER POSITION dial is used to place marker on point of interest. Distance from system input to point of interest may now be read directly on MARKER POSITION dial. **Fig. 10.** Expanded portion of display shown in Fig. 9. (Sweep time: 0.2 ns/div.)

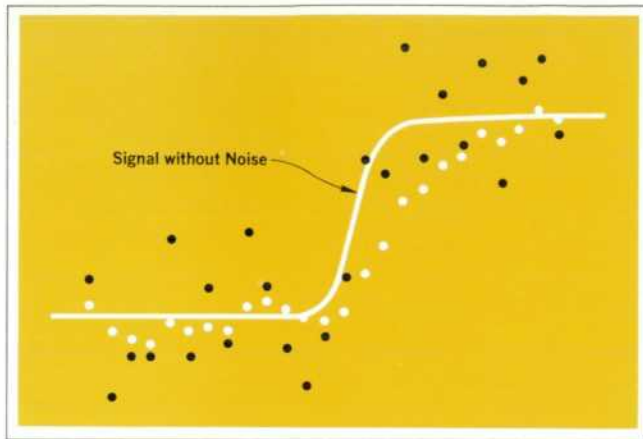

Fig. 11. Display of voltage step by sampling scope set for 100% sampling efficiency (black dots) and for 25% sampling efficiency (white dots). Note smoothing of response with reduced sampling efficiency, and consequent loss of risetime. (Horizontal dot spacing is exaggerated for purposes of illustration.)

system input, the operator merely depresses the ZERO FINDER switch and uses the MARKER ZERO dial to position the marker on B, as shown in Fig. 8. He now releases the ZERO FINDER switch and uses the MARKER POSITION dial to place the marker on reflection E (Fig. 9). The distance from the system's input (point B) to point E may now be read directly from this dial. The horizontal magnifier always expands about the marker so, if the operator wishes to examine this discontinuity in greater detail, he need merely operate the EXPAND switch to obtain a display like that shown in Fig. 10.

Signal Averaging Improves S/N Ratio

As discussed earlier, noise is one of the factors limiting the resolution of a TDR system. A new type of signal-averaging circuit in the 1815A reduces the effects of most types of non-periodic noise and jitter by more than half,

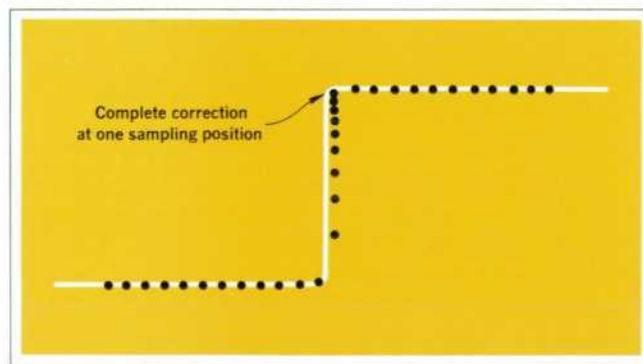

Fig. 12. When signal averaging is used, samples converge towards true waveform value while horizontal movement is stopped. (Horizontal dot spacing exaggerated.)

and it is effective whether the noise is introduced within the oscilloscope or is present in the system being tested.

In the past, most general-purpose sampling oscilloscopes offered smoothing as a means of reducing noise. In the smoothed mode, the gain of the sampling loop is decreased to reduce the effective sampling efficiency below 100%. For example, the white dots in Fig. 11 show a noisy signal displayed on a sampling scope set for about 25% effective sampling efficiency, that is, each sample is displayed at a point only 25% of the vertical distance between the previous sample and the point where it would be if sampling efficiency were 100%. Contrast these with the black dots, which show the same signal observed with a sampling scope set for 100% sampling efficiency, that is, each sample displays the actual voltage present at the sampling gate when the sample is taken. Note that reducing sampling efficiency reduces the noise appreciably, but it also reduces the observed signal risetime. The lost signal risetime may be regained by spacing samples more closely horizontally, but it is still possible to miss narrow impulses or high-frequency ringing.

The signal-averaging circuits in the 1815A reduce noise without losing high-frequency information. With this system, sampling efficiency is reduced and several samples are taken at the same point on successive repetitions of the TDR waveform before the display is stepped horizontally to the next sampling position. This allows the amplitude of each sample to converge towards its true value, as shown in Fig. 12. The improvement in signal-to-noise ratio is shown in Fig. 13.

With signal averaging, the display rate is slower than normal because of the greater number of samples required to complete a scan. However, the VERTICAL SENSITIVITY switch selects sampling efficiency and number of samples (10 to 250) at each point for the best compromise between noise reduction and display rate.

Stable Sampling Loop

As a further step towards simplifying operation of the 1815A, the front panel does not have sampling response and sampling efficiency adjustments. This simplification was made possible by a new, highly stable sample strobe circuit.

A simplified sampling gate is shown schematically in Fig. 14. Response of the sampling gate is determined by, among other things, the length of time that the gate is open. Because the circuit time constant is much longer than the time the sampling gate is open, the sampling capacitor does not charge to 100 percent of the signal amplitude.

The percentage of the sampled signal appearing on the capacitor is influenced by the strobe pulse width, which determines how long the sampling gate is open, and by the strobe pulse amplitude, which determines the effective resistance of the sampling diodes, and also by the impedance of the circuit connected to the sampler input, which affects the sampling circuit time constant.

Variations in sampling efficiency caused by changing source impedance may be eliminated by making the electrical length of a feedthrough sampler sufficiently long that a signal does not have time to travel from the sampling gate to its connector and be reflected back to the gate until after the gate has closed. This assures that the sampling gate sees a constant impedance equal to $Z_0/2$.

Variations in the strobe pulse result primarily from variations in the minority carrier lifetime of the step recovery diode that generates the strobe pulse. To see how this occurs, a simplified step recovery diode pulse-sharpening circuit is shown in Fig. 15. Charge stored in the diode's p-n junction by forward current, I_f , is removed by the reverse current that flows after the switch is closed. When the charge depletes, at time T_1 in the diagram, the diode stops conducting abruptly, thereby generating a sharp voltage step (the sampling diode strobe impulse is obtained by differentiating this step).

The amplitude and risetime of the step is determined, in part, by the amount of stored charge in the diode at the instant the switch closes. The stored charge Q_s equals $I_f \tau$, where τ is the effective minority carrier lifetime. Since minority carrier lifetime depends on temperature, the size and shape of the strobe pulse varies with temperature. Hence, a front-panel control has been provided on sampling scopes to compensate for these variations.



Jeffrey H. Smith

Jeff Smith has spent his entire professional career among pulses and samples, starting at HP in 1963 with the 1103A Trigger Countdown for the 185-series Sampling Scopes and with other advanced sampling scope projects. Along the way, he contributed to the 1425A Delaying Time Base for the 140 family of sampling plug-ins, to the 1920A 350ps risetime Output Module for the 1900-series

Pulse Generators, and to a 100MHz rate generator. Jeff hails from San Carlos, California, but fishing and skiing in the Colorado Rockies suit him just fine. He earned both his BSEE and MSEE degrees at Stanford.

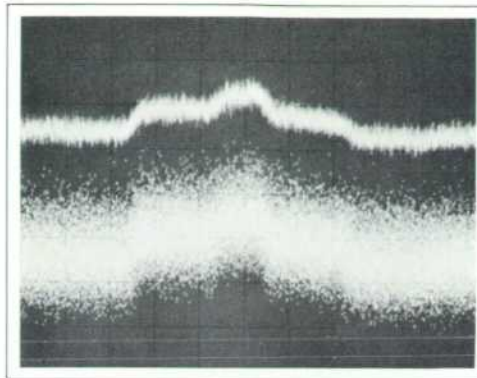

Fig. 13. Improvement in signal-to-noise ratio (upper trace) obtained with signal averaging system built into new TDR unit.

This situation is avoided in the 1815A by use of the strobe circuit shown in Fig. 16. The amount of charge stored in the step recovery diode now depends on the preshoot 'spike', and since the width of the preshoot is much less than τ , the stored charge is nearly independent of τ . Thus, the strobe pulse is uniform with respect to temperature changes.

This sampling gate is sufficiently stable that response and smoothing adjustments may be preset internally. It is this temperature stability that makes it practical to have portability in a high-resolution TDR system.

Sampling Oscilloscope

The Model 1815A/B plug-in also has a trigger circuit that allows the unit to be used as a general-purpose single-channel sampling oscilloscope. This circuit triggers on pulses as small as 5 mV and on CW signals to above 500 MHz. With larger triggers, it is usable to 1 GHz. In addition, the TDR tunnel-diode mounts may be used with an inexpensive power supply (HP Model 1104A) to serve

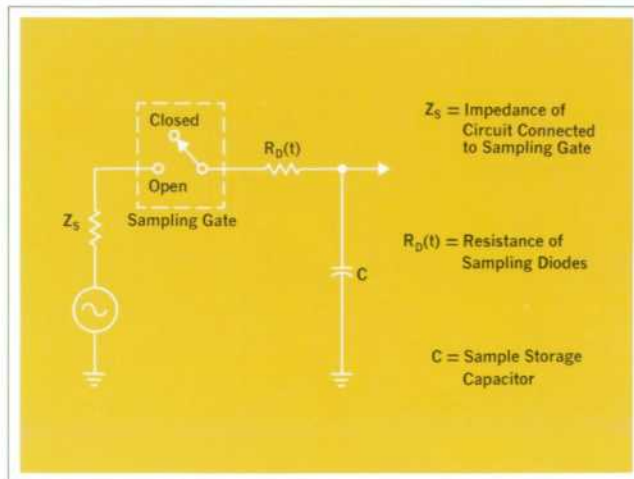

Fig. 14. Simplified diagram of sampling circuit.

Fig. 15. Step recovery diode pulse-sharpening circuit. When switch is closed (time T_0), voltage at point A remains near ground potential until T_1 , when charge stored in step recovery diode depletes. **Fig. 16.** Modified pulse-sharpening circuit uses waveform spike to charge step recovery diode. Charge is unaffected by temperature-induced changes in diode characteristics.

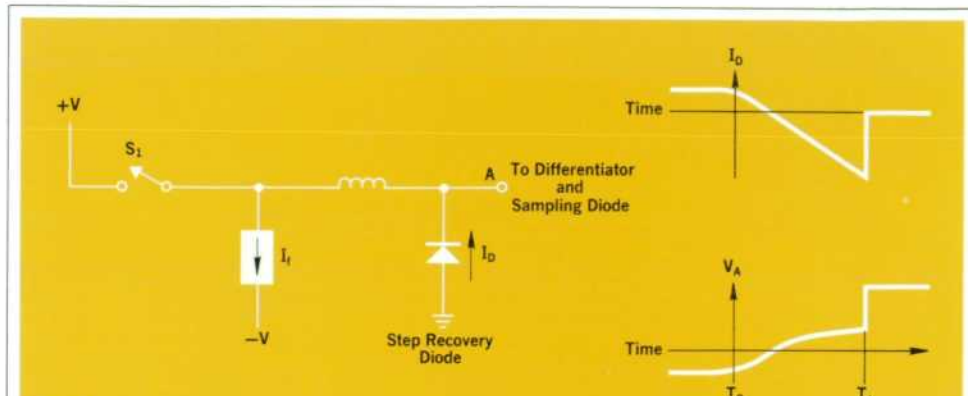

Fig. 15

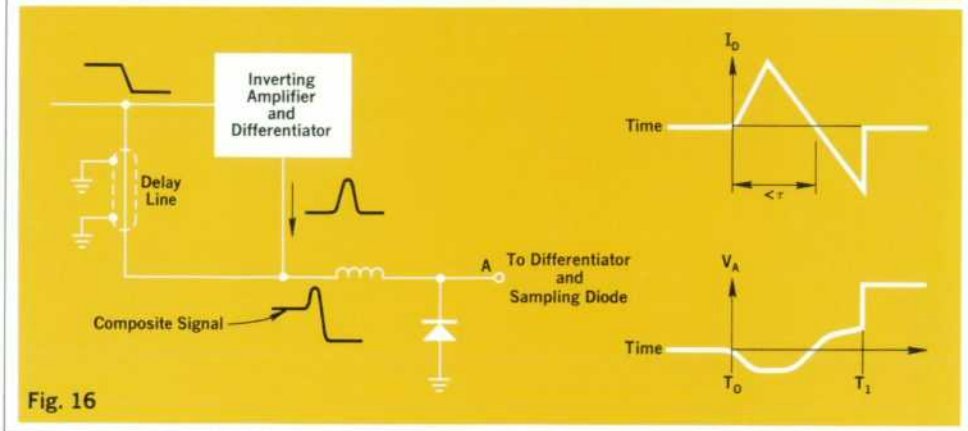

Fig. 16

as trigger countdowns on signal frequencies up to 18 GHz, with the model 1106A tunnel-diode mount, or to 10 GHz with the Model 1108A. The signal-averaging and direct-reading marker features are also effective when this system is used as a sampling oscilloscope.

Acknowledgment

Allen Best was the group leader responsible for carrying the 1815 system from its conception through to production. George Blinn did the product design for the 1815A and 1815B. Circuit design for the vertical display portions of these instruments was performed by Gordon Greenley while John Tulloch designed the horizontal display

circuits. Product design for the 1816A, 1817A, and 1108A was by Bob Montoya. Circuits for the 1817A and 1108A were designed by Jim Painter, and Ed Prijatelj served as circuit designer for the 1816A. Max Wood has given us much help as a technician both during system development and during early phases of production.

SPECIFICATIONS

1815A/B

TDR/Sampler Plug-In

TDR and Sampler performance specifications are identical except where indicated (TDR specification given first followed by Sampler specification in parentheses).

VERTICAL

SCALE: Reflection coefficient ρ (volts) from 0.005/div to 0.5/div in 1, 2, 5 sequence.

ACCURACY: $\pm 3\%$; TDR only, $\pm 5\%$ on 0.01/div and 0.005/div scales in signal-average mode.

VERNIER: For continuous adjustment between ranges; extends scale below 0.002/div.

SIGNAL AVERAGE: Reduces noise and jitter approx. 2:1.

HORIZONTAL

SCALE: Round-trip time or distance (time) in four calibrated ranges: 1, 10, 100, and 1000/div. Concentric EXPAND control provides direct readout in calibrated steps from 0.01 to 1000 ns/div or from 0.01 to 1000 ft/div (0.01 to 1000 ns/div) in 1, 2, 5 sequence.

ACCURACY: Time, $\pm 3\%$; distance, TDR only, $\pm 3\% \pm$ variations in propagation velocity.

MARKER POSITION: Ten-turn dial, calibrated in CRT divisions, for direct readout of round-trip time or distance (time).

MARKER ZERO: Ten-turn control provides variable reference for marker position dial.

ZERO FINDER: For instant location of marker reference.

DIELECTRIC (TDR only): Calibrated for air, $\epsilon = 1$, and for polyethylene, $\epsilon = 2.25$. Also variable for dielectric constants from $\epsilon = 1$ to approx. 4.

TRIGGERING (Sampling only):

PULSES: Less than 50 mV for pulses 5 ns or wider for jitter < 20 ps.

CW: Signals from 500 kHz to 500 MHz require at least 80 mV for jitter less than 2% of signal period plus 10ps; usable to 1 GHz. CW triggering may be extended to 18 GHz with HP Models 1104A/1106A trigger countdown.

RECORDER OUTPUTS: Approx 100 mV/div; vertical and horizontal outputs at BNC connectors on mainframe rear panel.

WEIGHT: Net, 5 lbs (2.3 kg); shipping, 10 lbs (4.5 kg).
PRICE: HP Model 1815A (distance calibrated in ft), \$1100, HP Model 1815B (distance calibrated in meters), \$1100.

HP Models 1817A and 1816A

28ps and 90ps Samplers

Model 1817A and Model 1816A specifications are identical except where indicated (Model 1817A specification used with Model 1106A tunnel diode mount given first followed in parentheses by Model 1816A specification used with Model 1108A tunnel diode mount).

TDR SYSTEM

SYSTEM RISE TIME: Less than 35ps (110ps) incident as measured with Model 1106A (Model 1108A).

OVERSHOOT: Less than $\pm 5\%$.

INTERNAL REFLECTIONS: Less than 10% with 45ps (145ps)

TDR; use reflected pulse with shorted output.

JITTER: Less than 15ps; with signal averaging, typically 5ps.

INTERNAL PICKUP: $\mu < 0.01$.

NOISE: Measured tangentially as percentage of incident pulse when terminated in 50 Ω and operated in signal-average mode.

Less than 1% (0.5%) on 0.005/div to 0.02/div scales; less than 3% (1%) from 0.05/div to 0.5/div.

LOW-FREQUENCY DISTORTION: $< \pm 3\%$.

MAXIMUM SAFE INPUT: 1 volt.

SAMPLER SYSTEM

RISE TIME: Less than 28ps (90ps).

INPUT: 50 Ω feedthrough.

DYNAMIC RANGE: 1 volt.

MAXIMUM SAFE INPUT: 3 volts (5 volts).

LOW-FREQUENCY DISTORTION: $< \pm 3\%$.

NOISE:

NORMAL: Less than 8 mV (3 mV) tangential noise on 0.01 V/div to 0.5 V/div scales. Noise decreases automatically on 0.005 V/div scale.

SIGNAL AVERAGE: Reduces noise and jitter approx. 2:1.

WEIGHT: Net, 3 lbs (1.4 kg); shipping, 7 lbs (3.2 kg).

PRICE: HP Model 1817A, \$1500; HP Model 1816A, \$850.

HP Models 1106A and 1108A

20ps and 60ps tunnel diode mounts

Tunnel diode mount connects directly to sampler head for TDR system.

AMPLITUDE: Greater than 200 mV into 50 Ω .

RISE TIME: Model 1106A, approx 20ps; Model 1108A, less than 60ps.

OUTPUT IMPEDANCE: 50 $\Omega \pm 2\%$.

SOURCE REFLECTION: Model 1106A, less than 10% with 45ps

TDR; Model 1108A, less than 10% with 145ps TDR.

WEIGHT: Net, 1 lb (0.5 kg); shipping, 3 lbs (1.4 kg).

PRICE: HP Model 1106A, \$550; HP Model 1108A, \$175.

Precision DC Current Sources

CCB-Series Current Sources can supply precisely regulated currents as low as 1 μ A. Programming is rapid, and tiny leakage currents are eliminated by a guarding technique.

By Joseph C. Perkinson and Willis C. Pierce, Jr.

AN IDEAL CURRENT SOURCE is a current generator which has infinite internal impedance. An ideal current source provides any voltage necessary to deliver a constant current to a load, regardless of the size of the load impedance. It will supply this same current to a short circuit, and in the case of an open circuit it will try to supply an infinite voltage (see Fig. 1).

In practical current sources neither infinite internal impedance nor infinite output voltages are possible. In fact, if the current source is to be used as a test instrument, it should have a control for limiting its maximum output voltage, so its load will be protected against the application of too much voltage. Its output impedance should be as high as possible, of course, and should remain high with increasing frequency so as to limit current transients in rapidly changing loads. A capacitor across the output terminals is to be avoided, since it will lower the output impedance, store energy which can result in undesirable transients, and slow down the programming speed.

One approach to the design of a current source is to add a high series resistance to an ordinary voltage source. However, it is difficult to achieve good current regulation

this way. Typical applications for current sources call for output impedances of a few megohms to a few hundred megohms and currents of tens or hundreds of milliamperes. This means the source voltage would have to be tens of kilovolts or more. Such a high-voltage supply will cause noise problems, will be difficult to modulate or to program rapidly, will be dangerous, will be very large, and will waste a lot of power.

Electronic current regulation is a much more tractable way to obtain high output impedance. There are still design problems, but they are of a different kind. One problem that is rather difficult to deal with is leakage.

Leakage Versus Regulation

The current regulation of a current source, as seen at the load, is degraded by any impedance in parallel with the load. If I_o is the current generated by the source, I_L is load current, Z_L is load impedance, and Z_S is the total impedance shunting Z_L , then

$$I_L = \frac{I_o Z_S}{Z_L + Z_S}$$

When the output impedance of the current source is high, then even very small leakage currents can become significant (see Fig. 2). Such things as the input impedance of a voltmeter measuring the load voltage, the insulation resistances of wiring and terminal blocks, and the surface leakage currents between conductors on printed-circuit boards will all take current away from the load, unless they are kept from doing so by the design of the current source.

CCB Current Sources

In the new Hewlett-Packard CCB Current Sources (Models 6177B, 6181B, and 6186B, Fig. 3), leakage at the output terminals is negligible, owing to a combination of techniques, including guarding, shielding, physical isolation, and hygiene. Feedback regulation makes the output impedance high (3.3 M Ω to 1300 M Ω), and there is no output capacitor to lower the output impedance or

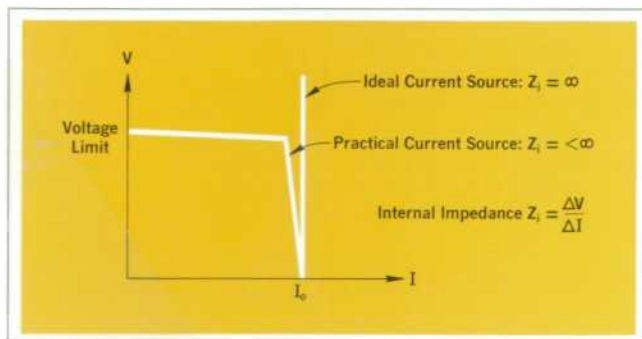

Fig. 1. An ideal current source has infinite internal impedance, delivers the same current, I_o , to any load, and supplies infinite voltage to an open circuit. A practical current source has a Z_i which is finite, but as high as possible. It should also have an adjustable voltage limit to keep the load from being damaged.

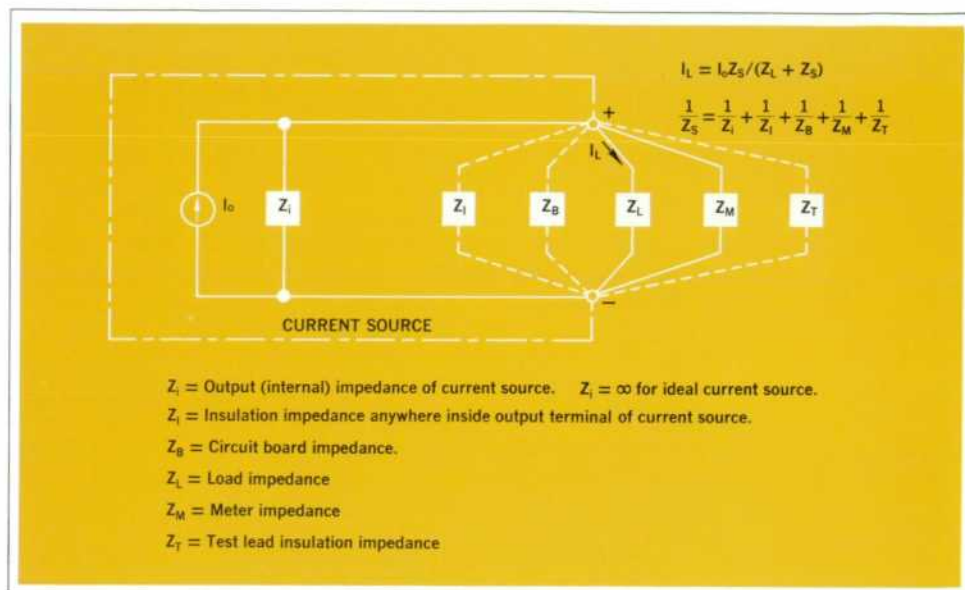

Fig. 2. The current regulation of a current source can be degraded by any impedance that shunts the load. If Z_i is high, meter and leakage impedances can be significant.

store energy. Low leakage and high output impedance result in precise current regulation. The output current changes less than 25 ppm of setting ± 5 ppm of range for a load change that swings the output voltage from zero to maximum. Currents supplied can be as small as $1 \mu\text{A}$ and as large as 500 mA, and there are no turn-on, turn-off, or power-removal overshoots, either of current or of voltage.

The CCB Current Sources also have continuously variable voltage-limit controls. Current and voltage controls are independent and can be set before the load is con-

nected. The outputs are floating, so the sources can be used as either positive or negative sources.

For systems use, the sources are programmable. Programming speed is high for this type of instrument: from 0 to 99% of the programmed output in as fast as $500 \mu\text{s}$, depending on the model. For dynamic and incremental measurements, ac modulation can be superimposed on the output current.

What's Inside

Fig. 4 is a simplified schematic of a CCB Current Source. There are four principal sections—the current

Current Sources In The Laboratory and On The Production Line

Throughout science and industry—in electronics, chemistry, biology, instrumentation, and so on—there are applications in which well-regulated constant currents are indispensable. There are other applications in which such currents are desirable because they make measurements easier. The following examples are representative of the kinds of applications for which HP CCB Current Sources are well suited.

- Semiconductor testing, e.g., evaluating reverse breakdown characteristics by supplying just enough voltage to induce avalanche breakdown, but at a controlled current low enough not to cause damage; or, measuring forward I-V characteristics of p-n junctions. CCB advantages: no output capacitor to cause current transients, guard circuit for monitoring the output with a voltmeter or X-Y recorder, programmability for automated measurements.
- Measuring dynamic or incremental impedance, e.g., the dynamic impedance of zener diodes, or the small-signal h-parameters of transistors. CCB sources are useful here because ac modulation can be superimposed on their dc output currents; hence one current source supplies both bias and modulation.

- Measuring resistances, e.g., on a production line. Measurements can be absolute-value or comparative. The known current reduces resistance measurements to voltage measurements. CCB advantages: guard circuit for measuring output voltage without perturbing load current, precise regulation.

- Measuring small resistances where contact resistance can be as high as the unknown and can vary widely, e.g., in probing integrated circuits to measure surface resistivity. The known current supplied by a current source is independent of contact resistance.

Other applications calling for well-regulated currents include:

- Precision electroplating
- Driving electromagnets
- Testing and sorting resistors, relays, and meters.
- Supplying power to loads whose impedances vary widely, e.g., devices which have negative resistance characteristics.
- Certain analytical methods, such as chronopotentiometry, coulometric titration, and electrogravimetry.



Fig. 3. New CCB Series, Models 6177B, 6181B and 6186B Current Sources, have their positive output terminals enclosed by a guard which eliminates most of the leakage currents shown in Fig. 2. They can supply currents as low as 1 μ A, regulated within 25 ppm of setting ± 5 ppm of range for a load voltage change from zero to maximum. They also have continuously adjustable voltage limits.

regulating section, the guard circuit, the reference supply, and the voltage-limit circuit.

In the current regulating section are a series regulator, current-sampling resistors, and a current comparison amplifier. The current-sampling resistors are low-noise, low-inductance, low-temperature-coefficient resistors, large enough to give adequate voltage drop, yet as small as possible to minimize the temperature rise that results from the power dissipated in them.

The command input to the current comparison amplifier is a negative voltage with respect to the circuit common. To increase the output current the command voltage is made more negative, permitting the output current to increase until the voltage drop in the current-sampling resistors equals the input command signal. The current comparison amplifier then regulates the output current to maintain it at the selected level.

The command voltage is derived from the internal reference supply. The same command voltage is used on all three current ranges, and the output current range is changed by switching the value of the current-sampling resistors. This method of changing current range not only simplifies control but also changes the loop gain so as to improve regulation and noise rejection at low output current levels.

The current source can also be programmed externally by voltage or resistance. In this case the external voltage or resistance is used to control the command voltage.

A unique feature of the CCB Current Sources, com-

pared with most other electronically regulated power supplies, is that CCB sources have no reactive elements in the output circuit. An inductor in the output circuit would form an L/R time constant with the load which would lower the programming speed and make it dependent upon the load impedance. The effects of a capacitor have already been mentioned, and will be discussed further in the next section.

High Output Impedance

The high output impedance of the CCB Current Sources is a result of several factors, both electrical and mechanical. The series-regulator transistors are in a cascode configuration, which inherently has a high output impedance. Since the open-loop gain of the error amplifier is high, the closed-loop output impedance is greatly increased by feedback. Minimizing the output capacitance was a major design objective, and no physical capacitor has been placed across the output. Although the output impedance falls off with frequency due to the necessary gain and phase compensation in the amplifier circuits, it is much higher than it would be if a capacitor were connected across the output terminals, and much higher than it would be for a different series-regulator configuration.

The importance of low output capacitance should not be underestimated. Excessive output capacitance would cause the output impedance of the current source to fall off with increasing frequency, and this would cause undesirable transients in rapidly changing loads. Large capacitors store large amounts of energy which, if discharged suddenly through the load, may cause damage; negative-resistance devices are particularly susceptible to this kind of damage. Finally, an output capacitor would slow down the response of the current source to changes in the external programming signal. The output capacitance of the CCB Current Sources ranges from only 10 pF to 0.05 μ F, depending upon the model and the current range.

Also in the interests of keeping the output impedance high, the impedances of internal leakage paths have been made as high as possible by careful mechanical design and hygienic construction techniques. For example, the series regulator is isolated from the chassis by a layer of boron nitride which has an extremely high insulation resistance.

Leakage, both internal and external, is further reduced by guarding the positive output terminal.

How the Guard Works

Guarding techniques are often used to reduce unwanted currents flowing into or out of sensitive circuits. The operation of a guard depends on the fact that the

unwanted currents are flowing through some impedance to get into or out of the sensitive circuit. By carefully surrounding the sensitive circuit with a conducting surface or guard, each of the impedances between the sensitive circuit and the outside world can be split into two parts, one between the guard and the sensitive circuit and one between the guard and the rest of the world. If now the voltage between the guard and the sensitive circuit is kept at zero, then the guard has accomplished its purpose of eliminating unwanted currents flowing into or out of the sensitive circuit. The guard is not connected directly to the sensitive circuit; if it were then no improvement would result.

To eliminate leakage currents in the CCB type of current source, the positive output terminal is surrounded by a conductor which is connected to the front-panel guard terminal (see Fig. 5). The current comparison amplifier keeps the guard terminal and the positive output terminal within one millivolt of each other for any load or output setting. Thus any leakage impedance con-

nected to the positive output terminal has nearly zero volts across it, and leakage currents are forced to flow through the guard instead of the positive output terminal.

Leakage in long load leads can be effectively reduced with the help of the guard when the negative side of the load is grounded. Shielding the positive load lead and connecting the shield to the guard terminal is all that is required — the ground lead does not have to be shielded.

In addition to eliminating leakage currents the guard can also be used to measure the output voltage without drawing current away from the load. Connecting a voltmeter between the negative output terminal and the positive output terminal will lower the output impedance, but a voltmeter connected between the negative output terminal and the guard has no effect on the output impedance. The meter still measures the output voltage because the guard is at the same potential as the positive output terminal. The front-panel voltmeter is connected to the guard, but if accuracy greater than 2% of full scale is needed, an external voltmeter must be used.

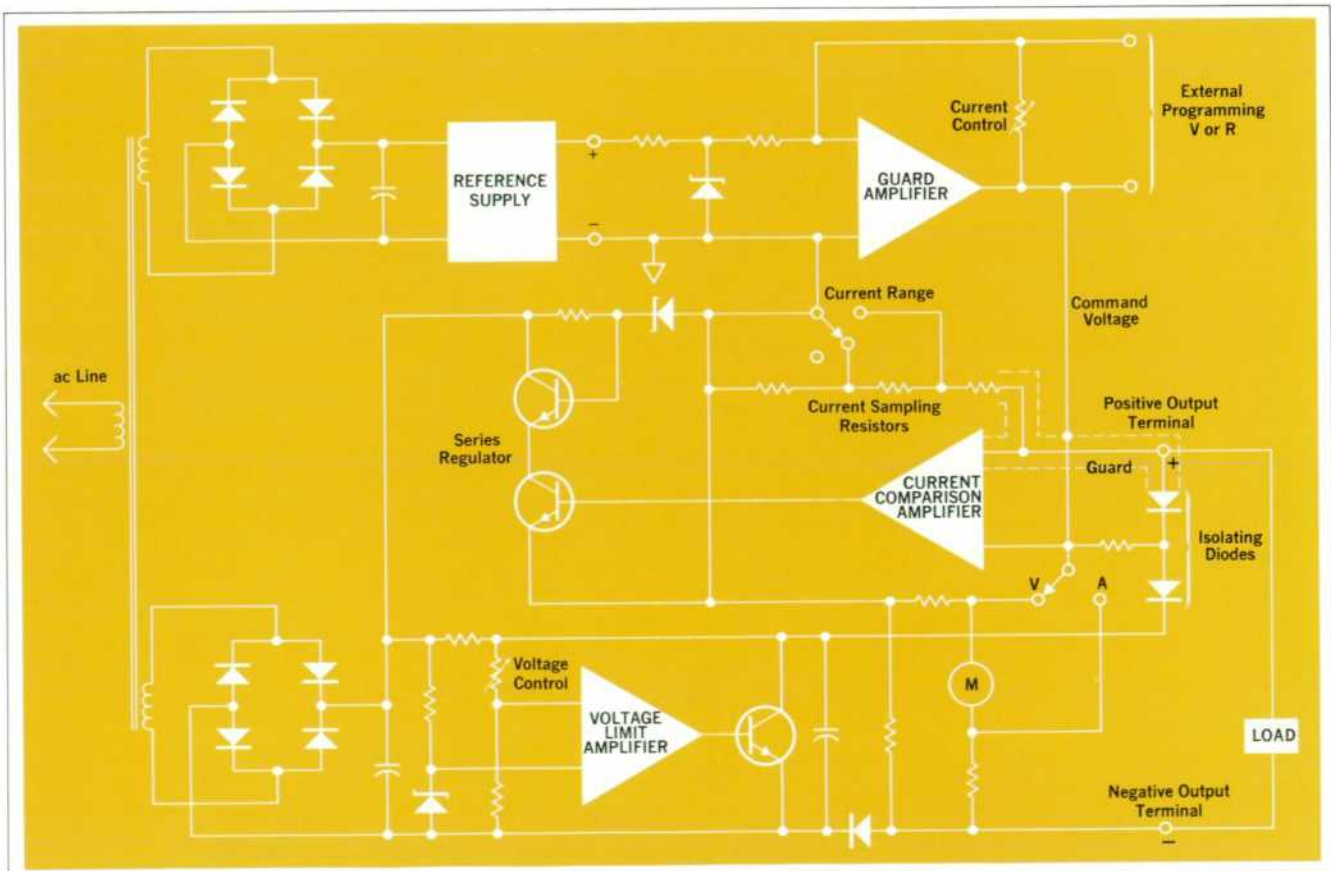

Fig. 4. Command voltage for current regulator comes from internal reference supply or from external programming voltage or resistance. Voltage-limit circuit quickly draws current away from load when load voltage exceeds voltage limits and isolating diodes turn on. High-gain regulator and absence of reactive elements in output give high output impedance, fast programming, and freedom from current overshoots.

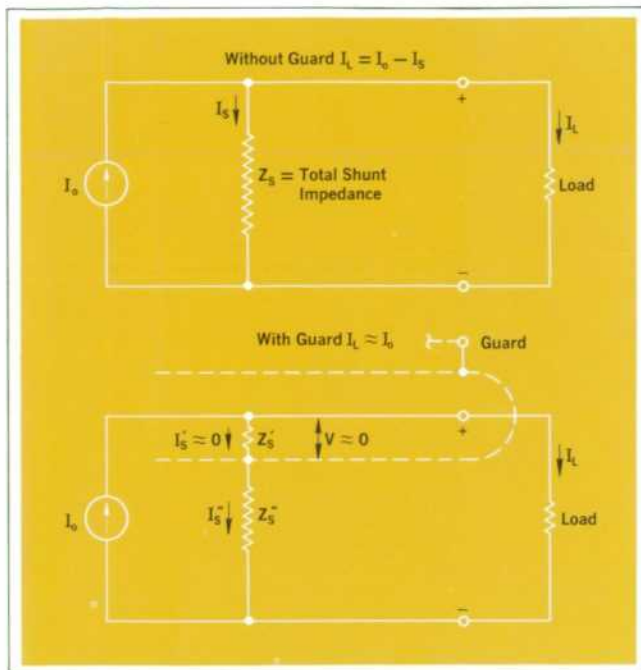

Fig. 5. The guard surrounding the positive output terminal splits the impedances through which leakage currents (I_s) flow. The guard and the positive output terminal are kept at the same voltage, thereby keeping the leakage currents from degrading the regulation. The output voltage can be measured at the guard so the meter impedance doesn't shunt the load.

Unlike other guards, such as those used on digital voltmeters, the guard in the CCB Current Source is active and internally referenced to the positive terminal. *It must not be connected to either output terminal, since this interferes with the closed loop performance.*

Voltage-Limit Circuit

The voltage-limit circuit keeps the output voltage of the current source from exceeding the level set by the front-panel voltage potentiometer. This circuit is a shunt regulator across the output terminals which draws current away from the load when the output voltage exceeds the preset level. It is capable of sinking the full rated output current of the source.

An important design criterion for the voltage-limit circuit was that it eliminate dangerous high-voltage or high-current transients that might occur under certain load conditions. For example, when the load is suddenly removed from an ordinary constant-current power supply, the output voltage will try to rise to the raw supply voltage of the instrument, which can be hundreds of volts. Or, when the load is suddenly reconnected to a unit operating in the voltage-limit mode, a high-current transient can occur if the current regulator saturates while the

instrument is in voltage limit.

In the CCB Current Source, the voltage-limit circuit always operates at the selected voltage and begins to draw load current when the load voltage exceeds this voltage and causes two isolating diodes to turn on (see Fig. 4). The voltage-limit circuit goes into operation in as little time as it takes to turn on the two isolating diodes. Because of the finite response time of the rest of the voltage-limit circuit, small voltage overshoots can occur if the load voltage is rising rapidly, but these are never more than a few volts.



Joseph C. Perkinson

Joe Perkinson received his BSEE degree from Massachusetts Institute of Technology in 1964, and came to HP the same year. Joe was the principal developer of the 6177B and 6181B Current Sources; he holds a patent on the guard circuit and has another pending on the voltage-limit circuit. Now a project engineer in the digital products group of HP's New Jersey Division, Joe is working

part-time for his MSEE degree at Stevens Institute of Technology.

In his spare time Joe often takes a busman's holiday and works on electronics projects at home. He also enjoys building and flying model aircraft and working with a church youth group.



Willis C. Pierce, Jr.

Before coming to HP in 1968, Bill Pierce worked on welding processes, equipment, and circuits for ten years, starting as a customer service engineer and gradually moving into development and research. He has four patents pending, two on new welding processes, one on a pulse-welding power supply, and one on a semiconductor diode circuit. At HP's New Jersey Division, Bill has worked

on a high-current power supply, and on the 6177B and 6181B Current Sources. He is now project engineer for the 6186B Current Source.

Bill received his bachelor's degree in engineering from California State Polytechnic College in 1959, and his MSEE degree from Stevens Institute of Technology in 1967. He is a member of IEEE. An avid tennis player, he also enjoys bridge, swimming, electronics, and working with young people through the YMCA.

The reason for using two isolating diodes is to minimize leakage. The diode connected to the positive output terminal is also connected to the guard, through a small resistor. When the diodes are turned off, this diode has very little back bias and its leakage current is negligible.

Current overshoots are minimized by having the current regulator operate normally whether it is supplying the load or the voltage-limit circuit or both. Thus there are no significant current overshoots at any time.

A front-panel light tells the user when the voltage-limit circuit is drawing current away from the load. The front-panel meter always indicates the total current being supplied by the current regulator; thus the user can set the current source to the desired current even with the output terminals open—there is no need to short the output.

Transformer Shielding Eliminates Ripple

The CCB Current Sources meet their low ripple specifications regardless of which output terminal, if either, is connected to earth ground. High-gain current regulation is one reason for the low ripple. Another is special shielding to keep ac voltages in the power transformer from being coupled into the output via the capacitance be-

tween the transformer windings and the output or ground. One source of ripple current is capacitive coupling between the primary winding and the negative output terminal. In the CCB Current Sources, this problem is eliminated by enclosing the primary winding in an electrostatic shield which is connected to earth ground. A second source of ripple current is capacitive coupling between the secondary winding and ground. In fact, much of this capacitance may be due to the primary shield. To eliminate this ripple current, the secondary winding is enclosed in an electrostatic shield which is connected to the negative output terminal. This causes the ripple current generated by the secondary winding to flow in a closed loop inside the instrument.

Acknowledgments

We would like to thank engineering manager Johan Blokker for his continuing encouragement as well as his many helpful comments and suggestions. We also want to thank John B. Leber for his efforts in mechanical layout, packaging, and printed circuit board layout; Paul J. Hartung for building and troubleshooting the prototype units; Mauro N. DiFrancesco, our group leader; and the many other people who have contributed to the project.

SPECIFICATIONS					
HP CCB-Series dc Current Sources					
Model		6177B	6181B	6186B	
Output Current		0-500mA	0-250mA	0-100mA	
Voltage Compliance		0-50Vdc	0-100Vdc	0-300Vdc	
Output Ranges	A	0-5mA	0-2.5mA	0-1mA	
	B	0-50mA	0-25mA	0-10mA	
	C	0-500mA	0-250mA	0-100mA	
Constant Current Remote Programming	Voltage Control (Accuracy: 0.5% of output current, .04% of range.)	Range A	200mV/mA	1V/mA	10V/mA
		Range B	20mV/mA	100mV/mA	1V/mA
		Range C	2mV/mA	10mV/mA	100mV/mA
	Resistance Control (Accuracy: 1% of output current, .04% of range.)	Range A	400Ω/mA	2kΩ/mA	10kΩ/mA
		Range B	40Ω/mA	200Ω/mA	1kΩ/mA
		Range C	4Ω/mA	20Ω/mA	100Ω/mA
Output Impedance (R in parallel with C)*	Range A	R = 330 Meg, C = 500pF	R = 1330 Meg, C = 10pF	**	
	Range B	R = 33 Meg, C = 0.005μF	R = 133 Meg, C = 100 pF	**	
	Range C	R = 3.3 Meg, C = 0.05μF	R = 13.3 Meg, C = 1000pF	**	
Ripple and Noise: rms/p-p (dc-20MHz)	Range A	0.40μA rms/5μA p-p	0.20μA rms/0.5μA p-p	50nA rms/**	
	Range B	4.0μA rms/40μA p-p	2.0μA rms/7.5μA p-p	0.5μA rms/**	
	Range C	40μA rms/250μA p-p	20μA rms/100μA p-p	5μA rms/**	
Meter Ranges (Accuracy 2% of full scale)		6, 60, 600mA; 60Vdc	3, 30, 300mA; 120Vdc	1.2, 12, 120mA; 360Vdc	

*This network is a simplified representation of a complex network. The formula $Z = R \times C \sqrt{R^2 + X^2}$ is used for frequencies up to 1MHz by substituting the values given for R and C. Above 1MHz the output impedance is greater than the formula would indicate — load transient overshoots are less than 20% of range setting for a full load change with a 1μs rise time.
 **Not available at press time.

AC INPUT: 115 Vac ±10%, 48-63 Hz, 0.6 A, 55 W at 115 Vac. For 230 Vac order Option 28.

LOAD REGULATION: less than 25 ppm of output ±5 ppm of range switch setting for a load change from zero to maximum rated output voltage.

LINE REGULATION: less than 25 ppm for a change in the line voltage from 103.5 to 126.5 Vac (or 126.5 to 103.5 Vac) at any output current and voltage within rating.

LOAD TRANSIENT RECOVERY TIME: less than 200 μs for output current recovery to within 1% of the nominal output current following a full load change in output voltage.

PROGRAMMING SPEED: less than 500 μs from zero to 99% of programmed output current, with a resistive load (1ms for 6186B).

TEMPERATURE COEFFICIENT: output change per degree C is less than 75 ppm of output current +5 ppm of range switch setting.

STABILITY: less than 100 ppm of output current +25 ppm of range switch setting. Stability is measured for eight hours after one hour warm up under conditions of constant line, load, temperature, and output setting.

RESOLUTION: 0.02% of range switch setting.

TEMPERATURE RATING: Operating: 0 to 55°C. Storage: -40 to +75°C.

PRICES: Model 6177B, \$425.00, Model 6181B, \$425.00, Model 6186B, \$450.00.

MANUFACTURING DIVISION: NEW JERSEY DIVISION
 100 Locust Avenue
 Berkeley Heights, New Jersey 07922

HEWLETT-PACKARD JOURNAL SEPTEMBER 1969 Volume 21 • Number 1

TECHNICAL INFORMATION FROM THE LABORATORIES OF THE HEWLETT-PACKARD COMPANY PUBLISHED AT 1501 PAGE MILL ROAD, PALO ALTO, CALIFORNIA 94304
 Editor: R. H. Snyder Editorial Board: R. P. Dolan, H. L. Roberts, L. D. Shergalis
 Art Staff: John C. Allen, Clayton Associates, Director; Marid J. Jordan, Assistant