

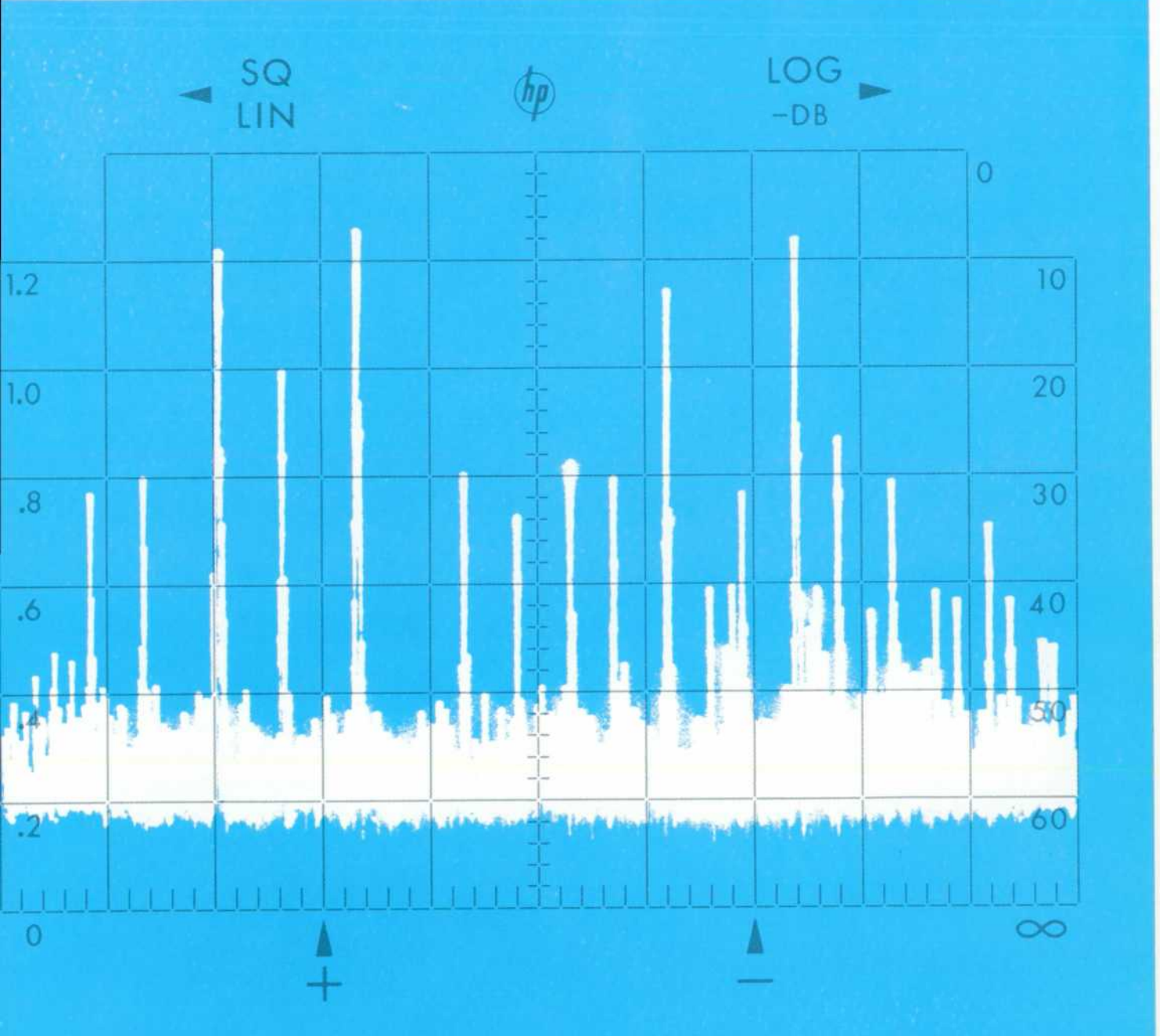

HEWLETT-PACKARD JOURNAL

TECHNICAL INFORMATION FROM THE -hp- LABORATORIES

ATE OFFICES • 1501 PAGE MILL ROAD • PALO ALTO, CALIFORNIA 94304 • VOL. 17, NO. 7 MARCH, 1966



COVER: LOW-FREQUENCY
RFI MEASUREMENTS, page 12

A MICROVOLT-SENSITIVITY FLOATING
DC VOLTMETER, page 2

TRANSFERRING STANDARD DC VOLTAGES, page 7

A SENSITIVE, WIDE RANGE DC NULL VOLTMETER WITH AN INTERNAL BUCKING SUPPLY FOR ZERO LOADING ERROR

A floating, high-sensitivity DC Null Meter measures voltages to below 1 microvolt and achieves virtually infinite input impedance with a bucking supply.

THE MINIMUM SIGNAL that can be measured with precision by a sensitive electronic dc voltmeter is determined by noise. The noise causes needle fluctuations which result in reading uncertainties. Hence, among other considerations, the design of a sensitive voltmeter is concerned with the minimization of noise, an effort that is concerned primarily with optimization of the input amplifier for lowest noise performance.

A related problem resulting from increased sensitivity in a voltmeter is drift, which affects reading accuracy. The effects of dc drift in the amplifier itself can be eliminated by the use of chopper stabilization. Drift caused by thermal emf's, which assume major importance in the microvolt region, is reduced by using only one type of metal, usually solid copper, for the input circuitry including the input terminals.

Other problems in sensitive measurements are created by ac signals superimposed on the dc signal to be measured, since the ac is quite often

much larger than the dc signal in microvolt measurements. If the ac signal is phase coherent with the chopper frequency, it is converted into a dc voltage, causing reading errors. Superimposed signals which are not phase-coherent usually do

not develop a dc offset, provided that the ac does not have sufficient amplitude to saturate the amplifier.

A NEW, SENSITIVE DC VOLTMETER

The problems caused by noise, drift, and superimposed ac have all been carefully considered in the design of a new high-sensitivity dc voltmeter. As a result, the new instrument has minimal noise, virtually no drift, and high rejection of superimposed ac voltages. The combination of residual noise level and sensitivity is such that needle fluctuations on the most sensitive range are seldom greater than 1 minor scale division above and below nominal (Fig. 3). Further, this is a scale which has an end calibration of $3 \mu\text{V}$. It is thus entirely practical to resolve dc voltages to below $0.5 \mu\text{V}$ with the new voltmeter. At the same time, dc drift is less than $0.5 \mu\text{V}$ per

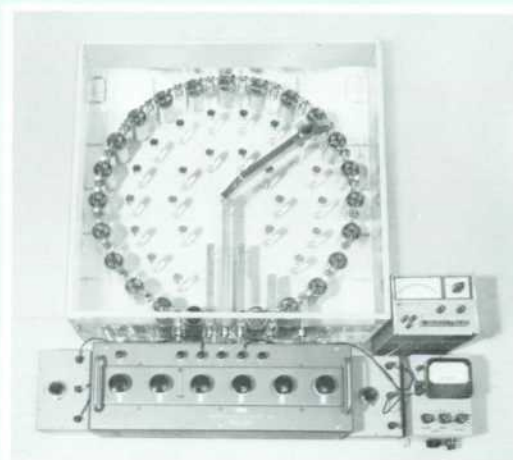

Fig. 1. DC Null Voltmeter is part of standards lab set-up for calibrating universal ratio sets, volt boxes, and Kelvin-Varley voltage dividers. Voltmeter indicates difference, if any, between steps on ratio set and corresponding steps on precision divider in temperature-stable oil bath. Precision divider is composed of new -hp- standard resistors, to be described in forthcoming article. High stability and sensitivity in high impedance circuits make DC Null Voltmeter well-suited for standards lab applications of this type. Maximum voltmeter resolution as null indicator approaches $0.1 \mu\text{V}$ and full scale sensitivity is $3 \mu\text{V}$.



Fig. 2. -hp- Model 419A DC Null Voltmeter has 18 measuring ranges from $3 \mu\text{V}$ end scale to 1000 V end scale. Pushbuttons select operating mode. Voltmeter operates from ac line power or from rechargeable internal batteries.

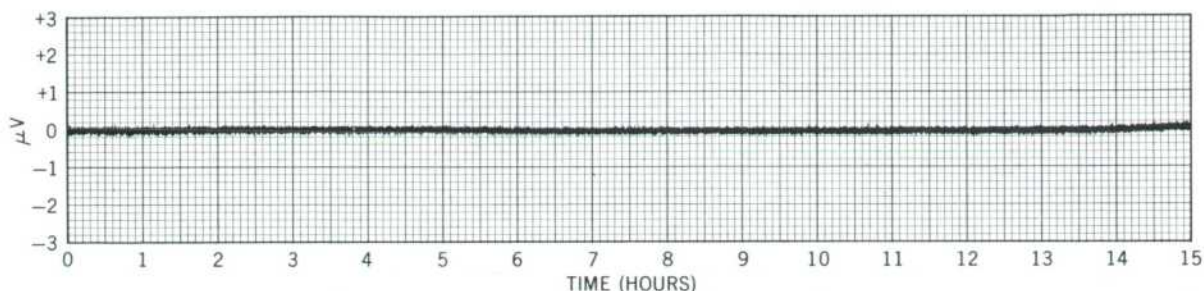

Fig. 3. Typical low noise and high stability of -hp- Model 419A DC Null Voltmeter on 3- μ V range are shown in this recording made at voltmeter output terminals with voltmeter input shorted. Peak-to-peak amplitude excursion here rarely exceeds 0.2 μ V (referred to input). During 15-hr. period shown, drift is less than 0.1 μ V.

day, while superimposed hum pickup is attenuated by at least 80 dB.

As a further factor of importance in low level measurements, the voltmeter is designed to be battery operated, permitting the instrument to be operated free of any ground loops, which also precludes common-mode voltage problems. (A built-in circuit charges the batteries when the instrument is operated on ac power.)

The new voltmeter (-hp- Model 419A) is not restricted to measurements in the microvolt region, however, since it has 18 ranges, the highest of which is 1000 volts end scale. The voltmeter is thus able to accommodate the majority of voltages encountered in the laboratory and at the same time it has the high sensitivity required for low-level measurements, such as in thermocouple, bridge, and, as shown in Fig. 4, precision calibration measurements. Accuracy on all 18 ranges of the voltmeter is 2% of end scale $\pm 0.1 \mu$ V.

Since it is important that a voltmeter have high input resistance to minimize loading errors, this factor has also received careful attention in design of the instrument. The input resistance has been made as high as is practical with due consideration to the problems arising from leakage currents and resistance noise, but in

addition, the input resistance can be made virtually infinite by use of an internal nulling voltage supply. The use of this supply permits the new voltmeter to make sensitive measurements on sources having virtually any source impedance without loading the source or causing any instabilities in the voltmeter itself. This fact makes the voltmeter potentially useful in such sensitive work as measuring biological poten-

tials or other chemically-generated and thermal emf's. Without the nulling supply, the input resistance of the voltmeter is 100 megohms on ranges above 1 volt, and it is reduced in decade steps to 100 kilohms on the most sensitive ranges.

The new voltmeter is push-button operated and has a switching arrangement that allows the input terminals to be disconnected from the internal circuits. This permits the

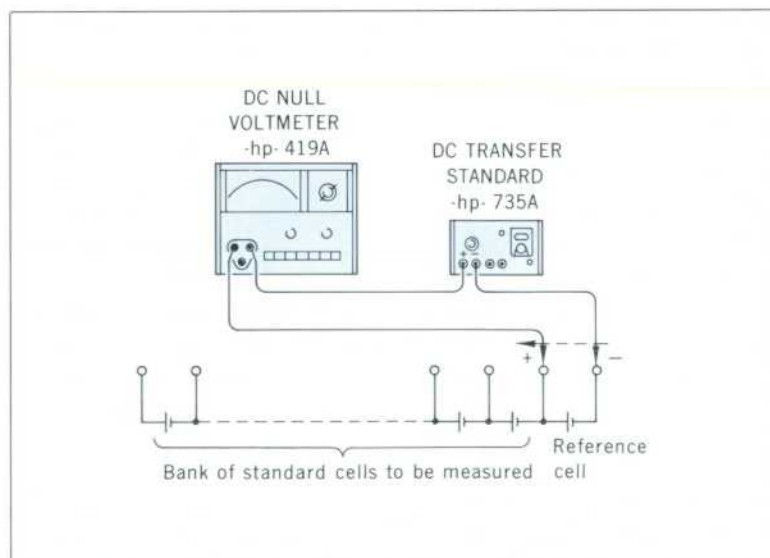

Fig. 4. DC Null Voltmeter serves here as sensitive null detector to indicate when voltage of DC Transfer Standard has been adjusted to equal standard cell voltage during standard cell comparisons. DC Null Voltmeter replaces light-beam galvanometer in calibration measurements such as this to increase sensitivity in high impedance circuits by factor of 16, besides providing 20 times faster response (meter sensitivity is 0.67 pA/mm and response time is less than 2 seconds).

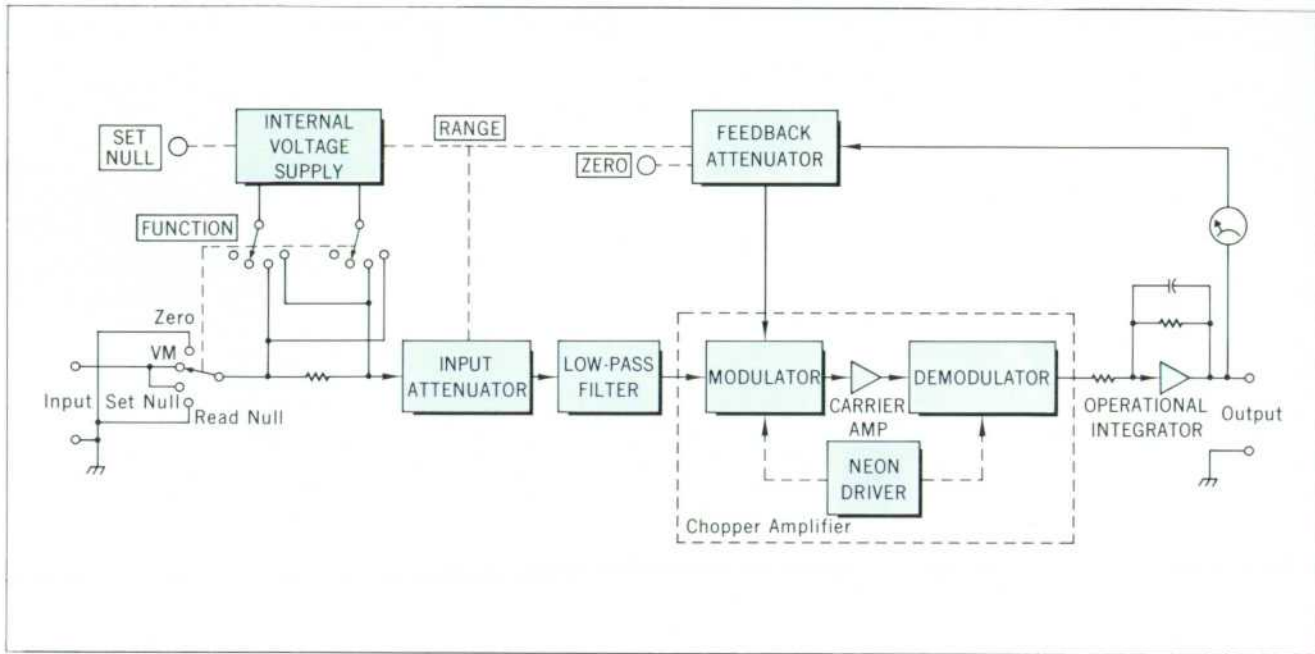

Fig. 5. Block diagram of Model 419A DC Null Voltmeter.

instrument to be connected to sensitive circuits or devices, such as standard cells, without danger of drawing current from the voltage source at the time of connection. Furthermore, the internal nulling supply can be set to match the external voltage, thus minimizing the initial current flow when the instrument circuits are switched to the input terminals.

The voltmeter is also capable of functioning as a picoammeter for measurements of small leakage currents in solid-state circuitry or vacuum-tubes. Full-scale deflection on the most sensitive range is obtained by a current of only 30 picoamperes (micro-microamperes), using the input resistance as a current shunt. Currents up to 30 nanoamperes are easily measured this way and larger currents can be measured with external shunts. The high sensitivity of the voltmeter allows low values of shunt resistance to be used to keep the series voltage drop very small.

CIRCUIT DESCRIPTION

A block diagram of the new voltmeter is shown in Fig. 5. The mod-

ulator converts the dc to an ac, using a photoconductive chopper. The resulting square wave is amplified in the six-stage, high-gain carrier amplifier and is restored to dc in the photoconductive demodulator. An overall drift rate of less than $\frac{1}{2} \mu\text{V}$ per day (referred to the input) has thereby been achieved in the instrument.

The frequency of the chopper is non-synchronous with 60-cycle line frequencies to reduce dc offsets from ac pick-up related to the power line frequency. The low-pass filter reduces the possibility of amplifier saturation from superimposed hum signals. The filter is an inductance-capacitance type, rather than resistance-capacitance, to obtain high ac attenuation without increasing thermally-generated resistance noise. With the filter and the 165-Hz chopper frequency, superimposed ac voltages at frequencies of 60 Hz and higher 80 dB above end scale cause less than 2% error.

A saturable core inverter, designed for maximum efficiency to minimize power requirements,

drives the neon lamps which illuminate the photoconductors. The 'dwell time' or illumination interval was reduced to 50% of the half-cycle time to further reduce power consumption. The instrument is thus capable of operating for more than 30 hours between battery rechargings.

Selected silicon transistors, biased for less than 4 microamperes of collector current to achieve low-noise operation, are used in the low-level stages of the amplifier. To minimize input resistance noise, the input attenuator is out of the circuit on ranges below 10 mV but it attenuates the input on the higher ranges. On the ranges below 10 mV, ranging is controlled by the feedback attenuator which divides the voltage at the amplifier output rather than at the input, thus reducing thermally-generated voltages in the attenuator to negligible levels.

The ZERO control adjusts the dc voltage in the feedback path to offset any other thermally-generated voltages (pressing the ZERO push-button disconnects the amplifier input

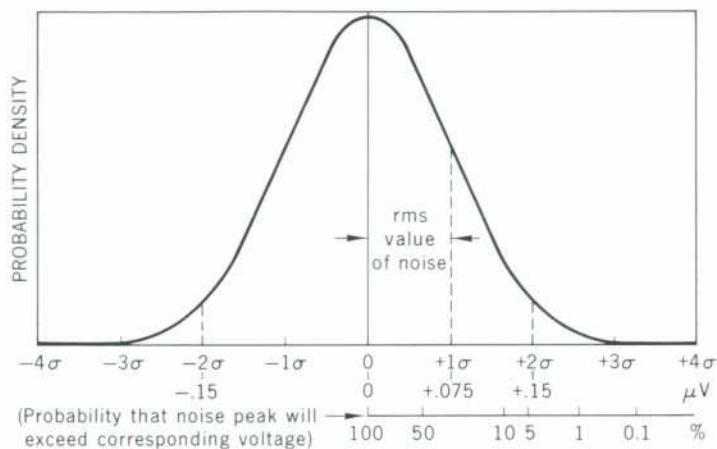

Fig. 6. Noise level on voltmeter's most sensitive range is specified as less than $\pm 2\sigma$ 95% of time; σ is standard deviation (rms noise level), assuming Gaussian amplitude distribution.

stricted bandwidth, a specification of noise in rms values is difficult to evaluate in terms of what the eye will see. Hence, a more meaningful specification would refer to the peak-to-peak reading uncertainty caused by noise.

Noise on the most sensitive range of the new DC Null Voltmeter has a Gaussian amplitude distribution, thus permitting description on a statistical basis, as shown in Fig. 6. The percentage of readings in which the noise voltage is likely to lie between two amplitude limits can be found by integrating the area under the curve between these limits. Such an analysis shows that the noise voltage will be between -2σ and $+2\sigma$ 95% of the time (σ is the standard deviation and corresponds to the rms value).

from the positive input terminal and grounds it to the 'common' terminal). The input terminals are solid copper, to eliminate galvanic voltages when connected to copper wires, and are gold-flashed to prevent corrosion.

Pressing the SET NULL push-button inserts the internal voltage supply in series opposition to the input voltage. The internal voltage can be adjusted to buck out the input voltage exactly, as indicated by a null on the meter. The source voltage is then determined after nulling by switching the meter to read the value of the internal voltage (READ NULL). The internal nulling voltage is obtained from a long-life (2000 hours) mercury battery that supplies a potentiometer network. The network is changed by the RANGE switch so that the internal voltage can always be adjusted over 120% of the voltmeter range that is selected.

The chopper-amplifier is followed by an operational integrator which provides filtering for the synchronous demodulator and which also provides additional power for driving the meter. The integrator restricts the bandwidth of the amplifier to 0.2 Hz on the $3\text{-}\mu\text{V}$ range for reduced noise. It recovers from an

overload, however, more quickly than a comparable RC filter would.

For maximum gain accuracy, the negative feedback loop extends over all of the circuitry from the meter to the amplifier input. To provide full scale meter deflection on the $3\text{-}\mu\text{V}$ range, a gain of 110 dB is required in the amplifier chain. The chopper-stabilized amplifier has a maximum gain of 96 dB and an additional 60 dB is provided by the operational integrator. This allows at least 46 dB of feedback, which is more than sufficient to prevent amplifier gain variations from affecting accuracy. The accuracy of the voltmeter is derived through the use of precision resistors in the attenuators and feedback networks.

Accuracy is additionally enhanced through the use of an individually-calibrated, tau-band meter.

Despite high sensitivity, the instrument has wide overload margins (50 V on the $3\text{-}\mu\text{V}$ to 3-mV ranges, increasing up to 1200 V on the 1-V range and above) and it recovers quickly, within 3 seconds, from a 10^6 overload.

SPECIFYING VOLTMETER NOISE

Since noise causes reading fluctuations, on the most sensitive range of a high-gain dc voltmeter with re-

DESIGN LEADER



Charles D. Platz

Chuck Platz joined the U.S. Army on finishing high school and spent 3 years as a technician at the Ordnance Guided Missile School, Redstone Arsenal. Following his tour of duty, he enrolled at Colorado State University and then joined Hewlett-Packard on completion of a BSEE degree in 1961. He subsequently obtained an MSEE at Colorado State under the -hp- Honors Cooperative Program.

In addition to the electrical design of the Model 419A DC Null Voltmeter, Chuck has contributed to the design of the Model 403B AC Voltmeter and the Model 740A DC Standard/Differential Voltmeter. He is presently at work on other instrumentation for dc standards.

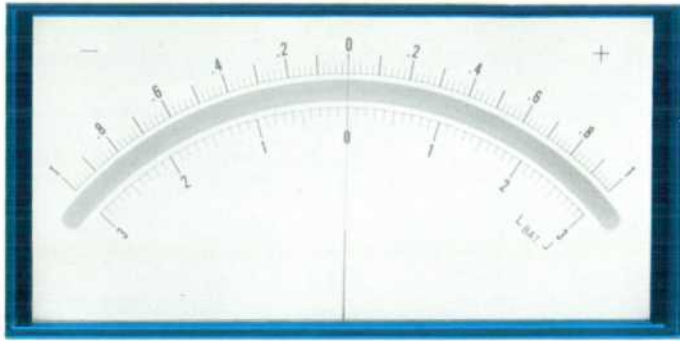

Fig. 7. Mirror-backed zero-center scale for DC Null Voltmeter is calibrated individually for each meter on *-hp-* servo-controlled meter calibrator. Meter movement is taut-band suspension type. Meter face is shown here three-fourths full size.

Accordingly, the noise in the Model 419A DC Null Voltmeter is specified as being less than a $0.3 \mu\text{V}$ peak-to-peak 95% of the time. This corresponds to an rms value of $0.075 \mu\text{V}$. Since the gain of the amplifier is reduced on the less sensitive ranges, residual noise is practically nonexistent on all but the most sensitive ranges.

RECORDER OUTPUT

The instrument also has an electrical output that is proportional to meter deflection and that is capable

of supplying up to one milliamperere at one volt. This enables the voltmeter to serve as a high impedance input, low-noise amplifier with up to 110 dB gain (depending on range) and with hum pick-up rejection of 80 dB. Input-output linearity is better than 0.5%. The voltmeter is thus useful as a preamplifier for a recorder, with the additional advantages that the internal bucking supply can serve as a convenient zero offset for the recorder and that battery operation removes the danger of ground loops.

ACKNOWLEDGMENTS

The *-hp-* Model 419A DC Null Voltmeter was developed at the *-hp-* Loveland Division Laboratories under the group leadership of Robert E. Watson. Product design was by Lawrence E. Linn and electrical design by the undersigned. The author wishes to express appreciation for the assistance and many valuable suggestions provided by Jack L. Hargens, Loveland Standards Laboratory Manager, and Marco Negrete, Engineering Manager of the *-hp-* Loveland Laboratories.

—Charles D. Platz

SPECIFICATIONS

-hp- MODEL 419A DC NULL VOLTMETER

VOLTMETER

RANGES: $\pm 3 \mu\text{V}$ to ± 1000 volts dc end scale in 18 zero center ranges.

ACCURACY: $\pm 2\%$ of end scale $\pm 0.1 \mu\text{V}$.

LIMITS OF ZERO CONTROL: $\pm 15 \mu\text{V}$.

INPUT RESISTANCE: $3 \mu\text{V}$ to 3 mV ranges: 100k ohms (infinite when nulled), 10 mV to 30 mV ranges: 1 megohm (infinite when nulled), 100 mV to 300 mV ranges: 10 megohms (infinite when nulled), 1 volt to 100 volt ranges: 100 megohms.

INTERNAL BUCKING VOLTAGE: Continuously adjustable approximately $\pm 120\%$ of end scale, $3 \mu\text{V}$ to 300-mV ranges.

RESPONSE TIME: 95% of final reading within 3 seconds on $3 \mu\text{V}$ range and within 1 second on 10- μV to 1000-V ranges.

SUPERIMPOSED AC REJECTION: 80 dB greater than end scale for ac voltages 60 Hz and above — affects reading less than 2%. Peak ac voltage not to exceed max overload voltage.

NOISE: Less than $0.3 \mu\text{V}$ p-p 95% of the time (between $\pm 2\sigma$ limits) referred to input; noise amplitude approximates Gaussian distribution with standard deviation σ (rms value) = $0.075 \mu\text{V}$.

DRIFT: $0.5 \mu\text{V}/\text{day}$ after 30 minutes warm-up.

T. C.: $.05 \mu\text{V}/^\circ\text{C}$ from 0° to $+50^\circ\text{C}$.

AMPLIFIER

GAIN: 110 dB maximum at recorder output terminals. Gain depends on range.

OUTPUT: 0 to ± 1 volt at 1 mA max. for end scale reading. Output level is adjustable for convenience when used with recorders.

OUTPUT IMPEDANCE: Depends on setting of output level control. < 35 ohms when output level is set to maximum.

NOISE: 0.01 Hz to 5 Hz — same as voltmeter; 5 Hz and above — < 10 mV rms referred to output.

GENERAL

OVERLOAD VOLTAGE: 50 Vdc max, $3 \mu\text{V}$ to 3-mV ranges; 500 Vdc max, 10-mV to 300-mV ranges; 1200 Vdc max. on 1-volt range and above.

OVERLOAD RECOVERY TIME: Meter indicates within 3 seconds following 10^\times overload.

INPUT TERMINALS: Positive and negative terminals are solid copper, gold flashed.

INPUT ISOLATION: $> 10^{10}$ ohms shunted by 250 pF. May be operated up to 500 Vdc or 350 Vac (rms) above ground.

OPERATING TEMPERATURE: 0° to $+50^\circ\text{C}$.

STORAGE TEMPERATURE: -40°C to $+60^\circ\text{C}$.

POWER SOURCE: 4 internal rechargeable batteries (furnished). Thirty-hour operation per recharge. Instrument may be operated during recharge from ac line; 115 or 230 V $\pm 10\%$, 50 to 1000 Hz, approximately 3 watts.

DIMENSIONS: Standard *-hp-* $\frac{1}{2}$ module; $6\frac{1}{2}$ in. high, $7\frac{3}{4}$ in. wide, 8 in. deep (152 x 197 x 203 mm).

WEIGHT: Net: 8 lbs. (3.6 kg). Shipping: 12 lbs. (5.4 kg).

PRICE: \$450.00.

Prices f.o.b. factory
Data subject to change without notice

A PORTABLE DC VOLTAGE STANDARD PROVIDING 10 PPM TRANSFER ACCURACY

A new type of instrument transfers precision dc voltages out of the standards laboratory to working areas.

RECENTLY DEVELOPED INSTRUMENTS—digital voltmeters in particular—now enable measurement accuracies approaching 0.01% or better in normal working environments outside of the standards lab. As with other precision instrumentation, maintaining the rated accuracy of these instruments requires periodic calibration, but calibration becomes increasingly complicated as instrument accuracy approaches that of available reference standards.

The primary reference voltage standard in most laboratories is the saturated cell. These devices have excellent long-term stability but they are sensitive to temperature as well as to physical motion and loading, and should be used with care to prevent damage. Saturated cells must be maintained in a carefully controlled environment if their potential accuracy is to be realized.

The unsaturated cell has been the preferred device for use as a working standard. Unsaturated cells are less susceptible to temperature changes

(typically 4 ppm/°C) but exhibit greater change of voltage with time, typically 2-5 ppm/month. Unsaturated cells therefore must be returned to the standards lab periodically for calibration.

When standard cells are used for the calibration of other equipment, the cell voltage, which is usually within 1.018 to 1.020 volts, is translated to a decade level, i.e., 1 V, 10 V and so on. This requires a time-consuming procedure involving some calculations and the use of precision resistive dividers and null indicators.

THE ELECTRONIC TRANSFER STANDARD

In a major step toward simplifying the transfer and translation of reference voltages from laboratory standards to comparison equipment outside the standards laboratory, a new kind of instrument has been developed (Fig. 1). Basically, the new instrument consists of a highly stable voltage source and built-in precision resistive dividers (Fig. 2). To assure a high level of accuracy, the instrument was designed to have a stability of 1 to 2 ppm/8 hours, and an overall temperature coefficient of less than 1 ppm/°C, four times better than that of the unsaturated cell. Nevertheless, the new DC Transfer Standard is a rugged device, insensitive to orientation, and easily moved from place to place.

The new instrument was designed primarily for the convenient translation of a standard cell voltage to 1.000 volt for the calibration of precision instruments. It has the high stability and low temperature sensitivity required for accurate voltage intercomparisons (Fig. 3). Besides serving as a reference standard for the calibration of instruments hav-

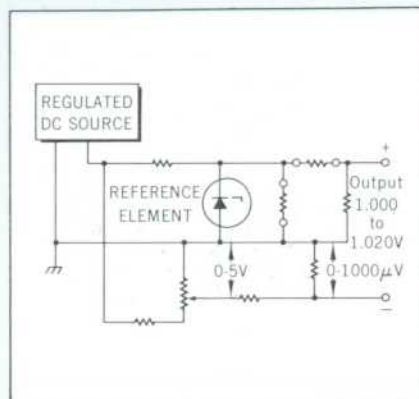

Fig. 2. Basic elements of *hp-Model 735A DC Transfer Standard*. Stable reference voltage derived from precision reference diode is divided down in switched resistor networks to obtain output voltages.

ing rated accuracies up to 0.001%, the new instrument may also be used as a standard cell comparator and as a stable working voltage source on the production line or in the lab.

Other uses for the DC Transfer Standard include the ratio-matching of series strings of resistors to better than 1 ppm and service as a voltage source for decade dividers, potentiometers, or other devices requiring an extremely stable voltage reference.

VOLTAGE OUTPUTS

Two of the switch-selected output voltages of the new instrument are chosen to match the voltages of standard cells, 1.018 volts for saturated cells and 1.019 volts for unsaturated cells.* These voltages are adjustable with a calibrated precision potentiometer over a range of 1000 μ V to provide voltage resolution to 6 decimal places.

A third switch position selects the divider that produces a fixed 1.000

* Voltage dividers yielding 1.017 volts have been designed for instruments to be used in comparisons with standard cells maintained at elevated temperatures.

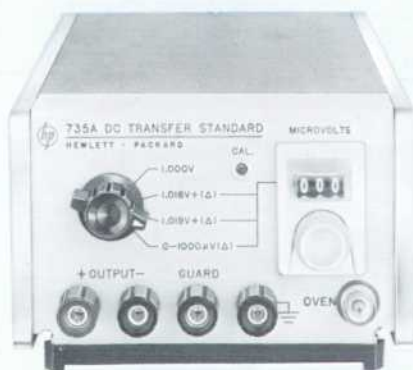

Fig. 1. *hp-Model 735A DC Transfer Standard* supplies any one of four highly-stable switch-selected voltages to floating and guarded output terminals. Instrument is portable but has stability within 1 or 2 ppm per 8 hours. Temperature coefficient is less than 1 ppm/°C.

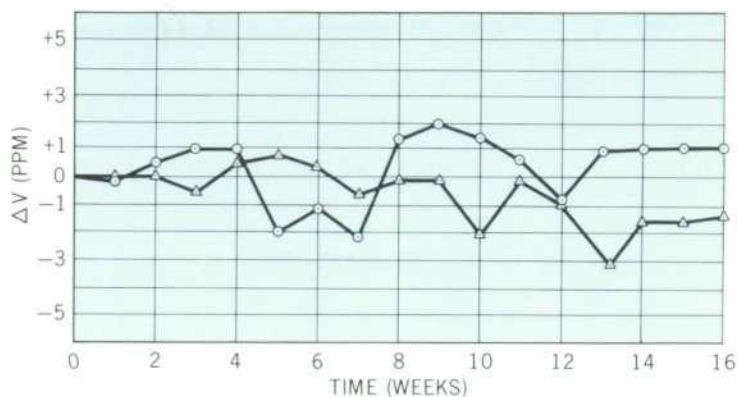

Fig. 3. Typical long-term stability of Model 735A DC Transfer Standard. Graphs show outputs of two Model 735A's referenced to standard cell that has stability of about 1 ppm/year. During period of test, DC Transfer Standards were in 25°C environment subject to normal room temperature variations of $\pm 2^\circ\text{C}$.

V, without the provision for incremental voltage adjustment. The fourth switch position selects the potentiometer voltage alone, thus permitting the instrument to serve as a stable microvolt source with a range of 0–1000 μV .

USING THE DC TRANSFER STANDARD

The new DC Transfer Standard is quickly calibrated in the Standards Lab using the set-up shown in Fig. 4. The calibration procedure begins by setting the OUTPUT control to $1.018 + \Delta$ (or $1.019 + \Delta$ if calibration is made with unsaturated cells) and dialing the last three places of the standard cell certification into the MICROVOLT

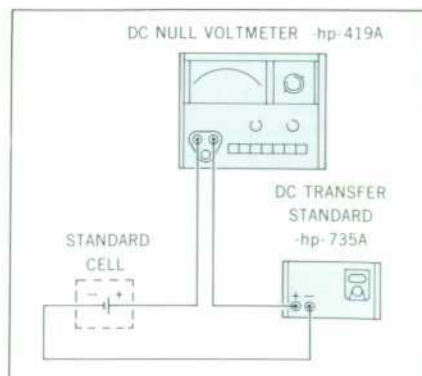

Fig. 4. DC Transfer Standard is quickly calibrated using standard cell and -hp-Model 419A DC Null Voltmeter. Voltmeter indicates by null that Transfer Standard output is adjusted to equal standard cell voltage (see text).

control, e.g., a standard cell certification of 1.018432 volts requires that the switch be set to $1.018 + \Delta$ and that 432 be dialed into the MICROVOLT control.

The Null Meter is then switched into the circuit to indicate the difference, if any, between the standard cell voltage and the DC Transfer Standard output. A recessed screwdriver control on the front panel allows the output of the DC Transfer Standard to be adjusted to equal the standard cell voltage, as shown by a null on the meter.

The DC Transfer Standard is thus referenced to the standard cell and is ready for intercomparing other standard cells, or for calibrating unsaturated cells, or for translating the reference standard cell accuracy to a 1-volt level for instrument calibrations (see Fig. 5). The Transfer Standard can be unplugged from the power line and taken to another area where it will be ready for use after a short warm-up interval. As shown in the diagram of Fig. 6, the DC Transfer Standard recovers typically to within ± 1 ppm in 30 minutes following a long power interruption. Recovery takes less than 10 minutes if the power is off for less than 5 minutes.

Following calibration of the DC Transfer Standard, other standard

cells can be compared to the first standard cell, again by using the set-up shown in Figure 4. In this case, the MICROVOLTS control is adjusted to achieve a null on the meter. The last three decimal places of the cell voltage are then read directly. The DC Transfer Standard achieves a transfer accuracy of 2 ppm when intercomparisons are made between similar types of standard cells and intercomparisons between saturated and unsaturated cells have a transfer accuracy typically better than 5 ppm. The transfer accuracy to 1 volt is within 10 ppm.

CIRCUIT CONSIDERATIONS

To achieve a stability of 1 or 2 ppm per 8 hours and an overall temperature coefficient of better than 1 ppm/ $^\circ\text{C}$, the zener diode that serves as the precision reference source and associated circuitry are housed in a proportionally-controlled oven. The internal oven temperature is held

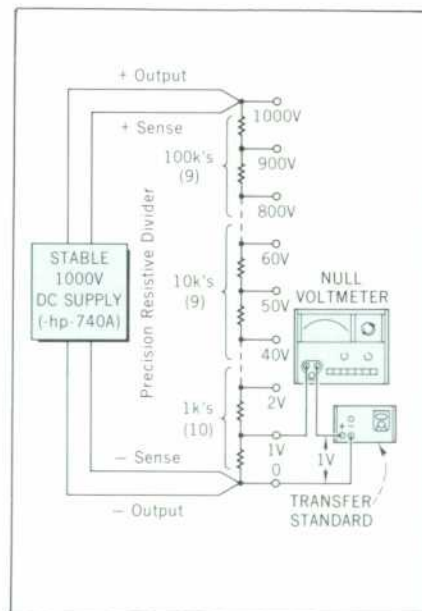
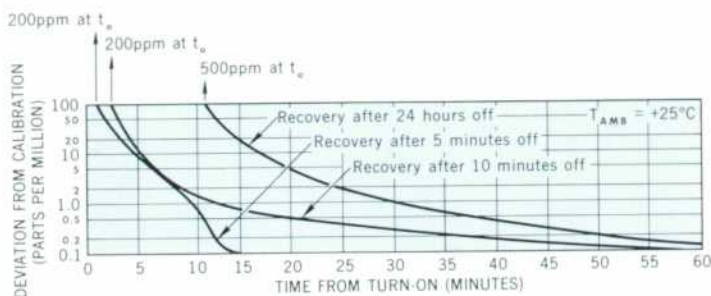

Fig. 5. Resistive divider that serves as precision source of voltages from 1 to 1000 volts is calibrated by adjusting voltage supply to show null between calibrated 1-volt output of DC Transfer Standard and 1-volt tap on precision divider. Divider voltages are then accurate within accuracy of divider ± 10 ppm transfer accuracy of DC Transfer Standard.

Fig. 6. Typical recovery of DC Transfer Standard after restoration of ac power following power interruption.



nominally at 80°C with excursions of less than $\pm 0.10^\circ\text{C}$ during normal room temperature variations. Critical circuits in the temperature control system are also housed in the oven to obtain maximum temperature stability. A front panel pilot light glows in proportion to the amount of power supplied to the oven heater and thus shows by dimming when the oven has reached operating temperature.

Critical resistors are wound from the same spool of wire to obtain the best possible match of temperature coefficients. Since the maximum range-to-range change in output voltage is only 20 mV, range-to-range accuracy is held to better than 5 ppm by maintaining the accuracy of resistors that are switched to about 0.025%. All switching takes place at the highest possible voltage levels to reduce the effects of thermal emf's and of contact impedance.

A block diagram of the instrument is shown in Fig. 7. A preregulator, controlled by a zener diode, precedes the series regulator that supplies the reference diode. The voltage taken across the reference diode is nominally 6.3 volts and it is divided down in resistive networks to obtain the output voltages.

The equivalent circuit for a zener diode at any given current level is a battery in series with a resistance, as follows:

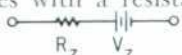

Since R_z is usually 10 to 20 ohms, the circuits must be designed to supply a constant current to the diode.

The divider circuits thus have both series and shunt elements so that each divider draws 1 mA when switched into the circuit, maintaining the load on the regulating system constant at all times. The 'Calibrate' control is a fine adjustment on the 1 mA current and it therefore calibrates all three fixed output voltages simultaneously.

The MICROVOLT incremental voltage is derived in a separate circuit to enable vernier control of the output voltage without disturbance of the current in the divider circuits. The incremental voltage is combined with the divider voltage by taking the output across the two circuits in series opposition, as shown in the diagram. (Not shown in the diagram is the switching that inverts the potentiometer output on the 0-1000 μV range to maintain output polarity.)

To reduce the effect of thermal emf's generated in the MICROVOLTS potentiometer, the voltage across the 10-turn potentiometer is made to be 5 volts, and the output at the arm of the pot is divided down by a factor of 5000. Noise on the incremental voltage is thus less than 1 μV (dc to 1 Hz) and accuracy is 0.1% $\pm 0.5 \mu\text{V}$. The potentiometer control can be locked in place by pressing the knob after being set to a particular voltage.

OUTPUT CHARACTERISTICS

As is true of standard cells, the DC Transfer Standard is not accurate if any current is withdrawn (in

calibration measurements, of course, such as in Figures 4 and 5, no current is drawn at null). Unlike standard cells, no damage can occur to the instrument if current is withdrawn, even if the output is short-circuited. The output impedance is constant at 1 k ohm enabling correction factors to be applied if the measurement necessitates some current drain from the DC Transfer Standard.

The output terminals are solid copper, to eliminate thermal voltages with external copper wiring, and are gold-flashed to prevent corrosion.



ROBERT E. WATSON

Bob Watson is a group leader in the -hp- Loveland Laboratories with responsibility for dc differential voltmeters, low-level dc voltmeters, and dc standards including the -hp- Model 740A DC Standard/Differential Voltmeter recently described in these pages.¹ Bob joined -hp- in 1961 following two years in atmospheric and ionospheric research at a university-affiliated laboratory. He holds both a BSEE and an MSEE from the University of Utah and is a member of Eta Kappa Nu, Tau Beta Pi, and Sigma Xi.

¹ Robert E. Watson, 'A Combined DC Voltage Standard and Differential Voltmeter for Precise Calibration Work,' *Hewlett-Packard Journal*, Vol. 16, No. 9, May, 1965.

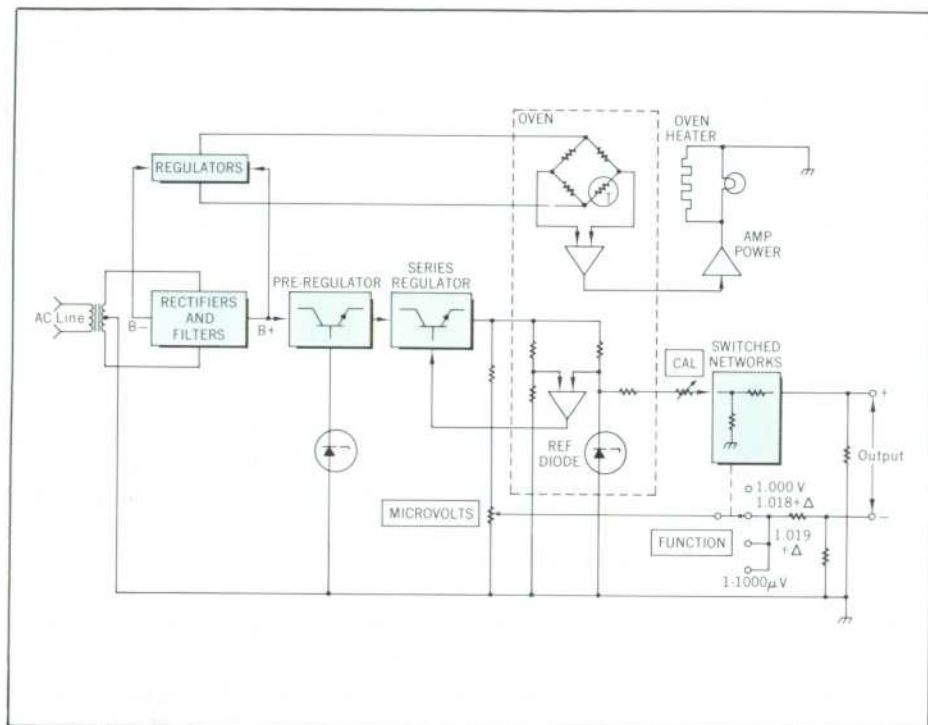

Fig. 7. Block diagram of Model 735A DC Transfer Standard. For simplicity, switch contacts that ground divider networks and invert output to preserve polarity on '1-1000 μ V' position of FUNCTION switch, are not shown.

As a further refinement, the entire circuitry is housed in an isolated guard shield. When making floating measurements, the guard may be connected to an appropriate dc voltage to increase the effective leakage resistance to ground (effectively 10^{11} ohms or higher).

ACCURACY AND STABILITY

The temperature-compensated Zener diodes used as the basic reference are selected and aged prior to assembly of the oven unit. After as-

sembly, the entire reference and oven control circuit is aged for six weeks and the total device stability is recorded during this time. A unit must exhibit a drift of less than 5 ppm/month during this time to be acceptable for use in a completed instrument. Total instrument stability is within 10 ppm/month (Figure 3).

ACKNOWLEDGMENTS

Product design on the -hp- Model 735A was performed by Laurence E. Linn and electrical design was by the undersigned. Many valuable ideas and suggestions were provided by Jack L. Hargens, manager of the Standards Lab at the -hp- Loveland Division.

—Robert E. Watson

ADJUSTMENT IN WWVB TIME PULSES

The phase of seconds pulses broadcast by National Bureau of Standards' radio station WWVB (60 kHz) are to be retarded 200 ms on March 1, 1966. This adjustment insures that the pulses, which conform to the internationally agreed-upon atomic-based one-second interval, are within 100 ms of the UT2 time scale, which is based on the rotation of the earth and which is thus subject to minor fluctuations.

There will be no change on March 1 in the phase of time pulses emitted by NBS stations WWV and WWVH, which are associated with the UT2 time scale.

SPECIFICATIONS

-hp- MODEL 735A DC TRANSFER STANDARD

STANDARD OUTPUTS: 1.00000V; 1.018 V + Δ^* ; 1.019 V + Δ^* ; 0 to 1000 μ V (Δ^*).

TRANSFER ACCURACY: (after 30 min. warmup) 2 ppm between saturated standard cells or unsaturated standard cells; 10 ppm standard cell to 1 volt; 10 ppm saturated standard cell to unsaturated standard cell (typically better than 5 ppm).

STABILITY: (after 30 min. warmup) better than 10 ppm/month.

LINE REGULATION: < 1 μ V for 10% line change.

OUTPUT IMPEDANCE: 1 k ohm \pm 1%.

SHORT CIRCUIT CURRENT: < 1.5 mA.

TEMPERATURE COEFFICIENT: < 1 ppm/ $^{\circ}$ C, 0 $^{\circ}$ C to +50 $^{\circ}$ C.

VARIABLE OUTPUT:

RANGE: 0 to 1000 μ V.

ACCURACY: 0.1% \pm 1.5 μ V.

* Δ is a 3-digit, direct-reading 0-to-1000- μ V offset voltage.

RESOLUTION: 1 μ V.

OUTPUT IMPEDANCE: 146 ohms \pm 1%.

OUTPUT NOISE: DC to 1 Hz: < 1 μ V p-p. 1 Hz to 1 MHz: < 100 μ V rms.

OUTPUT: Floating and guarded.

POWER: 115 or 230 volts \pm 10%, 50 to 1000 Hz, approximately 12 watts.

OUTPUT TERMINALS: Four 5-way binding posts. Positive, negative, circuit guard shield, and chassis ground; positive and negative terminals are solid copper with gold flash. A maximum of 500 volts dc may be connected between chassis ground and guard or circuit ground.

EFFECTIVE GUARDED CAPACITY: < 25 pF (capacity between circuit and chassis ground with shield driven).

DIMENSIONS: 3 $\frac{3}{8}$ in. high, 5 $\frac{1}{8}$ in. wide, 11 in. deep (86 x 130 x 279 mm.).

WEIGHT: Net: 5 $\frac{1}{2}$ lbs. (2.5 kg); Shipping: 8 lbs. (3.6 kg).

PRICE: \$375.00.

Prices f.o.b. factory

Data subject to change without notice

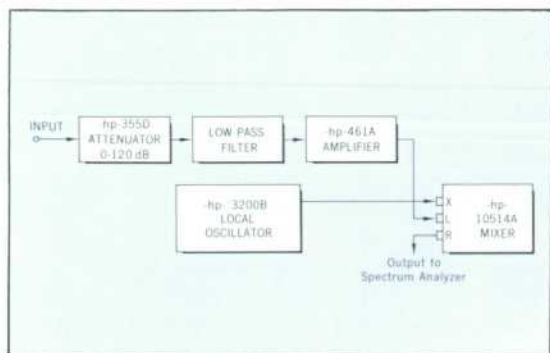

Fig. 4. Model K15-8551B Converter consists of four pieces of commercially available -hp- equipment plus filters, in combining case. 100-MHz oscillator signal is modulated by low-frequency input signals, and upper sidebands are displayed on analyzer. Mixer provides 50 dB carrier suppression.

RFI MEASUREMENTS

(cont'd from back cover)

The converter has a flat frequency response over the 10-kHz-to-10-MHz range. Fig. 3 shows the frequency response from 1 MHz to 10 MHz. Variations are less than ± 0.5 dB.

The analyzer/converter combination is 2 feet 2 inches high and weighs only 160 pounds, which makes it suitable for mobile RFI measurements in the field.

CONVERTER OPERATION

Fig. 4 is a block diagram of the new converter. It consists of four pieces of commercially available -hp- equipment, plus a low-pass filter and a power-line filter, all packaged in a combining case. The heart of the converter is a recently developed, wide-band, untuned, balanced mixer.² Acting as a suppressed-carrier modulator, the mixer combines signals from 10 kHz to 10 MHz and higher with a 100-MHz carrier signal from the local oscillator. The upper sidebands of the

modulated signal, 100.01 MHz to 110 MHz, are then displayed on the spectrum analyzer.

The balanced mixer suppresses the 100-MHz carrier signal by 50 dB, so it does not overload the input mixer of the spectrum analyzer. The suppressed carrier can still be seen on the display, and can be used to mark zero frequency.

To prevent mixer overload, which can cause distortion and erroneous measurements, the converter has an input attenuator which is variable from 0 to 120 dB in 10 dB steps. The proper attenuator setting is easily determined. Starting with 0 dB attenuation, input power is reduced in 10 dB steps. When input power is too large, each 10 dB decrease in input power will cause less than a 10 dB decrease in some of the signals on the display. When a 10 dB reduction in input power first causes all signals on the display to decrease by 10 dB, the input level is below the mixer overload level and the attenuator setting is correct.

The amplifier used in the new converter has a gain of 40 dB. The low pass filter eliminates high-fre-

quency noise and unwanted signals, and prevents mixing of high-frequency signals with harmonics of the local oscillator frequency.

LABORATORY USE

The analyzer/converter is, of course, a general-purpose spectrum analyzer that can be used for many types of frequency spectrum measurements. In laboratories it can be used to examine very low-level signals from transistor oscillators. However, the analyzer's minimum IF bandwidth of 1 kHz limits its resolution at audio frequencies, so that for applications requiring greater resolution, other instruments would have to be used. Fig. 5 shows the resolution of the 1-kHz IF bandwidth of the analyzer, both with and without a crystal-filter accessory which improves its selectivity.

CONVERTER RFI

The converter meets MIL-I-6181D RFI-susceptibility specifications when the individual components are installed in the combining case with a filter in the amplifier power line.

—John Cardoza



John Cardoza

John Cardoza received his BSEE degree from Stanford in 1956. After three years as a U.S. Air Force Communications Officer at Cape Kennedy he returned to Stanford and received his MSEE in 1962. He then joined -hp- as a sales engineer in the Corporate Sales Department, and in 1963 he transferred to the Microwave Division Sales Department. Since June, 1965, when he obtained his MBA degree by attending evening classes at the University of Santa Clara, John has been Applications Engineering Manager, Microwave Division.

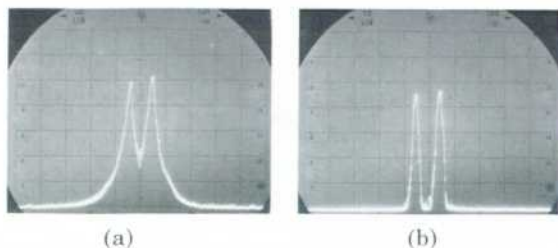

Fig. 5. -hp- Model 851B/8551B Spectrum Analyzer display of two closely spaced signals, using 1-kHz IF bandwidth. (a) shows resolution of analyzer alone. (b) shows increased selectivity obtained with -hp- Model 8442A Crystal Filter. Horizontal scale is 10 kHz/cm, vertical scale is 10 dB/cm.

² Victor E. Van Duzer, "A 200 kc/s 500 Mc/s Frequency Conversion Unit for Mixing, Modulating, Phase-Detecting and Level-Controlling," *Hewlett-Packard Journal*, Vol. 17, No. 2, Oct., 1965.

RFI MEASUREMENTS DOWN TO 10 kHz WITH SPECTRUM ANALYZER CONVERTER

ALL ELECTRICAL DEVICES generate unwanted signals, harmonics, leakage, and electrical transients, which can interfere with sensitive electronic equipment operating in any part of the electromagnetic spectrum. Because of this interference problem, U.S. government procurement agencies often specify that many kinds of electrical equipment be checked for 'radio frequency' emissions over a frequency range of almost six decades, from the upper audio frequencies (14 kHz) to the high microwave frequencies (10 GHz).^{*} In the past, such radio frequency interference (RFI) measurements had to be made with a number of receivers, each one covering a small portion of the spectrum. Shortcomings of this method were the time and equipment required, the possibility of human errors, and

^{*} Seriousness of the interference problem is indicated by bill S. 1015, now before the U.S. Senate, which would empower the Federal Communications Commission to regulate the manufacture, sale, shipment, or use of devices that create 'harmful radio frequency interference'.



Fig. 1. New -hp- Model K15-8551B Spectrum-Analyzer Up-Converter mounted on top of -hp- Model 851B/8551B Spectrum Analyzer. Analyzer range without converter is 10 MHz to 40 GHz; converter extends this down to 10 kHz.

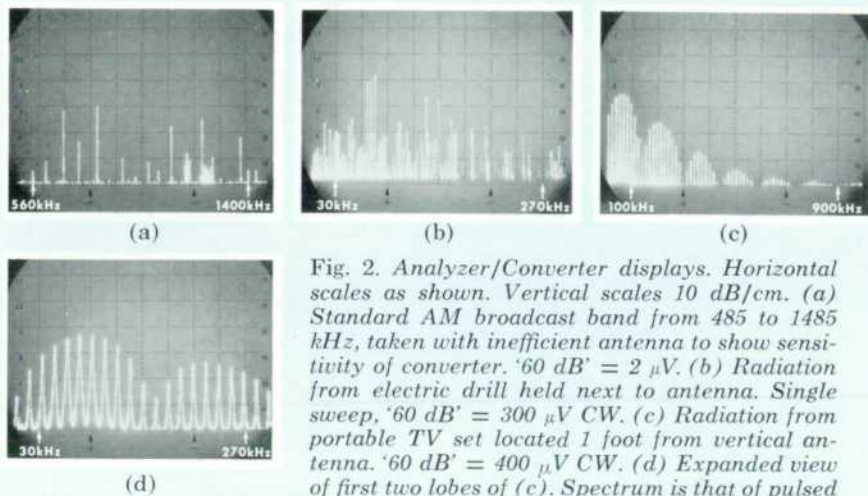

Fig. 2. Analyzer/Converter displays. Horizontal scales as shown. Vertical scales 10 dB/cm. (a) Standard AM broadcast band from 485 to 1485 kHz, taken with inefficient antenna to show sensitivity of converter. '60 dB' = 2 μ V. (b) Radiation from electric drill held next to antenna. Single sweep. '60 dB' = 300 μ V CW. (c) Radiation from portable TV set located 1 foot from vertical antenna. '60 dB' = 400 μ V CW. (d) Expanded view of first two lobes of (c). Spectrum is that of pulsed signal with repetition rate of approximately 15 kHz, indicating that radiation is coming from horizontal synchronizing circuits of TV set.

the difficulty of detecting transient phenomena.

The situation was much improved with the development of a wide-band, fully calibrated microwave spectrum analyzer.¹ This made it possible to make RFI measurements from 10 MHz to 40 GHz with a single instrument, which was also fast enough to detect the transients that older methods missed. Using a voltage-tuned backward wave oscillator as a local oscillator sweeping from 2 to 4 GHz, the analyzer has calibrated display widths of up to 2 GHz. A calibrated display range of 60 dB, and calibrated controls for IF bandwidth, sweep time, and RF and IF attenuation make the analyzer a convenient tool for general laboratory spectrum analysis, as well as for RFI measurements.

Now, with a new Spectrum Analyzer Converter, the range of this wide-band microwave spectrum analyzer can be extended down to 10 kHz, so that the entire frequency spectrum from 10 kHz to 40 GHz

can be inspected with a single instrument. Fig. 1 shows the analyzer/converter combination.

A preamplifier and a low-pass filter in the converter give the analyzer/converter a typical sensitivity of 1 μ V over the 10-kHz-to-10-MHz range. This means that a 1 μ V CW signal will have an amplitude twice the noise level, when the IF bandwidth of the analyzer is set at 10 kHz. Fig. 2a is a photograph of the analyzer display of the standard AM broadcast band at Palo Alto, California. The smallest signals are less than 1 μ V. (concluded inside on p. 11)

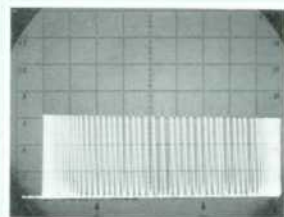

Fig. 3. Analyzer/Converter display of output of signal generator as it was tuned from 1 MHz to 10 MHz. Locations of peaks are generator frequencies on successive analyzer sweeps. Manual tuning of generator caused crowding at ends of display. Uniformity of peak heights shows that converter frequency response is flat within ± 0.5 dB.

¹ Harley L. Halverson, 'A New Microwave Spectrum Analyzer,' 'Hewlett-Packard Journal,' Vol. 15, No. 12, Aug. 1964.