



Precision Plug-In Frequency Measurements to 3000 Mc

A new plug-in converter for the -hp- high-speed counter extends the simplicity of the frequency counter up to 3000 Mc at resolutions up to 3 parts in 10^{11} .

PRECISION frequency measurements as high as 3000 Mc can now be made with a new frequency converter plug-in for the -hp- 50 Mc Counter. This 3000 Mc capability represents a significant increase in the frequency range of heterodyne converters for electronic counters. With the new plug-in, the -hp- Model 5245L Counter is now able to directly measure the frequencies of UHF

troposcatter communications systems, of microwave aircraft navigation aids, of telemetry systems in the IRIG 2.2 Gc band, and of other UHF devices.

The new plug-in, -hp- Model 5254A, uses the heterodyne frequency translation principle. This technique, in combination with a high speed counter, has been used by -hp- for precise VHF



Fig. 1. New -hp- 300 to 3000 Mc Converter being used with -hp- 5245L Counter at backscatter range facility of Micronetics, Inc., San Diego, Calif. Converter and counter are used in precisely establishing UHF, L-band, and S-band frequencies used in making radar cross-section measurements. Here, Warren T. Fey, techniques engineering manager, checks frequency of one of Micronetics' range transmitters.

SEE ALSO:
Changes in NBS Broadcasts, p. 5
Changes in Navy VLF Frequencies, p. 5
New four-channel 40 Mc scope plug-in, p. 6

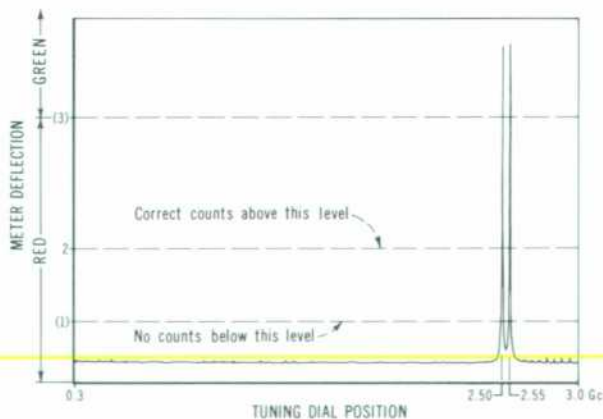

Fig. 2. Plot of output of new -hp- 3 Gc counter plug-in vs tuning dial position; plot made while frequency to be measured was applied. Two responses are desired responses from converter harmonics immediately below and immediately above measured frequency. Freedom from spurious responses is evident. Cavity selectivity has been designed to bring saddle between responses to a level far below "measure" region of plug-in's meter, thus preventing measurement errors.

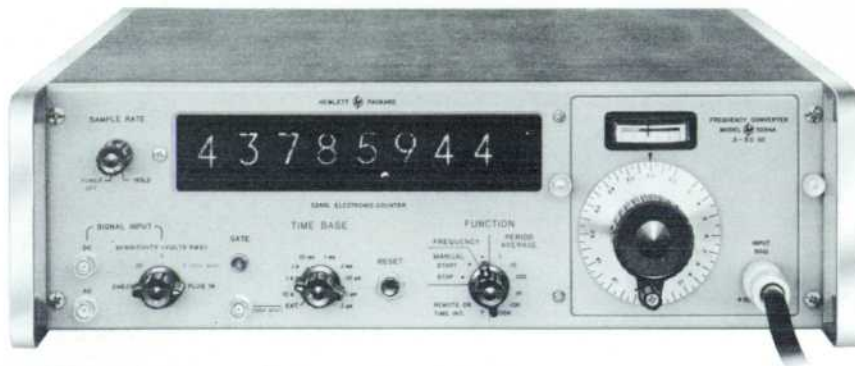

Fig. 3. Counter and new 0.3-3.0 Gc frequency converter plug-in accurately measure frequencies to 10-digit resolution. Converter dial shows two most significant digits and counter displays remainder. Counter input is available for other measurements while plug-in is in place.

frequency measurements for many years. It is an arrangement that has been widely accepted because it provides great accuracy, high resolution, and simple operation at minimum cost. The new plug-in extends these same advantages to measurements throughout the UHF band (0.3 to 3 Gc).

In operation, the plug-in subtracts a harmonic of 50 megacycles from the frequency to be measured. The difference frequency is then automatically measured by the counter. The unknown input frequency is simply the sum of the selected harmonic of 50 Mc, whose frequency is indicated on the tuning dial, and the counter reading.

The high accuracy of the 5245L Counter also applies directly to the plug-in since the 50 Mc harmonics are exact multiples of the counter's 1 Mc frequency standard. The drift rate of this internal standard is less than ± 3 parts in 10^9 per 24 hours, and the short term stability is better than ± 5 parts in 10^{10} . By choice of the counter gate time, the operator can select a measurement resolution that is appropriate for the stability of the signal being measured. The maximum resolution is ± 0.1 cps with a 10 sec gate which, for a 3 Gc input frequency, amounts to a measurement resolution of ± 3.3 parts in 10^{11} !

While the plug-in is in place, the counter can also be used for its

other functions such as measuring frequencies below 50 Mc, scaling input counts, and making period, multiple period and ratio measurements.

The new 3000 Mc Frequency Converter plug-in represents yet another development in a continuing program that keeps the *-hp-* Model 5245L 50 Mc solid-state counter abreast of growing measurement needs.

BASIC OPERATION

A block diagram of the *-hp-* Model 5254A Frequency Converter is shown in Fig. 4. The precise 10 Mc output of the counter's time base is multiplied by 5 in the con-

verter and a step-recovery diode¹ generates harmonics of the resulting 50 Mc signal. These harmonics are coupled into a resonant cavity by a small loop.

The cavity is tuned by a movable plunger to resonate on only one harmonic at a time. Fig. 5 (cavity output vs tuning dial position) illustrates that harmonic frequencies are found only at the discrete points marked on the dial, even though the tuning mechanism is a continuous control. Slight detuning affects the amplitude but *not* the frequency of a selected harmonic.

¹"A New Frequency Counter Plug-in Unit for Direct Frequency Measurements to 510 Mc." Hewlett-Packard Journal, Vol. 12, No. 5, January 1961.

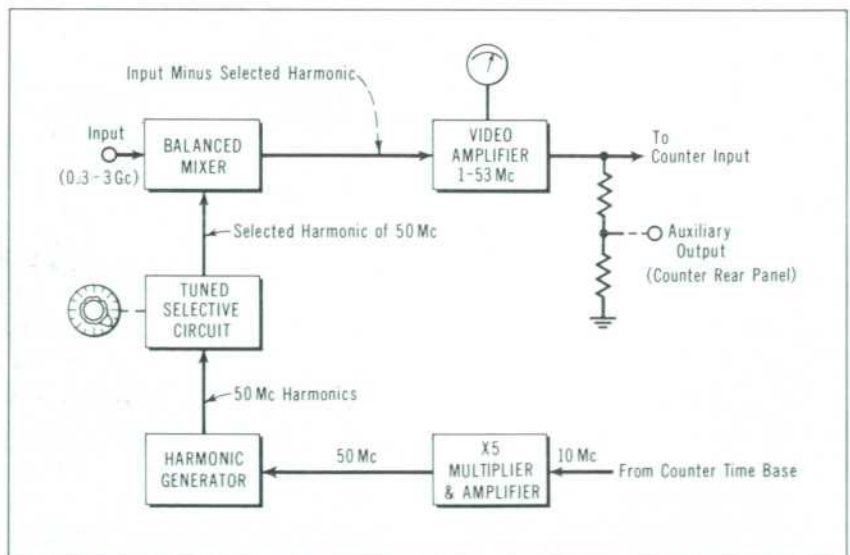

Fig. 4. Block diagram of *-hp-* Model 5254A Frequency Converter.

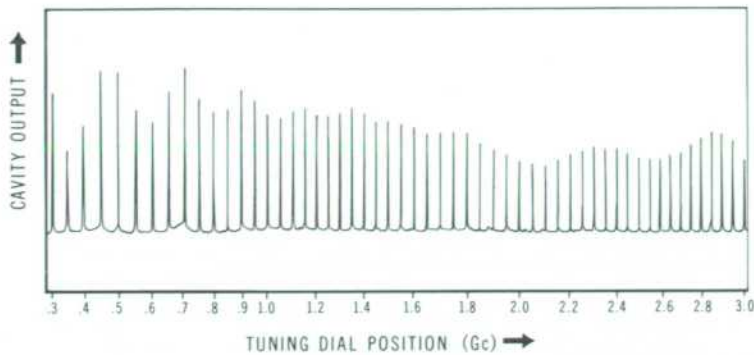

Fig. 5. Amplitude of harmonic frequencies singly provided at cavity output vs tuning dial position. Cavity selects any one harmonic of 50 Mc from comb generated from counter time base by step-recovery diode. Harmonics sensed here by square-law detector.

An electric field-sensitive probe in the cavity couples the selected resonating harmonic into the mixer, where it is heterodyned with the input signal. If the difference between the selected harmonic and the input frequency is within the passband of the video amplifier (1 to 53 Mc), the difference frequency is amplified and supplied to the counter for measurement. A sharp cut-off low pass filter prevents the amplifier from responding to difference frequencies that are beyond the frequency range of the counter. The difference frequency is also supplied to a rear-panel connector on the counter for external use.

A front-panel meter monitors the amplifier output amplitude. The meter deflects into the "green" area whenever a difference signal of sufficient amplitude exists. This provides a positive indication that the converter is tuned to a suitable harmonic.

In using the plug-in, the operator tunes from a frequency lower than the input, through consecutively increasing harmonics until the meter deflects into the "green" area. The counter then displays a number that can be mentally added to the value indicated by the tuning dial (a multiple of 50 Mc) to determine the input frequency.

The new plug-in has a wide dynamic range enabling operation with input signals from 50 mv to 1 v rms (-13 to $+13$ dbm). Input impedance is nominally 50 ohms throughout the input frequency range and a type N connector is provided (a directional coupler and waveguide-to-coax adapter can be used to connect waveguide signals to the plug-in*).

*e.g., an —hp— Model S752A 3 db coupler and an —hp— Model S281A Waveguide-to-Coaxial Adapter.

DESIGN CONSIDERATIONS

The primary objective during the design of the new plug-in was to achieve operating simplicity and a wide dynamic range in addition to a broad frequency range. Freedom from spurious mixer responses, unwanted resonator modes, and noise sources that might cause erroneous measurements were also carefully considered.

Hewlett-Packard has had considerable experience with similar instruments, but the realization of the new plug-in required more than a simple extrapolation of previous designs. The resonating cavity, for instance, operates throughout a 10-to-1 frequency range (0.3 to 3 Gc) at frequencies where a 2-to-1 coverage is typical. To achieve the wide tuning range, the dominant resonant mode of the cavity makes a transition from a capacitively-loaded TEM co-axial mode to a TM_{010} hollow cylindrical mode as the tuning plunger is withdrawn from the cylindrical cavity. Throughout this tuning range, the resonances of unwanted cavity

Fig. 6. Hewlett-Packard 0.3–3 Gc Frequency Converter and 50 Mc Counter (upper unit) as used in Boonton Radio's 8925A Test Set which calibrates and tests DME (distance measuring equipment) and ATC (air-traffic control) airborne transponders. Counter and converter monitor signal generator output, which is modulated by external pulses to simulate DME and ATC pulses for transponder receiver, throughout 950–1250 Mc range.





Fig. 7. Hewlett-Packard Model 5254A Frequency Converter enables -hp- 50 Mc counter to make frequency measurements within 300 to 3000 Mc range. Tuning dial, calibrated at multiples of 50 Mc, selects harmonic of 50 Mc signal to be subtracted from input signal. Meter shows when converter is tuned to harmonic that is within 53 Mc of input.

modes have been kept above 3 Gc by an appropriate choice of dimensions.

The internal surfaces of the cavity are also shaped to achieve a nearly linear relationship between resonant frequency and tuning plunger position. This linearity permits the use of a simple drive mechanism that provides a smooth, positive, and consistent tuning action over the entire frequency range. Another consequence of this

linearity is the ease of reading the tuning dial, with its nearly uniform spacing of 50 Mc harmonic calibration marks.

Cavity output coupling is by way of a probe which is shaped and located to make the cavity loaded Q proportional to resonant frequency. The variable Q results in nearly constant selectivity (or bandwidth) throughout the tuning range. This constant selectivity is illustrated by the even width of the responses shown in Fig. 5.

Besides being constant, the selectivity is also optimized by the cavity design. If selectivity were too high, tuning would be unnecessarily difficult; if too low, the selected harmonic would be accompanied by adjacent harmonics which would modulate the selected harmonic at a 50 Mc rate. The presence of this modulation would result in unwanted frequency components within the passband of the amplifier.

The successful development of the plug-in also depended on advances in the state-of-the-art of semiconductor devices. The close cooperation of -hp- Associates in the development of a step-recovery diode for the harmonic generator

allowed instrument development to proceed concurrently with diode development. The new diodes generate a remarkably uniform harmonic spectrum to beyond 3000 Mc, as shown by the plot of cavity output in Fig. 5. A spectrum such as this requires a diode switching time of about 120 picoseconds. Tight quality control of diode characteristics for spectrum uniformity also contributes to the achievement of uniform input sensitivity and helps avoid spurious mixer responses.

PERFORMANCE CHARACTERISTICS

Fig. 2 illustrates the performance characteristics of the new plug-in. The graph was made by plotting the plug-in video output voltage while the tuning control was cranked through its entire range. Responses are found only at the two harmonics that generate difference frequencies of less than 53 Mc with the input signal. One of these harmonics lies below the input frequency, the other above it.

The two responses are well defined and they show the good selectivity of the cavity. The small



Fig. 8. Companion Frequency converter, -hp- Model 5253B, measures from 50 to 500 Mc, completes frequency coverage. Counter and two frequency converters thus span frequency measurement range of dc to 3000 Mc. This plug-in is similar in basic concept to the 0.3-3 Gc converter.

DESIGN LEADER



Charles M. Hill

Charlie Hill joined -hp-'s Dymec Division in 1957 where he designed a number of special systems and components, including doppler data systems, programming circuits for signal generator systems, and the Dymec 2542 high speed tape punch coupler. He transferred to -hp-'s Frequency and Time Division in 1960, worked on the -hp- 5275A 100-Mc Time Interval Counter, and later became group leader on the development of plug-ins for the -hp- 5245L 50-Mc Counter. He is a graduate of the University of California (BSEE) and, before joining -hp- spent several years in military communications, radar, and digital computer development.

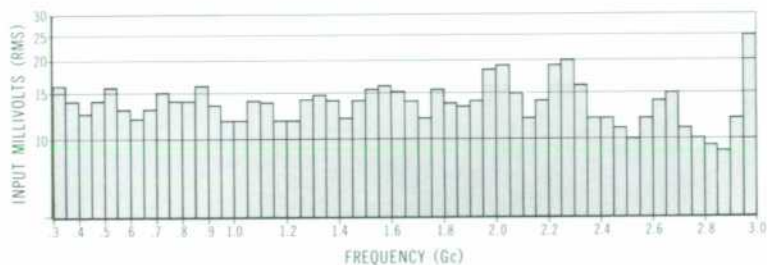

Fig. 9. Sensitivity of typical 5254A Frequency Converter. Each bar in graph corresponds to one tuning position of tuning control and vertical displacement indicates input signal level required to bring front panel meter to start of green region for each tuning position. (Rated sensitivity is 50 mv rms.)

amount of noise across the band is another indication of the cavity selectivity and of the spectral purity of the 50 Mc harmonics.

The plug-in response is also free of spurious cavity modes and of undesired frequency products from the mixer. The balanced mixer configuration suppresses the even harmonics of both the input signal and the cavity output. As long as the input signal is reasonably free of extraneous frequency components, the operator can have confidence in

any reading that he makes while the meter is in the green area. If the input signal is noisy, the operator can verify the measurement by retuning to the next higher harmonic. The counter reading is then subtracted from the dial indication to find the unknown.

CONCLUSION

Several disciplines and the technical abilities of a number of people at *-hp-* have been brought together in developing and produc-

SPECIFICATIONS
-hp-
MODEL 5254A
FREQUENCY CONVERTER PLUG-IN
(Installed in *-hp-* 5245L
Electronic Counter)

RANGE: As a converter for the *-hp-* 5245L Electronic Counter, 0.3 to 3.0 Gc.

ACCURACY: Retains accuracy of *-hp-* 5245L.

INPUT SIGNAL LEVEL: 50 mv rms (-13 dbm) to 1 v rms (+13 dbm).

INPUT OVERLOAD: Input power in excess of 100 mw (+20 dbm or 2.2 v rms) may damage converter.

INPUT IMPEDANCE: Approximately 50 Ω .

INPUT CONNECTOR: Type N female.

LEVEL INDICATOR: Meter aids frequency selection; indicates output voltage level to counter.

REGISTRATION: Counter display is added to converter dial reading.

WEIGHT: Net, 5 lbs. (2, 5 kg). Shipping, 9 lbs. (4 kg).

PRICE: \$825.00
Prices f.o.b. factory.
Data subject to change without notice.

ing the new plug-in. Their contributions in extending electronic counter measurements to a much higher range of frequencies than was previously feasible are appreciated and acknowledged.

— Charles M. Hill

CHANGES IN STANDARD BROADCASTS

CONTINUOUS VLF SERVICE

National Bureau of Standards VLF standard frequency radio stations WWVB (60 kc) and WWVL (20 kc) will extend broadcast hours starting on July 1, 1964. At that time the stations will resume continuous service in place of the restricted schedule described in an earlier announcement*. Alternate Tuesday bi-weekly silent periods, however, will be retained.

IDENTIFICATION OF WWVB

Positive identification of station WWVB for phase-lock receiver listeners will be provided by once-an-hour changes in phase, also starting on July 1. At the start of the 11th minute of each hour, the 60 kc carrier will abruptly advance by 45° and will return to normal on the start of the 16th minute. The phase shift will be initiated with 1 millisecond time accuracy and will be spaced with 1 μ sec precision.

*Modifications in NBS Standard Frequency and Time Broadcasts," Hewlett-Packard Journal, Vol. 15, No. 7, March, 1964.

WWVL CARRIER KEYING

Experiments in "on-off" keying will be conducted on WWVL during July and August with a program of 50 millisecond interruptions ten times a second in the 20 kc carrier. Interruption times will be accurate one-tenth second marks. Phase-lock receivers may be used for frequency comparisons during this time.

CHANGES IN WWVH SCHEDULES

Voice announcements of Hawaiian Standard Time (150° West Time) will be added to broadcasts from NBS Radio Station WWVH, Maui, Hawaii, on July 1, 1964. The announcements, related to Universal Time, will be made on all broadcast frequencies (5, 10, and 15 Mc) during the first half of every fifth minute of the hour. Also, voice station identification every five minutes will be added to the existing identification in International Morse Code.

Immediately following "on-the-hour" voice announcements, the frequency offset** will be given in International Morse

Code; propagation forecasts will be broadcast in International Morse Code every five minutes, in place of the former twice-an-hour schedule.

***New Time Information Added to WWV/WWVH Broadcasts," Hewlett-Packard Journal, Vol. 15, No. 8, April, 1964.

CHANGES IN NAVY VLF FREQUENCIES

The frequencies of the U. S. Navy VLF radio stations are to be changed, according to the U. S. Naval Observatory, Washington, D. C. The schedule of frequency changes is as follows:

1 June 64. NLK/NPG, Jim Creek, Washington, changes from 24.0 kc to 18.6 kc.

5 June 64. NAA, Cutler, Maine, resumes transmissions with a change to 17.8 kc and FSK (these transmissions will not be usable for frequency calibration).

8 June 64. NBA, Balboa, Canal Zone, changes from 18.0 kc to 24.0 kc.

NSS, Annapolis, Maryland, continues on 21.4 kc.

A NEW OSCILLOSCOPE PLUG-IN WITH FOUR 40-MC CHANNELS

An oscilloscope plug-in with four wide-band channels, any of which can be chosen to trigger the sweep, greatly simplifies investigating today's sophisticated pulse and digital circuitry.

DESIGNING and testing contemporary pulse and digital equipment often requires visual monitoring of several waveforms at the same time. Oddly enough, this is a situation for which even the use of several oscilloscopes is not a satisfactory solution because of the difficulty of watching waveforms on oscilloscopes spaced over a distance of several feet.

To provide a truly helpful solution to this problem, a new plug-in has been designed which enables four signals to be simultaneously viewed on *-hp-*'s standard high-frequency oscilloscope (Model 175A). The new plug-in has four identical and independent channels, each having a bandwidth of from dc to 40 Mc. The channels can be alternately switched at the end of each sweep or sequentially chopped at a 1 Mc rate to permit optimum displays of both high and low rep-rate signals.

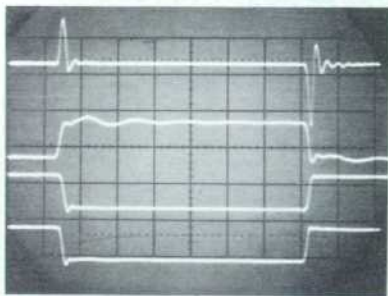

Fig. 2. Current and voltage waveforms can be displayed at same time with new Four-Channel Plug-in by using *-hp-* 1110A Current Probes in place of voltage probes. Waveforms here are of a vacuum-tube pulse power amplifier; from top to bottom: grid current, grid voltage, plate current, plate voltage.

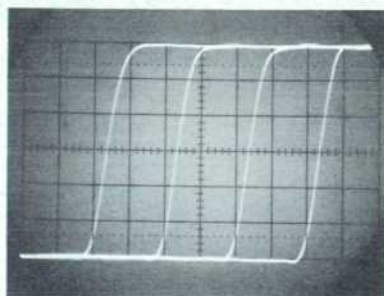

Fig. 3. Multiple exposure photo shows typical rise time of each channel in Four-Channel Plug-in. Rated rise is 9 nanoseconds. Sweep speed is 10 nsec/cm. Average rise time here (10% to 90% dots) is 8 nsec, corresponding to a 3-db h-f point of about 45 mc.

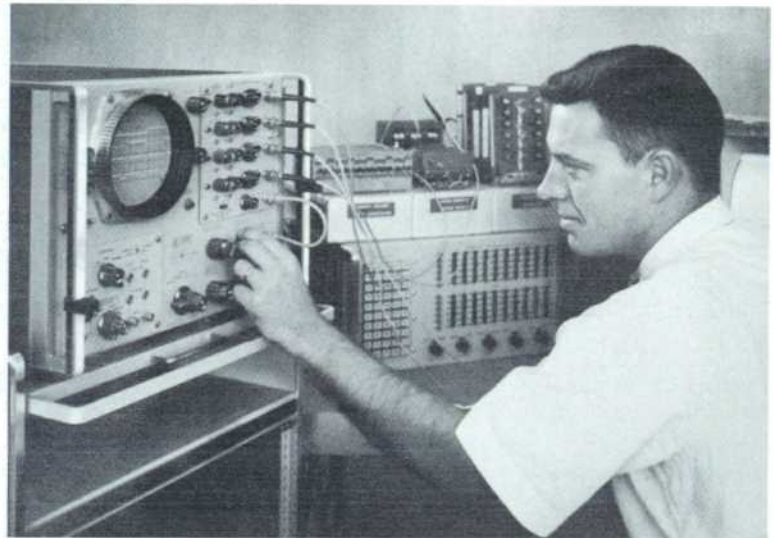

Fig. 1. New Plug-in for *-hp-* Model 175A Oscilloscope enables simultaneous viewing of up to four waveforms by means of four identical 40-Mc channels. Front panel switch selects waveform from any channel to serve as sweep trigger for all traces, giving extra convenience in examining time-related waveforms.

A special feature of the plug-in is that it has been designed with circuitry that permits the signal in any one of the four channels to trigger the oscilloscope sweep. This ar-

range-ment considerably broadens the convenience in establishing desired timing references without the necessity for interchanging test probes. The plug-in is also equipped with four push-switches which vertically displace the traces on the screen to permit quick identification of any one trace.

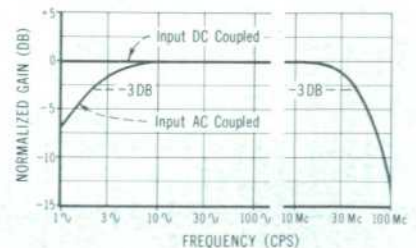

Fig. 4. Typical frequency response of Four-Channel Plug-in when installed in *-hp-* Model 175A Oscilloscope. Front panel switches select ac or dc coupling for each channel independently.

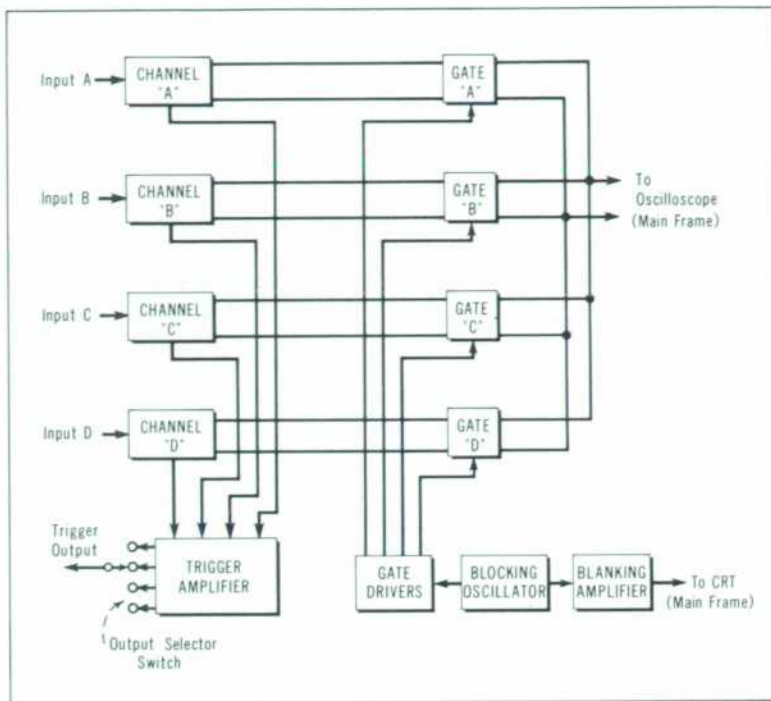

Fig. 5. Block diagram of -hp- Model 1754A Four-Channel Plug-in Amplifier.

The 40 Mc bandwidth of the channels leads to a rise time in each channel of less than 9 nanoseconds (Figs. 3 and 4). This fast rise, in combination with the four channels, makes the plug-in very versatile indeed. The basic sensitivity of the channels is 50 millivolts/cm. Additional conveniences include the fact that unused channels can be turned off, and the display of any and all channels can be inverted.



Fig. 6. Each channel of -hp- Model 1754A Four-Channel Plug-in Amplifier has independent controls. Mode Switch has "Off" position which removes any unneeded channel from CRT display.

CIRCUITRY

A block diagram of the new plug-in is shown in Fig. 5. Each channel is independent and has its own attenuation, positioning, polarity, gain, and balance controls. The outputs of the channels are connected to the main frame through gates, only one of which is permitted to be open at a time.

The gate driver is a tetrastable circuit driven by a blocking oscillator that can either free-run at 1 Mc ("Chopped" mode) or be triggered at the end of each sweep ("Alternate" mode). The blocking oscillator also initiates a pulse which

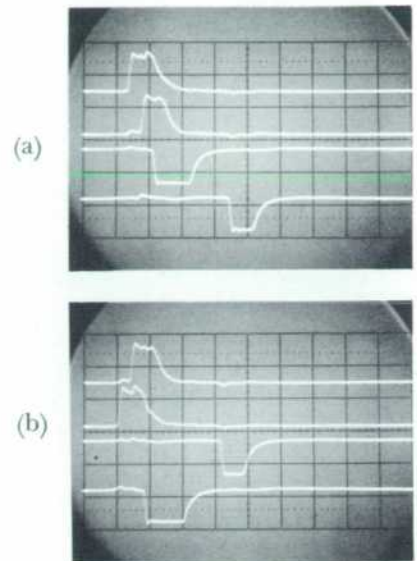

Fig. 8. Oscillograms showing operation of anti-coincidence gate as displayed by 175A Scope with 1754A Four-Channel Plug-in. (a) Input pulse in channel A (top trace) leads input pulse in channel B (second trace) by 0.8 μ sec. Channel B output (fourth trace) is delayed to follow channel A output (third trace) by more than 4 μ sec. (b) Channel A input lags Channel B by 0.8 μ sec. Channel A now is delayed 4 μ sec with respect to Channel B output.

blanks the CRT during channel switchover. Front panel on-off switches enable the gate driver to bypass any unused channel to shorten the timing sequence when all channels are not used.

The trigger amplifier acts as a buffer between the signal channels and the trigger selector switch. The switch connects the selected output to the horizontal sweep trigger in the oscilloscope main frame by way of a front panel connector. The trigger amplifier has a rise time of

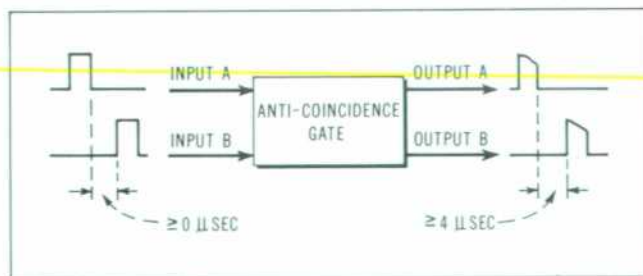

Fig. 7. Anti-coincidence gate delays either pulse train as needed to provide at least 4 μ sec time separation between output pulses. Evaluation of gate performance requires simultaneous viewing of both output and both input pulse trains, shown in Fig. 8.

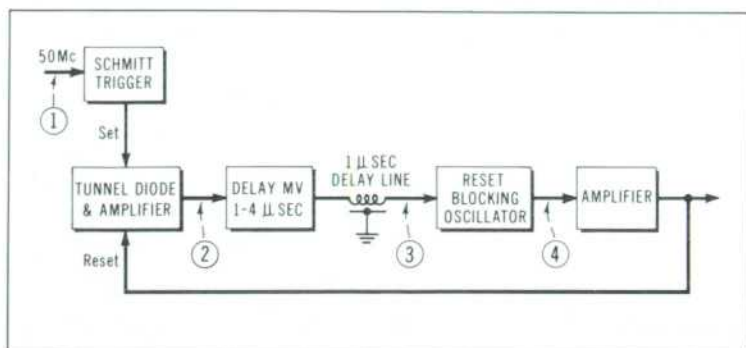

Fig. 9. Evaluation of countdown circuit (see text) requires that waveforms be monitored at four numbered places shown. See Fig. 10.

approximately 35 nanoseconds when the channels are switched alternately. This provides stable, low-jitter triggering of the oscilloscope sweep on pulses as narrow as 10 nanoseconds. The trigger amplifier is dc-coupled to permit triggering of the oscilloscope by dc signals.

APPLICATION DATA

If an increase can be obtained in the number of test points that can be simultaneously observed and related in a pulse or logic circuit, there will be a corresponding increase in the ability of a designer or test engineer to optimize a circuit or to solve the complex problems that arise. Such an increase is provided in the new plug-in and it has proved itself an effective tool in achieving confidence and understanding of switching, timing, and energy-storage principles in circuit operation. A specific case where a four-channel display has been of great value is in evaluating an anti-coincidence gate, represented in Fig. 7. The gate controls the passage of two pulse trains to a totalizer. One train adds to the totalizer count while the second subtracts. The gate prevents simultaneous passage of pulses by delaying either train as necessary. The four-channel simultaneous display made it possible to measure time delay from input to output, relative timing of the two inputs, and the desired anti-coincidence features of the outputs. Fig. 8 shows the waveforms involved.

In another interesting circuit problem it was necessary to optimize the design of a high-speed countdown circuit (Fig. 9). The circuit was required to divide a frequency of 50 Mc by factors up to 250. It does this by generating a reset pulse for a tunnel diode trigger circuit at some selectable time after the tunnel diode is "set" by a cycle of the 50 Mc signal. The countdown ratio is thus determined by the time interval between the "set" and "reset" action. The waveforms involved are shown in Fig. 10. Using the plug-in's four channels gave timing, delay, rise time, and high-frequency information. It was also possible to optimize and establish limits for countdown ratios by simultaneously measuring reset, tunnel diode voltage, gate output,

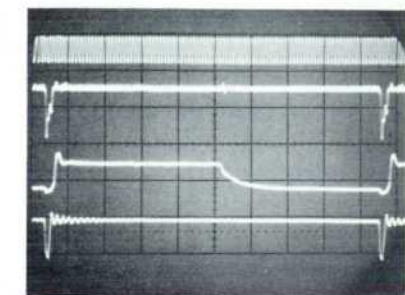

Fig. 10. Waveforms corresponding to numbered test points in countdown circuit of Fig. 9, as displayed with new Four-Channel Plug-in.

and the countdown monostable base-ramp waveforms.

The plug-in can, of course, also display current waveforms on any channel merely by replacement of the voltage probe by one of the *-hp-* current probes. Fig. 2 shows a typical example.

ACKNOWLEDGMENTS

The mechanical design and packaging of the four channel plug-in was performed by James D. Williams. Valuable design suggestions were provided by Floyd G. Siegel, project leader for the Model 175A Oscilloscope.

— James R. Pettit

DESIGN LEADER



James R. Pettit

Jim Pettit, project engineer on the four-channel oscilloscope plug-in, began work in the *-hp-* Oscilloscope laboratory two years ago. He is presently a member of the design group on the *-hp-* 140A Oscilloscope. He is a graduate of Utah State and is currently completing work at Stanford for his MSEE.

SPECIFICATIONS

-hp-

MODEL 1754A

FOUR-CHANNEL AMPLIFIER

(Installed in *-hp-* 175A Oscilloscope)

MODE OF OPERATION

Any channel or combination of channels may be displayed. Channels displayed on alternate sweeps or by switching at 1-Mc rate with blanking during switching.

EACH CHANNEL

SENSITIVITY RANGE: 0.05 v/cm to 20 v/cm. Nine calibrated ranges in 1, 2, 5, 10 sequence. Vernier extends minimum sensitivity to at least 50 v/cm.

ATTENUATOR ACCURACY: $\pm 3\%$.

PASS BAND: dc coupled; dc to 40 Mc; ac coupled: 2 cps to 40 Mc.

RISE TIME: Less than 9 nanoseconds.

INPUT IMPEDANCE: 1 megohm shunted by approximately 22 pf.

MAXIMUM INPUT: 600 v peak (ac + dc).

POLARITY OF PRESENTATION: +up, -up; selectable for each channel.

TRIGGERING OUTPUT: Output suitable to trigger 175A externally.

GENERAL

WEIGHT: Net, 7 lbs. Shipping, 9 lbs.

PRICE: \$595.00.

Prices f.o.b. factory
Data subject to change without notice.