



A New 120 KC Industrial Counter for Measuring RPM, Velocity, Quantity, Flow, Etc.

FREQUENCY counters are being used more and more for making the precision measurements important in industrial work. Such measurements include the rpm of all sorts of rotating devices, measurements of velocity, length, pressure, etc.

A compact new frequency counter has been developed especially for such industrial applications. This new instrument counts frequencies or electrical events up to a maximum rate of 120,000 per second. It is thus capable of counting the rpm of even the fastest rotating devices. It is provided with a display capacity of 9,999 counts and with sampling times of 1/10 or 1 second which are selectable by the operator. A panel switch further adds to the flexibility of the instrument by enabling the operator to start and stop a measurement manually in place of the

fixed sampling times. In addition, a panel jack is provided to permit the sampling time to be controlled by an external switch or relay.

The new counter makes two types of measurements. First it will count externally-applied electrical events for an interval of 1/10 or 1 second as desired. The quantity it displays is thus equal to events per tenth second or per second. Second, if the manual start-stop (gate) switch is used, the counter will totalize indefinitely as determined by the switch instead of for a fixed interval. Or, if the panel jack is used with suitable external contacts, the counter can be used, for example, to count the number of drum revolutions for a given rise in brake temperature under various load conditions, or for many other applications where rotation as a function of some dependent quantity is desired.

CIRCUIT

The basic arrangement of the counter is shown in Fig. 2. The frequency to be measured is applied to a gate circuit whose opening and closing is controlled either by an internal time base circuit or externally. When the gate is open, the signal passes through and drives a series of four decade counters which totalize the number of cycles applied to them. A display time circuit enables the operator to adjust the time that the count is displayed after the measurement is made from 1/10 to 15 seconds before the counter automatically makes the next measurement. Display time can also be held indefinitely if desired.

If it is desired to operate the opening and



Fig. 1. New -hp- Model 521A Industrial Electronic Counter measures frequencies up to 120,000 cycles per second. Internal time base system can be operated from power line frequency, from optional precision oscillator, or from existing standard frequencies.

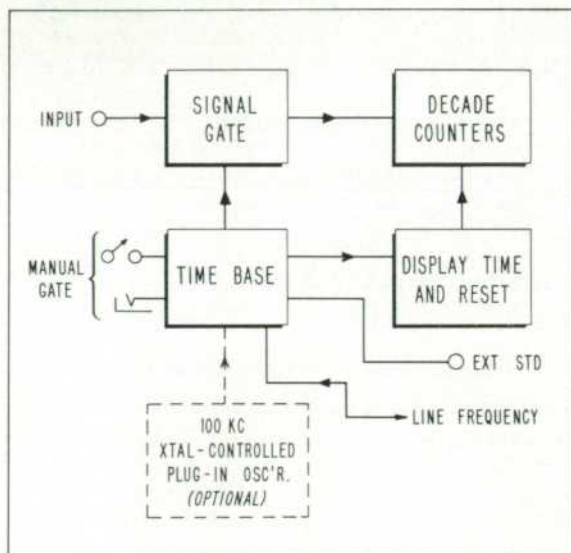

Fig. 2. Basic circuit arrangement of *hp*-Model 521A Electronic Counter.

closing of the gate manually or externally, a switch disconnects the time base and connects the gate to a panel switch and jack. The jack can be connected to a relay or other set of contacts. To open the gate from such an external connection, it is only necessary that the relay or contacts short the connections from the panel jack.

TIME BASE SOURCES

The time base circuit is arranged to derive its accuracy from one of three sources. First, the power line frequency (either 50- or 60-cps) can be used. Second, a crystal-controlled oscillator assembly is available as an accessory to plug in an otherwise vacant socket in the counter. Third, an external accurate frequency which is a multiple of 10 cps in the range from 10 to 100 cps can be used.

When the time base is derived from the power line frequency, the accuracy of the instrument will vary directly with the accuracy of the power frequency. The matter of power line accuracy has been investigated in most parts of the country as part of the development of the counter and in general found to be accurate within 0.1%. This accuracy is sufficient for many measurements. Some power systems have been

found at times to be inaccurate by as much as 3%, however, and in such locations one of the other two arrangements will most likely be preferred.

If an external frequency which is a multiple of 10 cps is to be used to operate the time base system, approximately 5 volts are required across the 0.5-megohm impedance of the terminal provided for connecting to the external frequency. The accuracy of the counter when

operated from an external frequency is equal to the accuracy of the external frequency ± 1 count.

The plug-in oscillator operates at 100 kc and is crystal-controlled. Using this oscillator will give the counter an accuracy of at least 0.01% ± 1 count. Actually, the crystal accuracy is rated by the crystal manufacturer as being within $\pm 0.01\%$ over a temperature range of from -20°C to $+70^{\circ}\text{C}$. The oscillator is set at the factory to an accuracy of within approximately 0.001% at an ambient temperature of approximately 23°C . It is thus apparent that considerably better than rated accuracy will usually be obtained.

MULTIPLE OPERATION

When a counter is equipped with the plug-in oscillator, a frequency of 100 cps is available at a rear terminal of the counter. This frequency has the same 0.01%-accuracy as the plug-in oscillator and can be used to supply the time base frequency for other counters which may be operated in the same general location. One plug-in oscillator can thus be used to supply the time base for up to 10 of the counters.

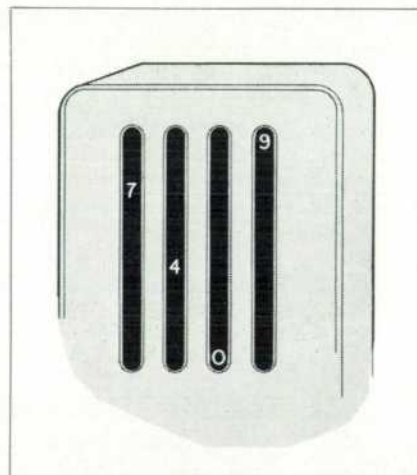

Fig. 3. Counter's display system presents measured frequency in illuminated numerals.

FOUR-PLACE DISPLAY

At first glance a display capacity of four places (9,999 counts) might seem inadequate for a counter which can count at rates up to six places (120,000) per second. By making use of the 0.1 second and 1 second gates, however, readings can be made to the full speed of the counter. The four-place counter is thus a means of enabling six-place measurements to be made where desired while maintaining the economy of size and circuitry desirable for a measuring instrument of this type.

To see how the four-place system can be used to make six-place measurements, assume that a measurement is being made of a 99,992 cps

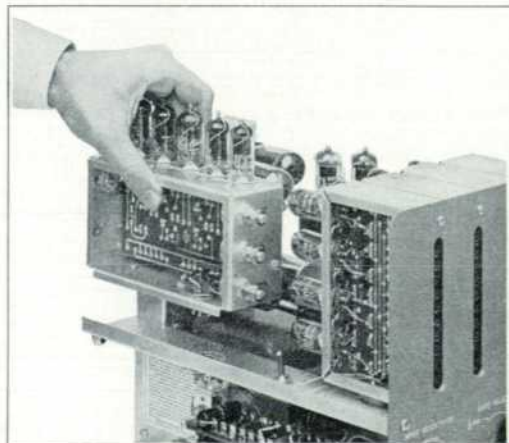

Fig. 4. Optional crystal-controlled oscillator plugs in otherwise vacant socket. Up to 10 counters can be operated from one such oscillator to obtain 0.01% accuracy for each.

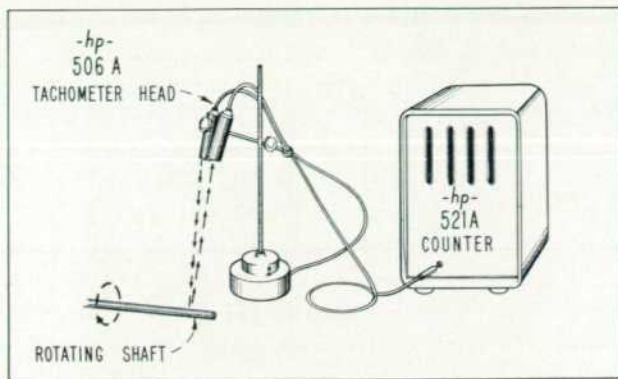

Fig. 5. Diagrammatic representation of -hp- 506A Optical Tachometer Pickup used with counter to measure shaft speed. Speeds up to 300,000 rpm can be measured with this set-up.

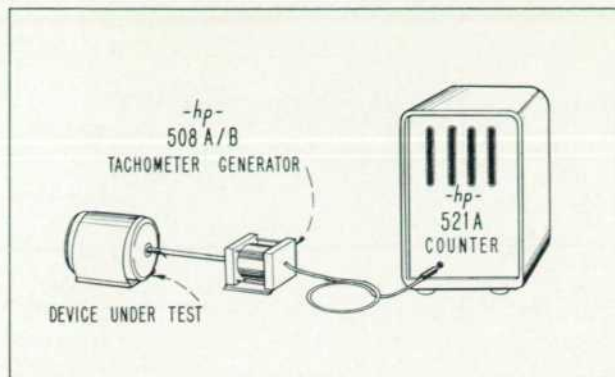

Fig. 7. Diagrammatic representation of -hp- Model 508 Tachometer Generator used with counter to measure shaft speed. Shaft speeds up to 40,000 rpm can be measured.

rate. If the measurement is first made using the 0.1-second gate time, the measured value will be 9,999 events per 0.1 second or 99,990 events per second. The fifth place in this example is obscure since it is obtained by ten-fold multiplication of a four-place measurement. If now a measurement is made using a 1-second gate time, the fifth place will be known since the counters will give a reading of 9,992. In this case, the ten-thousands reading will be off scale to the left on the display system, but that is of no consequence since the ten-thousands value is already known.

This system can be extended to the measurement of a six-place 120,000 cps rate by observing in the 0.1 second measurement whether the left-hand (thousands) counter goes "over the top." That is, if the left-hand counter unit illuminates all of its numbers from 0 through 9 in its

column and then re-illuminates one of its lower numbers, a ten-thousands unit should be added to the displayed count. A rate of 120,000 cps would thus be measured on a 0.1-second gate time as 2,000 cps per 0.1 second, but because the left-hand counter unit started to repeat, a quantity of 10,000 would be added to the measurement. A total of 12,000 cps per 0.1 second is thus obtained. Any ambiguity in the sixth place is removed by then making a 1-second measurement as before.

ACCESSORY PROVISIONS

Since the counter by itself counts electrical frequencies, it is necessary to convert to an electrical frequency the mechanical frequency, such as a shaft revolution, to be measured. This conversion can be effected by a suitable transducer. The counter simplifies this conversion by providing power for external use at two sets of terminals. One of these supplies is designed to operate the -hp- Model 506A Optical Tachometer Pickup which detects mechanical rotation through light reflection. The second supply is designed for general purpose usage and provides +300 volts d-c at 10 ma, -150 volts d-c at 5 ma, and 6.3 volts a-c at 0.6 ampere.

RPM MEASUREMENTS

Fig. 5 shows a diagrammatic representation of the counter operating with the 506A optical pickup.

The head consists of a light source and a photocell. When a rotating part has been previously prepared so that one-half of its surface is coated with a low-reflecting film, the photocell will detect the variations in intensity in light reflected to the photocell. The resulting voltage variations are passed to the counter for counting. This arrangement will permit very high rpm's to be measured and in addition will permit their measurement without mechanical loading. In the case of low-energy mechanical systems, this is an important advantage.

Other devices which can be used for rpm measurements are the -hp- Models 508A and 508B Tachometer Generators. These small generators are designed to be mechanically coupled to a rotating shaft. The 508A provides 60 cycles of output for each revolution of its shaft. The value presented on the counter when a one-second gate is used is thus directly readable in rpm. The 508B provides 100 cycles of output for each revolution of its shaft, giving a reading on the counter which is in hundreds of revolutions per second. Using a 1 second gate, readings can thus be made to a hundredth of a revolution per second.

OTHER MEASUREMENTS

Transducers are also commercially available which have frequency outputs proportional to pressure, flow,

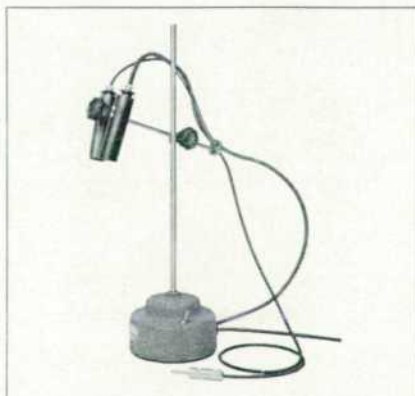

Fig. 6. -hp- Model 506A Optical Pickup.

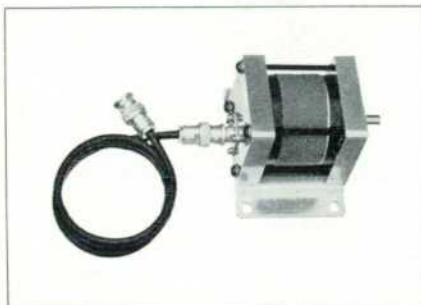

Fig. 8. -hp- Model 508 Tachometer Generator.

etc. In many cases these can be used with the counter to make readings of these quantities.

GENERAL

In the electrical and mechanical execution of the new counter's design, the full range of -hp-'s wide experience in the frequency counter field has been drawn on. The counter is furnished, for example, with the -hp- decade counter units* which are tested to a minimum 125 kc rate, which are constructed using reliable etched circuit techniques, and which have higher readability. These decade units also produce an output staircase voltage which can be used

with coincidence circuits to operate external recorders.

The counter is fan-cooled with air filtered by a renewable type filter. The chassis fits into the cabinet on a nylon bearing and channel arrangement which both acts as a guide and minimizes the mechanical effort needed to remove or replace the chassis. A collapsible bail on the cabinet permits tilting of the instrument for easy viewing of the front panel.

—Frank Kozluk

*Marvin Willrodt, "New Plug-In Decade Counters of Refined Design," Hewlett-Packard Journal, Vol. 6, No. 6, February, 1955.

-hp-

MODEL 521A INDUSTRIAL ELECTRONIC COUNTER

RANGE: 1 cps to 120 kc.

ACCURACY: ± 1 count \pm accuracy of timing frequency. (Approximately $\pm 0.1\%$ when power line used, $\pm 0.01\%$ with crystal standard installed.)

REGISTRATION: 4 places. Total count capacity 9,999.

INPUT REQUIREMENTS: 0.2 v rms minimum or output from 1P41 Phototube (or equal). Phototube bias provided at "PHOTOTUBE" jack.

INPUT ATTENUATOR: Adjusts sensitivity from 0.2 v to 100 v rms to overcome noise.

INPUT IMPEDANCE: Approximately 1 M Ω , 50 $\mu\mu$ f shunt (500 K Ω on "PHOTOTUBE" jack).

SPECIFICATIONS

GATE TIME: 1/10 and 1 second. Panel neon lamp indicates that gate is open.

MANUAL GATE: Controlled by "Open-Closed" switch or external contacts.

DISPLAY TIME: Variable from 1/10 to 15 seconds; or display can be held indefinitely.

READS IN: Cps or directly in rps or rpm with -hp- 506A or 508A/B Tachometer Accessories.

SELF-CHECK: Counts 60 cps line frequency (or 10 kc with optional plug-in oscillator) for any selected gate time.

EXTERNAL STANDARD: Can be operated from any multiple of 10 cps, 10 cps to 100 cps.

PHOTOTUBE INPUT: Supply voltage for 1P41 (or equal) phototube provided at phone jack on rear.

ACCESSORY SOCKET: At rear; supplies 6.3 v ac, 0.6 a; +300 v dc, 10 ma; -150 v dc, 5 ma.

CONNECTORS: BNC and std. phone jacks. POWER SUPPLY: 115 v $\pm 10\%$, 50/60 cps, 170 watts.

SIZE: Cabinet Mount: 9 $\frac{3}{4}$ " wide, 13 $\frac{3}{8}$ " high, 13 $\frac{3}{8}$ " deep.

WEIGHT: Cabinet Mount: 28 lbs. net; shipping weight 57 lbs.

ACCESSORIES PROVIDED: 1 each -hp- AC-16D Cable Assembly, 44" RG-58/U cable terminated one end with UG-88/U Type BNC connector.

ACCESSORIES AVAILABLE: -hp- Model 506A Optical Tachometer Pickup, \$100.00. -hp- Model 508A/B Tachometer Generator, \$100.00. -hp- 521A-59B Crystal Controlled Time Base (plug-in unit), \$100.00.

PRICE: -hp- Model 521A Industrial Electronic Counter, Cabinet Mount, \$475.00. -hp- Model 521A Industrial Electronic Counter, Cabinet Mount, with -hp- 521A-59B Crystal Controlled Time Base, \$575.00. For rack mount model, add \$5.00 to these prices.

All prices f.o.b. Palo Alto, California Data subject to change without notice.

SUMMARY OF -hp- ELECTRONIC COUNTERS

The -hp- family of counters provides for making measurements in an extremely wide range of applications. -hp- counting equipment is available for measuring frequencies as low as 10^{-7} cps or as high as 12,000 megacycles. Time intervals

as short as 1 microsecond or as long as 10^7 seconds can be measured.

The following table presents the leading characteristics of the various -hp- counters.

-hp- MODEL NUMBER	FREQUENCY RANGE	FREQUENCY ACCURACY	TIME MEASURING RANGE	"JOURNAL" ISSUE
521A	1 ~ 120 KC	0.01% or power line		This issue
522B	10^{-5} ~ 100 KC	5 PPM ± 1 count above 10 cps	10 μ sec - 10^5 secs	Sept.-Oct. 1953
524B	0 ~ 10 MC	1 PPM ± 1 count above 10 cps		Mar.-April, 1954
524B + 525A	0 ~ 100 MC	1 PPM ± 1 count above 10 cps		Mar.-April, 1954
524B + 525B	0 ~ 10 MC, and 100 MC - 220 MC	1 PPM ± 1 count above 10 cps		Mar.-April, 1954
524B + 526B	0 ~ 10 MC		1 μ sec - 10^7 secs	Mar.-April, 1954
524B + 525B + 540A	0 ~ 12,000 MC	Approx. 1 PPM ± 1 count above 10 cps		To be described in early issue
TRANSDUCERS				
506A	300-300,000 RPM			
508A/B	15-40,000 RPM			Nov.-Dec., 1953