

The Effect of Background Noise in Shared Channel Broadcasting

By C. B. AIKEN

The interference which occurs in shared channel broadcasting consists of several components of different types. Of these the program interference is usually the most important in the absence of a noise background, while if a strong noise background is present another component, which may be called flutter interference, predominates.

A simple theory of the flutter effect is developed and it is shown that its importance is dependent upon the type of detector employed. If manual gain control is used, flutter may be greatly reduced by the use of a linear rectifier. However, if automatic gain control is used this superiority of the linear detector cannot be realized and flutter is bound to be troublesome.

The results of experimental studies of the various types of interference are given and a comparison is made of the relative importance of flutter and program interference. The effects of the type of detector used and of the width of the received frequency band are observed. It is evident from these studies that improvements in the size of the lower grade service areas of shared channel stations might be obtained by close synchronization of the carrier frequencies, even though different programs are transmitted.

THE regulation requiring that carrier frequencies be maintained to within fifty cycles of their assigned values has resulted in the practical disappearance from shared broadcast channels of the heterodyne whistle, that most pernicious of all types of radio interference. Consequently, it is now unnecessary to have so large a ratio of the field strength of the desired signal to that of the undesired as was the case before the banishment of the high pitched squeal. Nevertheless, the field strength ratio which is necessary to permit of satisfactory reception on shared channels is still much higher than we should like it to be, and interference still abounds.

A very common type of interference is that which manifests itself as a fluttering or heaving sound, often very unpleasant in character. This phenomenon is caused by the periodic rise and fall of the background noise (static, R. F. tube and circuit noise, etc.) as the weak interfering carrier wave swings alternately in and out of phase with the carrier from the stronger station. In the complete absence of a noise background, program interference, or "displaced sideband interference"¹ as it may be called, is more troublesome than are flutter effects. Consequently, it is in regions other than the high grade service areas of shared channel stations that flutter effects are most annoying. In such regions they occur most prominently when the

¹"The Detection of Two Modulated Waves Which Differ Slightly in Carrier Frequency," *Proc. I. R. E.*, January, 1931, and *Bell. Sys. Tech. Jour.*, January, 1931.

frequency difference of the desired and interfering carriers is only a few cycles per second. As this difference is increased the flutter is transformed into a more sustained sound, rather harsh in character, and as it is still further increased a low growl appears which becomes more objectionable as it rises in frequency. The pitch of this growl cannot exceed 100 cycles unless one or both stations are violating the 50 cycle regulation. With the increasing use of very precise frequency control, heterodyne frequencies of a few cycles have become very common, and so, therefore, have flutter effects.

It has been pointed out in an earlier paper² that the magnitude of the flutter effect will depend upon the type of rectifier employed in the receiving set, and that it will be very much more objectionable when a square law detector is used than when a linear detector is employed. This is to be expected, since in the former case the audio-frequency output of the receiver will be proportional to the amplitude of the incoming carrier, while in the latter case the output will be essentially independent of the carrier amplitude, provided over-modulation does not occur. However, these statements refer to the case in which automatic gain control is not used. When the receiver is equipped with automatic control, as in most better grade modern receivers, the superiority of the linear detector is nullified and a serious flutter may occur.

In addition to displaced sideband interference and flutter, trouble may arise from distortion of the desired program by the action of the interfering carrier. One or both of the first two types of interference are likely to occur at lower field strength ratios than is the last, but at higher levels of the undesired carrier all three types are of importance and combine to degrade the quality of reception. In this paper, studies of all these types will be reported. Audible beat interference will not be discussed since it has been considered in other papers and, as just mentioned, is much less important than it used to be.

THEORETICAL ESTIMATION OF FLUTTER EFFECTS

As has already been stated, the flutter effect is due to the rise and fall of the level of the noise background with variation in the effective amplitude of the impressed carrier. In order to study this effect, let us suppose that there are impressed upon the detector a component of radio frequency noise which may be represented by $N \cos(\omega + n)t$, and a desired carrier $E \cos \omega t$. $n/2\pi$ is assumed to be an audio-frequency.

If a square law, or quadratic, detector is employed, the audio-

²"Theory of the Detection of Two Modulated Waves by a Linear Rectifier." *Proc. I. R. E.*, Vol. 21, pp. 601-629, April, 1933.

frequency output will be proportional to the audio-frequency component of

$$[E \cos \omega t + N \cos (\omega + n)t]^2,$$

which is

$$EN \cos nt. \quad (1)$$

Now suppose that there is impressed, in addition to the desired carrier and noise component, a weak carrier $e \cos (\omega + u)t$. The sum of the strong and weak carriers may be conveniently regarded as a single wave of amplitude

$$(E + e \cos ut).$$

This may be substituted for the amplitude E in (1), giving for the noise output

$$EN(1 + K \cos ut) \cos nt \quad (2)$$

in which

$$K = e/E. \quad (3)$$

The noise which is heard will consist of a steady portion, the amplitude of which is proportional to EN , and another portion of variable amplitude which is proportional to $ENK \cos ut$.

The factors that determine the importance of the flutter are many and complex, but it seems likely that the most important of them is the ratio of the variable component of the noise output to the steady component. As long as the noise is loud enough to be obvious, this ratio should be a fairly good measure of the perceptibility of the flutter, and we shall venture to regard it as such. The experimental data to be reported later will bear out this assumption.

From (2) it is evident that the ratio mentioned is merely K , the ratio of the amplitude of the interfering carrier to that of the desired carrier. We shall call this ratio the "flutter factor" for the quadratic detector and designate it by F_Q .

$$F_Q = K = e/E. \quad (4)$$

It is interesting that F_Q is independent of the amplitude N of the high frequency noise.

It is possible to derive a similar factor, giving the ratio of the variable to the steady components of noise, for the linear detector. From equations (70a) and (71) of the paper² already mentioned it follows that the flutter factor for the linear detector, at low modulations of the desired wave, is

$$F_L = \frac{Ne}{4E^2} = \frac{kK}{4}, \quad (5)$$

in which $k = N/E$.

F_L is seen to be dependent upon the strength of the high frequency noise as well as upon that of the interfering carrier. It is also to be noted that the flutter will be more serious with the quadratic than with the linear detector by a factor $4/k = 4E/N$, which is usually large.

This derivation of F_Q and F_L on the basis of a single frequency noise component serves to indicate important differences between the two types of detector and to show how the flutter changes with the noise level and with the ratio of the incoming carrier amplitudes. In any practical case the noise field would consist of numerous frequency components, but it is reasonable to expect that the proportionalities expressed in (4) and (5) would still hold. However, the absolute values of N and K at which the flutter becomes detectable must be determined experimentally and may be expected to depend upon the width of the received frequency band.

In the foregoing derivations it has been assumed that there is no automatic volume control in the receiving set. A brief examination of the effect of such a device will now be made.

ACTION OF AN AUTOMATIC VOLUME CONTROL

The comparative freedom from flutter effects which has been noted in the case of the linear detector may be regarded as due to the fact that the audio-frequency output of such a detector is independent of carrier amplitude over a wide range. If automatic volume control is used in the receiving set, the amplitude of the carrier wave will be maintained practically constant at the input terminals of the detector. If the effective carrier amplitude impressed upon the antenna undergoes a periodic fluctuation, due to very low frequency heterodyning between the two stations, the gain of the radiofrequency amplifier will undergo cyclic variations, so as to keep the carrier constant at the detector. Obviously this will cause a fluctuation in the amplitude of the sidebands, be they due to noise or program.

From this it is evident that, on the one hand, flutter effects in the presence of a noise background will usually be of minor importance if a good linear rectifier is employed in conjunction with a manual volume control; while, on the other hand, these effects may become extremely objectionable if automatic volume control is used. Because of the prevalent use of AVC in modern radio receivers the low flutter characteristics of the linear detector cannot be generally employed to reduce flutter interference on shared channels.

In the case of the square law detector, the output is proportional to the product of the amplitudes of the carrier and side frequencies. At first glance it might seem that the use of automatic volume control

should reduce the flutter effects, since it would iron out the variations in carrier amplitude impressed upon the detector. However, it is evident that this stabilization of the carrier will be exactly offset by the variation imposed upon the sideband amplitudes, and that consequently the flutter effects should be as evident when a normally functioning automatic volume control is used as they are in the case of manual control.

A perfectly functioning automatic volume control should make flutter effects approximately independent of the type of detector employed when the beat frequency is of the order of 2 or 3 cycles. However, at some of the higher frequencies, of the order of 20 to 40 cycles, the control will function with reduced efficiency, and at still higher frequencies will not function at all. Consequently, in this intermediate range the gain control may have some special effect and may make the flutter either worse or better than it would be with the same type of detector and manual control.

EXPERIMENTAL STUDIES

Equipment Used in the Study of the Effects of a Noise Background

A laboratory investigation was made of the interference between two waves of slightly different carrier frequency. A block schematic of the equipment used is shown in Fig. 1.

A modulated signal could be received from Station WABC, or, by throwing the switch *S*, it was possible to obtain an unmodulated carrier from a Western Electric No. 700A Oscillator, which is of very great frequency stability.³ Whichever signal was used was fed through an impedance matching transformer to a radio frequency attenuator. The output of this attenuator was fed into the grid of one tube of a mixing amplifier. As indicated in the drawing, this amplifier consists merely of two shield grid tubes having a broadly tuned common plate circuit load.

The other tube of the mixing amplifier was energized, through a second radio frequency attenuator, by an unmodulated carrier derived from a crystal controlled laboratory oscillator of the same type as that which served as an alternative to WABC. This oscillator was part of a Western Electric No. 1A Frequency Monitoring Unit.⁴ The monitor includes arrangements for measuring frequency differences between the oscillator included within it and an external source. In this case the external source was WABC, or the alternative carrier. The energy

³ O. M. Hovgaard, "A New Oscillator for Broadcast Frequencies," *Bell Laboratories Record*, 10, 106-110, December, 1931.

⁴ R. E. Coram, "A Frequency Monitoring Unit for Broadcast Stations," *Bell Laboratories Record*, 11, 113-116, December, 1932.

required by the frequency measuring device was supplied through a tuned buffer amplifier.

The voltage developed across the tuned circuit of the mixing amplifier was measured by a conventional form of vacuum tube voltmeter. By setting one attenuator at a very high loss, the magnitude of the signal supplied through the other could be measured, and the process then reversed. If the two signals were adjusted so as to give equal amplitudes across the tuned load, then any desired carrier ratio could be obtained by adding a known loss in one attenuator.

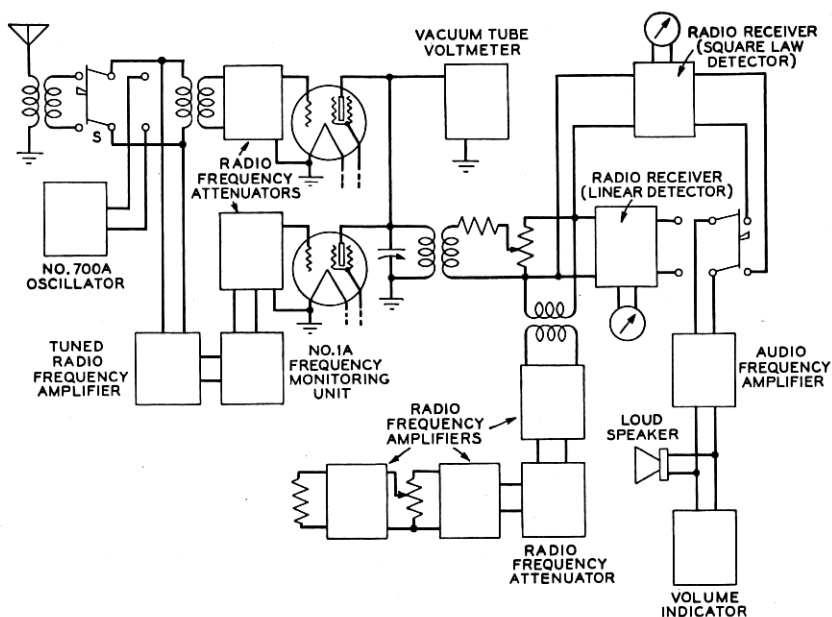

Fig. 1—Schematic circuits of experimental setup.

The mixing amplifier fed a shielded transmission line which included an adjustable pad. The line supplied energy to either of two radio receivers, one of which contained a square law and the other a linear detector. The output of the receiver was monitored on a loud speaker and also on a volume indicator. Meters were provided for indicating the change in direct current flow in the detector circuit of both receivers.

In order to study the effects of a noise background, a noise source of constant and controllable level was required. Furthermore, it was desirable that the noise be of a type frequently encountered in practice. The thermal noise generated in a high gain amplifier seemed to be suitable. Consequently, there were connected in cascade two amplifiers having a gain of approximately 44 db each, over the entire broad-

cast band. The output of the second of the units was fed through a radio frequency attenuator to the grid of a single stage amplifier, the output circuit of which contained a step-down transformer bridged across the transmission line feeding the radio receivers. With zero loss in the attenuator the noise energy fed to the line was ample for the purposes of the present study.

An additional description of some of the pieces of equipment used in the foregoing set-up may be of interest.

Source of Constant Unmodulated Carrier Frequency

The oscillator contained in the No. 1A Frequency Monitoring Unit is of unusual frequency stability. The piezo-electric crystal is mounted in a specially designed thermal insulating chamber which reduces the temperature fluctuations to an extremely small fraction of a degree. Voltage regulating equipment is included in the unit, giving further assistance in stabilizing the frequency. Detailed descriptions of the oscillator³ and of the frequency monitor⁴ have been published.

A similar oscillator is used as a control unit at Station WABC. Hence, it was expected that a very constant beat frequency could be obtained between that station and the local oscillator. The frequency of the latter was adjustable over a narrow range by means of a vernier condenser in the crystal circuit. Figure 2 shows a number of plots of

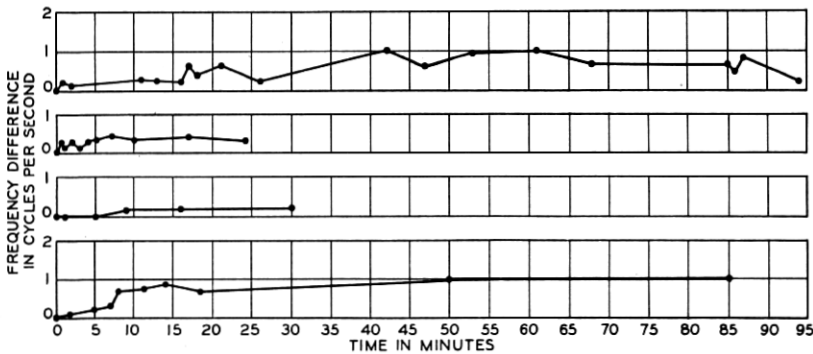

Fig. 2—Beat frequency between WABC and Western Electric No. 1A Frequency Monitoring Unit.

the beat frequency against time. These curves indicate an extremely slow drift, and experience has shown that the beat frequency would hold to within 0.4 cycle over a period of at least five minutes, and usually considerably longer. This high stability greatly facilitated work which required a very small difference in frequency of the two carriers.

Radio Receivers

Both receivers were high fidelity (7000 cycles) units of the tuned radio frequency type. One of these was modified so that either manual or automatic volume control could be used, and the level impressed upon the detector was reduced so that it would function as a strictly square law device. The cathode resistor which normally furnishes a grid bias for the detector tube was replaced by a battery. This was necessary in order to prevent straightening out of the characteristic by degeneration at very low frequencies. In Fig. 3 is shown a plot of

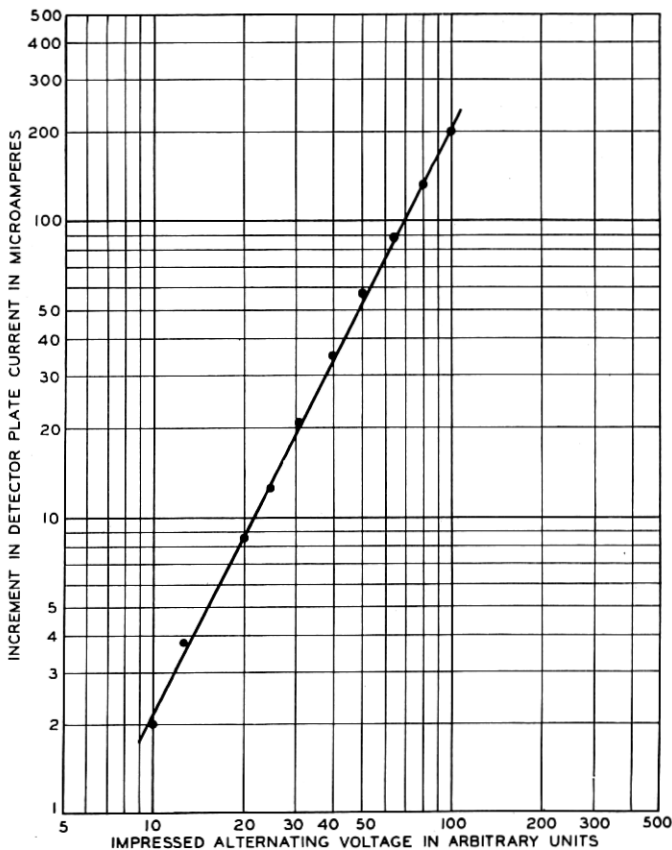

Fig. 3—Characteristic of radio frequency amplifier and square law detector.

the change in detector space current as a function of the impressed voltage. It will be observed that for increments of less than $200 \mu\text{A}$ the characteristic has a slope of two to one. All observations were

made at signal levels which were low enough to stay well within this range.

The other set was provided with a diode rectifier which functioned as a linear detector. In order to improve the linearity of the characteristic, an initial bias was used and was adjusted to obtain the best characteristic as indicated by the following test:

If a large unmodulated carrier is impressed on a linear rectifier, together with a much smaller unmodulated carrier, the beat frequency output should be independent of the amplitude of the larger carrier over a wide range. This phenomenon was observed experimentally and the initial bias was altered until the range, over which the large carrier could be adjusted without changing the output, was a maximum. In Fig. 4, the horizontal curve shows the magnitude of the

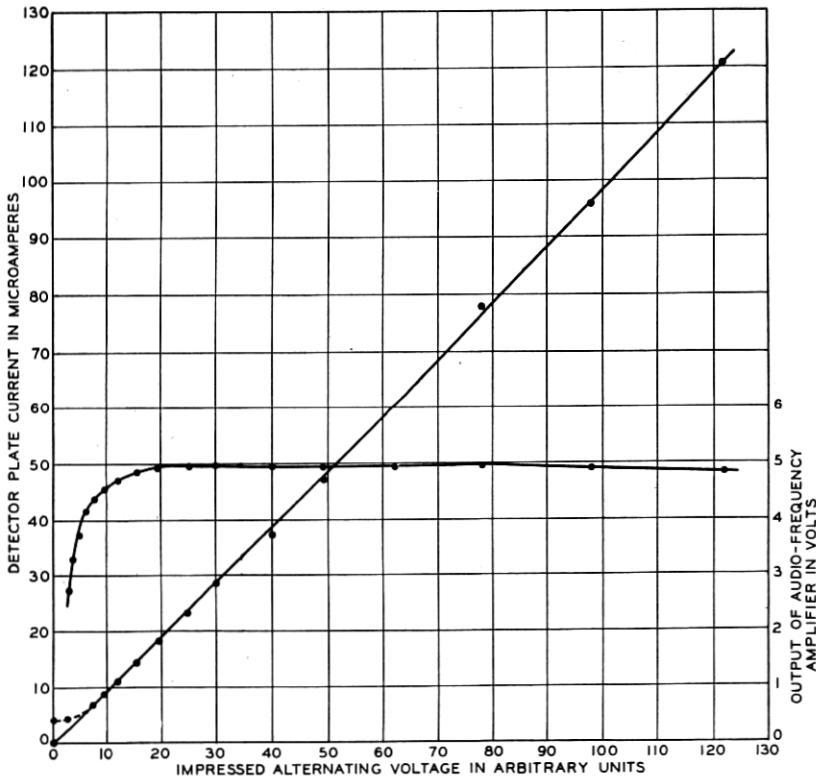

Fig. 4—Characteristics of radio frequency amplifier and linear detector.

audio-frequency output, while the sloping curve shows the direct current flowing in the detector circuit. The dashed curve is due to the

presence of the weak signal, while the solid one represents the effect of the large signal alone. The curves of this figure were taken with a bias of + 0.5 volt, which was found not to be critical.

The results of the experimental observations made with this detector were entirely in accord with theory, as will be discussed later, while similar observations made with a zero bias gave results which differed considerably from those predicted by the theory of the linear rectifier. Lack of the small bias caused a considerable departure from linearity, as was plainly evidenced by the fact that when it was absent the audio-frequency output due to the two carriers was by no means independent of the magnitude of the larger.

The tuned circuit in the mixing amplifier was so broad as to have an entirely negligible effect on the fidelity of the radio receivers.

Listening Conditions

In studying the effects of noise background some observations were made in the open laboratory, and a greater number in a partially deadened room 10 feet x 10 feet x 10 feet. The sound-proofing of this room was sufficient to keep out street noises and other extraneous disturbances of moderate intensity.

In determining the dependence of a given effect upon the magnitude of the carrier ratio, there was recorded that value of the ratio at which the effect was just perceptible.

Results of Experimental Work

A number of observations have been made with the intention of obtaining practical data on the characteristics of reception in the presence of a noise background, and with the purpose of checking the theoretical predictions already given. It has been pointed out that the flutter effects depend upon the type of detector which is employed and upon the ratio of the two carriers. If a square law detector is used the effect should be very nearly independent of the magnitude of the noise level, so long as it is within reasonable limits and does not either overload any of the equipment (including the ear of the listener) or fall so low as to be hardly noticeable. On the other hand, if a linear detector is employed, flutter effects should increase with the noise level. In either case the modulations of the two stations play no important part in determining the flutter effects except in so far as high modulations may temporarily mask them.

As a result of these considerations it was decided to employ unmodulated carriers for the greater part of the work. In order that a suitable level might be chosen, the strong carrier was first adjusted to

give the proper change in detector current. It was then modulated 30 per cent with a pure tone, and the gain of the audio-frequency output amplifier was adjusted until a fairly loud, but entirely comfortable, level was delivered to an observer placed about six feet in front of the loud speaker. The output level of the audio-frequency amplifier was read on a meter so that its gain might be checked later on.

The Linear Rectifier

The detector of a radio receiver was adjusted to have a linear rectifier characteristic in the manner just described and manual gain control was employed. In the first set of runs the carrier ratio was determined at which the flutter effect at low frequencies, or the carrier beat-note at higher frequencies, became just noticeable, the frequency being the variable. In Fig. 5 is shown a curve representing a number of

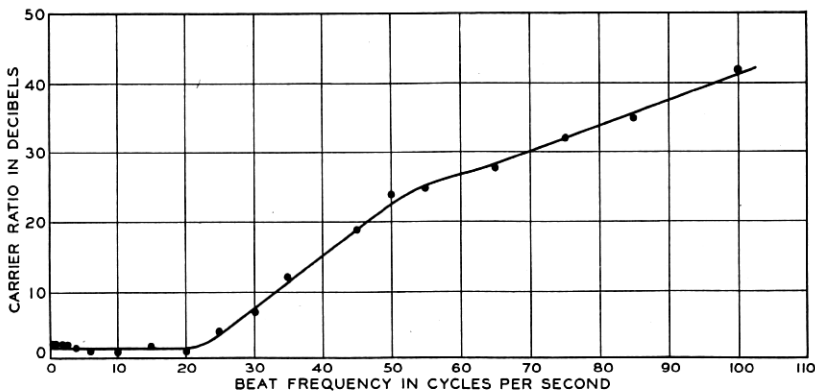

Fig. 5—Carrier ratio for perceptible flutter with a linear detector. Noise equivalent to 9.5 per cent modulation.

observations of this type. The noise level was constant at 10 db down from a 30 per cent modulated signal. By this it is meant that when the noise was impressed upon the receiver, together with a carrier the level of which had been fixed as described above, the audio-frequency output, as measured on a copper oxide level indicator, was 10 db below the audio output resulting from a 30 per cent modulation of the same carrier in the absence of noise.

A very interesting fact to be noted from this curve is that, for beat frequencies of less than about 20 cycles, the carriers must be very nearly equal before any flutter effect whatever may be detected. The average curve has been drawn through a value of 1.5 db. The observed values vary from this figure by not more than ± 0.5 db.

The right-hand portion of the curve is determined by the audibility of the beat-note, and its position will of course depend upon the masking effect of the noise background. Theory has indicated that the flutter frequency portion of the curve should drop with the noise level, but it is evident that, with such a small difference in carrier amplitudes as is indicated in the figure, the results would not be appreciably different were the noise level to be reduced. On the other hand a noise level which is down only 10 db from a 30 per cent modulated signal is equivalent to a modulation of nearly 10 per cent. This is an extremely objectionable noise level, so objectionable, in fact, that under the conditions of the tests it was very unpleasant to listen to. Consequently, it did not seem worth while to run curves similar to that of Fig. 5 for a number of different noise levels. Instead, a set of observations was made with a fixed carrier frequency difference of 2 cycles and a variable noise level. The results are indicated by the lower curve in Fig. 6.

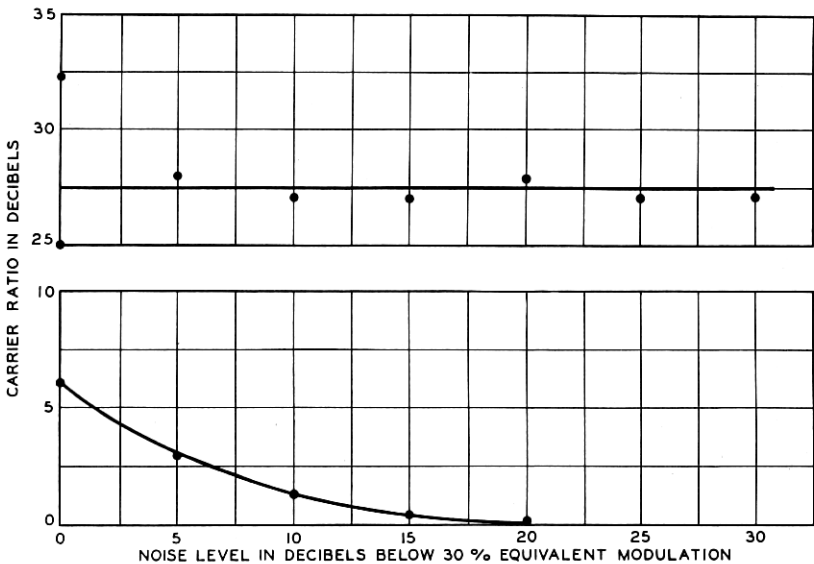

Fig. 6—Carrier ratio for perceptible flutter as a function of noise level. The upper curve is for the *square law* and the lower curve for the *linear detector*.

With a noise level equivalent to a 30 per cent modulation, a carrier ratio of only 2 : 1 is necessary to reduce the flutter to a barely detectable amount. At low noise levels, down 20 db or more from 30 per cent, the flutter could hardly be detected but there was noticeable a "bumping" sound which was due to the rather violent motion of the cone of the loud speaker at a frequency of 2 cycles. This was partially eliminated

by inserting a capacity in series with the voice frequency circuit of the speaker, but even when greatly reduced the bumping was detectable and was more important than any flutter which may have been present.

The Square Law Rectifier

Observations similar to those just discussed were made with a square law detector. In Fig. 7, the ordinates represent the carrier ratio neces-

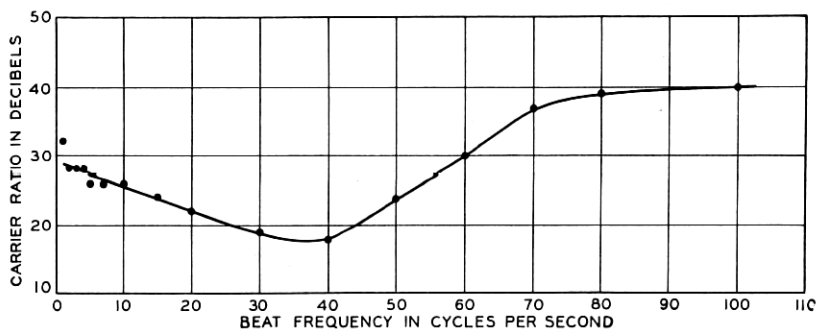

Fig. 7—Carrier ratio for perceptible flutter with a square law detector. Noise equivalent to 9.5 per cent modulation.

sary to reduce the flutter to a just detectable value, while the abscissae represent the beat frequency. The noise is 10 db down from an equivalent 30 per cent modulation. The curve is in striking contrast to that of Fig. 5. At very low frequencies a carrier ratio of 28 db is required when a square law detector is employed, while if the receiving set embodies a linear detector a ratio of 1.5 db is sufficient. The right-hand portions of the curves are fairly similar, since the carrier ratio is here dependent upon the audibility of the beat note and not upon flutter effects. The observations of which Fig. 7 is a record were made in the small sound-proof room. In Fig. 8 are shown two curves made in the open laboratory. In the upper curve the noise output was approximately 20 db down from that due to a 30 per cent modulated signal, while in the lower curve it was approximately 30 db down.

The theory which has been outlined indicates that in the case of the square law detector the flutter effects should be practically independent of noise level, and the curves shown in the last three figures bear out this prediction quite positively. Even more definite confirmation is furnished by the upper curve of Fig. 6, which shows the result of observations taken with a fixed beat frequency of 3 cycles. The two curves of this figure show the great superiority of the linear rectifier over the square law in receiving non-isochronous transmissions in the presence of a noise background.

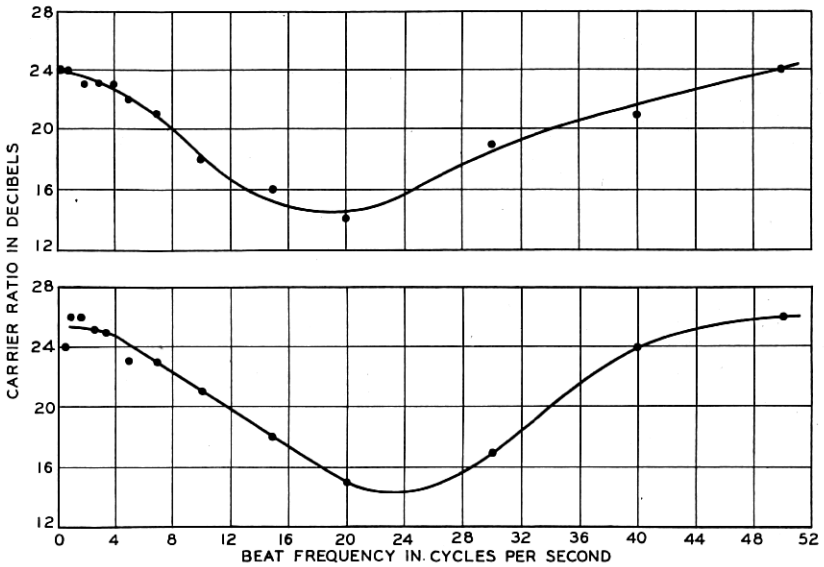

Fig. 8—Carrier ratio for perceptible flutter with a square law detector. Noise equivalent to 3 per cent modulation, for the upper curve, and to 0.95 per cent for the lower curve.

The Square Law Rectifier with Automatic Volume Control

It has been predicted that the use of automatic volume control in the receiving set should greatly increase the flutter effects observable with a linear rectifier, while with a square law device these effects should be the same for both automatic and manual control except, perhaps, at the frequencies of reduced efficiency of the gain control. An experimental check was made on the latter statement, the results of which are shown in Fig. 9. It will be noticed that this curve is very similar to the curves of Figs. 7 and 8.

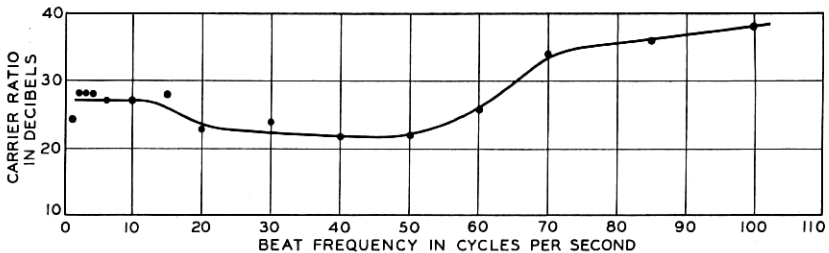

Fig. 9—Carrier ratio for perceptible flutter with automatic volume control. Noise equivalent to 9.5 per cent modulation.

The action of an automatic volume control, in keeping constant the level of the total carrier delivered to the detector, should become less pronounced as the beat frequency rises and should fail altogether when this frequency reaches the audible range. This reduction in efficiency of control may either increase, leave unaltered, or decrease the magnitude of the flutter, depending upon the amount of time delay involved in feeding back the controlling voltage. In the receiver used, the reduction in efficiency of the gain control occurred between 20 and 40 cycles. A comparison of Fig. 9 with Figs. 7 and 8 indicates that in this receiver the gain control tends to increase the flutter somewhat when the heterodyne frequency is within this range.

Interference of Undesired Program

When the interfering station transmits a program which is different from that of the desired station, serious interference may occur which is due primarily to the beats between the undesired sidebands and the desired carrier. If the carrier beat frequency is subaudible and there is little or no noise background, this will be the predominant form of interference. Its magnitude will depend upon the degree of modulation of the undesired signal, but is practically independent of the type of detector and gain control which are used. In the presence of considerable noise background it may or may not be more important than flutter effect.

In order to get some data on this point, observations were made with a square law detector and manual gain control. This represents about the worst condition, as far as flutter effect goes, but will be approximated by AVC receivers. At a fixed noise level the carrier ratio was determined at which the flutter could be noted, and also the ratio at which the program interference was detectable. This was done for receiver band widths of 7000 and 3500 cycles. The band width had no appreciable effect upon the program interference but exercised a very definite effect upon the flutter. Fig. 10 shows the results of the observations which were taken. The solid sloping curve represents the average of the observations on program interference, while the two horizontal curves show the carrier ratio at which the flutter was just detectable for the two bands widths used. The program interference was classed as audible when it could just be heard on the peaks of modulation. However, for considerable intervals of time it was entirely inaudible. Consequently, when the same carrier ratio was recorded for the flutter and for the program interference the former was actually the more annoying. In order to take account of this difference of character between the two types of interference it is necessary to

shift the program curve downward. Just how far it should be displaced is very hard to determine, as the amount will depend upon the type of program on the undesired station. Observations have indicated that the shift should amount to at least 7 db. The dashed curve in Fig. 10 has been drawn 7 db below the solid curve.

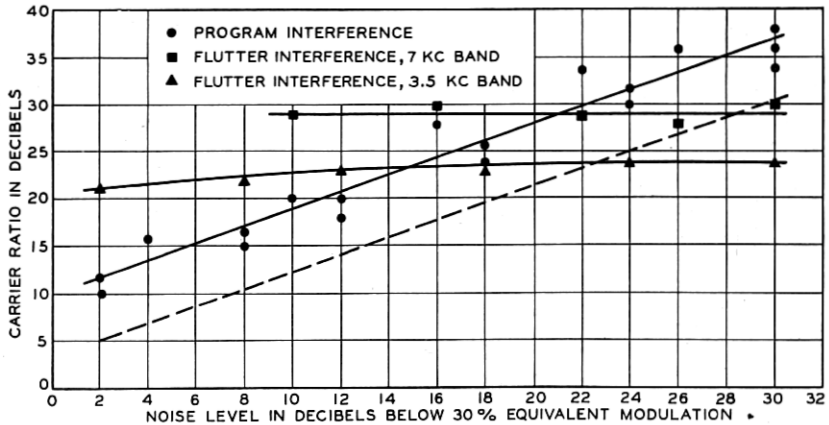

Fig. 10—Relative importance of program interference and flutter interference.

It will be noticed that with a band width of 3500 cycles the flutter curve crosses the program curve at a noise level equivalent to about 2 per cent modulation. (In every case the noise level was measured with the 7000 cycle band, regardless of what band was to be used in the listening tests. This should be kept in mind throughout the present discussion.) This means that at equivalent modulations of more than 2 per cent the flutter effect would be more objectionable than the program interference. However, at high noise levels, say 5 to 10 per cent, the listener would be sure to reduce the band width of his receiver to considerably less than 3500 cycles and this would reduce the relative importance of the flutter. Nevertheless, at very high noise levels the flutter is more important than the program interference. If the undesired station were to employ abnormally low modulation the program interference would be decreased and the relative importance of the flutter increased.

It is evident that the dependence of the flutter on band width, and the different reaction of individual observers as to what type of interference is the more objectionable, renders it impossible to make a definite statement as to the exact values of carrier ratio and noise field which will make the two types of interference equally important. But we can draw the useful conclusion that in cases of excessive noise, such

as may occur in rural areas without causing the listener to abandon attempts at reception, the flutter will be the more important. Consequently, an improvement in the service in such regions would be obtained by synchronizing the carriers of the two stations, even though they continue to transmit different programs.

Effect of Interfering Carrier on Desired Program

Even if the interfering wave were unmodulated and there were a negligible noise background, there still remains the possibility of distortion of the desired program by the heterodyning action of the undesired carrier. In order to determine how important this effect is as compared with those which have been discussed, a modulated carrier (derived from WABC) and a weaker unmodulated wave were used. A beat frequency of about 3 cycles was maintained during the course of these observations.

With the linear rectifier it was found that a perceptible distortion of the desired program could not be detected on speech and jazz music until the weak carrier was brought within 1 db of the strong one. When the program consisted of music containing many sustained notes, such as occur in a violin solo and even in vocal solos, the cyclic variations in output level were more noticeable. In such a case a ratio of about 4 db was necessary to reduce the distortion to the detectable limit.

With the square law rectifier it was found that a carrier ratio of 10 db produced detectable distortion with any type of program. At a ratio of 16 db distortion could be detected only when the program contained sustained notes, and at 18 db could be noticed only when the notes were sustained for a considerable time.

The dependence of the permissible ratio upon the type of program led us to make a similar observation when the strong carrier was modulated 30 per cent with a pure tone of 400 cycles. Under such conditions it was necessary to reduce the interfering carrier to about 34 db below the strong one before the 3-cycle variation in the pure tone definitely vanished.

CONCLUSIONS

The studies which have been reported furnish quantitative data on the various types of interference which are encountered in shared channel broadcasting and show what relative levels of interfering carrier may be tolerated under various conditions.

In high grade service areas the program from the undesired station will be the most serious form of interference, provided the carrier beat

frequency is subaudible. If there is a moderate noise background present, it will tend to mask the program and will therefore permit of somewhat higher interfering field strength. However, if the interference is raised beyond a certain level, dependent upon the received band width, flutter effects will become pronounced. This will not be true with a linear detector and manual gain control, but in practice radio receivers which have linear detectors almost invariably have automatic volume control.

If the noise level is very high it may mask even rather loud program interference, and under such conditions the flutter effect is likely to be much the most serious source of trouble. This condition is of practical occurrence in outlying areas where a degraded service must be tolerated continually. In such regions shared channel broadcasting is limited in usefulness primarily by the flutter effects, and in extreme cases, by distortion of the desired program due to the heterodyning action of the interfering carrier. Both of these types of disturbance would be eliminated by synchronizing the carriers of the two stations, and it seems likely that control of the carrier frequencies to within ± 0.1 cycle might definitely extend the limits of the lower grade service areas of shared channel stations.

ACKNOWLEDGMENT

I wish to acknowledge my indebtedness to Mr. J. E. Corbin for his assistance in carrying out the experimental work which has been reported in this paper.