

GA27-2776-5

File No. S370-09

**Systems**

**IBM 3600 Finance  
Communication System  
Operating Guide**

**IBM**



GA27-2775-5  
File No. S370-09

**Systems**

**IBM 3600 Finance  
Communication System  
Operating Guide**

**IBM**



## Preface

This manual is written for systems engineers, programmers, control operators who may be responsible for the operation of the 3600 system, and persons operating individual units or work stations in the system.

This manual is divided into eight major sections which are identified by tabs, Form GX27-2978. Several of these sections are further divided into subsections which are identified by keying pages. The keying pages have dark borders to allow you to quickly locate them.

Following the tabs and on most of the keying pages are contents listings telling you what material the complete section consists of. However, you or your institution may elect to remove the pages which contain material not required by your tasks. You may then wish to cross out those entries in the contents listings. For example, if your location does not have a 3618 Administrative Line Printer, the material for that unit may be discarded and the entry in the contents listings crossed out, thus leaving the balance of the manual intact.

You should also note that each section and subsection are uniquely page numbered so you may rearrange the order of the subsections within a major section to customize the manual to your needs.

All references to IBM part numbers throughout this manual should be understood to signify either that particular part number or its equivalent.

While IBM makes available many basic functions, the user chooses those he will utilize and in what manner. It is the responsibility of the user to establish and maintain appropriate operating procedures for the equipment. This, of course, includes those related to the integrity and security of the system, together with audit and control measures.

Some of the units, devices, options, and features described in this manual may not be available in every locale. Ask your local IBM marketing representative for detailed information about product availability.

**Important Notice:** The form number of the tabs for this edition is different from that of some of the previous editions. Be sure to use the tabs identified by Form No. GX27-2978-2.

*Sixth Edition (April 1977)*

This edition is a revision of, and replaces, GA27-2776-4 and its Technical Newsletter, GN31-0547; it applies to Independent Release 4 and subsequent releases until otherwise indicated in new editions or revisions. This edition corrects some minor production errors and revises the commands and messages. Since the changes affect primarily the commands and messages, the vertical lines that indicate revised text and art are not used.

Information in this manual is subject to change from time to time. Any such change will be reported in subsequent revisions or supplements.

A form is provided at the back of this publication for reader's comments. If the form has been removed, comments may be addressed to: IBM Corporation, Department 63T, Neighborhood Road, Kingston, N.Y. 12401. Comments become the property of IBM.

©Copyright International Business Machines Corporation 1974, 1975, 1976, 1977.



## **Master Table of Contents**

### **Introduction**

3600 System Terminals  
Controller  
Work Station  
Terminal Addressing  
System Configurations

### **Unit Operating Procedures**

Controllers  
Keyboard/Displays  
Printers  
Financial Services Terminals  
Related Units  
Line Units

### **General Operating Procedures**

Basic Commands  
Messages  
Startup, Logon, and Logoff  
Component Testing

### **System Operating Procedures**

General Information  
Complete Commands  
Create Diskette  
Diskette Formatting  
Transmit Diskette  
Display/Print Controller Log  
Display/Print Statistical Counters  
Application Program Modification  
Debug Mode  
Disk File Error Recovery Procedures

### **Problem Recovery**

Problem Recovery Procedures  
Problem Report Sheets

### **Installation Details**

Loop Speed and Address Switches  
Supplies  
Installation Reference Sheets

### **Number Systems and Glossary**

Number Systems  
Glossary

### **Index**







TABS FOR THE

**IBM 3600 Finance Communication System  
Operating Guide**

*Form GA27-2776 (except for revision levels -0, -1, -2, and -3)*

Place all Introduction pages after this tab.



## Contents – Introduction

|                                   |    |
|-----------------------------------|----|
| 3600 System Terminals .....       | 1  |
| Controller .....                  | 1  |
| Application Programs .....        | 2  |
| Controller Storage .....          | 3  |
| Programmable Storage .....        | 3  |
| Diskette (and Disk) Storage ..... | 4  |
| Translation Tables .....          | 4  |
| Work Station .....                | 5  |
| Terminal Addressing .....         | 7  |
| System Configurations .....       | 8  |
| Local and Remote Loops .....      | 8  |
| Central Site Connections .....    | 12 |

This page follows the Introduction tab.





## Introduction

The IBM 3600 Finance Communication System is made up of three parts:

1. A programmable controller and its associated programming and a family of terminals.
2. A communication link, which handles telecommunications between the 3600 locations and between the controller and the central site.
3. A central site, with its computer and associated programming that processes the transactions in coordination with the controller with which it exchanges data.

You, as a control operator, will be working mainly with the controller, terminals, and communication links. Therefore, the rest of this chapter introduces important terms, ideas, and functions that you must know to work with these units.

### 3600 SYSTEM TERMINALS

The terminals making up the 3600 system are the:

- IBM 3604 Keyboard Display
- IBM 3606 Financial Services Terminal
- IBM 3608 Printing Financial Services Terminal
- IBM 3610 Document Printer
- IBM 3611 Passbook Printer
- IBM 3612 Passbook and Document Printer
- IBM 3614 Consumer Transaction Facility
- IBM 3618 Administrative Line Printer

For a description of these terminals, see *Introducing the IBM 3600 Finance Communication System, GA27-2764*; you may wish to put a copy of it in this manual.

The terminals attach to an IBM 3601 or 3602 Finance Communication Controller, and they can be installed within the local facility that has the controller or they can be installed at a remote location away from the controller. The terminals can also attach to an IBM 3603 Terminal Attachment Unit\*, which then communicates with the controller, to provide additional flexibility in setting up remote location configurations. The terminals may be grouped into work stations to do specific jobs or transactions and they may be shared between people and work stations. These points are discussed in more detail later in this subsection.

### CONTROLLER

To handle your institution's transactions and to control the terminals, the controller contains application programs and two kinds of storage: (1) internal programmable storage, and (2) auxiliary or extra storage on a diskette, and, for a 3602, a disk file unit.

---

\*There are three models of the 3603; unless noted otherwise, references to a 3603 are for either a 3603 Model 1 or 3 or a 3603 Model 2 with its associated modem.

## Application Programs

*Application programs*, so called because they handle your institution's *applications* or transactions, are located in programmable storage within the controller. The application programs can direct the controller to do many transactions, such as: (1) simple accounting (e.g., update teller totals) or (2) complex accounting (e.g., update teller totals, determine a branch cash position, update a transaction proof total, and display status messages).

To do these transactions, your institution prepares application programs that:

1. Accept data from and send to the terminals.
2. Process the terminal data. The controller may check for errors in the data entered by an operator, prepare data for sending to the central site, and provide audit trails, teller and branch cash positions, and transaction exercises for teller training.
3. Communicate with the central site. This allows the computer to process transactions immediately or the controller to send data to the computer that it had previously stored within itself. The application programs can control the transfer of data between work stations and the central site.
4. Process data when not in communication with the central site. The controller can be programmed so that operations may continue when the controller cannot communicate with the central site. Transactions that require data from the central site, such as account inquiry, cannot be done by the controller, but transactions can be recorded on the diskette and sent to the central site later.
5. Control the terminals attached to the controller through the use of control characters. The characters do operations such as skipping over parts of printer forms, starting a new page, returning the printing element to the left margin of a form, and moving the printing element or the display cursor to the left or right or up or down.
6. Set up terminal operating characteristics. Each terminal has operating characteristics which can be changed by the application program. These characteristics include such things as the size of printer forms or passbooks, which keys on the 3604 Keyboard Display to use to signal an end of a message, and where on the form or passbook to start printing. These characteristics are initially set up and can be changed as required by the application program. For example, the 3618 printer may normally use forms that have 40 lines and that can fit 60 characters on a line. Sometimes your location may print a payroll for a local business and use checks that have 5 lines of 50 characters each. The application program changes the 3618 characteristics so that the 3618 can print on these checks and then changes back to the original characteristics when the job is done.
7. Turn on lights on the terminals. The 3604, 3606, 3608, 3610, 3611, 3612, and 3618 all have lights that can be defined by your institution and turned on and off by the application program. For example, one of the lights on the 3604 may be defined by your institution as the Encode light and can be turned on whenever the encoder is to be used to write on a magnetic stripe. Also, your institution may have had an audible alarm installed in some of the 3604s to sound with some of these lights.

## Controller Storage

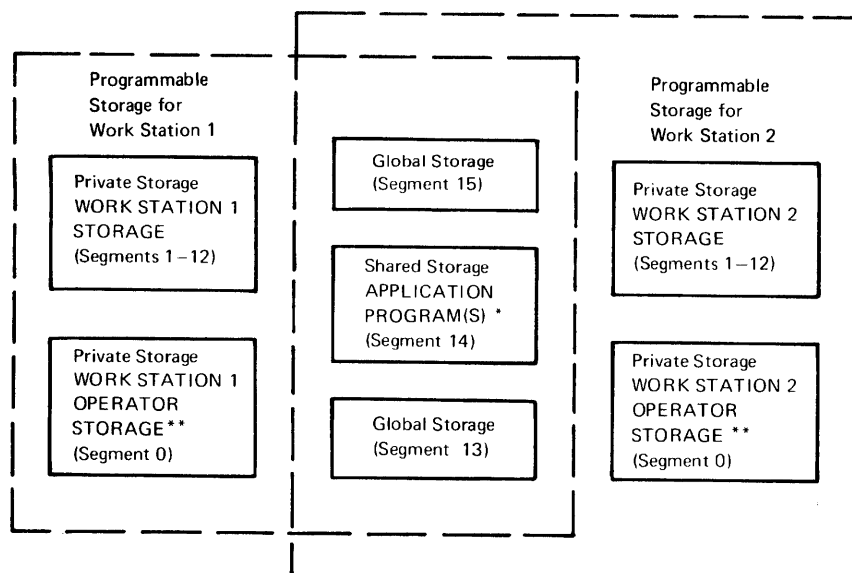
The controller has two kinds of storage:

1. Internal programmable storage for application programs and for work areas associated with the work stations. A basic controller has about 24,000 bytes of programmable storage that can be increased to about 56,000 bytes.
2. Diskette storage, auxiliary, or extra storage in which to store data. About 140,000 bytes can be stored on a one-sided diskette and about 420,000 bytes on the two-sided diskette. In addition, the 3602 can have up to 9.3 million bytes on a disk file unit.

## Programmable Storage

The controller has three kinds of programmable storage: private, global, and shared. Private storage is available only to one work station. This assures that data about a transaction being processed by that work station will not be altered by transactions being processed by other work stations. Global storage is available to all work stations. This storage area contains information such as a list of invalid cashier's checks or the time and date that should be available to all work stations. Shared storage is reserved for the application programs and may be shared between work stations.

The programmable storage is divided into 16 parts called *segments*, numbered from 0-15. Segments 0-12 make up the private storage for each work station. There can be as many of these segments as there are work stations. Segments 13 and 15 are the global storage available to all work stations. There is only one segment 13 and one segment 15 in a controller. There is one segment 14 for each application program, which may be shared between work stations. Each application program, and therefore each segment 14, may be associated with one, some, or all work stations. Figure 1 shows the programmable storage segments and the relationship of these segments to a work station.



\* There is one segment 14 for each different application program.

\*\* There can be two segment 0's per work station.

Figure 1. Relationship of Programmable Storage Segments to a Work Station



## Diskette (and Disk) Storage

Data is stored on the diskette or disk in *tracks*, much like grooves in a phonograph record. The data is stored by types of information, called *records*. A record may be one line on a transaction statement; for example, it could be an account number and transaction; or it may be all of the information filled in on a deposit slip. The tracks and records are numbered; thus, the controller can find any data on the diskette (or disk) by knowing the track and record number of that data.

There are two kinds of diskettes used in the 3600 system: (1) an *operating diskette*, which is used to handle your institution's transactions and which may be a one- or two-sided diskette, and (2) a *starter diskette*, which is a one-sided diskette and is used to initially set up the 3600 system and to create (make) operating diskettes. The following paragraphs discuss the operating diskette. For information about the starter diskette, see "System Operating Procedures."

Operating diskettes are further defined by your institution as *operational* or *nonoperational* during the configuration process. Changes to storage or the diskette are not possible if the diskette is an operational diskette. With nonoperational diskettes, changes to portions of storage or the application programs on the diskette are permitted.

The operating diskette contains an area that is used by the controller to store data. Examples of the data that may be stored in this area by your institution are an audit trail or a record of transactions when the controller cannot communicate with the central site. This information is divided into two files: a *permanent file* and up to four *temporary files*.

A permanent file (maximum size of 256 bytes) contains data that is usually kept from day to day, such as teller IDs, a branch cash position, lists of stolen credit cards, or teller end-of-day cash position.

The temporary files (maximum size of 252 bytes) contain data that is *not* usually kept from day to day, such as a daily audit trail or teller cash position. The controller *log* is a special temporary file; it is used to store messages about the status of the 3600 system. The messages can be read by application programs or displayed by the control operator.

The control operator uses the diskette to start up the controller and can specify either a *cold start* or a *warm start*, depending on whether the information in the temporary files is to be kept or erased. A cold start erases the data in the temporary files but does *not* erase the permanent file. Your institution may decide to do a cold start every morning (to start a new day's work) or whenever the temporary files are filled up with information. A warm start, on the other hand, does *not* erase the data in the temporary files, and the controller continues where it left off. A warm start may be used to restart the controller in the morning or after it has been turned off because of a power loss or a controller problem.

## Translation Tables

To give your institution flexibility, data transferred between the controller and the keyboards, displays, and printers is changed from data meaningful to the terminal to data meaningful to your institution by means of translation tables in the controller. (The 3614 does not use data translation.)

For input to the system, your institution has translation tables for each keyboard. Examples of the functions that these keyboard translation tables can do are:

1. Any meaning can be given to any key. Your institution can choose from several keyboards for the 3604, some with more keys than others, all of which come with engraved keys and blank function keys. Your institution can give any meaning to any key by means of translation tables. Thus, if the needs of your institution change, a new key is not required; they only have to change the translated output for the key. (If a key translates to a character or function other than the one engraved on it, the character or function that the key actually represents should be placed on the key by means of an adhesive label. Sets of printed and blank adhesive keytop labels are supplied with the 3604, and overlay blanks are supplied with the 3606 and 3608.)
2. A function key can identify a transaction. For example, a key could be labeled "DEP" for the teller; pressing this key would tell the controller that the transaction is a deposit.
3. A function key on the 3604 could identify to the controller an operator using a shared keyboard display.
4. One key on the 3604 could be translated to a string of up to seven characters.
5. On alphanumeric keyboards, keys could be identified as repeat-action (typamatic) keys that repeat their function as long as it is held down.
6. Keys on the 3604 could be defined as shift keys to specify different translation tables. The operator switches to a different translation table by pressing one of the shift keys. There are locking shift keys, which cause a translation table to be used until another shift key is pressed, and there are nonlocking shift keys, which cause the translation table to be used only as long as the key is pressed.

In addition, one key must be defined as an end-of-message (EM) or enter key that signals the controller the end of an input from the 3604 keyboard. When the controller sees the EM character, it knows that the operator is finished sending data from the keyboard and it allows the application program to process the message. Two EM (enter) keys, one for each operator, can also indicate which operator is using a shared keyboard display.

For the 3606 and 3608, the function keys are similarly translated into application-defined meanings and the SEND key provides the EM (enter) indication.

For output, your institution could translate data to any one of the characters that can be displayed or printed.

## **WORK STATION**

A work station is one or more terminals and the associated controller storage used by an application program to process transactions (Figure 2). Work stations are defined by your institution at configuration time. Several work stations can be associated with each application program, as discussed above under "Programmable Storage." Under control of the associated application program, all work stations: (1) have access to the diskette, (2) can send

data to other work stations, and (3) can have access to the communication link.

Work stations can perform various types of transactions for your institution. In a commercial bank, for example, there may be four work stations for savings and demand deposit, two for loans, and two for account inquiry. To keep the transaction data separated and to provide individual working areas, each work station is given a separate portion of controller storage. Several work stations can use the same application program, thus eliminating the need for duplicate controller application programs that do the same job. Using the example of the commercial bank, three types of application programs can be used: one for savings, one for demand deposits, and one for loans; or all of the functions can be combined into one application program.

The terminals belonging to a work station can be private or shared. A private terminal is used by only one operator and belongs to only one work station. A shared terminal is either used by more than one operator or belongs to more than one work station. 3604 Keyboard Displays can be shared by two operators using the same work station. In this case, a different end-of-message key may be specified for each operator to tell the controller which operator is using the work station; your institution may use an alternative method.

The 3610, 3611, and 3612 printers can be shared between two work stations. In this case, the printer has two START PRINT keys, one for each operator. When the operator of one work station wants to use the printer, she presses her START PRINT key and the printer becomes part of her work station.

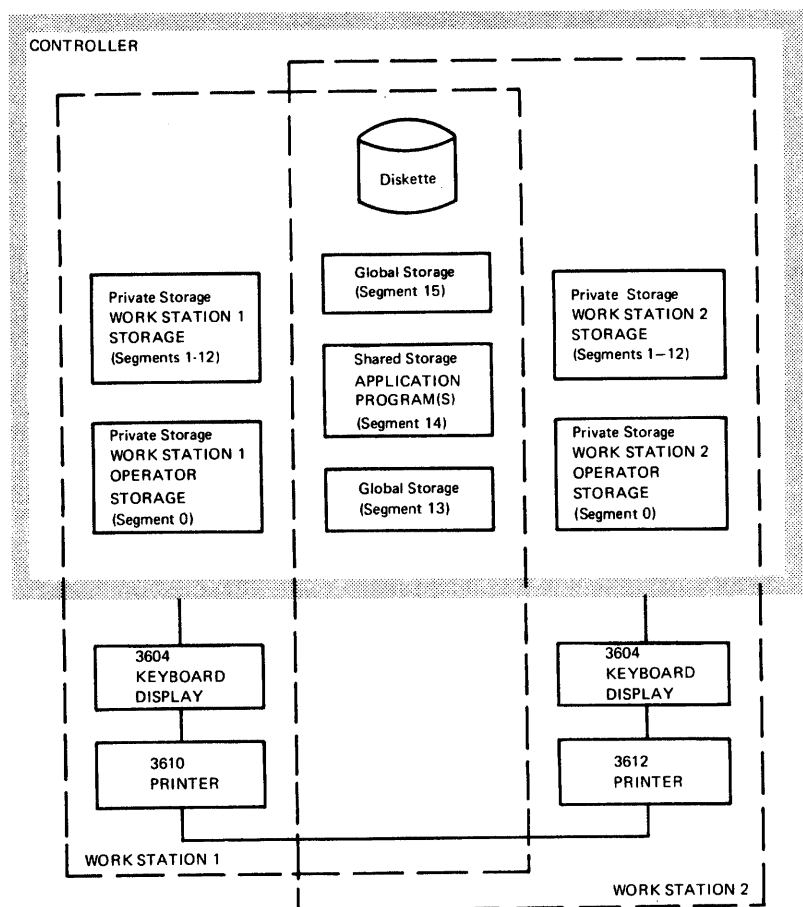


Figure 2. An Example of Work Stations



## TERMINAL ADDRESSING

Each terminal has two addresses: (1) a physical address for each terminal and (2) a logical device address used by the application program for each terminal assigned to a work station.

The physical address identifies each addressable unit in the 3600 system and is made up of three parts:

1. The number of the loop (1-6) to which the terminal is attached.
2. The address (0-15) of the terminal, which is set in the terminal address switches. (See "Loop Speed and Address Switches" under "Installation Details.")
3. The address (0-15) of the terminal component. This address is fixed for each component type. A terminal is made up of one or more addressable components. For example, a 3604 with a magnetic stripe encoder/reader has three addressable components: the keyboard and magnetic stripe reader, the display, and the magnetic stripe encoder. The 3612 printer has two addressable components: the passbook printer and the document printer. The 3608 also has two addressable components: (1) the keyboard, display, and magnetic stripe reader and (2) the printer. All other terminals are addressed as a single component. The addresses of the terminal components are:

| <i>Component Address</i> | <i>Component</i>   |
|--------------------------|--|
| 0                        | reserved   |
| 1                        | 3604 keyboard and magnetic stripe reader                   |
| 2                        | 3604 display   |
| 3                        | 3604 magnetic stripe encoder                               |
| 4                        | 3610 or 3612 document printer or 3618 printer              |
| 5                        | 3611 or 3612 passbook printer                              |
| 6                        | 3606 or 3608 keyboard, display, and magnetic stripe reader |
| 7                        | 3608 printer   |
| 8                        | 3614 terminal  |
| 9-15                     | reserved   |

Thus, for example, a physical address of 1-08-02 identifies on loop 1 a 3604 display whose terminal address is 8. Because each terminal has a unique physical address, the terminals can be placed in different locations on a loop or in different loops.

The Financial Services Terminals are designed so that several of these units, collectively called a *terminal group*, can share a common terminal address on a loop. Each terminal in the group has the same terminal address set in its address switches but has a unique subaddress (0-15) set in additional switches to identify the unit within the terminal address. There can be more than one terminal group, each with its own common terminal address, on a loop.

## SYSTEM CONFIGURATIONS

With the exception of the 3614 Consumer Transaction Facility, all of the terminals are attached to a controller. The controller, in turn, is attached to an IBM 3704 or 3705 Communication Controller. The 3614 can be attached either to a controller or directly to a 3704 or 3705.

### Local and Remote Loops

The terminals are connected to the controller by means of closed loops. Data travels around a loop in one direction, from the controller, through each terminal in turn, and finally back to the controller. Up to eight loops can be attached to some controller models, with a maximum of 16 terminals or terminal groups on one loop. (The maximum number of terminals that can be attached to a controller depends on the application program storage and performance requirements of your institution.) There are two kinds of loops, *local and remote*.

A *local loop* is normally used when the terminals are at the same location as the controller. In a local loop, the loop is made up of cables that run from the controller to the first terminal, then to the next terminal, and so on, and finally back to the controller. Figure 3 illustrates this concept. The cables used have specially shaped connectors to ensure they are correctly connected. (It is recommended that the ends of the cables be labeled to identify the loop and terminals to which each end is to be connected.)

A *remote loop* is used when the terminals are not at the same location as the controller. In this case, a *modem unit* or a 3603 at each location is connected to the controller via a *communications link*. A modem unit is a terminal that has an *integrated modem* (a built-in modem) or can be attached to an external modem.\* The controller can also be a modem unit. The communications link consists of the modems at each location and the interconnecting telephone lines. The remaining terminals at the remote location are connected to the modem unit or 3603 to form a *remote subloop* that is just like a local loop. Figure 4 shows an example of a remote loop with its subloop.

It is possible to have several locations as part of the remote loop, as shown in Figure 5. The terminals at each location are connected with loop cables to form remote subloops, and the subloops are connected by communication links. In this configuration, the remote loop starts at the controller, connects each remote subloop, and finally ends at the controller.

The types of loops may be mixed in a system; Figure 6 shows an example of this.

Each controller has at least one local loop; up to seven other loops (local, remote, or mixed) can be added. Loops can operate at a speed of 600 (not available in the USA), 1200, 2400, or 4800 bps. The 2400- and 4800-bps loop must be a local loop, and up to two 4800-bps local loops may be allowed. Not all loops in a controller have to be of the same speed.

Since all the terminals on a loop are "in series" with each other, the following caution should be observed:

**CAUTION: Pressing the ON/OFF switch of any unit to ON or OFF may cause errors on other terminals if they are in use on the same loop.**

\*The terminals that can have a modem or can be attached to a modem are the 3604 Model 2, 3, or 4 and any 3614 model. (The 3603, as an alternative to a terminal with a modem, provides the necessary modem functions.) The 3606 Model 2 and 3608 Model 2 also have a modem; however, they cannot support a remote subloop.

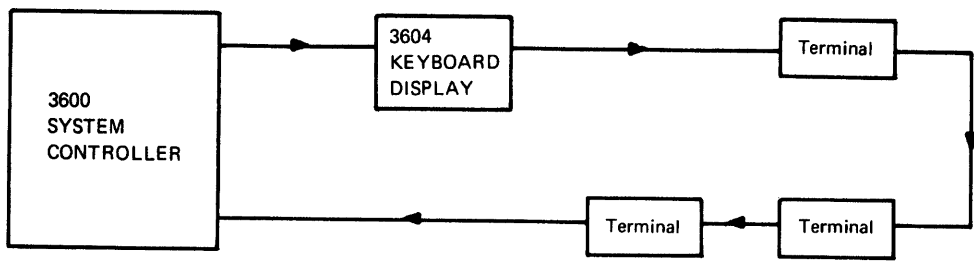


Figure 3. Example of a Local Loop

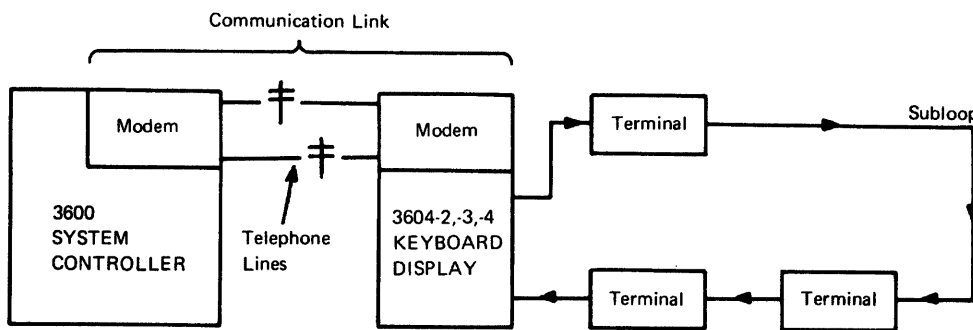


Figure 4. Example of a Remote Loop with One Subloop

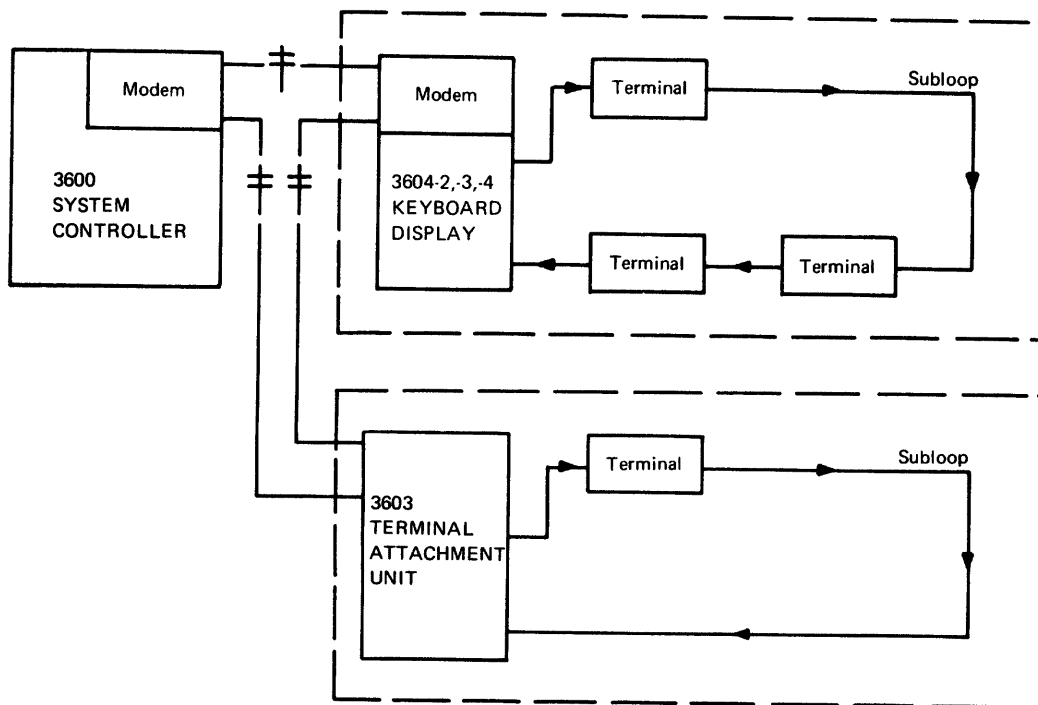


Figure 5. Example of a Remote Loop with More Than One Subloop

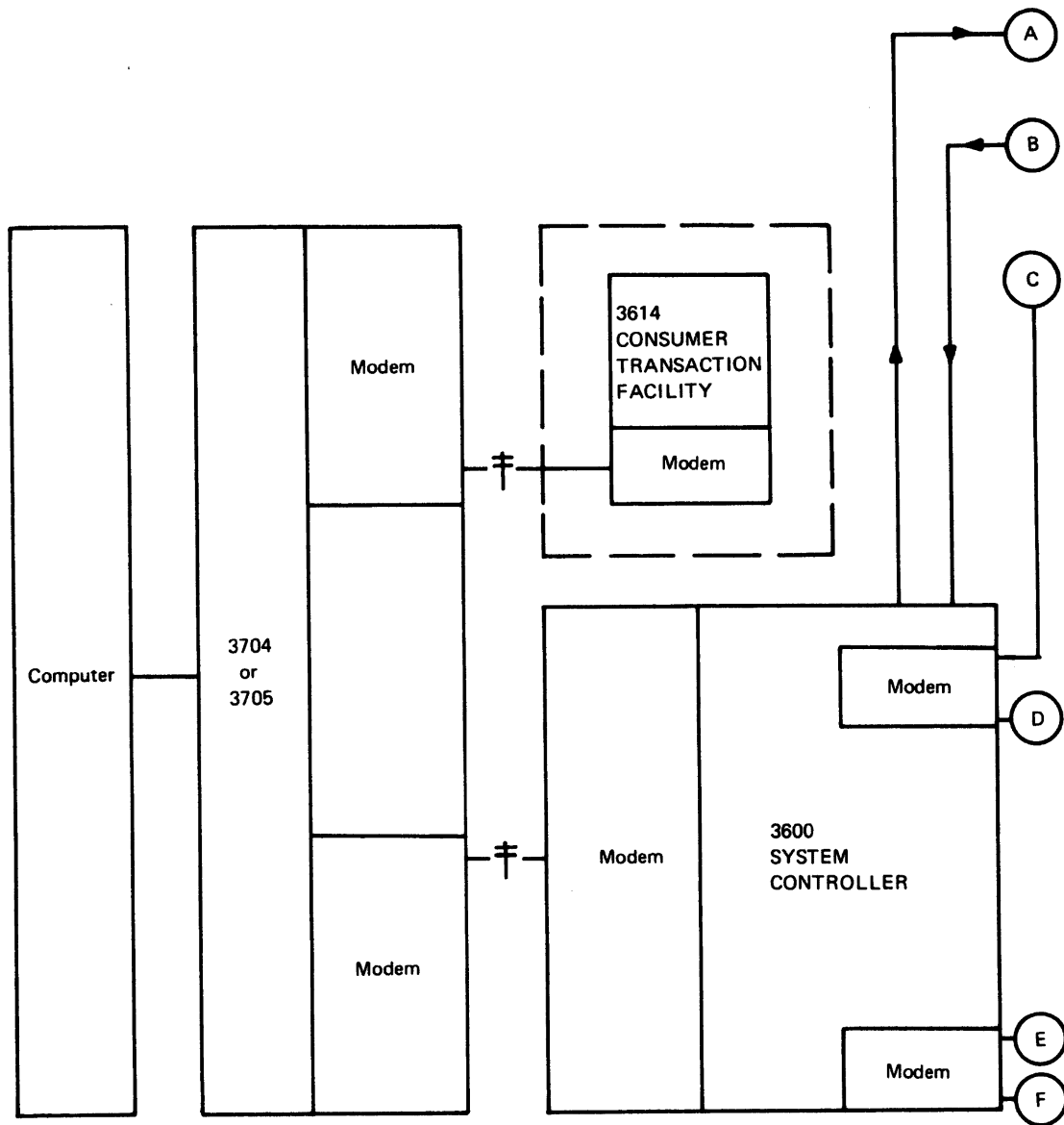


Figure 6. Example of a 3600 System (Sheet 1 of 2)



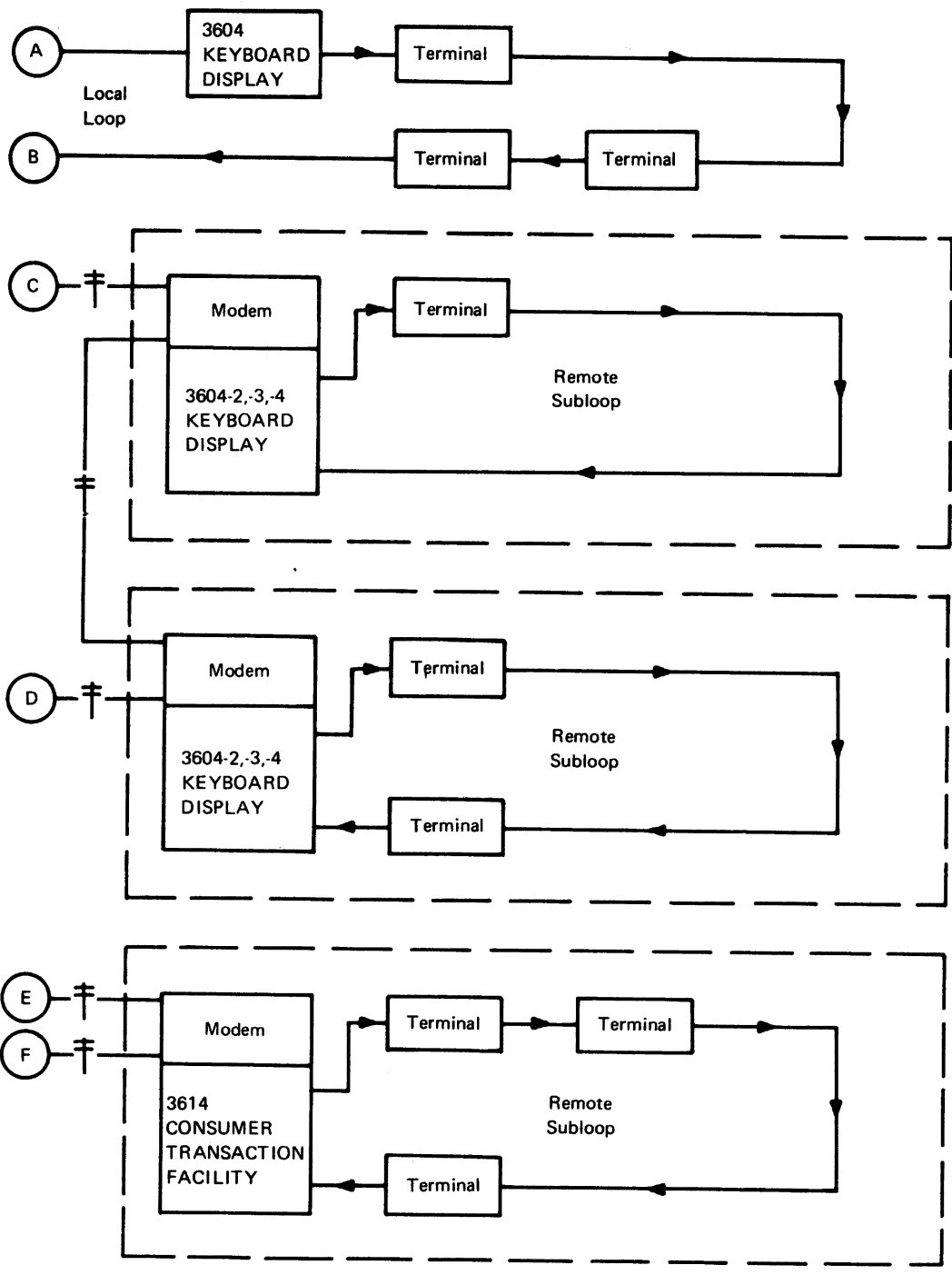


Figure 6. Example of a 3600 System (Sheet 2 of 2)

It is suggested that uniform times be established for turning power on or off at the terminals to minimize the possible errors that may be caused on terminals at other locations but on the same loop.

The loop should not be broken while other terminals on the loop are being used. If a terminal is removed from a loop (as might be required for maintenance or to change a work station setup), the cable ends that connect to that terminal should be plugged together to keep the loop unbroken. The other terminals on the loop can then continue to be used. There is, however, a possible loop cable length problem between units with power on; for details, refer to the *IBM 3600 Finance Communication System Configurator*, GA27-2762.

### **Central Site Connections**

The controller connection to the host system is via a 3704 or 3705 through a communication link. The modem for the controller can be built in to the controller or it can be a stand-alone modem. The 3614 can be attached either to a controller, or directly to a 3704 or 3705 in the same way as the controller is attached to the 3704 or 3705.

Place all Unit Operating Procedures pages after this tab.

## **Contents – Unit Operating Procedures**

### **Controllers**

#### **Keyboard/Displays**

**3604 Keyboard Display**

### **Printers**

**3610 Document Printer**

**3611 Passbook Printer**

**3612 Passbook and Document Printer**

**3618 Administrative Line Printer**

### **Financial Services Terminals**

**3606 Financial Services Terminal**

**3608 Printing Financial Services Terminal**

### **Related Units**

**3614 Consumer Transaction Facility**

### **Line Units**

**3603 Terminal Attachment Unit**

**Loop Repeater (PN 4400002)**

This page follows the Unit Operating Procedures tab.



## Contents – Controllers

|                            |   |
|----------------------------|---|
| Operating Controls .....   | 1 |
| ON/OFF Switch .....        | 1 |
| RESET Switch .....         | 2 |
| The Diskette .....         | 2 |
| Part Numbers .....         | 2 |
| Care of the Diskette ..... | 3 |
| Cleaning Procedures .....  | 5 |
| Operating Procedures ..... | 5 |

This page precedes the Unit Operating Procedures, Controllers page 1.

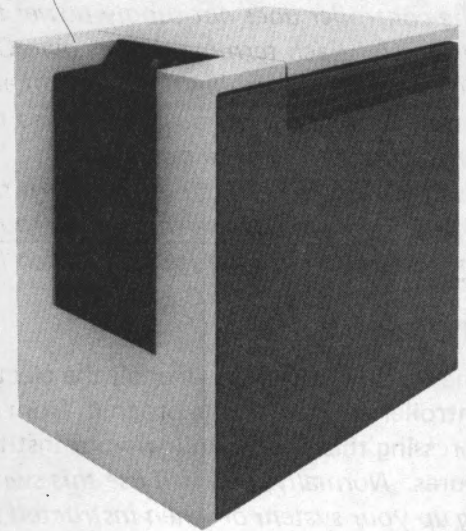




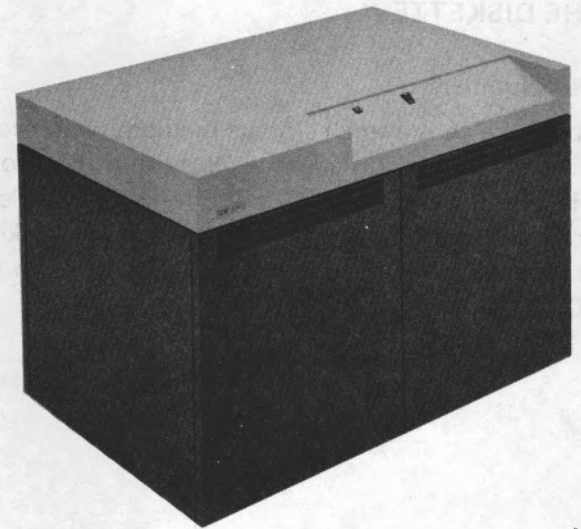
## Controllers

Your controller takes care of all communications between your terminals and your institution's computer center. It keeps records of all the activity at all branches that use the system along with the condition of all the terminals. For a description of the controller, refer to *Introducing the IBM 3600 Finance Communication System, GA27-2764*.

**Note:** *The 3601 has been used for the illustrations in this chapter; the other controllers operate in a similar manner.*



3601



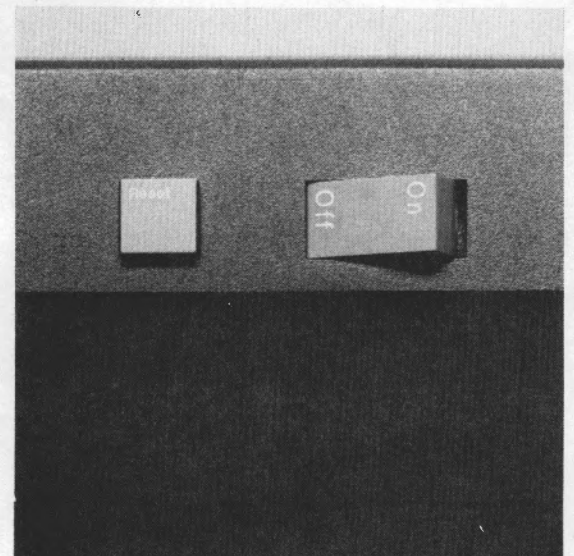
3602

### OPERATING CONTROLS

#### ON/OFF Switch

Press ON of the ON/OFF switch to apply power to the controller. If a diskette has been loaded, it is normal to hear the diskette drive cycling for several seconds when the controller is first turned on.

**CAUTION:** Pressing the ON/OFF switch to ON or OFF may cause errors on other terminals if they are in use on the same loop.



**Notes:**

1. *The controller does not supply power to the 3600 terminals. Each terminal has its own ON/OFF switch. However, the controller does control all of the 3600 terminals, and power must be applied to the controller for the terminals to operate.*
2. *Use the ON/OFF switch only to turn the controller on and off. Do not use this switch to reset and reload the controller; use the RESET switch for that function.*

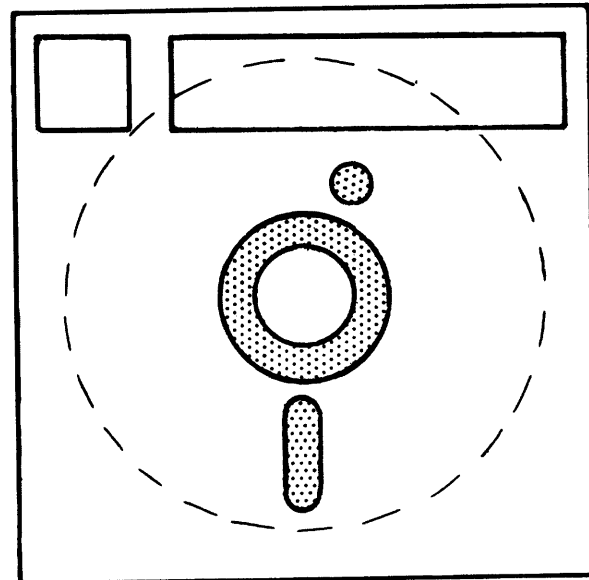
**RESET Switch**

Press the RESET switch to clear all the electronic circuits in the controller and reload the program from the diskette. After pressing this switch, follow your institution's startup procedures. *Normally, you will use this switch only when starting up your system or when instructed to do so by the problem recovery procedures.*

**THE DISKETTE**

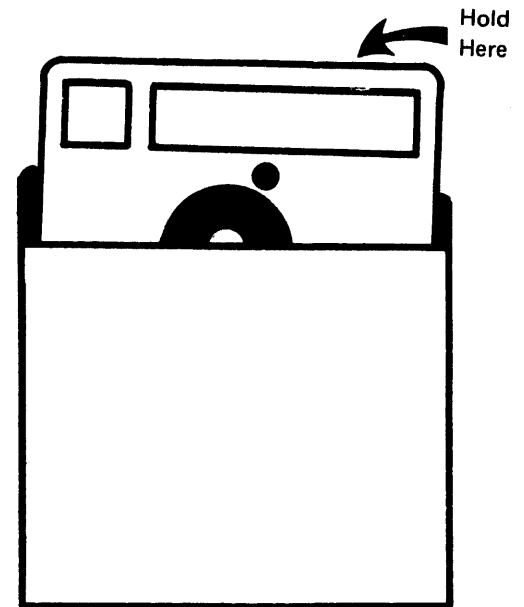
**Part Numbers**

The diskette is a small storage medium which contains electronically recorded data. Note that IBM Formatted Diskette, part number 2305845 for the one-sided diskette or part number 2736700 for the two-sided diskette, is used in the controller; the IBM Starter Diskette part number is 1652106.

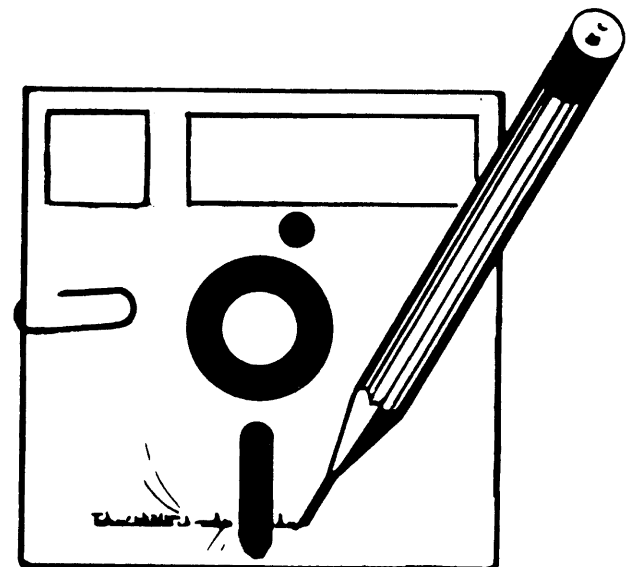


### Care of the Diskette

All of the possible ways to damage diskettes are easily avoided. Develop the *good habit* of always placing diskettes in the storage space provided for them (drawer, rack, etc.) when they're not loaded in the controller. While they are not extremely fragile, diskettes can be easily damaged. When handling the diskette, grasp it only by the top edge.



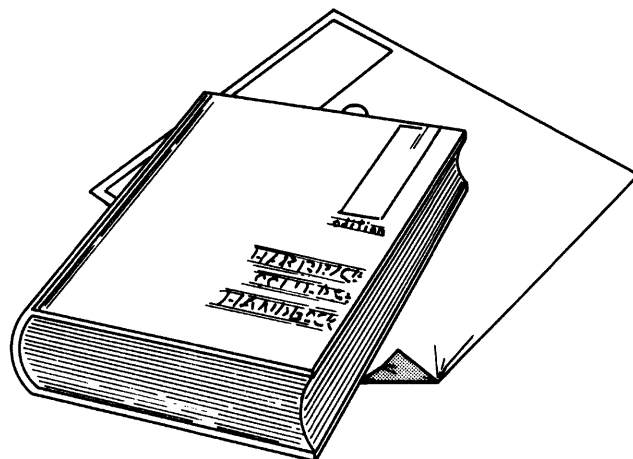
Never write on the diskette. Pencil lead or ink can contaminate the surface and cause errors. The pressure of the pencil point can also damage the surface - even through the outer paper cover. And *never* use paper clips or staples on a diskette.



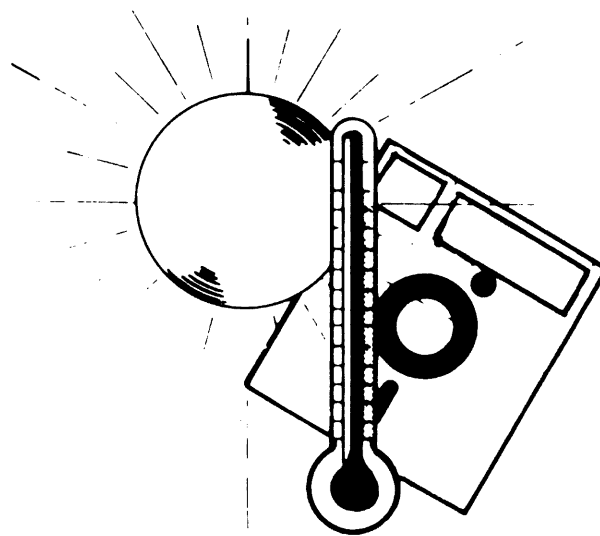
Do not try to clean the surface of a diskette. If it's contaminated (by eraser dust, finger prints, spills or cleaning fluid), discard it. Failure to do so can cause a controller failure and require service before your operations can continue.



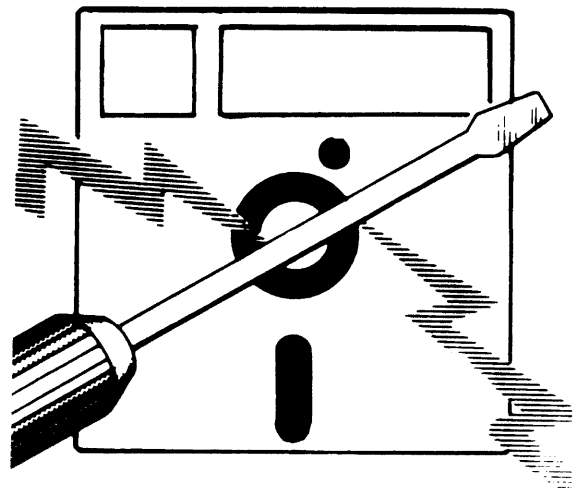
Never place heavy objects on a diskette. Warped, torn, or creased diskettes will not work properly.



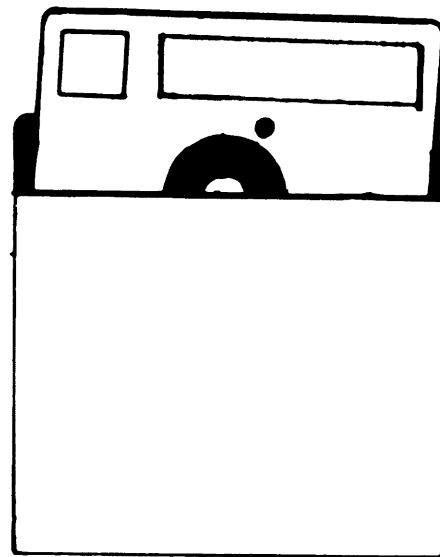
Never expose a diskette to direct sunlight for a long period or to excessive heat.



Always keep diskettes away from magnetic fields or materials.



Always place each of your diskettes in its protective envelope before storing it.



## CLEANING PROCEDURES

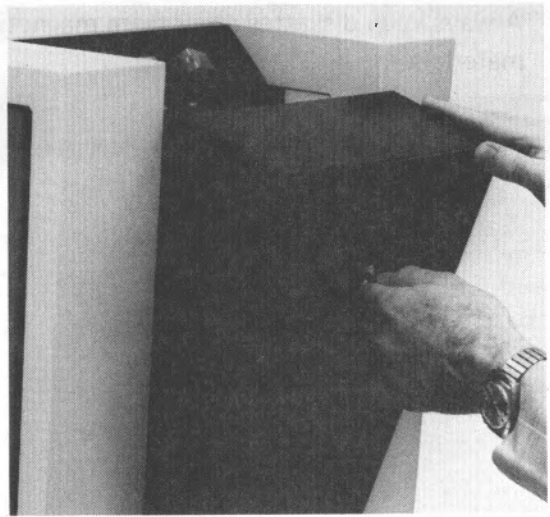
To clean the covers, use warm water and a mild detergent.

## OPERATING PROCEDURES

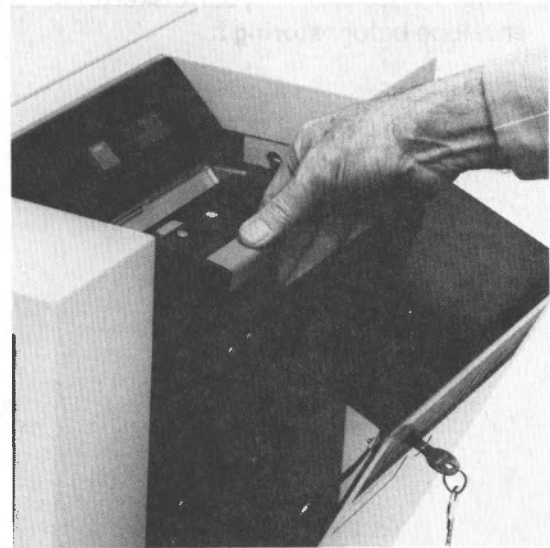
### Loading the Diskette

**CAUTION:** Do not load diskettes that are physically damaged (torn, creased, warped) or contaminated with eraser dust, fingerprints, coffee or other spills, or cleaning fluid. Doing so can result in operating or equipment errors and/or machine damage.

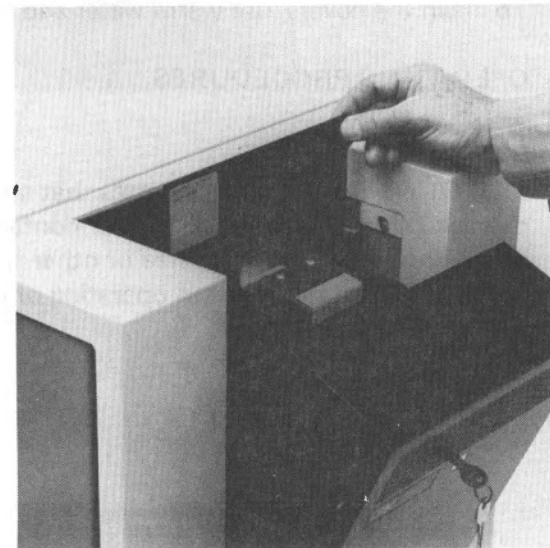
1. Unlock and open the controller's hinged cover to expose the diskette enclosure.



2. Press the latch on top of the diskette drive door to open it. It will pop open about an inch (2.54 cm).

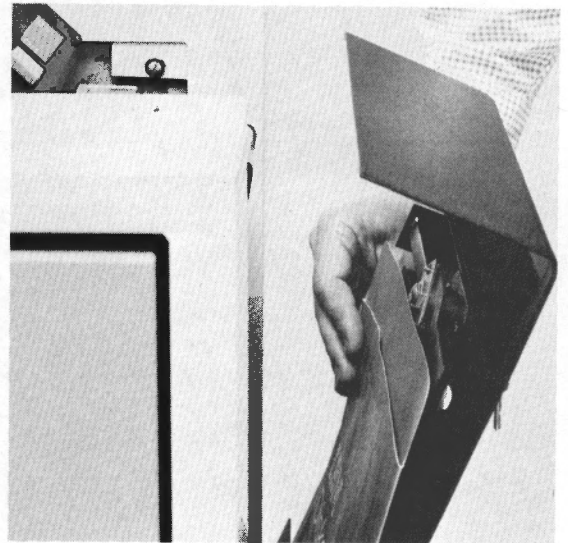


3. Grasp the diskette by its upper edge and remove it from its protective envelope.
4. Check that the diskette is not torn, creased, warped, or contaminated. If it is, discard and replace the diskette.
5. Lower the diskette squarely into the opening at the top of the diskette drive door, with the label facing you. When the diskette reaches the bottom, it is in its normal operating position.
6. Close the diskette drive door until it latches.

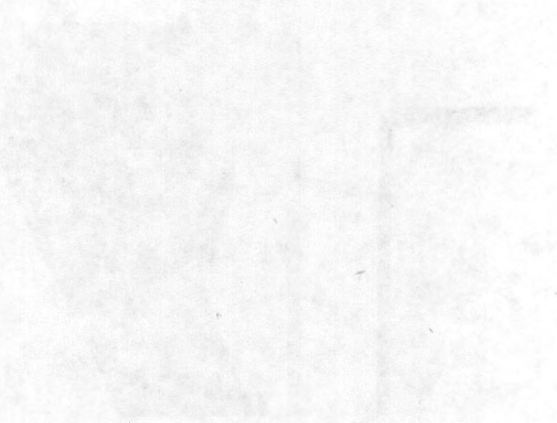




7. Place the diskette's protective envelope in its storage area behind the hinged cover.
8. Close and lock the hinged cover.



Place the diskette in the drive and insert the floppy diskette into the floppy disk drive. Press the floppy disk drive door open button. Close and lock the floppy disk drive door.



## **Contents – Keyboard/Displays**

3604 Keyboard Display

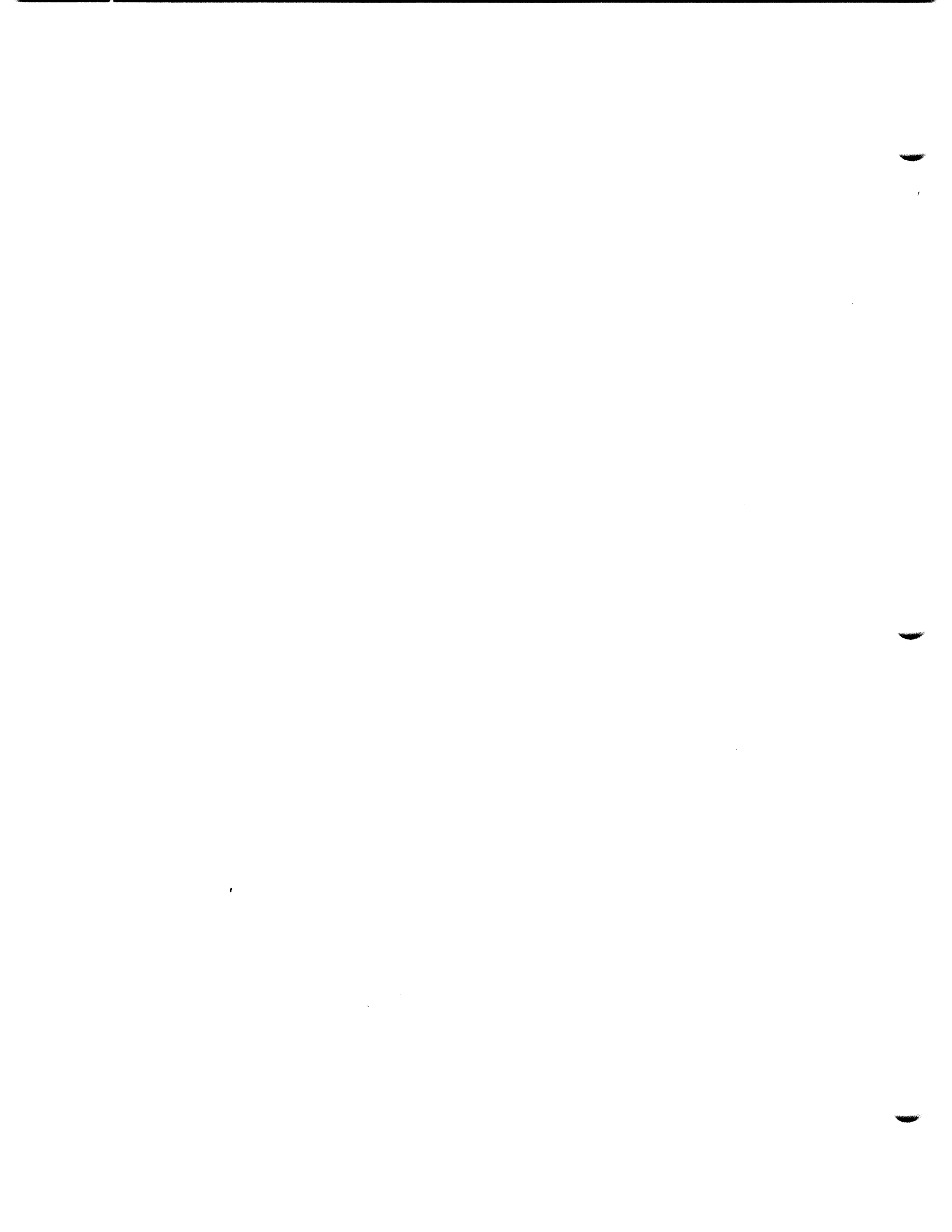
This page precedes the 3604 Keyboard/Display contents page.



## Contents – 3604 Keyboard Display

|  |    |
|--|----|
| Operating Controls and Lights .....              | 1  |
| ON/OFF Switch .....                              | 1  |
| TEST UNIT/DSBL UNIT Switch .....                 | 2  |
| READY Light .....                                | 2  |
| CHECK Light .....                                | 3  |
| 1, 2, and 3 Lights .....                         | 3  |
| Audible Alarm .....                              | 3  |
| Keyboard Keys .....                              | 4  |
| Repeat-Action Keys .....                         | 4  |
| RESET Key .....                                  | 4  |
| SHIFT and LOCK Keys .....                        | 5  |
| ENTER Key .....                                  | 5  |
| ← (Backspace) Key .....                          | 5  |
| Space Bar .....                                  | 5  |
| Advance Key .....                                | 5  |
| Supplies .....                                   | 6  |
| Cleaning Procedures .....                        | 6  |
| Operating Procedures .....                       | 6  |
| Encoding/Reading Magnetic Stripe Documents ..... | 6  |
| Passbooks .....                                  | 7  |
| ID and Credit Cards .....                        | 9  |
| Mounting Magnetic Stripes on Passbooks .....     | 10 |

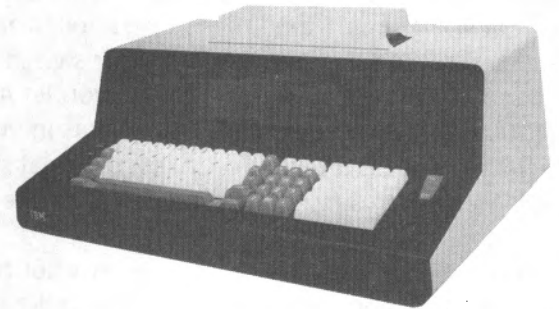
This page precedes the Unit Operating Procedures, 3604 Keyboard Display page 1.



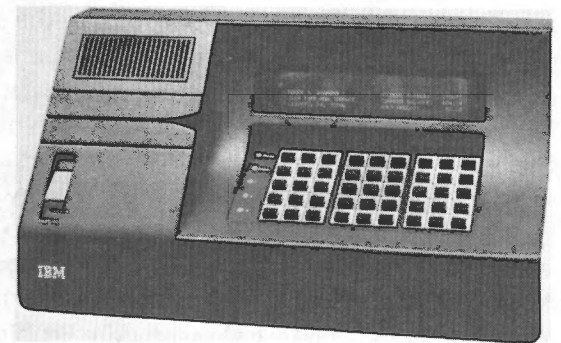
## IBM 3604 Keyboard Display

A basic 3604 consists of a display and a keyboard. Six models are available to provide various combinations of keyboard configurations and display sizes to allow your institution to tailor these units to its specific needs. Your institution can also equip the 3604 with a magnetic stripe reader or, in some models, an encoder/reader. For a description of the 3604 Keyboard Display, refer to *Introducing the IBM 3600 Finance Communication System, GA27-2764*.

**Note:** *The 3604 Model 2 has been used for the illustrations in this chapter; the other models operate in a similar manner.*



3604-2



3604-5

**CAUTION:** The 3604 is cooled by convection; that is, air enters the bottom of the 3604 through louvers (slotted openings) and leaves through the louvers in the top. Make sure nothing covers the louvers to block the passage of air or the 3604 will overheat and fail.

### OPERATING CONTROLS AND LIGHTS

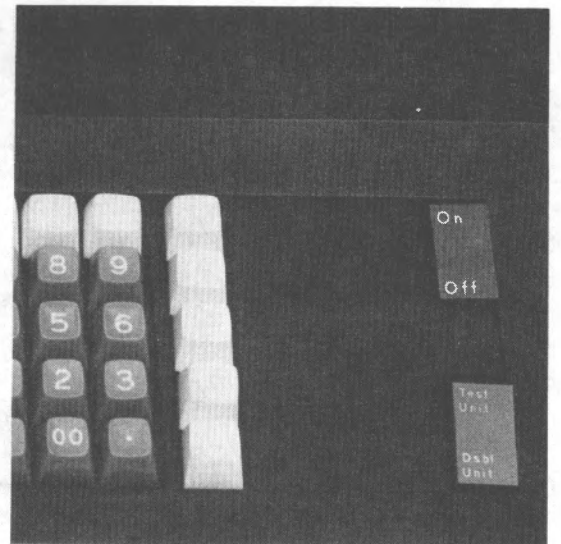
#### ON/OFF Switch

Press ON of the ON/OFF switch to apply power to your 3604. When you are ready to turn off your 3604, simply press OFF. (In some units, the — symbol is used to indicate ON and  $\bigcirc$  to indicate OFF.)

**CAUTION:** Pressing the ON/OFF switch to ON or OFF may cause errors on other terminals if they are in use on the same loop.

Turning the power off, in addition to conserving energy, activates a bypass circuit that functionally removes the unit from the loop without disconnecting the cables. This circuit provides a simple and rapid means to restore the loop operation if the terminal should malfunction.

There is, however, a possible loop cable length problem between the units with power on; for details, refer to the *IBM 3600 Finance Communication System Configurator, GA27-2762*.





## TEST UNIT/DSBL UNIT Switch

This 3-position rocker switch, which is on only the first 3604 on a remote subloop (that is, the 3604 that has the loop integrated modem or an associated external modem), tests the subloop or disables the 3604. Its normal (off) position is the center position. When held in the TEST UNIT position, a signal is sent over the loop cables between all the terminals in your location. If the loop is operating properly, the READY, 1, and 2 lights turn on. This switch automatically returns to the normal position when you let go of it. For a 1200-bps loop, if communications within your location are normal, the READY light on every terminal should be on all the time as long as you hold the switch in the TEST UNIT position.

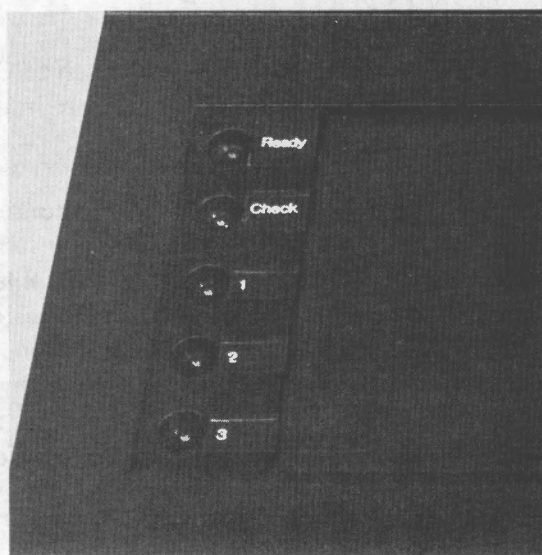
Normal communications between the controller at the local location and your terminal do not take place when TEST UNIT is active. Pressing TEST UNIT makes the complete loop inoperative for as long as you have the switch in that position. Furthermore, when more than one remote location is on a loop, pressing the TEST UNIT switch in any of the locations breaks the communications path between the controller and all the remote locations on that loop. You should place this switch in TEST UNIT only when the Problem Recovery Procedures tell you to do so.

When this switch is in the DSBL UNIT position, the 3604 is removed from the loop and does not operate. You should place it in DSBL UNIT only when the Problem Recovery Procedures tell you to do so.

The remote 3604 may contain an integrated modem that sends information to, and receives it from, the local location. If this 3604 is turned off, then the modem is also turned off and all the terminals in the remote location become inoperative. Therefore, DSBL UNIT allows you to bypass the 3604 when it is the cause of remote location problems but at the same time keep the modem and the rest of the terminals operational.

## READY Light

The condition of the READY light tells you the status of the communications between the 3604 and the controller. When the light is on all the time, there are no communications problems. This is the normal operating state. If the light is *off* all the time or *flashing* on and off, it indicates that there is a communications problem between the 3604 and the controller. When it's *always off*, signals from the controller are not arriving at the 3604. When it's *flashing on and off*, signals from the controller are arriving at the 3604 but signals from the 3604 are not reaching the controller.



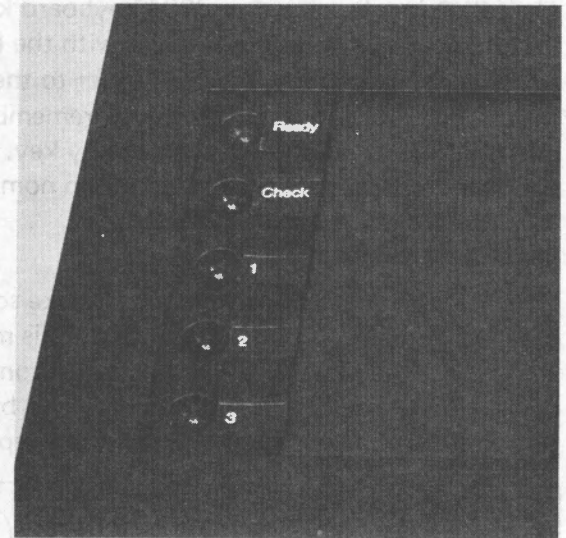
## CHECK Light

The CHECK light tells you that your keyboard and magnetic stripe reader, if you have one, are disabled because of a machine error or special condition. The light comes on as soon as the error or condition is detected. Therefore, you can assume the function you were using caused the light to turn on.

To turn off the CHECK light and activate your keyboard and magnetic stripe reader, press the 3604 RESET key.

If you were using the magnetic stripe reader when the light turned on, pass the document through the slot again.

If the CHECK light comes on too often for you to continue operating, follow your institution's problem reporting procedures.



## 1, 2, and 3 Lights

The name and function of the 1, 2, and 3 lights are determined by your institution. Refer to the description of these lights provided by your institution; it should be placed in this subsection of the operating guide.

One of these lights is defined as an Encode light by your institution to indicate that the magnetic stripe encoder/reader is ready to encode.

On the "control operator 3604" (see "Communicating with the Controller" under "System Operating Procedures" for a discussion of this 3604), one of these lights is used as the Log Message light and is turned on by the controller whenever a controller log message is written that has a 1 as the first character. (See "Display/Print Controller Log" under "System Operating Procedures" for the controller log messages.) The light is defined in the configuration process by your institution. When turned on in this manner, the light will be turned off only after you have read the controller log.

## Audible Alarm

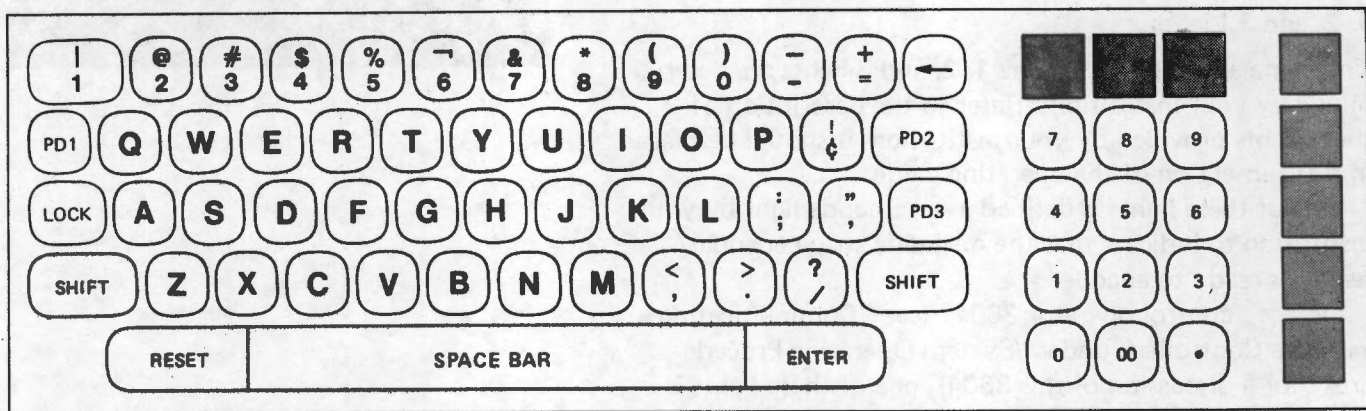
Your institution may have elected to have an audible alarm sound whenever one or more of the function-controlled lights (CHECK, 1, 2, or 3) are turned on. This alarm is to call your attention to the fact that one of these lights has been turned on.

## Keyboard Keys

The following discussion of 3604 keyboard keys assumes that the standard translation table (with the keys defined as they are labeled) is being used (refer to the figure below for the 74-key keyboard). However, remember that your institution can give any meaning to any key. (Labels are available to permit changing the keytop nomenclature.)

## Repeat-Action Keys

Your institution may have chosen to make some of the keys on your keyboard repeat-action keys. This means that these keys repeat their character or function automatically if held down. Check the documentation provided by your institution to determine which of your keys are repeat-action keys.



## 74-Key Keyboard

### RESET Key

When the CHECK light is on, press RESET once to reset the error condition or the special condition and to turn off the light. You can then continue your normal input operation.

When the CHECK light is off, press RESET once to cancel the message that you are entering. All characters keyed since the last end-of-message character was entered are discarded and the keyboard display is reset and ready for a new transaction.

When you are not keying in data from the keyboard but doing some other operation (perhaps using a printer) and you wish to signal "attention" to the application program, press RESET two times.

If, during a magnetic stripe encode operation and after you have entered data and the Encode light (defined by your institution) comes on, you decide not to encode, press RESET two times. This action signals "attention" and releases the application program which can then return the encoder/reader to the read state by issuing a reset to the encoder.

At an idle 3604, press RESET three times to activate the system monitor.



### **SHIFT and LOCK Keys**

When either the left or right SHIFT key is pressed, the upper symbols (on the dual character keys) are entered when their respective keys are pressed. If a character key has no upper symbol (such as the alphabet keys), the uppercase (capital) letter is entered if that key is pressed when the SHIFT key is active. The SHIFT keys are nonlocking and must be held down.

Your institution may define other keys as shift keys to specify different translation tables (see "Translation Tables" under "Introduction"). You switch to a different translation table by pressing one of the shift keys.

Pressing the LOCK key electronically locks the keyboard in an uppercase (shifted) condition. When the LOCK key is used, you don't have to hold the SHIFT key down. Press either SHIFT key to return the keyboard to the lowercase (unshifted) condition. This releases the electronic lock.

### **ENTER Key**

Pressing the ENTER key signals the controller that you have completed the message you were keying and that you are ready for that information to be transferred to the controller.

### **← (Backspace) Key**

Press ← (Backspace) once to backspace one character position (move the cursor back one character position). No information previously keyed is destroyed by backspacing; you can backspace to a wrong character, correct it, advance to where you left off, and continue your work.

### **Space Bar**

Press the Space bar once to move forward one character position (move the cursor ahead one character position). Information previously keyed is destroyed because you are putting in spaces.

### **Advance Key**

Although there is no key engraved "Advance" on the keyboard, your institution can define such a function. The Advance key moves the cursor ahead one character position without destroying previously keyed data.

## SUPPLIES

Supplies for the 3604 are listed under "Installation Details."

## CLEANING PROCEDURES

To clean the amber display window, use isopropyl alcohol. Apply with a soft clean cloth, being careful not to scratch the window.

To clean the magnetic stripe on a card, use isopropyl alcohol and a clean cloth; do not clean the stripe on the passbooks.

To clean the covers, use warm water and a mild detergent.

## OPERATING PROCEDURES

### Encoding/Reading Magnetic Stripe Documents

The information contained on the magnetic stripes mounted on passbooks or ID or credit cards is communicated to the controller by sliding those documents through the reader or encoder/reader slot on top or front of the 3604.

When a document with a magnetic stripe is passed through the reader, the stripe is read. When passed through the encoder/reader, the stripe is read if the encoder/reader is in the Read state, and the stripe is encoded if the encoder/reader is in the Encode state. 3604 encoding is in a format that is different from standard ABA encoding. Therefore, credit cards cannot be encoded to ABA specifications and can only be read.

**CAUTION:** Never pass material other than the magnetic stripe documents through the slot in the reader or encoder/reader. The mechanism which reads or encodes the stripe could be damaged, making the machine inoperative and possibly resulting in an expensive repair. For the same reason, remove all foreign materials (such as staples, paper clips, and rubber bands) from the magnetic stripe documents before you pass them through the slot.

One of the programmable lights (1, 2, 3) on a 3604 that has an encoder/reader is defined as an Encode light by your institution to indicate that the encoder/reader is ready to encode. To encode a magnetic stripe, proceed as follows:

1. Enter the data to be encoded on your keyboard and press the ENTER key.
2. If the data is good, the Encode light will turn on.
3. Wait for the Encode light to turn on; do not proceed until this light turns on.
4. Pass the document through the slot (see the illustrated procedure below).
5. If the encode operation is successful, the Encode light will turn off and the encoder/reader will return to the Read state.

After you have entered data on the keyboard and pressed the ENTER key, the Encode light turns on. At this point you may decide not to encode; press the RESET key two times. This action signals "attention" and releases the application program, which can then return the encoder/reader to the read state by issuing a reset to the encoder.

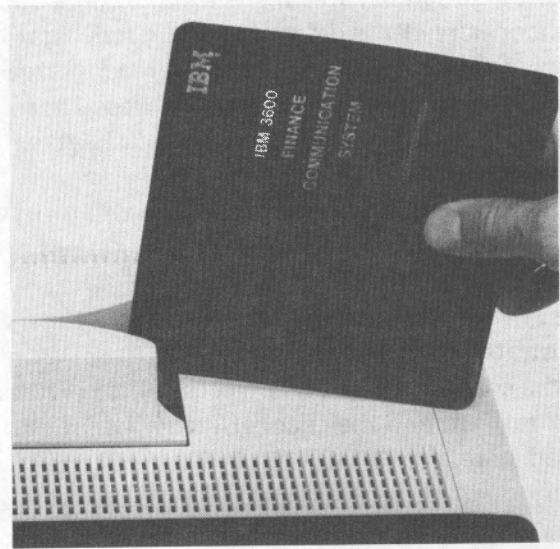
If the Encode light turns on (indicating you entered good data) but something happens when you pass the stripe through the slot (perhaps the stripe can't be encoded because it is scratched), the Encode light turns off. The encoder/reader will return to the Read state and an error is indicated to the application program.

**Note:** *The encoder/reader returns to the Read state after a document is passed through the slot, whether or not the stripe has been encoded successfully.*

#### **Passbooks**

You must pass passbooks through the slot from right to left. *Open the passbook so that only the cover with the magnetic stripe passes through the slot.*

1. Open the passbook, grasp it near the fold so that the magnetic stripe is facing you along the bottom edge, and position the bottom edge of the passbook flat against the bottom of the entrance to the slot.

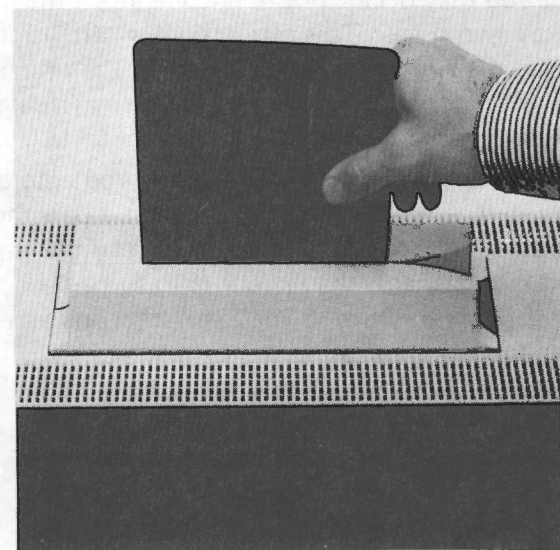


2. Slide the passbook through the slot in a smooth, easy motion. The mechanism is designed to handle a wide variation of speed; however, best results can be obtained when the entire pass takes between 1 and 3 seconds to complete.

**Note:** *It's normal to feel some drag on the passbook as you slide it through the slot. Pressure rolls inside the slot press the magnetic stripe against the read/write mechanisms.*

3. The operation is complete when the entire passbook slides out the left end of the slot.

If an error occurs, the 3604 CHECK light will come on. If this happens, press the 3604 RESET key to turn off the CHECK light, and repeat the operation.

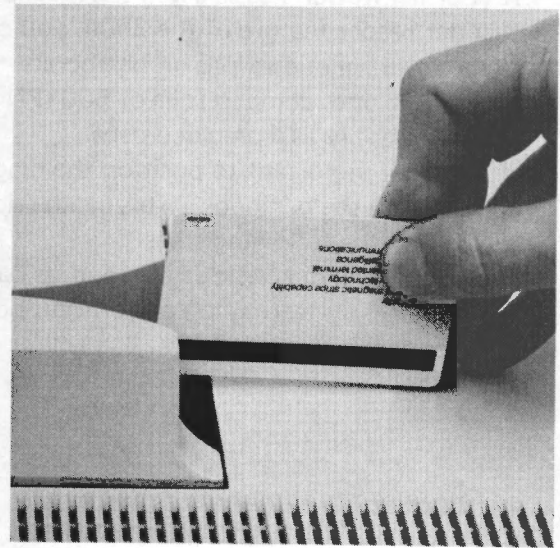




## ID and Credit Cards

You must pass cards through the slot from right to left.

1. Grasp the card with the stripe facing you along the bottom edge of the card, and position the bottom edge of the card flat against the bottom of the entrance to the slot.

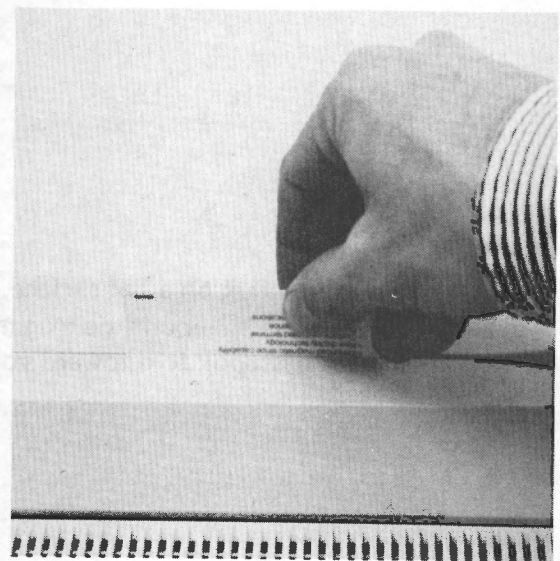


2. Slide the card through the slot in a smooth, easy motion. The mechanism is designed to handle a wide variation of speed; however, best results can be obtained when the entire pass takes between 1 and 3 seconds to complete.

**Note:** *It's normal to feel some drag on the card as you slide it through the slot. Pressure rolls inside the slot press the magnetic stripe against the read/write mechanisms.*

3. The operation is complete when the entire card slides out the left end of the slot.

If an error occurs, the 3604 CHECK light will come on. If this happens, press the 3604 RESET key to turn off the CHECK light, and repeat the operation.



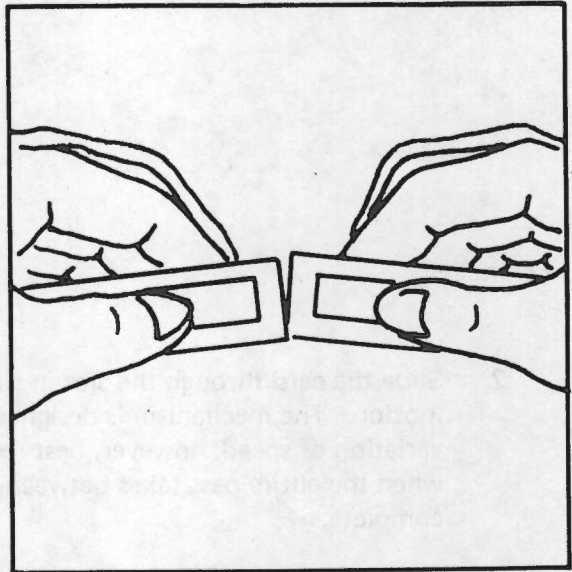


### Mounting Magnetic Stripes on Passbooks

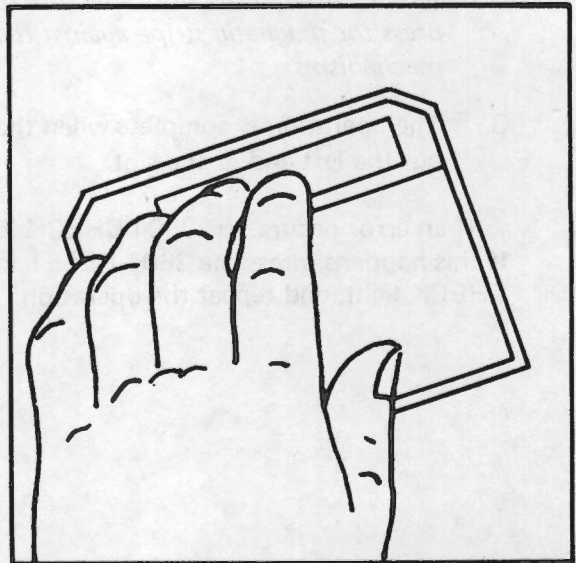
If your institution has selected the magnetic stripe reader or encoder/reader feature of the 3604, you could be required to mount magnetic stripes on passbooks. IBM-manufactured magnetic stripes come in rolls of 500 (PN 428650) and are as easy to apply as a preglued decal.

It is very important to position the magnetic stripe correctly on the passbook. This can be done easily and quickly by the following steps:

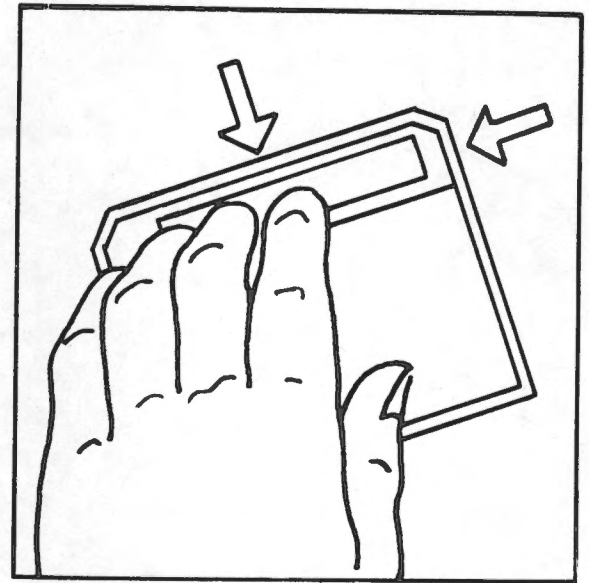
1. Remove a magnetic stripe (and its backing paper) from the roll by tearing the perforation between magnetic stripes.



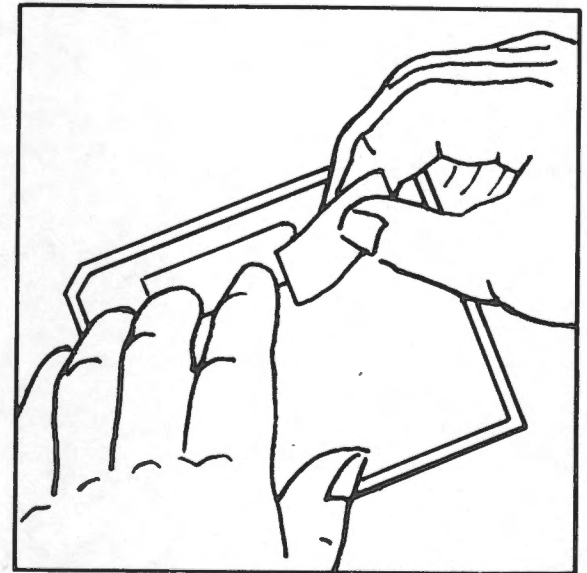
2. Place the passbook on a flat surface, with the cover on which you wish to mount the magnetic stripe facing up and the passbook fold toward you.



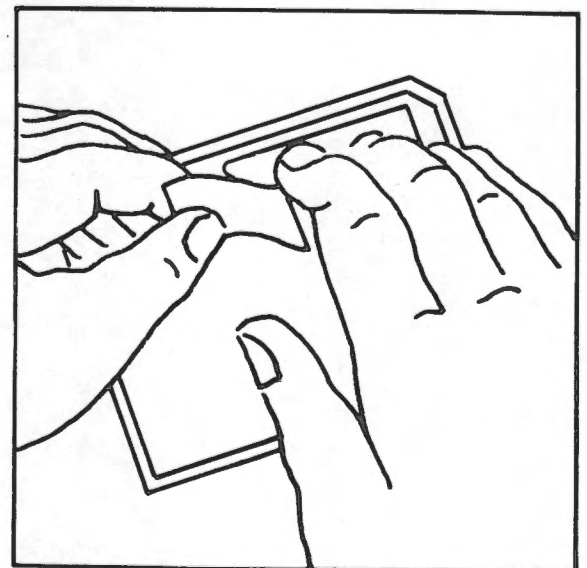
3. Lay the magnetic stripe (with the backing paper still on it) at the far right corner of the passbook with the magnetic stripe up.
4. Align the right and rear edges of the backing paper with the same edges of the passbook cover. Keeping these edges aligned while mounting the magnetic stripe ensures correct positioning of the stripe on the passbook.
5. Keep the backing paper edges aligned by pressing firmly on the left half of the magnetic stripe with several fingers of your left hand.



6. With your right hand, peel the right half of the backing paper from under the right end of the magnetic stripe (the backing paper is split near the middle of the magnetic stripe).
7. Keeping the remaining backing paper aligned with the passbook edge, slide a finger over the right end of the magnetic stripe to stick it to the passbook.



8. Peel the remaining backing paper from under the left end of the magnetic stripe. Slide your thumb or finger firmly from right to left over the length of the magnetic stripe.



The magnetic stripe should now be in place with no bends or wrinkles and its edges should be parallel with the edges of the passbook. The adhesive substance on the magnetic stripe allows removal of the stripe for up to 2 or 3 hours after mounting. If for any reason the stripe is not positioned correctly, it should be peeled off the passbook immediately, discarded, and another mounted. Stripes that have been in place for longer periods are very difficult to remove.



## **Contents – Printers**

- 3610 Document Printer**
- 3611 Passbook Printer**
- 3612 Passbook and Document Printer**
- 3618 Administrative Line Printer**

This page precedes the 3610 Document Printer contents page.



Document - 10/1/78

3811 Document  
3811 Document  
3811 Document and Document  
3811 Document

## Contents – 3610 Document Printer

|  |    |
|--|----|
| <b>Models 1, 2, and 3</b> .....                              | 1  |
| Operating Controls and Lights .....                          | 1  |
| ON/OFF Switch .....  | 1  |
| START PRINT and STOP PRINT Switches .....                    | 1  |
| READY Light .....  | 2  |
| 1 and 2 Lights .....   | 2  |
| Cut Forms Margin Guide .....                                 | 2  |
| Cut Forms Stop Selector .....                                | 3  |
| Forms Advance Knob, Continuous Forms Printer (Model 3) ..... | 3  |
| Forms Advance Knob, Journal Roll Printer (Model 2) .....     | 3  |
| Forms Control Rod, Journal Roll Printer (Model 2) .....      | 4  |
| Supply Roll Guide, Journal Roll Printer (Model 2) .....      | 4  |
| Supplies .....   | 4  |
| Cleaning Procedures .....                                    | 5  |
| Operating Procedures .....                                   | 5  |
| Opening the Cover .....                                      | 5  |
| Closing the Cover .....                                      | 6  |
| Inserting Cut Forms .....                                    | 7  |
| Journal Roll Removal .....                                   | 8  |
| Loading Journal Rolls .....                                  | 9  |
| Loading Continuous Forms .....                               | 14 |
| Ink Roll Removal .....                                       | 19 |
| Ink Roll Replacement .....                                   | 20 |
| Cleaning the Print Wheel .....                               | 22 |
| Print Wheel Wiper Removal .....                              | 24 |
| Print Wheel Wiper Replacement .....                          | 25 |
| <b>Models 4 and 5</b> .....                                  | 26 |
| Operating Controls and Lights .....                          | 26 |
| ON/OFF, Start, Stop Switches and READY, 1, 2 Lights .....    | 26 |
| Cut Forms Stop Selector .....                                | 26 |
| Forms Advance Knob .....                                     | 26 |
| Forms Control Rod .....                                      | 26 |
| Supply Roll Guide .....                                      | 27 |
| Cleaning Procedures .....                                    | 27 |
| Operating Procedures .....                                   | 27 |
| Opening and Closing the Covers .....                         | 27 |
| Inserting Cut Forms .....                                    | 28 |
| Journal Roll Removal .....                                   | 28 |
| Loading Journal Rolls .....                                  | 29 |
| Ink Roll Removal .....                                       | 32 |
| Ink Roll Replacement .....                                   | 33 |
| Cleaning the Print Wheel .....                               | 34 |
| Print Wheel Wiper Removal .....                              | 35 |
| Print Wheel Wiper Replacement .....                          | 36 |

This page precedes the Unit Operating Procedures, 3610 Document Printer page 1.





## IBM 3610 Document Printer

The 3610 printer can print on journal rolls, continuous forms, or cut forms. Your institution can choose from five models of 3610s to get the combination of forms desired. For a description of the 3610 Document Printer, refer to *Introducing the IBM 3600 Finance Communication System*, GA27-2764.

### Notes:

1. *The journal rolls usually have the last three or four feet overprinted in red to indicate the end of the roll; to prevent loss of information, replace the journal roll as soon as the overprint mark appears.*
2. *The 3610 Models 2 and 3 have been used for the illustrations in the first part of this subsection; the operation of the Model 1 is similar. The second part of this subsection describes the unique portions of the Models 4 and 5.*

### MODELS 1, 2, AND 3

#### OPERATING CONTROLS AND LIGHTS

##### ON/OFF Switch

Press ON of the ON/OFF switch to apply power to your 3610. When you want to turn off the 3610, simply press OFF. (In some units, the — symbol is used to indicate ON and O to indicate OFF.)

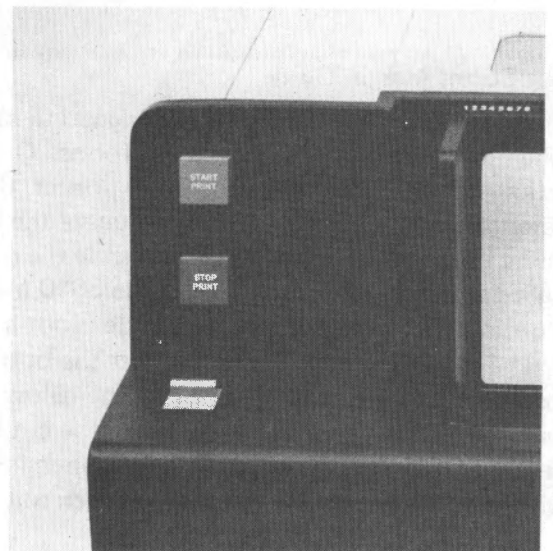
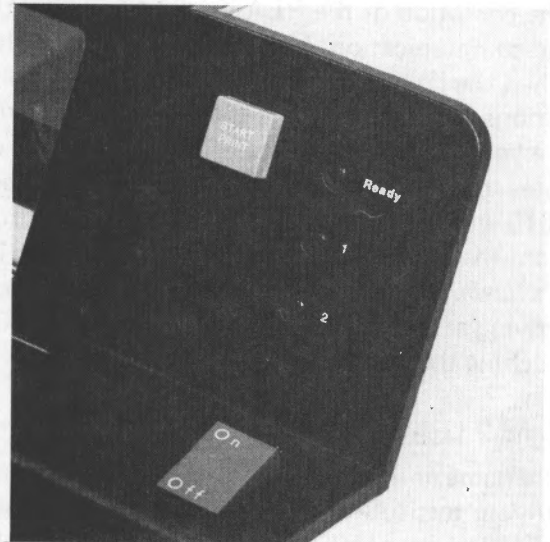
**CAUTION:** Pressing the ON/OFF switch to ON or OFF may cause errors on other terminals if they are in use on the same loop.

Turning the power off, in addition to conserving energy, activates a bypass circuit that functionally removes the unit from the loop without disconnecting the cables. This circuit provides a simple and rapid means to restore the loop operation if the terminal should malfunction.

There is, however, a possible loop cable length problem between the units with power on; for details, refer to the *IBM 3600 Finance Communication System Configurator*, GA27-2762.

##### START PRINT and STOP PRINT Switches

Press the START PRINT switch when you want to start printing. Paper must be in the printer, or a cut form must be inserted first. Pressing the START PRINT switch tells





the controller that the 3610 is ready for the printing operation to start and activates the printer. When the START PRINT switch is pressed, the platen is closed and the motor is turned on, which starts the print wheel turning. (If no data is received from the controller application program within 20 seconds, the platen is opened and the motor is turned off.)

When the 3610 is a shared printer, there are two START PRINT switches, one assigned to each work station. They are located on opposite sides of the printer and operate as described above.

Press the STOP PRINT switch to stop any printing that is in progress on the 3610. When you press this switch, the motor stops, which stops the print wheel, and the cut form is released.

### READY Light

The condition of the READY light tells you the status of the communications between the 3610 and the controller. When the light is on all the time, there are no communications problems. This is the normal operating state. If the light is *off* all the time or *flashing* on and off, it indicates that a communications problem exists between the 3610 and the controller. When it's *always off*, signals from the controller are not arriving at the 3610. When it's *flashing on and off*, signals from the controller are arriving at the 3610 but signals from the 3610 are not reaching the controller.

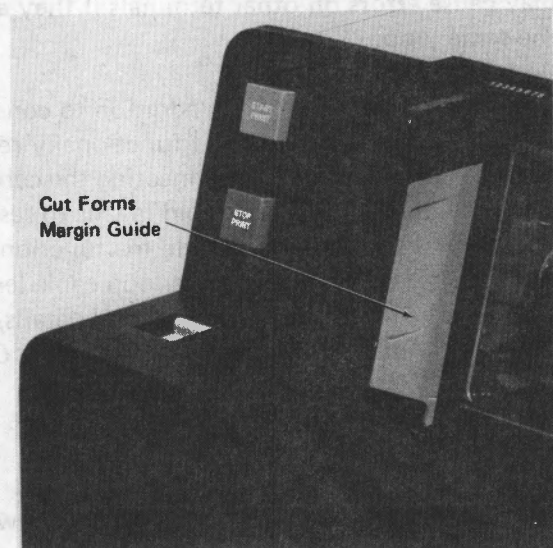
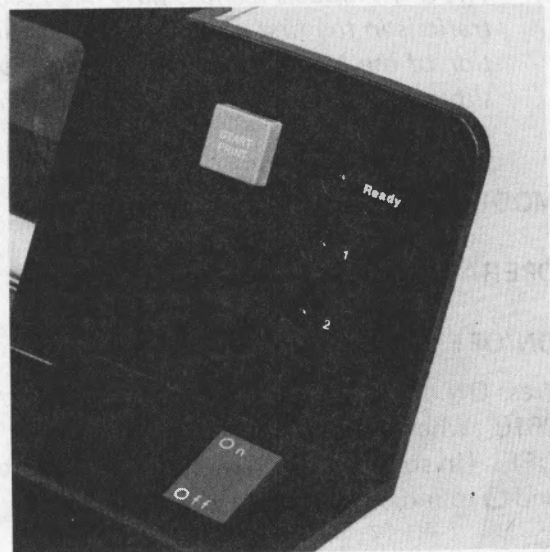
### 1 and 2 Lights

The name and function of the 1 and 2 lights are determined by your institution. Refer to the description of these lights provided by your institution; it should be placed in this subsection of the operating guide.

### Cut Forms Margin Guide

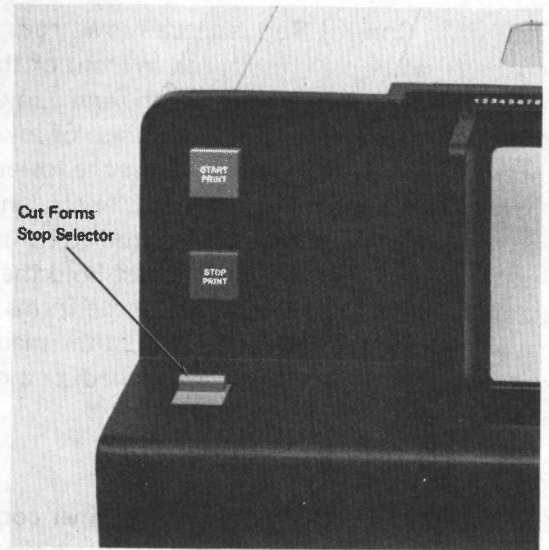
The Cut Forms Margin Guide is designed to save you time when inserting and positioning cut forms. On Models 1 and 2 (journal roll printers) of the 3610 printer, the guide can be set to any of eight positions. Squeeze the light blue insert in the guide toward you and slide the guide left or right to the desired position. On the 3610 Model 3 printer (continuous forms printer), the guide is not adjustable.

The small white scribed mark near the bottom of the blue insert is the same height as the red line below the viewing window. Together with the mark on the cut form, they can be used for proper forms positioning when inserting forms with the Cut Forms Stop Selector switch not engaged.



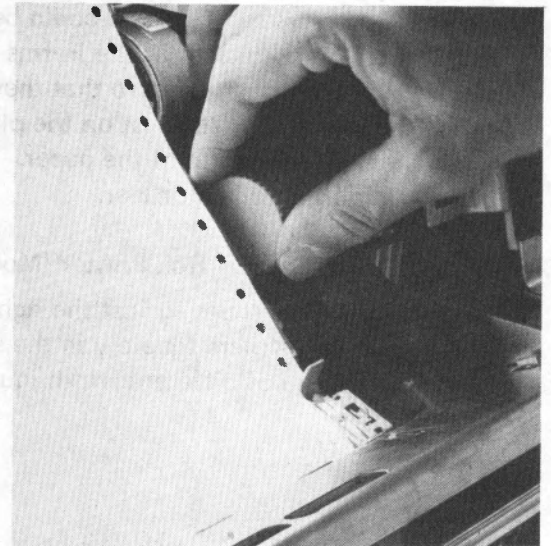
### Cut Forms Stop Selector

The Cut Forms Stop Selector is a two-position slide switch. When the slide switch is in the rear position, the depth that cut forms can be inserted into the printer is limited. In the forward position, the depth of insertion of cut forms is not limited.



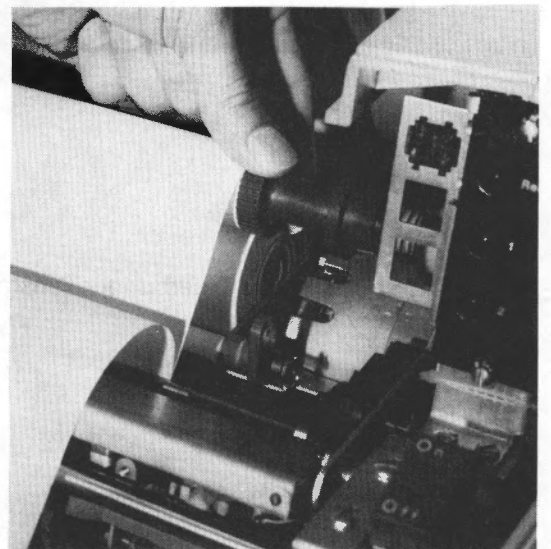
### Forms Advance Knob, Continuous Forms Printer (Model 3)

Turn this knob to move the continuous forms forward in small increments.



### Forms Advance Knob, Journal Roll Printer (Model 2)

Turn this knob to move the journal roll forward in small increments.



### Forms Control Rod, Journal Roll Printer (Model 2)

The Forms Control Rod is actually two rods that move together: an upper control rod in front of the platen (this rod can be seen in the photograph) and a lower control rod in back of the platen. When you raise or lower the upper control rod, you also raise or lower the lower control rod.

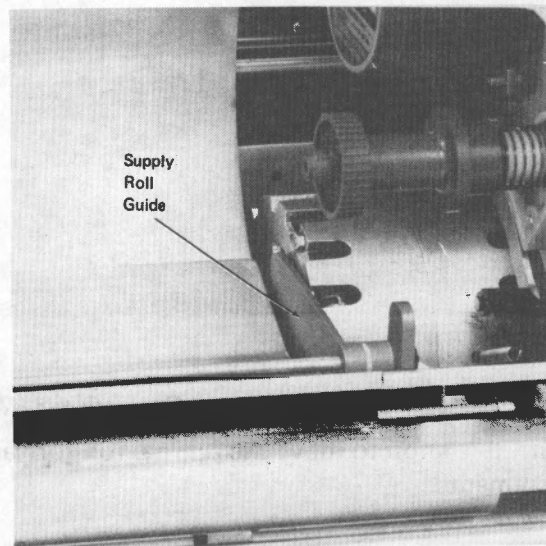
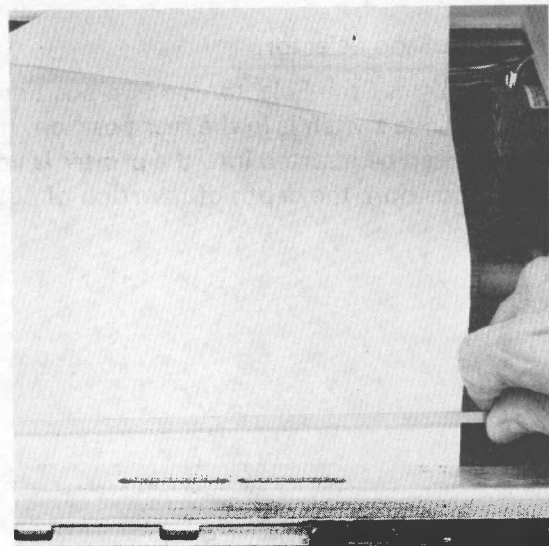
When you want to load, unload, or straighten the journal, you must raise the upper control rod to its upper stop. In that position, the pressure rolls that hold the paper against the platen are out of the way, and the forms path through the printer is open. Paper already in the machine is then loose and can be removed or realigned, or a new journal can be loaded.

### CAUTIONS:

1. Be careful when lowering the upper control rod after you have loaded the journal. The pressure rolls can snap the paper tightly against the platen. The journal is pressure-sensitive and could be marked.
2. The spacers on both sides of the Forms Control Rod should always be positioned so that they do not touch the journal but still rest on the platen. Never move them into the path of the paper. They can cause the journal to jam or tear.

### Supply Roll Guide, Journal Roll Printer (Model 2)

The Supply Roll Guide slides against the right end of journal rolls and keeps them squarely in the supply roll tray. It allows the use of different width journal rolls.



### SUPPLIES

Supplies for the 3610 are listed under "Installation Details."



## CLEANING PROCEDURES

To clean the viewing window and the covers, use warm water and a mild detergent.

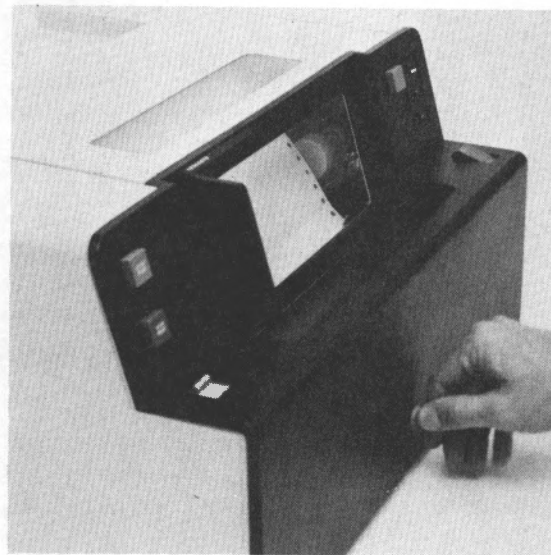
## OPERATING PROCEDURES

### Opening the Cover

The 3610 cover must be opened to do many of the procedures that follow.

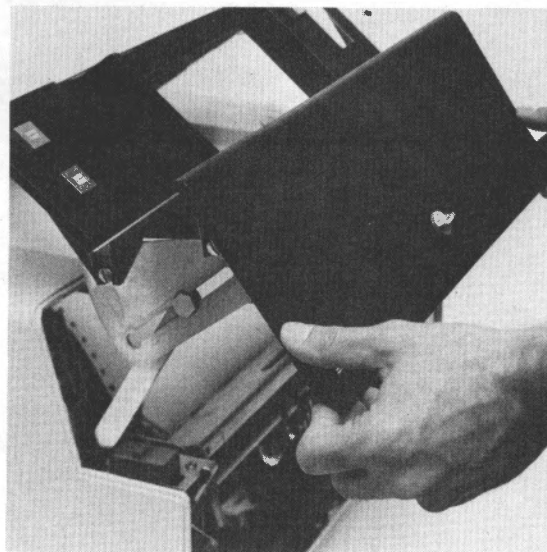
**Note:** *There is an interlock to disable the 3610 when the cover is open; be sure the printwheel has stopped turning before proceeding.*

1. Turn the cover latch to the right to a horizontal position.



2. Lift the top cover, in one motion, until the support brackets snap into their stops at the cover's upper limit.

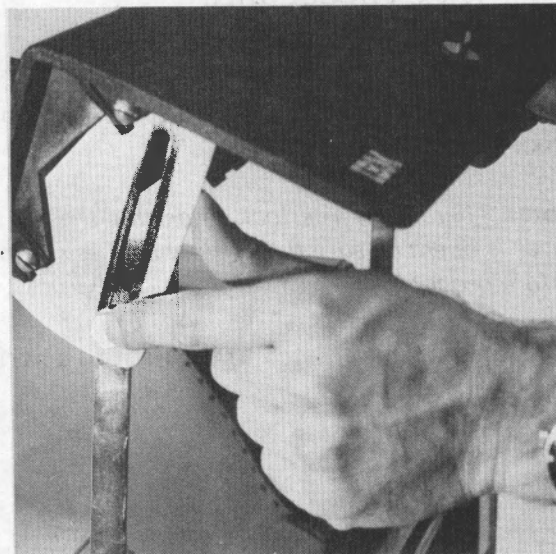
**CAUTION:** The support brackets lock and hold the cover in the open position. You must release the support stops to lower the cover. See "Closing the Cover."



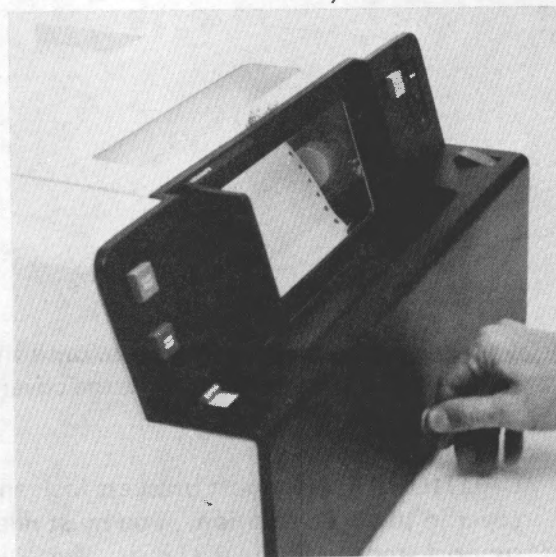
## Closing the Cover

**CAUTION:** The cover latches open. Attempting to close it without releasing the stops will damage the support arms.

1. Squeeze the support arm brackets on both arms at the same time until the brackets slide clear of the stops.
2. Lower the cover to the closed position.



3. Turn the cover latch to the left to the vertical position to lock the cover.



## Inserting Cut Forms

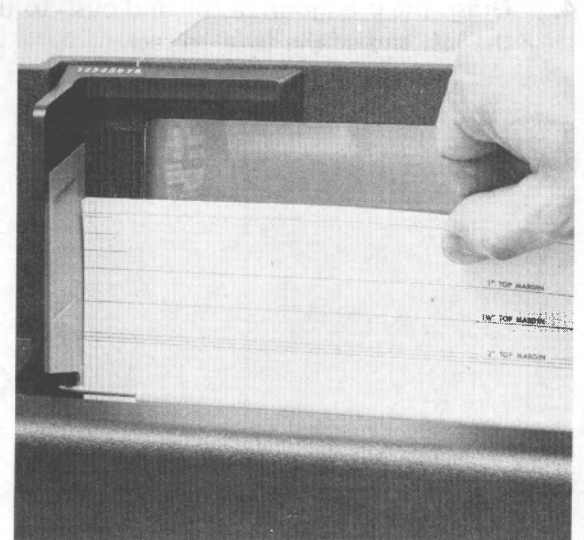
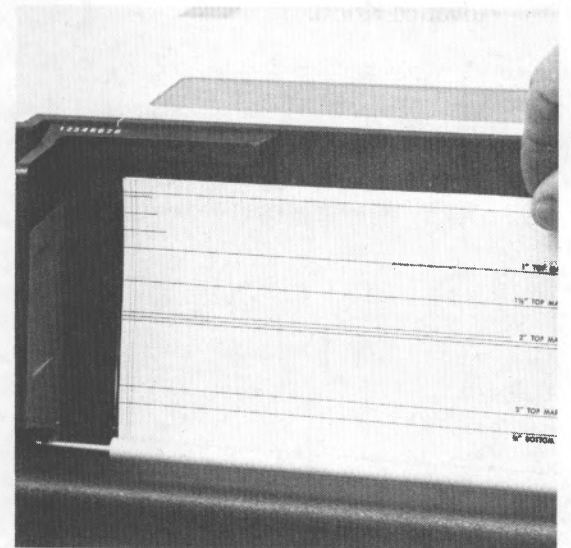
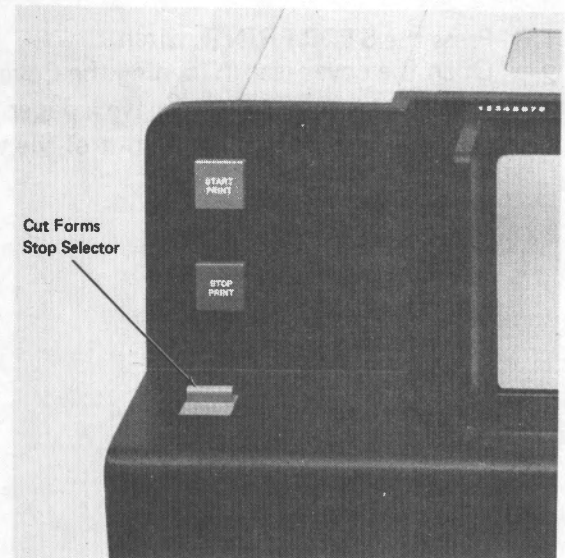
1. Press the STOP PRINT switch.
2. Slide the Cut Forms Stop Selector to the rear position to limit the depth to which cut forms can be inserted. Move it to the forward position to allow full insertion of the cut forms.

**CAUTION:** To avoid damaging the printwheel of the document printing mechanism, do not print off the edge of the document and do not print over or in holes, turned-over edges, folds (including the normal fold), stamps, staples, paper clips, or severely warped pages.

- Remove staples, clips, tape, and other material.
- Flatten folded, damaged, or dog-eared documents.
- Replace torn or severely damaged documents, or manually process them.
- Align the left edge of all documents to the Cut Forms Margin Guide.

3. Insert the cut form into the slot in front of the viewing window.

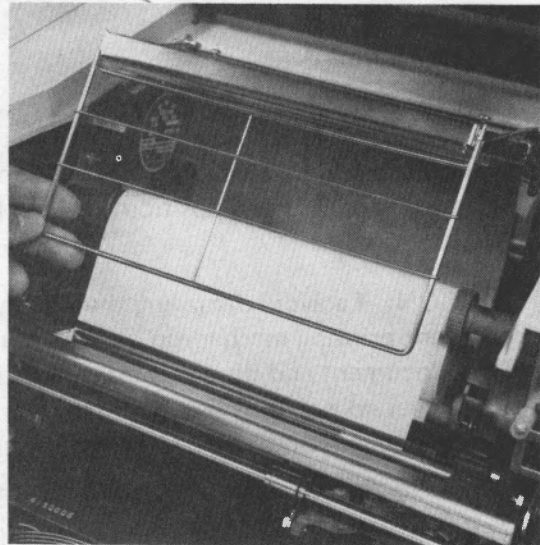
4. Slide the cut form to the left until it is against the Cut Forms Margin Guide, then push it down until it reaches the bottom of the slot or to the desired depth. The small white scribed mark near the bottom of the blue insert on the guide and the red line below the viewing window can be used to position the form for proper printing.
5. Press the START PRINT switch.



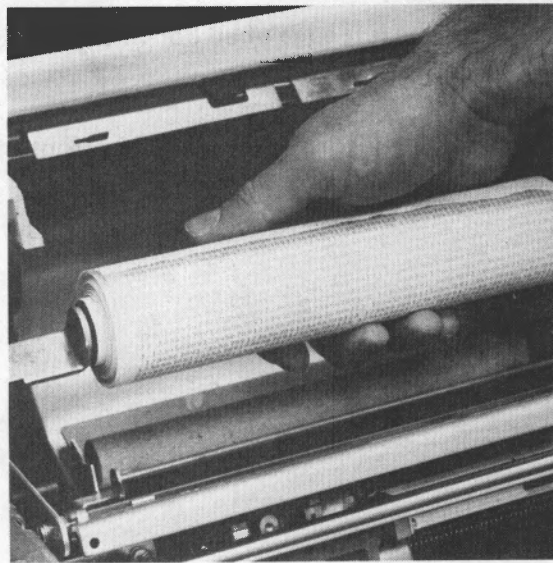


## Journal Roll Removal

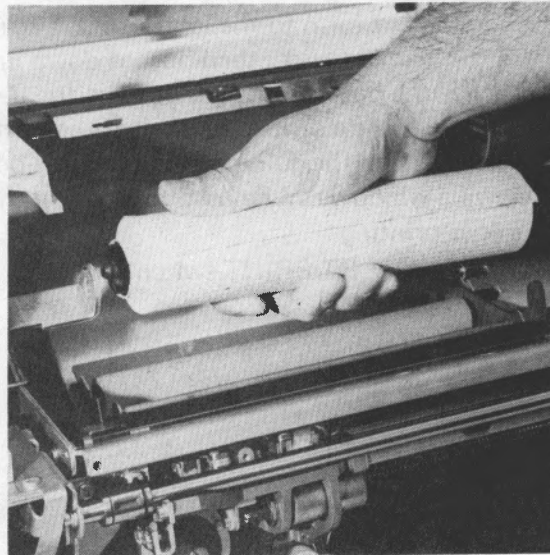
1. Press the STOP PRINT switch.
2. Open the cover (see "Opening the Cover").
- 2a. Some 3610 Model 2 units have a paper guide; carefully raise this guide out of the way.



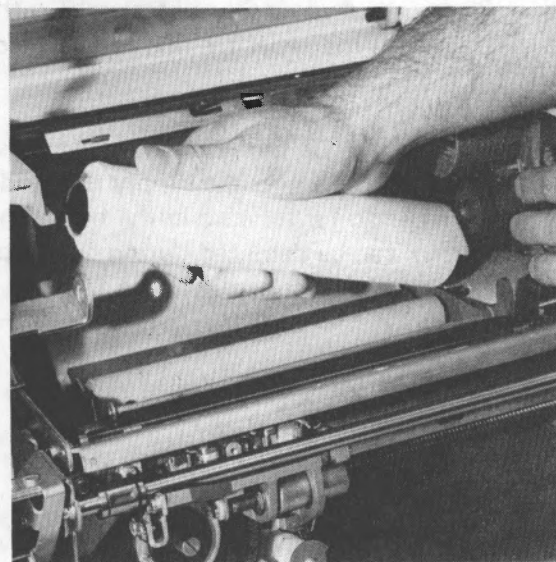
3. Wind the used journal paper onto the take-up reel by turning the roll with your hand or by using the Forms Advance Knob.



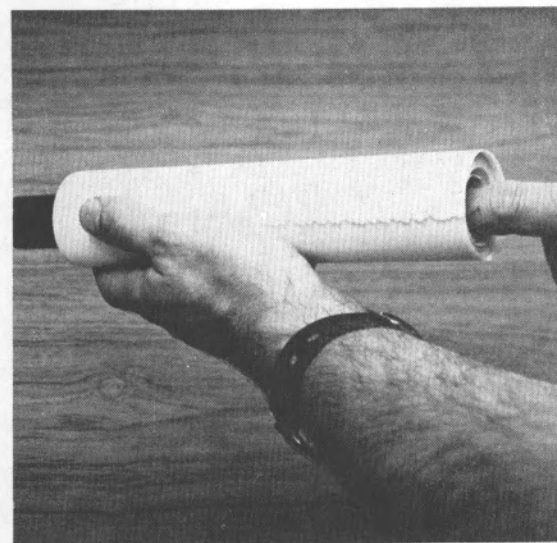
4. Grasp the used journal roll and push to the right to free the left end of the take-up reel.



5. Hold the Forms Advance Knob to the right with your free hand and lift the used journal roll from the machine.
6. If there is unused paper left on the supply roll, cut the used journal roll free.

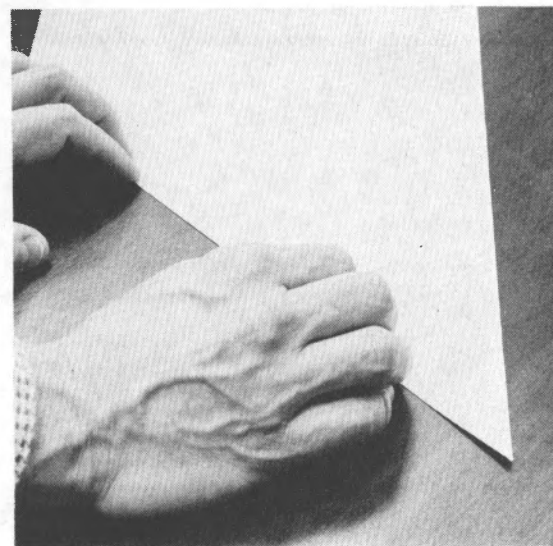


7. Remove the take-up reel by pushing it through the center of the used journal roll with your finger and then pulling it out the other end.



#### **Loading Journal Rolls**

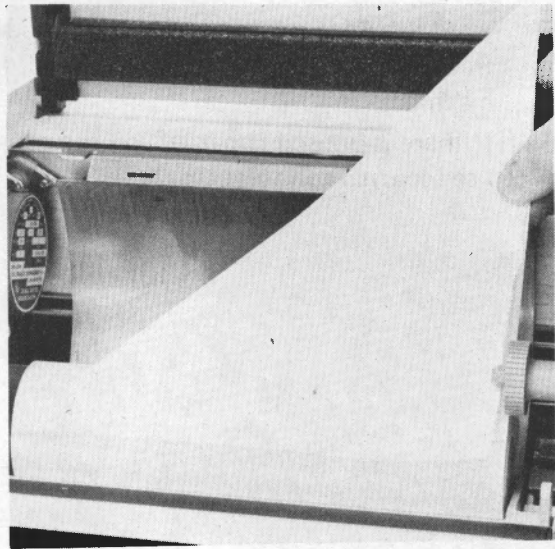
1. Press the STOP PRINT switch.
2. Open the cover. (See "Opening the Cover".)
3. Remove the completed or used portion of the journal roll (see "Journal Roll Removal"), or remove the empty take-up reel and put it aside for the moment.
4. Unroll the new or remaining journal roll that you intend to load into the machine and crease the leading edge to form a point on the right side.



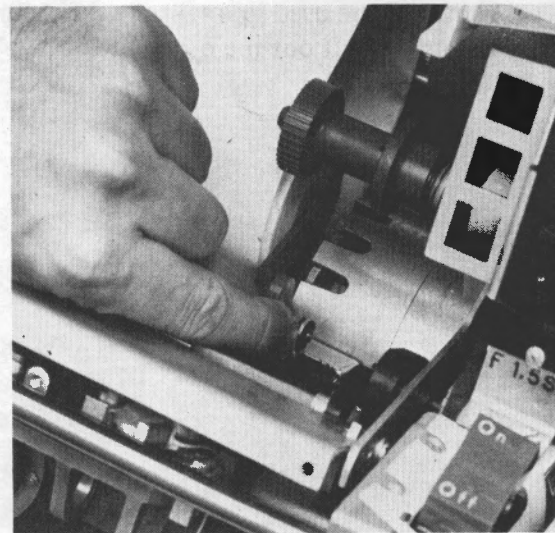


5. Place the new journal roll squarely in the supply roll tray, with the paper feeding forward from the bottom of the roll.

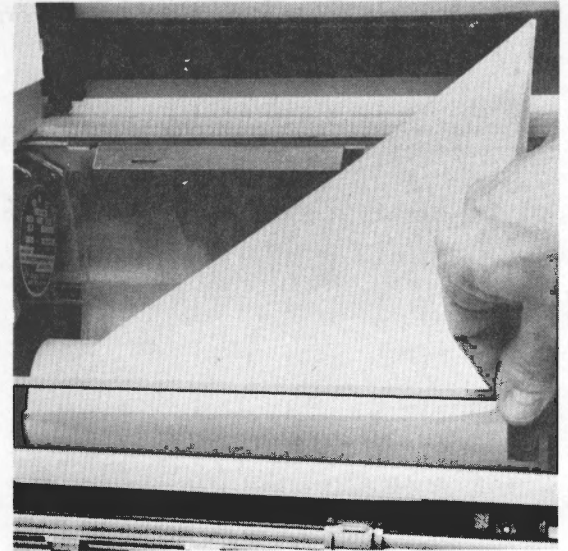
**CAUTION:** Be sure that the new roll is not tilted up on one end over the supply roll guides or too far back or too far forward in the tray. The edges of the journal can be damaged during operation if the roll is not positioned squarely in the tray.



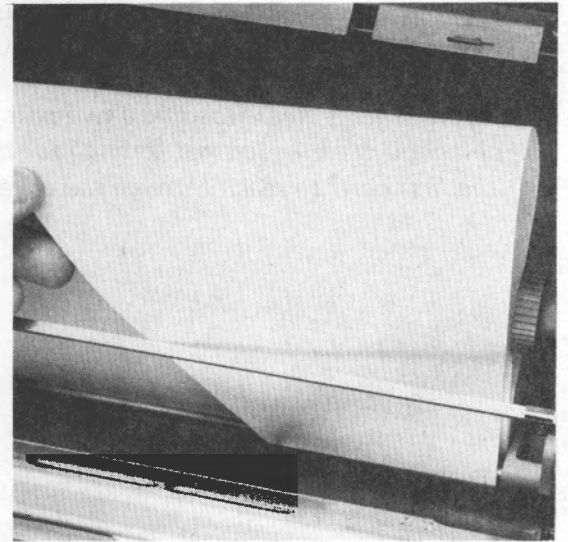
6. Slide the Supply Roll Guide to the left until it touches the end of the journal roll.



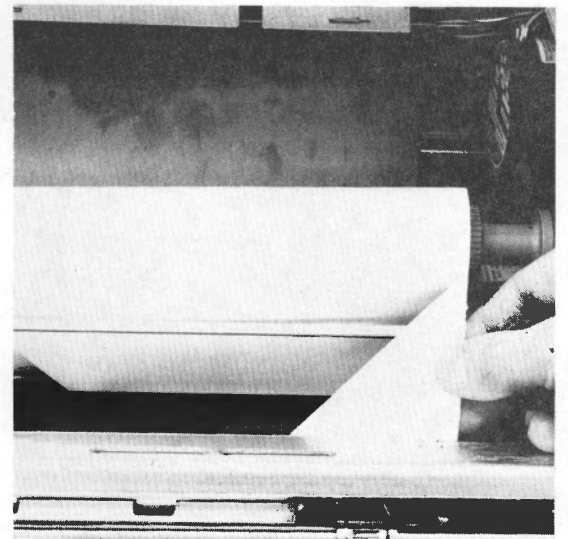
7. Lift the upper Forms Control Rod to its upper stop.



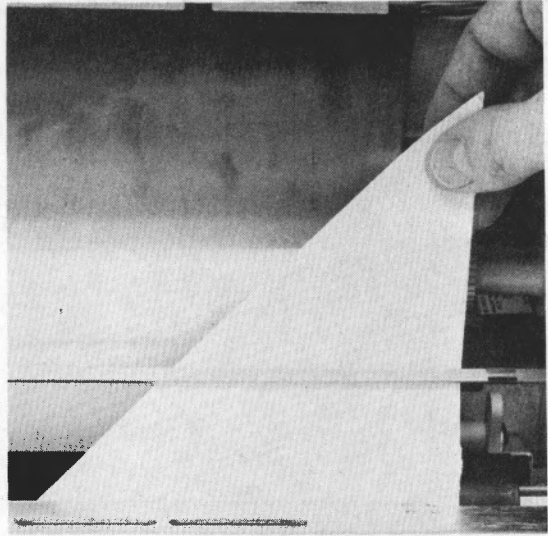
8. Slide the pointed edge of the journal behind the upper Forms Control Rod and down into the space behind the platen, between the platen and the lower Forms Control Rod.



9. Push the journal down until the point comes into view in front of the platen at the right end. Keep the point next to the platen with your finger and continue pushing the journal down until they are completely around the platen and you are able to grasp the point from the top.

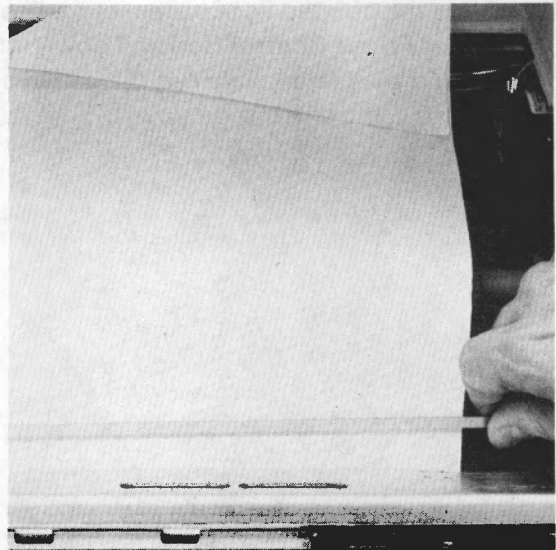


10. Feed the journal between the upper Forms Control Rod and the platen.



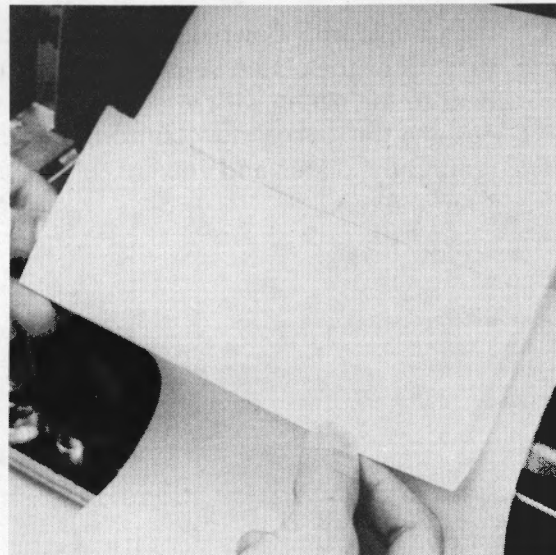
11. Pull the journal through to reach the journal take-up reel and slowly lower the upper Forms Control Rod.

**Note:** *When you are loading a two-part journal roll, pull enough of the journal through for the top sheet (the first part) to reach through the cover.*



12. Unfold the pointed leading edge of the journal and refold it to make a stiff straight edge.

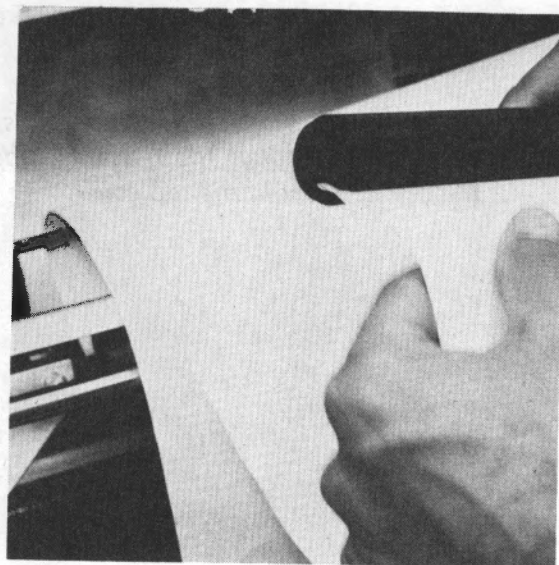
**Note:** *When a two-part journal roll is used, separate the two parts and refold only the part closest to the platen (the second part).*





13. Insert the folded straight edge of the journal into the slot in the take-up reel, aligning the left edge with the step in the take-up reel.

**Note:** *When a two-part journal roll is used, the second part (closest to the platen) is inserted into the take-up reel. The other part (the first part) exits through the slot in the cover.*

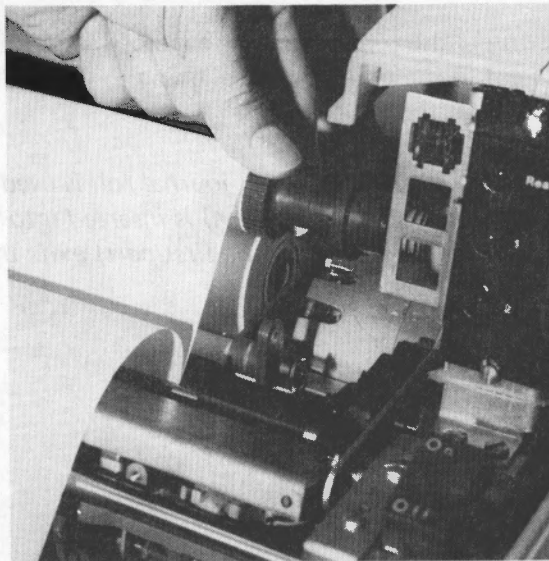


14. Wrap two or three turns of journal paper around the take-up reel.
15. Mount the take-up reel (right end in the spring-loaded Forms Advance Knob and the left end in the hole in the bracket).



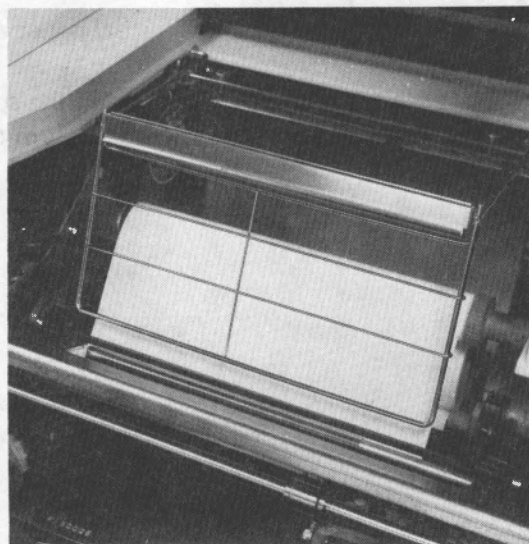
16. Turn the Forms Advance Knob to take up all of the slack.

**Note:** When a two-part journal roll is used, feed the first part up through the viewing window and out the serrated slot in the top cover.



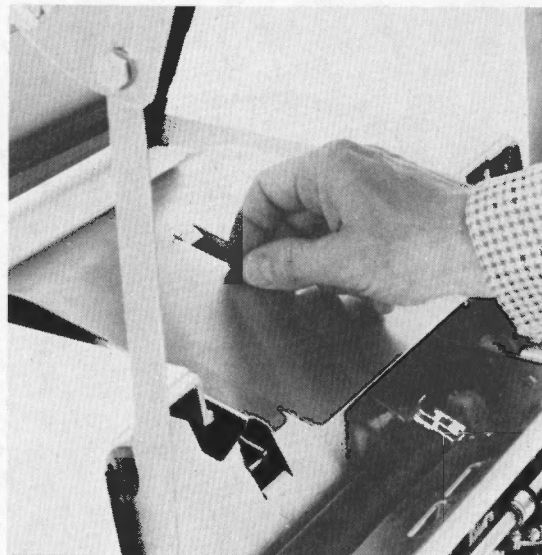
- 16a. If the unit has a paper guide, carefully lower it into place.

17. Release the support arm stops (see "Closing the Cover"), hold the cover with one hand, and grasp the end of the journal paper with the other hand. Close the cover while sliding excess paper out of the top of the cover.

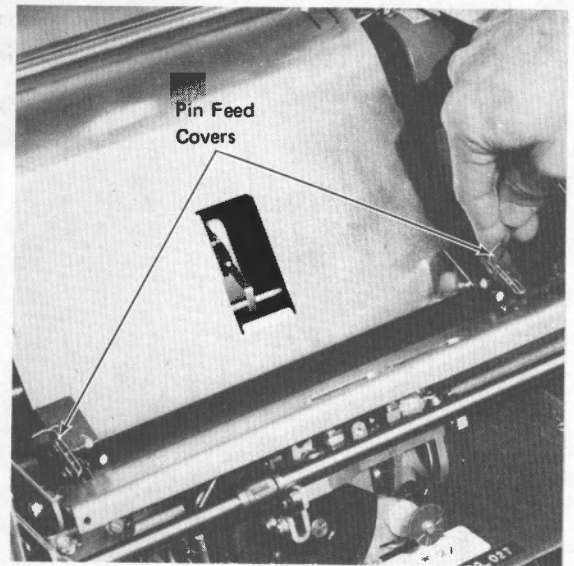


### Loading Continuous Forms

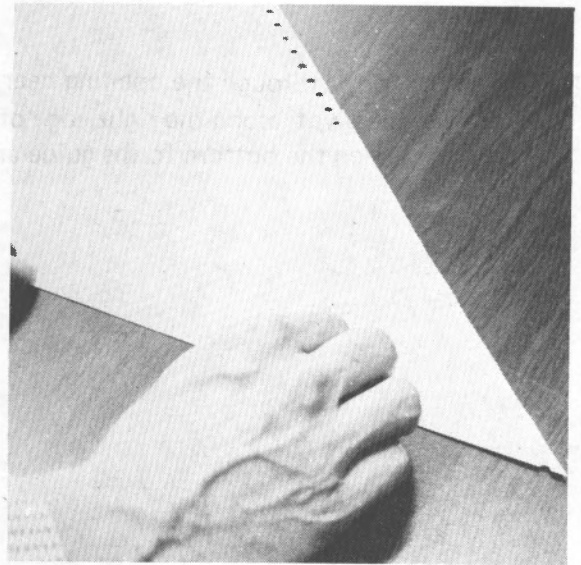
1. Press the STOP PRINT switch.
2. Open the cover (see "Opening the Cover").
3. Lift open the upper forms guide.



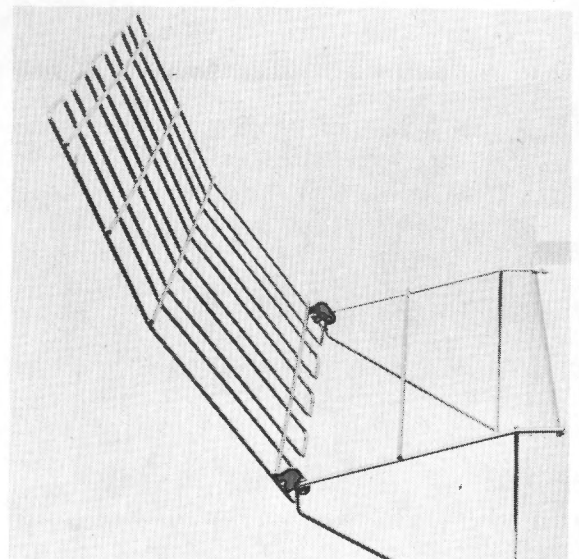
4. Open both pin feed covers by pushing down slightly on the top while pulling them open.



5. Crease the leading edge of the forms to form a point on the right side.

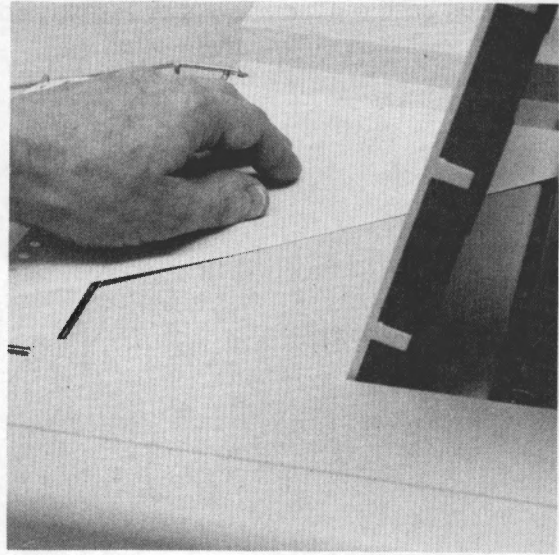


6. Raise the top of the forms rack.

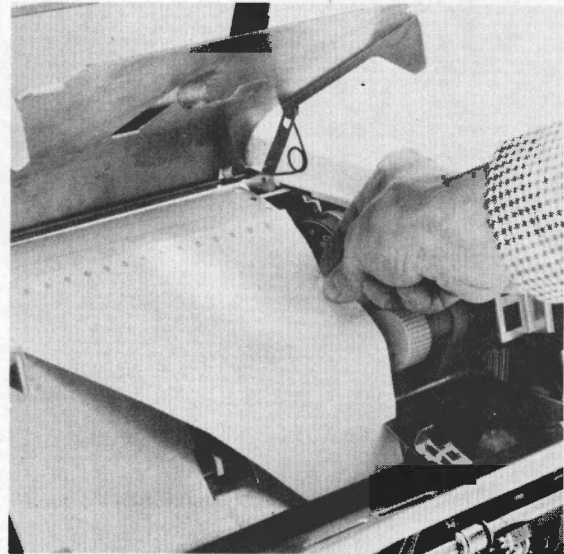




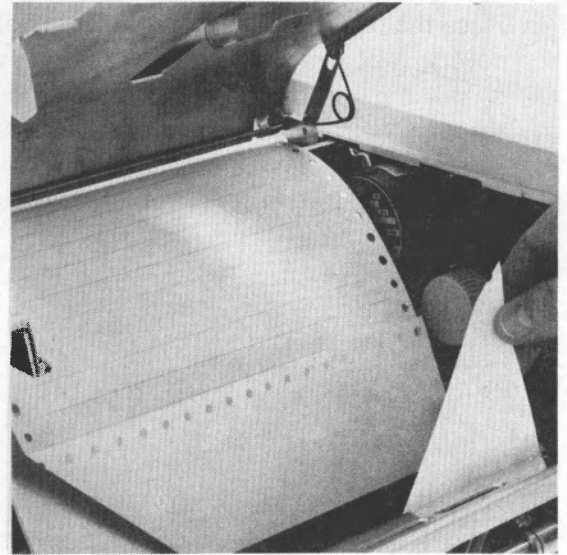
7. Feed the pointed edge of the forms over the guide bar on the forms rack and through the opening in the rear of the top cover.



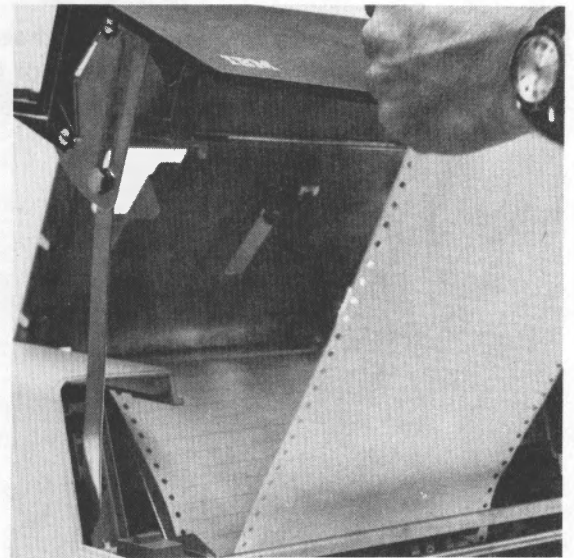
8. Feed the forms through the opening near the upper forms guide pivot, along the right edge of the platen, and down between the bottom forms guide and the platen.



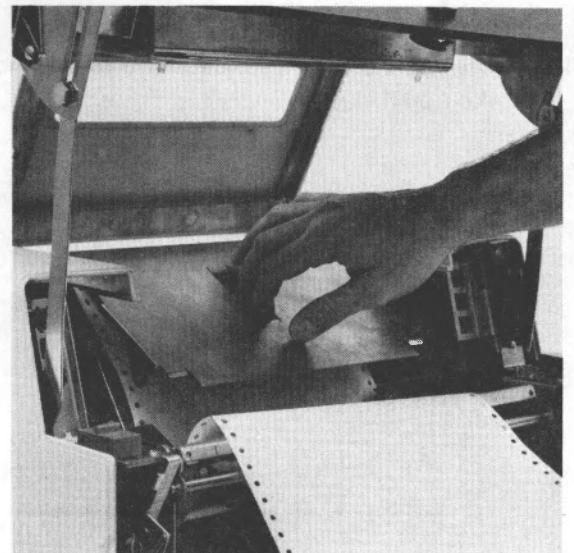
9. Push the forms down until they come into view in front of the platen at the right end. Keep the point next to the platen with your finger and continue pushing the forms down until they are completely around the platen and you are able to grasp the point from the top.



10. Pull the forms through until you have enough to exit *over the bar* in the rear of the top cover.

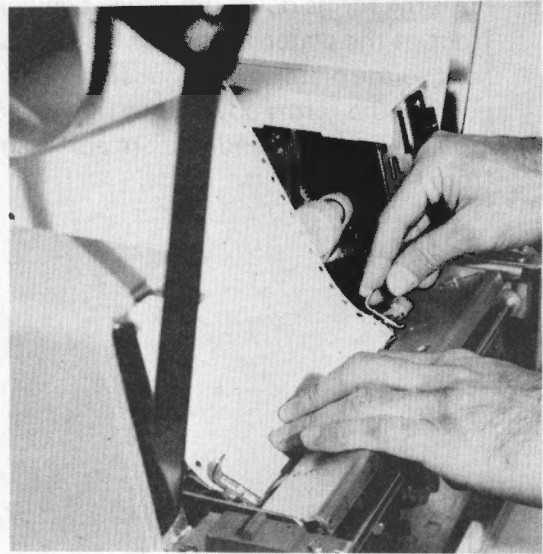


11. Close the upper forms guide.

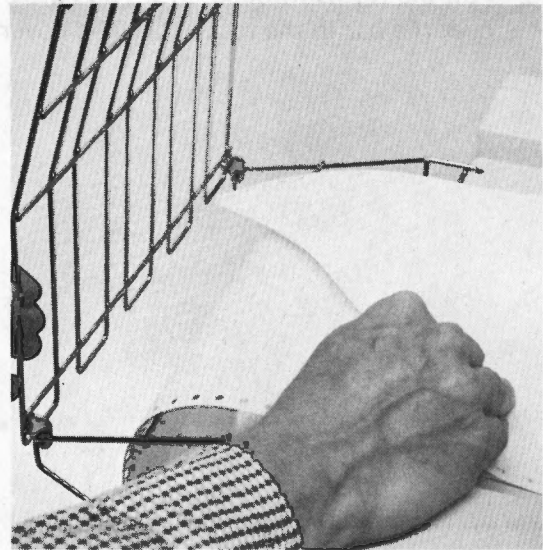




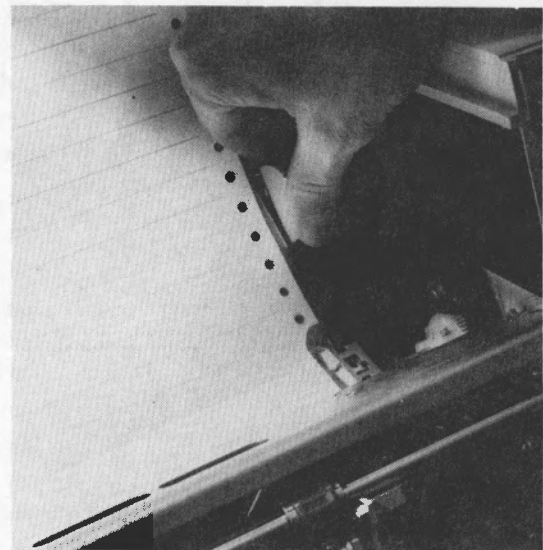
12. Place the forms on the pins and close both pin-feed covers. You can make sure that the forms are straight by making sure that the top pin on each side goes through the same relative hole on both sides of the forms. For example, put the top pin on each side through the third hole from the top on both sides of the form.



13. Feed the forms *over the bar* and out the slot in the back of the top cover. Hold the edge of the forms forward and close the top of the forms rack.

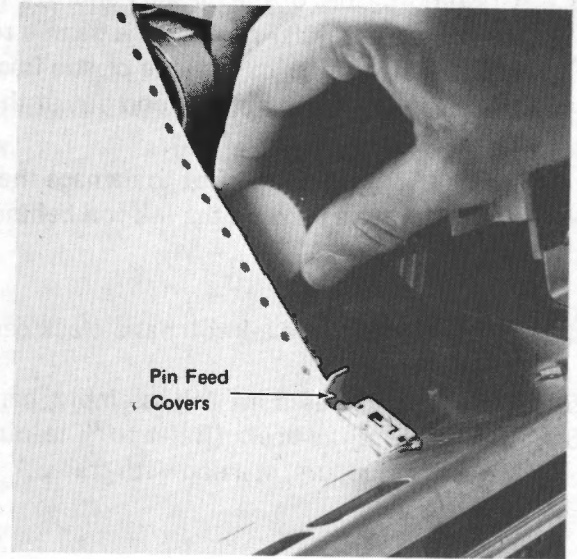


14. Turn the Forms Advance Knob to advance the paper to take up all slack.



15. Position the forms so that the first line printed will print on the correct line on the forms. In most cases, advance the forms until a perforation lines up with the "V" notches in the pin-feed covers. The "V" notches are 1 inch (2.54 cm) above the line to be printed. Using these notches and the perforation as references, you can accurately position the paper for your first print line.

16. Release the support arm stops (see "Closing the Cover"), hold the cover with one hand, and grasp the end of the forms with the other hand. Close the cover while sliding excess paper out the rear of the cover.



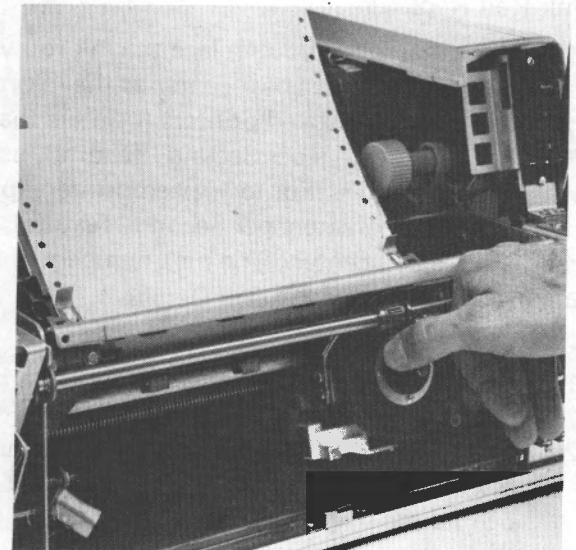
### Ink Roll Removal

Replace the ink roll when printing becomes too light. To avoid getting ink on your fingers when handling ink rolls, be careful not to touch the ink roll itself. Always pick an ink roll up by its plastic handle.

1. Open the cover (see "Opening the Cover").

**CAUTION:** Be sure the printwheel has stopped turning before proceeding.

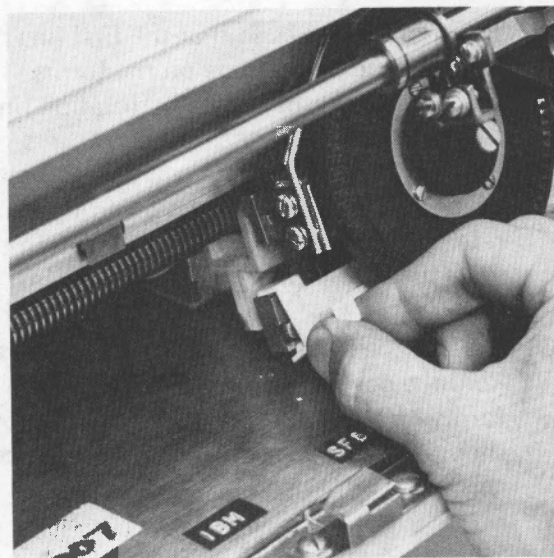
2. Push the print unit all the way to the right.



3. Grasp both sides of the plastic handle of the ink roll assembly. Carefully push on the handle towards the back of the printer to free one plastic finger. Then lift the ink roll assembly up and out of the printer.

**CAUTION:** Be careful not to damage the print wheel. Do not pull up hard on the ink roll behind the print wheel.

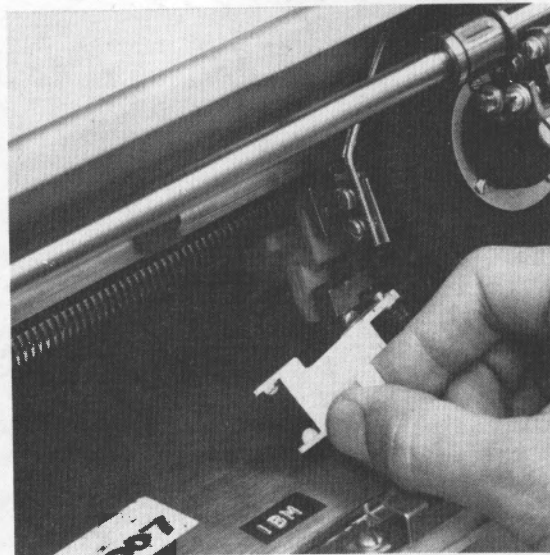
4. Check whether the ink roll has a black center or a white center.
5. Dispose of the used ink roll assembly, handle and all.
6. Clean the print wheel. (Refer to "Cleaning the Print Wheel" procedure, starting with step 3.)



### Ink Roll Replacement

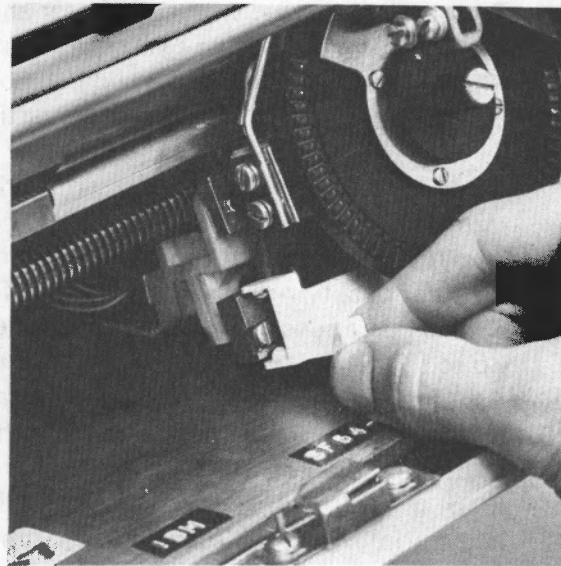
Make sure that when you replace the ink roll you install one that has the same color center as the ink roll you removed. For high-speed printers (printers that have the "Up to 30 Characters per Second" feature), use an ink roll with a white center. For low-speed printers (printers that have the "15 Characters per Second" feature), use an ink roll with a black center. The part numbers of the ink rolls are listed under "Installation Details."

1. Remove the new ink roll assembly from its protective package.
2. Grasp the plastic handle and guide the ink roll assembly down and to the right until the ink roll is behind the print wheel.





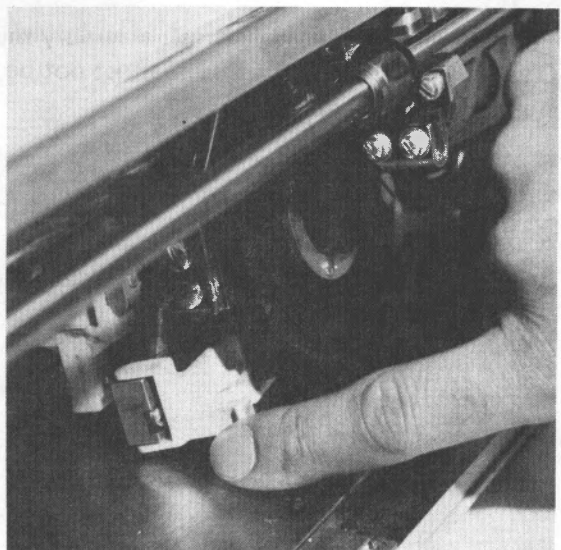
3. Place the plastic fingers directly over their notches on the mounting block.



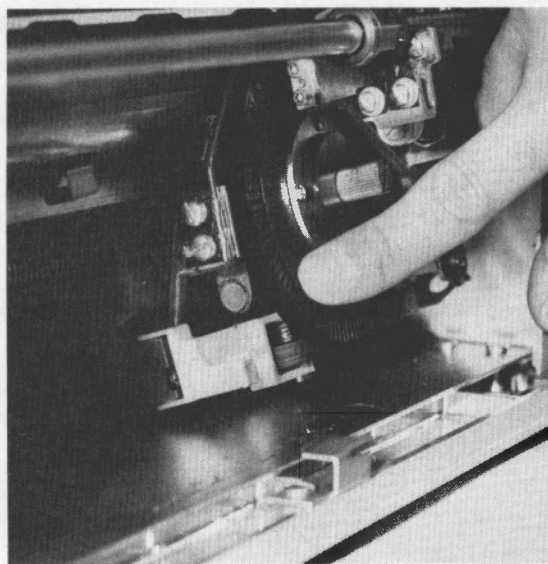
4. Push the ink roll handle down until the fingers snap onto the mounting block.



5. Push the handle of the ink roll assembly to the right, against the spring tension, several times (to test that the ink roll assembly is properly seated).



6. Turn the print wheel with your finger and make sure that the ink roll is rolling against the rear of the print wheel. If the ink roll is not rolling, remove the ink roll assembly and repeat this procedure starting from step 2.
7. After installing the new ink roll, print briefly on a test form to make sure that the ink roll has been correctly installed, that the print wheel is fairly clean, and that the print quality reaches a good level before restarting normal operations. To print, do the following steps.
  8. Go to a 3604 and log on as the control operator.
  9. Assign the printer using the 007 command.
  10. Key in the 020 command and instruct the exerciser to run for a number of lines.
  11. Insert a test form and press the START PRINT switch.
  12. If the printer is a high-speed printer (it has the "Up to 30 Characters per Second" feature), the ink roll package has a print wheel wiper assembly. Put on this new print wheel wiper assembly. (See "Print Wheel Wiper Removal and Replacement Procedures.")



### **Cleaning the Print Wheel**

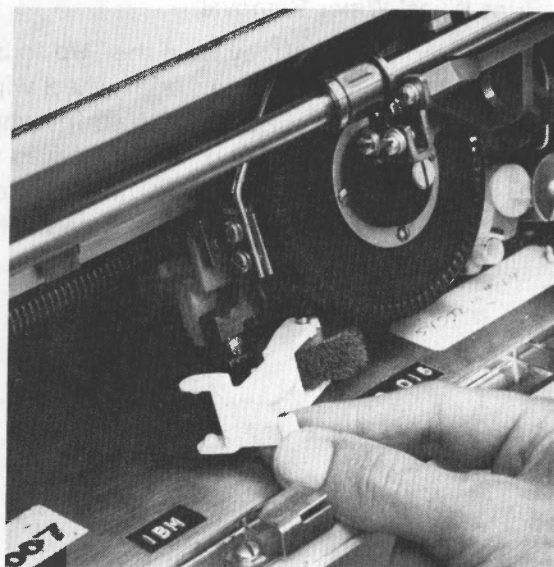
Clean the typeface on the print wheel when characters are not printing clearly or whenever you replace the ink roll.

To clean the print wheel, use the cleaning brush assembly (PN 1811470). It fits on the ink roll mounting block and is installed and removed in the same way as the ink roll assembly. Therefore, to install and remove the cleaning brush assembly, use the "Ink Roll Removal" and "Ink Roll Replacement" procedures.

**CAUTION:** The cleaning brush assembly must be used dry. Cleaning fluid, solvent, or paste must not be applied to the cleaning brush at any time.

1. Open the cover. (See "Opening the Cover.")
2. Remove the ink roll assembly. (See "Ink Roll Removal.")
3. Remove the cleaning brush assembly from its protective package.

4. Install the cleaning brush assembly. (See "Ink Roll Replacement".) If the cleaning brush is not rolling after installation, remove it using the "Ink Roll Removal" procedure and repeat installation.
5. Close the cover. (See "Closing the Cover.")
6. Go to a 3604 and log on as the control operator.
7. Assign the printer using the 007 command.
8. Verify that there is paper in the printer; then key in the 066 command.
9. Press the START PRINT switch if printing does not begin. (Printing will stop after 20 lines or when the end of the form is reached, whichever comes first, or if an error occurs.)
10. When printing stops, open the cover, remove the cleaning brush assembly (see "Ink Roll Removal"), close the cover, and key in the 066 command.
11. Return the cleaning brush assembly to its protective package and store it in a convenient place for future use.
12. When printing stops, open the cover, install the ink roll assembly (see "Ink Roll Replacement"), and close the cover.
13. Check the printed characters. If any character is not printing fully and clearly, repeat this print wheel cleaning procedure from the beginning.
14. If the printing appears light, repeat steps 8 and 9 until the printing is acceptable.

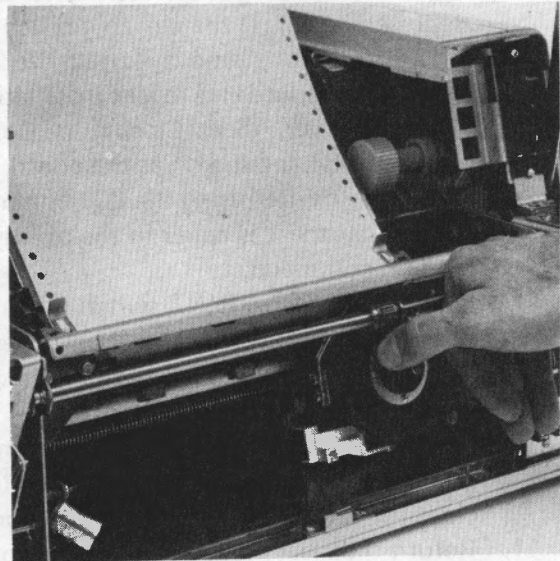




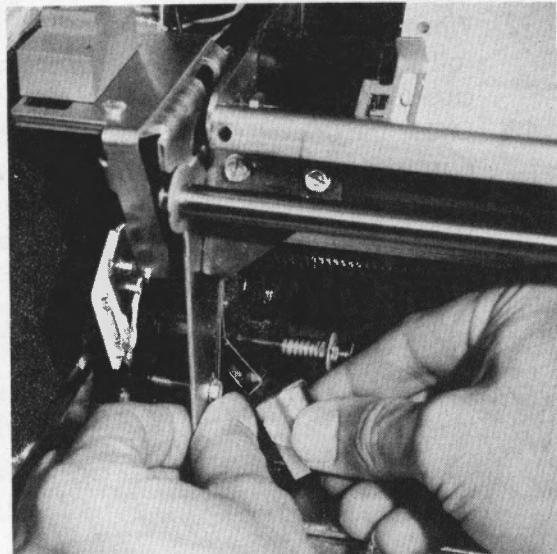
### Print Wheel Wiper Removal

High-speed printers (they have the "Up to 30 Characters per Second" feature) have a felt print wheel wiper to wipe excessive ink from the edge of the print wheel. It must be replaced when it gets full of ink or clogged with paper dust.

1. Open the cover. (See "Opening the Cover".)
2. Push the print unit all the way to the right.

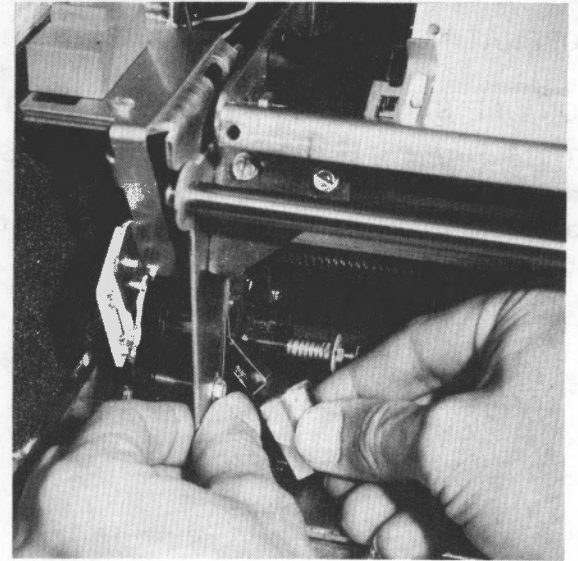


3. With your left hand, hold the spring bracket. With your right, pull the wiper holder until it snaps loose from the spring bracket.
4. Dispose of the old wiper assembly.



### Print Wheel Wiper Replacement

1. Remove the new wiper assembly from its protective package.
2. Place your left thumb behind the plastic mounting block to hold the spring bracket and to provide support for the mounting block. Hold the wiper with your right hand so that the holes in the felt wiper assembly are at the front, and push the felt wiper assembly up from the bottom until it snaps into place on the plastic mounting block.



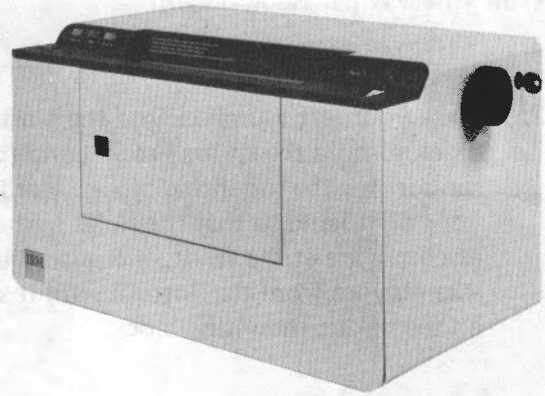


## MODELS 4 AND 5

### OPERATING CONTROLS AND LIGHTS

#### ON/OFF, START, STOP Switches and READY, 1, 2 Lights

The operation of the ON/OFF, START, and STOP switches and the meaning of the READY, 1, and 2 lights is the same as for the Models 1, 2, and 3 described in the beginning of this subsection.

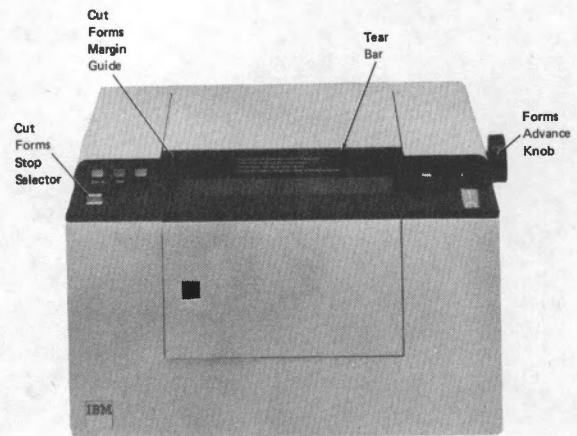


#### Cut Forms Stop Selector

The Cut Forms Stop Selector is a two-position slide switch. When the slide switch is in the rear position, the depth that cut forms can be inserted into the printer is limited. In the forward position, the depth of insertion of cut forms is not limited.

#### Forms Advance Knob

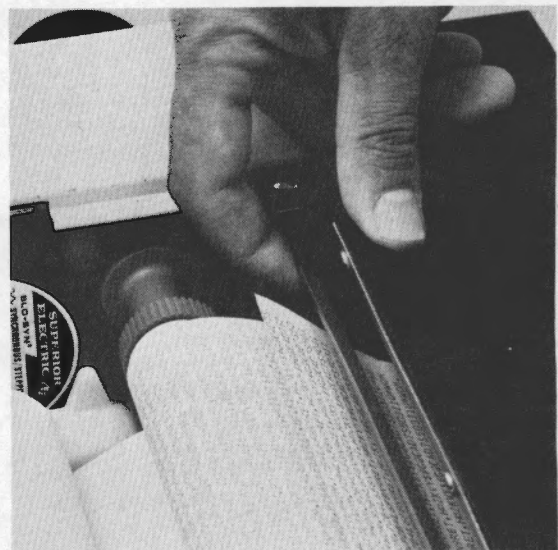
Turn this knob to move the journal take-up roll forward in small increments. (If only single-part journal paper is being fed out of the unit through the cover, this knob will not advance the paper; pull the paper upwards from the unit to advance it.)



#### Forms Control Rod

The Forms Control Rod is actually two rods that move together: an upper control rod in front of the platen (this rod can be seen in the photograph) and a lower control rod in back of the platen. When you raise or lower the upper control rod, you also raise or lower the lower control rod.

When you want to load, unload, or straighten the journal, you must raise the upper control rod to its upper stop. In that position, the pressure rolls that hold the paper against the platen are out of the way, and the forms path through the printer is open. Paper already in the machine is then loose and can be removed or realigned, or a new journal can be loaded.

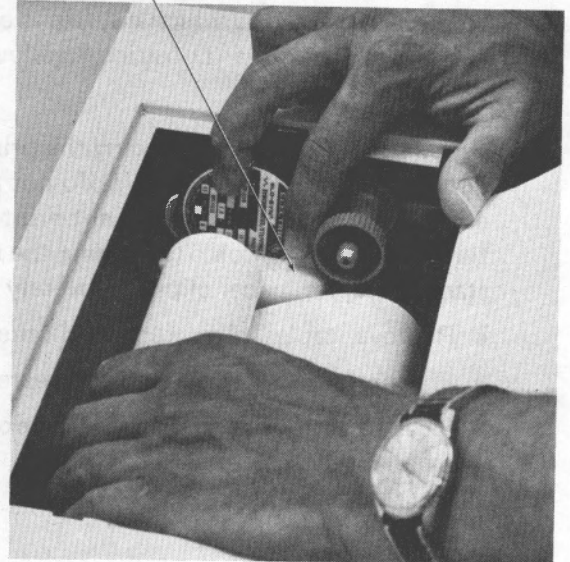


**CAUTION:** Be careful when lowering the upper control rod after you have loaded the journal. The control rod can snap the paper tightly against the platen. The journal is pressure-sensitive and could be marked.

### Supply Roll Guide

The Supply Roll Guide slides against the right end of journal rolls and keeps them squarely in the supply roll tray.

Supply  
Roll  
Guide



### CLEANING PROCEDURES

To clean the covers, use warm water and a mild detergent.

### OPERATING PROCEDURES

#### Opening and Closing the Covers

The top cover is removed by first unlocking the cover with the lock on the side and then lifting the right edge of the cover.

The front cover is removed by moving the latch tab to the right and pulling out the left edge of the cover.

**CAUTION:** Be sure the print wheel has stopped turning before proceeding.

The covers are closed using the reverse of the opening procedures.

## Inserting Cut Forms

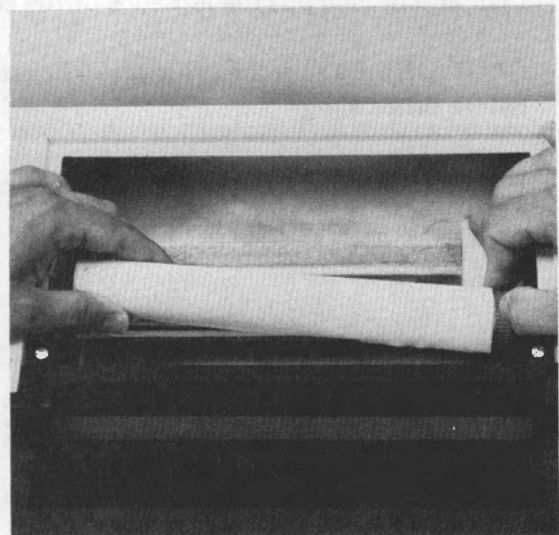
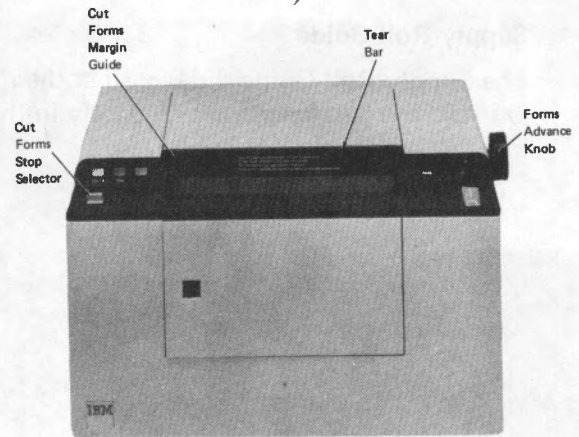
1. Press the STOP print switch.
2. Slide the Cut Forms Stop Selector to the rear position to limit the depth to which cut forms can be inserted. Move it to the forward position to allow full insertion of the cut forms.

**CAUTION:** To avoid damaging the print wheel of the document printing mechanism, do not print off the edge of the document and do not print over or in holes, turned-over edges, folds (including the normal fold), stamps, staples, paper clips, or severely warped pages.

- Remove staples, clips, tape, and other material.
  - Flatten folded, damaged, or dog-eared documents.
  - Replace torn or severely damaged documents, or manually process them.
  - Align the left edge of all documents to the Cut Forms Margin Guide.
3. Insert the cut form into the slot in front of the paper tear bar.
  4. Slide the cut form to the left until it is against the Cut Forms Margin Guide, and then push it down until it reaches the bottom of the slot or to the desired depth.
  5. Press the appropriate START print switch.

## Journal Roll Removal

1. Press the STOP print switch.
2. Open the top cover. (See "Opening and Closing the Covers.")
3. Wind the used journal paper onto the take-up reel by turning the Forms Advance Knob.
4. Grasp the used journal roll and push to the right to free the left end of the take-up reel.
5. Hold the knob at the right end of the roll to the right and lift the used journal roll from the printer.
6. If there is unused paper left on the supply roll, cut the used journal roll free by holding the paper against the tear bar and tearing off the used journal roll.
7. Remove the take-up reel by pushing it through the center of the used journal roll with your finger and then pulling it out the other end.



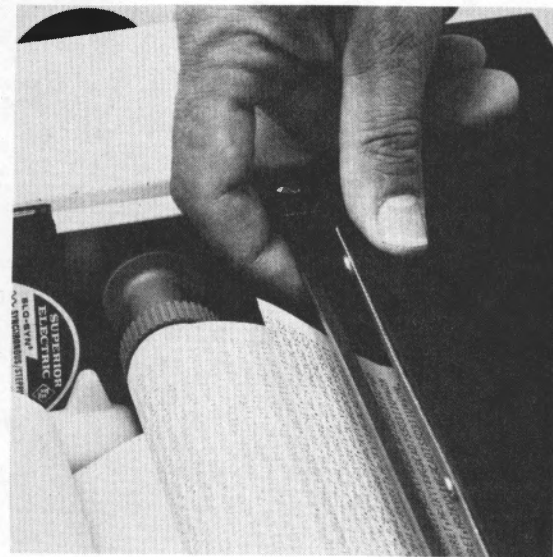


### Loading Journal Rolls

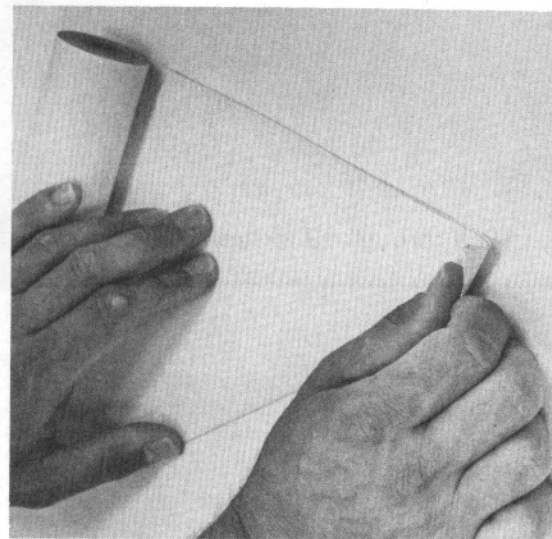
1. Press the STOP print switch.
2. Open both covers. (See "Opening and Closing the Covers.")

**CAUTION:** Be sure the print wheel has stopped turning before proceeding.

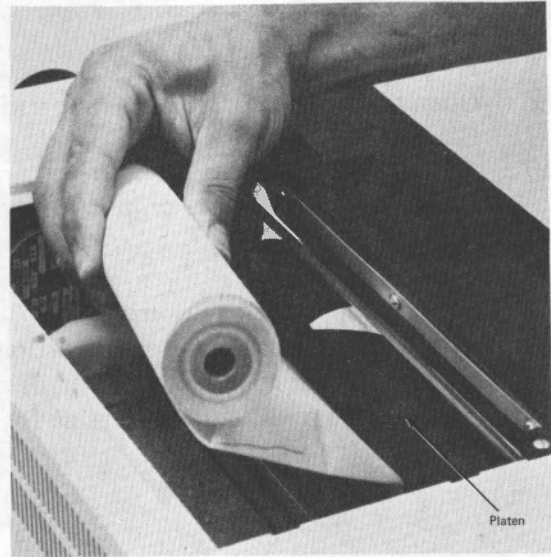
3. Lift the upper Forms Control Rod.
4. Remove the completed or used portion of the journal roll (see "Journal Roll Removal"), or remove the empty take-up reel and put it aside for the moment.



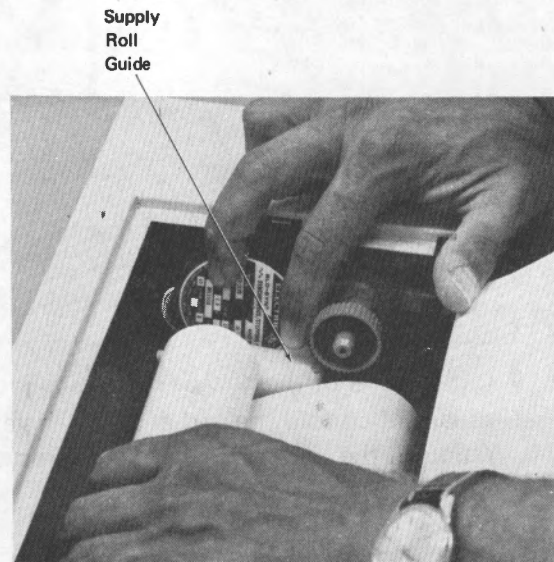
5. Cut the end of the new or remaining journal roll square, then fold the end at a 45° angle to form a point on the right side; slightly curl up the point.



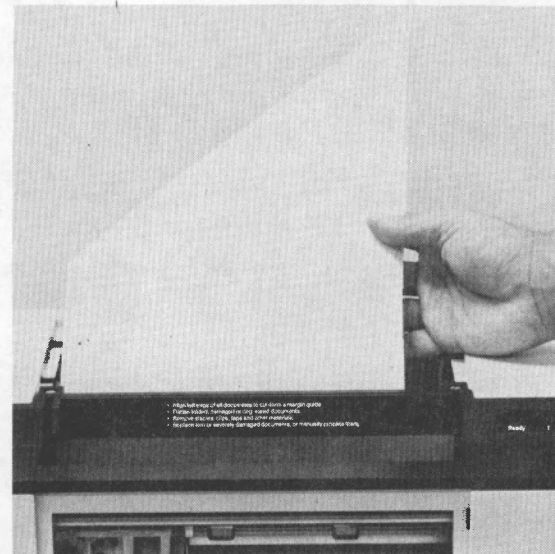
6. Insert the point between the lower Forms Control Rod and the platen, and move the paper back and forth, feeding through until the point appears at the top of platen. (The point may be guided from front access cover.)
7. Guide the paper between the platen and upper Forms Control Rod.



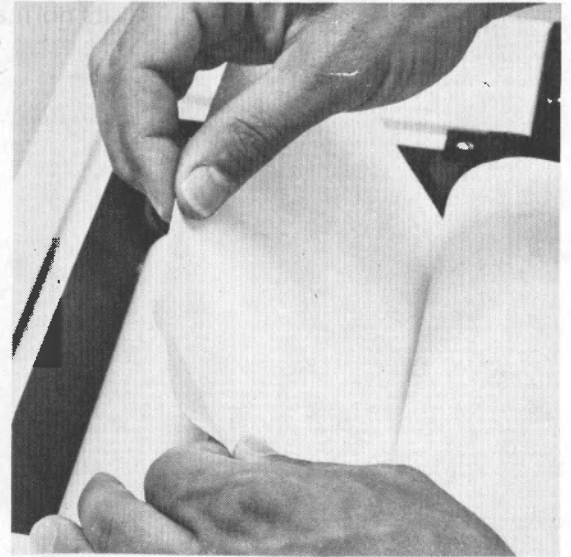
8. Push the Supply Roll Guide to the right, place the journal roll squarely in the supply roll tray, and then release the guide.



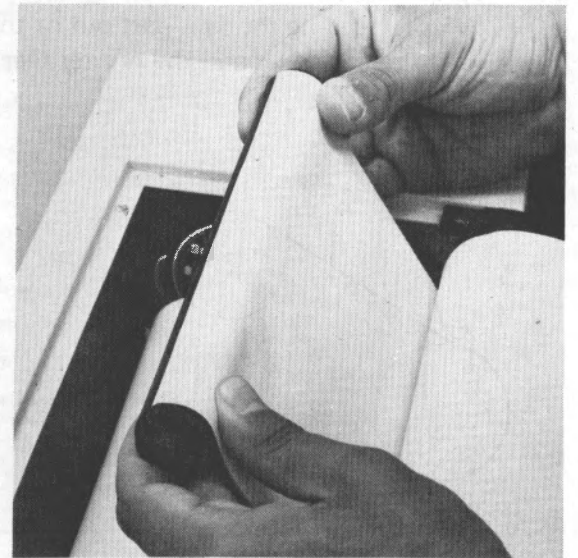
9. Pull through 12 inches (30.5 cm) of paper.



10. Separate the paper if it is a two-part journal roll and fold the second part to a square end. If it is a single-part journal roll that is to be taken up in the printer, fold it as for the second part. If it is a single-part journal roll that is to be fed out of the unit, skip this step and step 11.



11. Insert the end into the slot in the take-up reel and roll around and over the top of the reel. (The left end of the take-up reel has a large centering bump on it.)

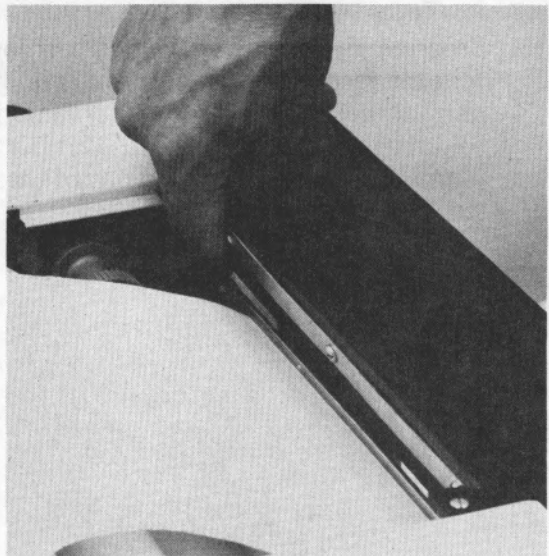


12. Replace the take-up reel by pushing the knob to the right with the right end of the reel against it and lower the left end of the reel into place. Take up the slack in the paper by turning the Forms Advance Knob.

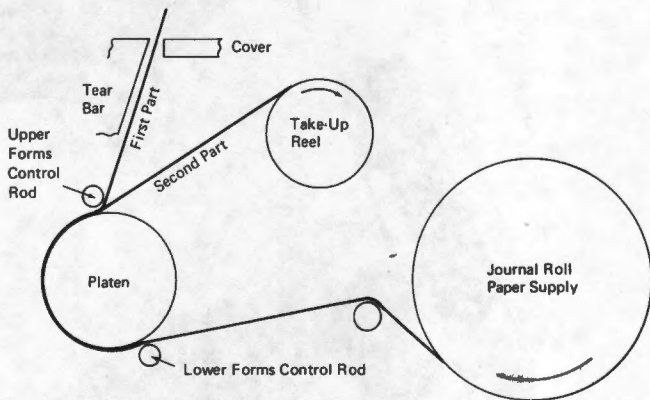
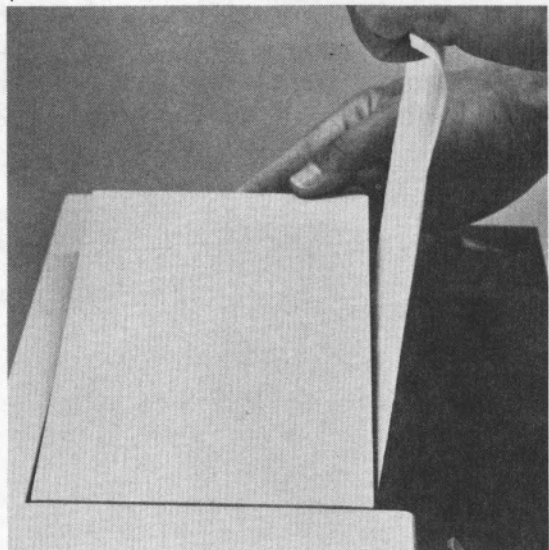




13. Slowly lower, towards the front of the printer, the upper Forms Control Rod into its normal position.



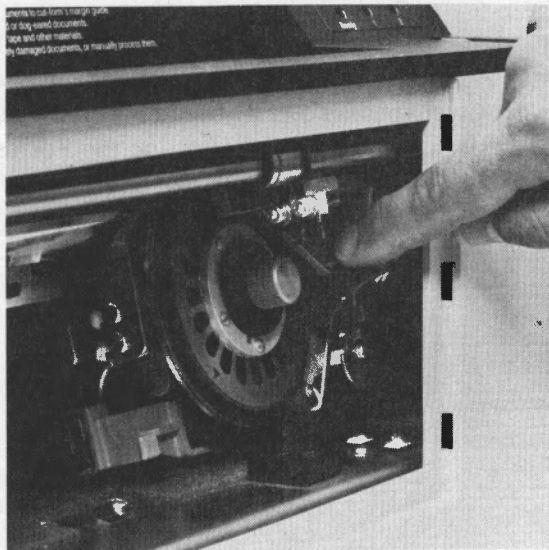
14. Replace the covers (see "Opening and Closing the Covers"), feeding the first part out of the printer between the top cover and the printer tear bar.



### Ink Roll Removal

Replace the ink roll when the printing becomes too light. To avoid getting ink on your fingers when handling ink rolls, be careful not to touch the ink roll itself. Always pick an ink roll up by its plastic handle.

1. Open the front cover (see "Opening and Closing the Covers").
2. Push the print unit all the way to the right.





3. Grasp both sides of the plastic handle of the ink roll assembly. Carefully pull on the handle to free the lower plastic finger. Then lift the ink roll assembly up and out of the printer.

**CAUTION:** Be careful to not damage the print wheel. Do not pull up hard on the ink roll behind the print wheel.

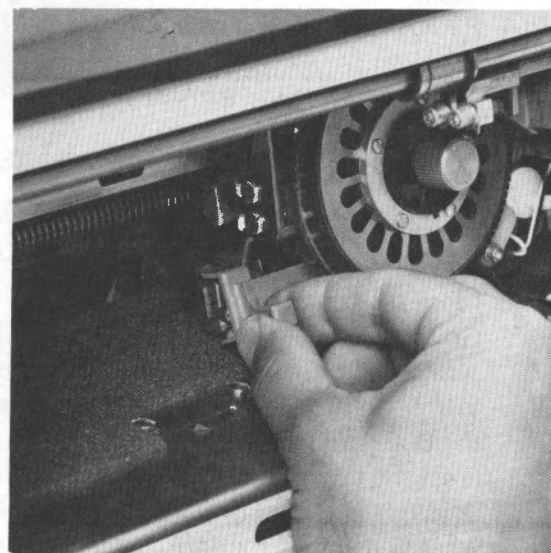
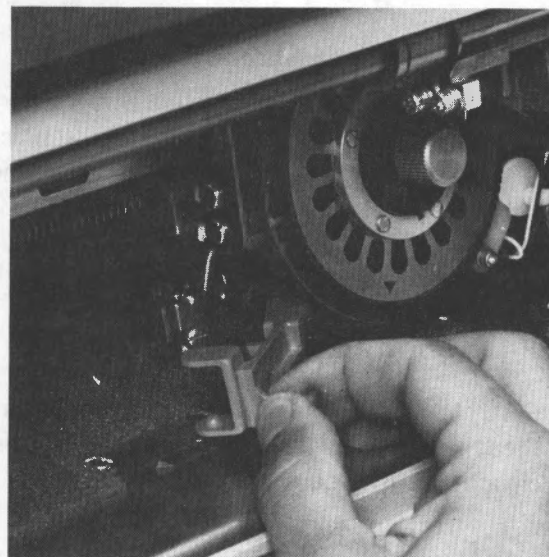
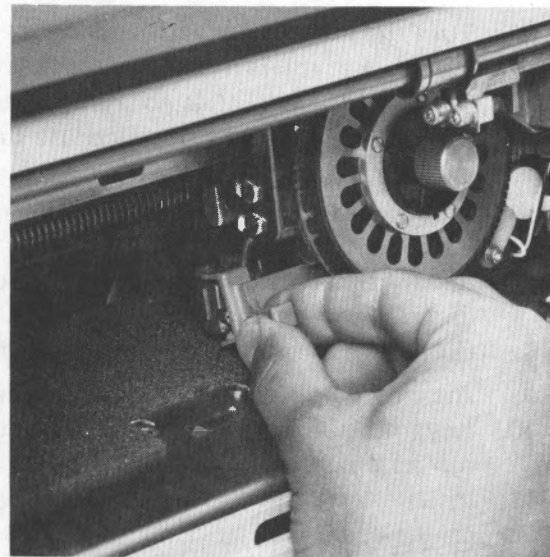
4. Dispose of the used ink roll assembly, handle and all.
5. Clean the print wheel. (Refer to "Cleaning the Print Wheel" procedure, starting with step 3.)

### Ink Roll Replacement

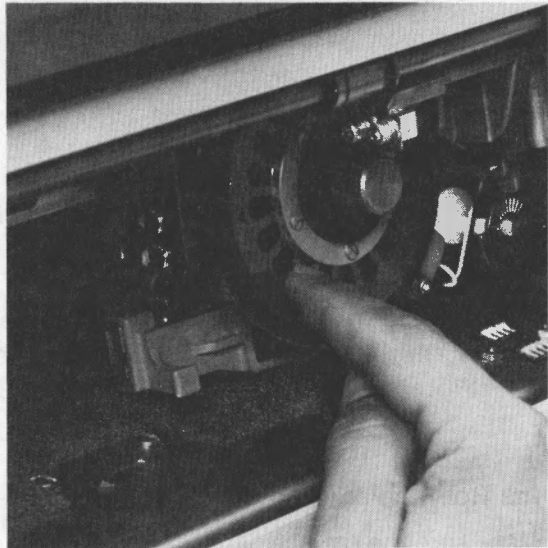
Make sure the replacement ink roll is IBM part number 432860.

1. Remove the new ink roll assembly from its protective package.
2. Grasp the plastic handle and guide the ink roll assembly down and to the right until the ink roll is behind the print wheel.

3. Place the upper plastic finger directly on its notch on the mounting block.
4. Push the ink roll handle down until the lower finger snaps onto the mounting block.
5. Push the handle of the ink roll assembly to the right, against the spring tension, several times (to test that the ink roll assembly is properly seated).



6. Turn the print wheel with your finger and make sure that the ink roll is rolling against the rear of the print wheel. If the ink roll is not rolling, remove the ink roll assembly and repeat this procedure starting from step 2.
7. After installing the new ink roll, print briefly on a test form to make sure that the ink roll has been correctly installed, that the print wheel is fairly clean, and that the print quality reaches a good level before restarting normal operations. To print, do the following steps.
8. Go to a 3604 and log on as the control operator.
9. Assign the printer using the 007 command.
10. Key in the 020 command and instruct the exerciser to run for a number of lines.
11. Insert a test form and press the appropriate START print switch.
12. Replace the print wheel wiper assembly. (See "Print Wheel Wiper Removal and Replacement Procedures.")



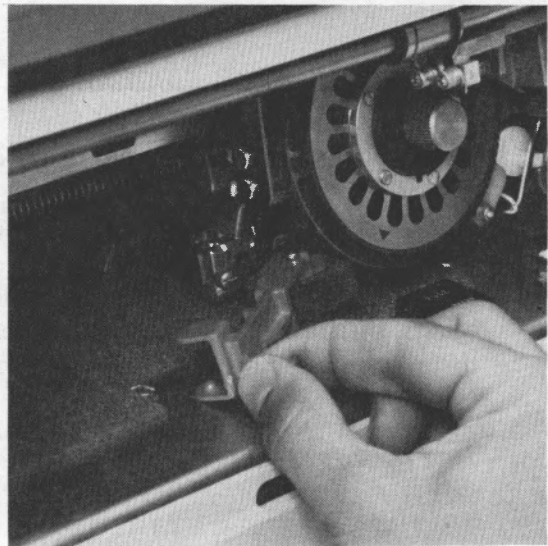
### Cleaning the Print Wheel

Clean the typeface on the print wheel when characters are not printing clearly or whenever you replace the ink roll.

To clean the print wheel, use the cleaning brush assembly (PN 1811470). It fits on the ink roll mounting block and is installed and removed in the same way as the ink roll assembly. Therefore, to install and remove the cleaning brush assembly, use the "Ink Roll Removal" and "Ink Roll Replacement" procedures.

**CAUTION:** The cleaning brush assembly must be used dry. Cleaning fluid, solvent, or paste must not be applied to the cleaning brush at any time.

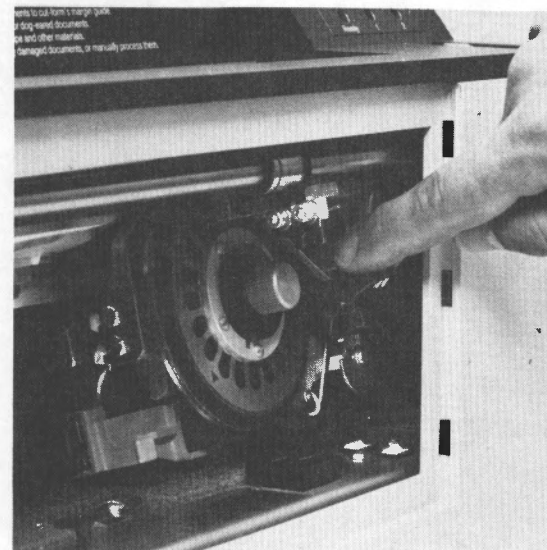
1. Open the front cover. (See "Opening and Closing the Covers.")
2. Remove the ink roll assembly. (See "Ink Roll Removal.")
3. Remove the cleaning brush assembly from its protective package.
4. Install the cleaning brush assembly. (See "Ink Roll Replacement".) If the cleaning brush is not rolling after installation, remove it using the "Ink Roll Removal" procedure and repeat step 4.
5. Close the cover.
6. Go to a 3604 and log on as the control operator.
7. Assign the printer using the 007 command.
8. Verify that there is paper in the printer; then key in the 066 command.
9. Press the appropriate START print switch if printing does not begin. (Printing will stop after 20 lines or when the end of the form is reached, whichever comes first, or if an error occurs.)



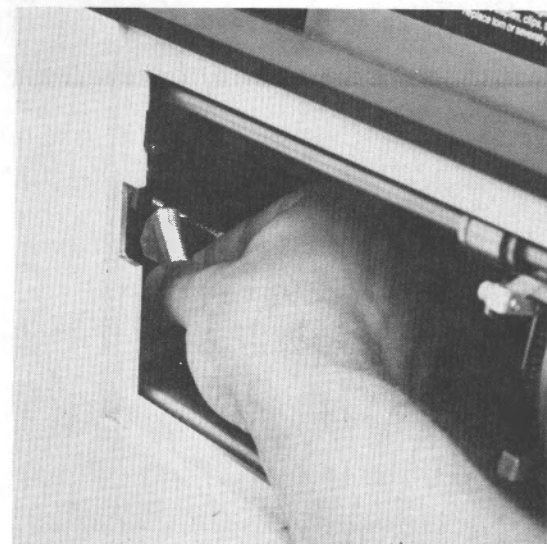
10. When printing stops, open the cover, remove the cleaning brush assembly (see "Ink Roll Removal"), close the cover, and key in the 066 command.
11. Return the cleaning brush assembly to its protective package and store it in a convenient place for future use.
12. When printing stops, open the cover, install the ink roll assembly (see "Ink Roll Replacement"), and close the cover.
13. Check the printed characters. If any character is not printing fully and clearly, repeat this print wheel cleaning procedure from the beginning.
14. If the printing appears light, repeat steps 8 and 9 until the printing is acceptable.

### Print Wheel Wiper Removal

1. Open the front cover. (See "Opening and Closing the Covers.")
2. Push the print unit all the way to the right.



3. With your right hand, pull the wiper holder until it snaps loose from the spring bracket.
4. Dispose of the old wiper assembly.





### Print Wheel Wiper Replacement

1. Remove the new wiper assembly from its protective package.
2. Hold the wiper with your right hand with the holding tabs to the top, and push the wiper assembly up from the bottom of the mounting block until it snaps into place on the mounting block.



## Contents – 3611 Passbook Printer

|   |    |
|---|----|
| Operating Controls and Lights .....                     | 1  |
| ON/OFF Switch .....                                     | 1  |
| START PRINT and STOP PRINT Switches .....               | 1  |
| READY Light .....                                       | 2  |
| 1 and 2 Lights .....                                    | 2  |
| Supplies .....  | 2  |
| Cleaning Procedures .....                               | 2  |
| Operating Procedures .....                              | 2  |
| Opening the Cover .....                                 | 2  |
| Closing the Cover .....                                 | 3  |
| Inserting Passbooks, Cut-Form Pads, and Cut Forms ..... | 4  |
| Passbook and Cut Form Jam Removal .....                 | 5  |
| Ink Roll Removal .....                                  | 8  |
| Ink Roll Replacement .....                              | 9  |
| Cleaning the Print Wheel .....                          | 11 |
| Print Wheel Wiper Removal .....                         | 12 |
| Print Wheel Wiper Replacement .....                     | 13 |

This page precedes the Unit Operating Procedures, 3611 Passbook Printer page 1.



Contents - 3811 LaserJet Printer

Operating Controls and Lights

ONCT Switch

START PRINT and STOP PRINT Switches

READY Light

1 and 2 Lights

Supplies

Cleaning Procedures

Operating Procedures

Opening the Cover

Closing the Cover

Inserting Paper, Carriage, and Carriage

Printer and Carriage Removal

Ink Roll Removal

Ink Roll Replacement

Cleaning the Print Wheel

Print Wheel Removal

Print Wheel Wiper Replacement

3811 LaserJet Printer

The only way to get the most out of your 3811 LaserJet Printer is to read this manual.

## IBM 3611 Passbook Printer

There are two models of the 3611 printer. The Model 1 can print on passbooks, on statements or receipts in pad form, and on cut forms. All of these items are of the same width as the space between the two edge guides.

The 3611-2 can print on multi-width horizontal-fold passbooks of the same length or on single-width vertical-fold passbooks and on multi-width cut forms that are guided on the left edge. (The 3611-2 has only the left-edge guide.)

The flat-top cover of the 3611 is designed to support a 3604 Keyboard Display. For a description of the 3611 Passbook Printer, refer to *Introducing the IBM 3600 Finance Communication System, GA27-2764*.

**Note:** *The 3611 Model 1 has been used for the illustrations in this chapter; the Model 2 and its operation are identical, except the right-edge guide is not present.*

### OPERATING CONTROLS AND LIGHTS

#### ON/OFF Switch

Press ON of the ON/OFF switch to apply power to your 3611. When you want to turn off the 3611, simply press OFF.

**CAUTION:** Pressing the ON/OFF switch to ON or OFF may cause errors on other terminals if they are in use on the same loop.

Turning the power off, in addition to conserving energy, activates a bypass circuit that functionally removes the unit from the loop without disconnecting the cables. This circuit provides a simple and rapid means to restore the loop operation if the terminal should malfunction.

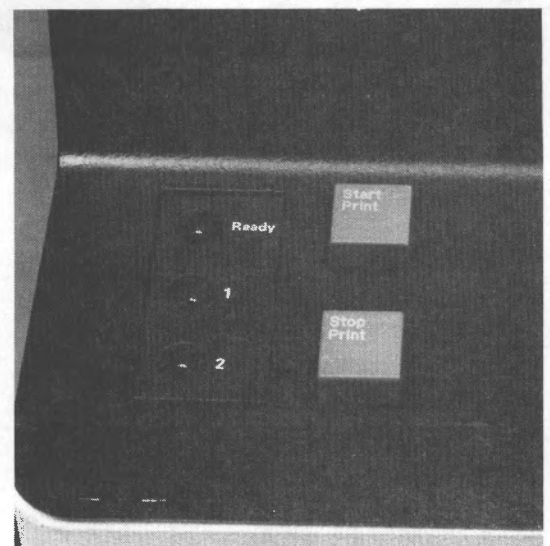
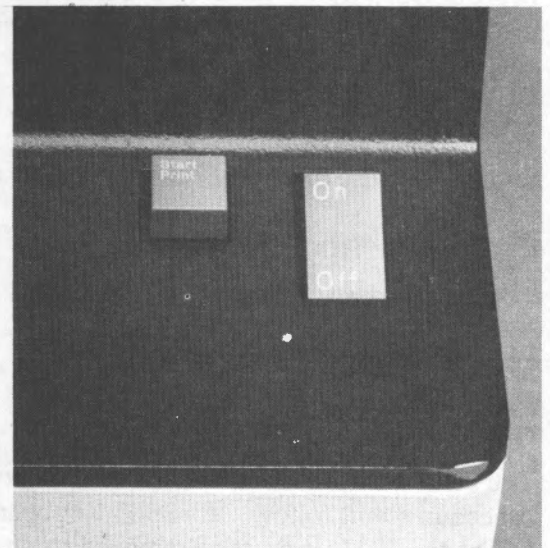
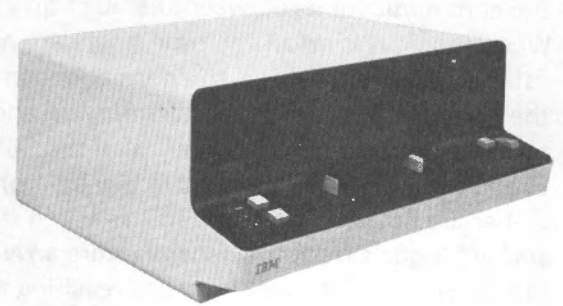
There is, however, a possible loop cable length problem between the units with power on; for details, refer to the *IBM 3600 Finance Communication System Configurator, GA27-2762*.

#### START PRINT and STOP PRINT Switches

Press the START PRINT switch when you want to start printing. The passbook or the cut form must be inserted first. Pressing the START PRINT switch tells the controller that the 3611 is ready for the printing operation to start.

When the 3611 is a shared terminal, there are two START PRINT switches, one assigned to each work station. They are located on opposite sides of the passbook slot and operate as described above.

Press the STOP PRINT switch to stop any printing that is in progress on the 3611. When you press this switch, the motor stops and the passbook or cut form is released.



## READY Light

The condition of the READY light tells you the status of the communications between the 3611 and the controller. When the light is on all the time, there are no communications problems. This is the normal operating state. If the light is *off* all the time or *flashing* on and off, a communications problem exists between the 3611 and the controller. When it's *always off*, signals from the controller are not arriving at the 3611. When it's *flashing on and off*, signals from the controller are arriving at the 3611 but signals from the 3611 are not reaching the controller.

## 1 and 2 Lights

The name and function of the 1 and 2 lights are determined by your institution. Refer to the description of these lights provided by your institution; it should be placed in this chapter of the operating guide.

## SUPPLIES

Supplies for the 3611 are listed under "Installation Details."

## CLEANING PROCEDURES

To clean the covers, use warm water and a mild detergent.

## OPERATING PROCEDURES

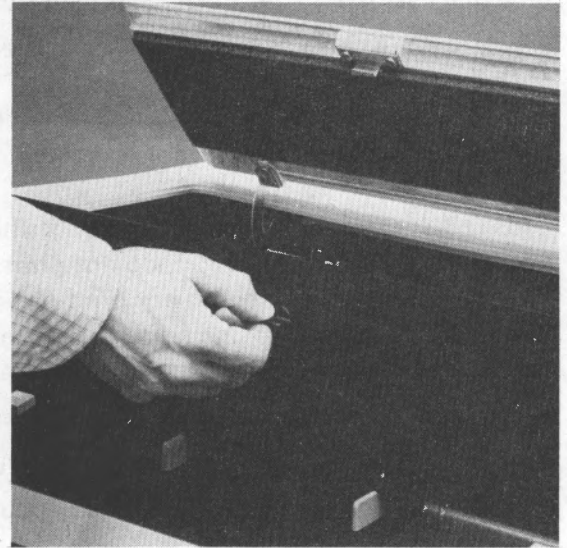
### Opening the Cover

The 3611 cover must be opened to do many of the procedures that follow. If a 3604 Keyboard Display sits on top of the 3611, it must be removed to open the 3611 cover.

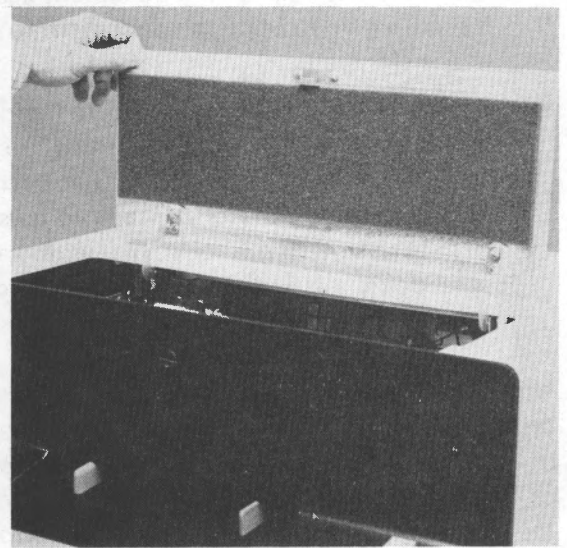
**Note:** *There is an interlock to disable the 3611 when the cover is open; be sure the printwheel has stopped turning before proceeding.*



1. Turn the cover latch to the right to the horizontal position; the cover pops open.

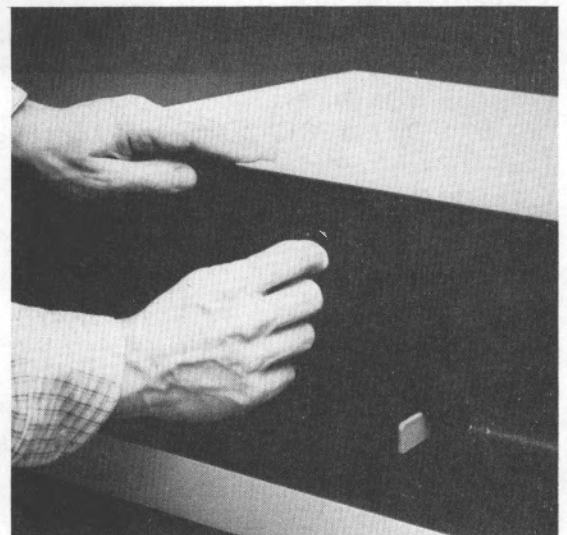


2. Push the cover up to the vertical position. The cover will stay in this open position.



#### Closing the Cover

1. Push the cover down and hold it in place.
2. Turn the cover latch to the left to the vertical position to lock the cover.



### Inserting Passbooks, Cut-Form Pads, and Cut Forms

Passbooks, cut-form pads, and cut forms are inserted in the printers in the same way. Although the following procedure describes how to insert a passbook, it should also be used to insert cut-form pads and cut forms.

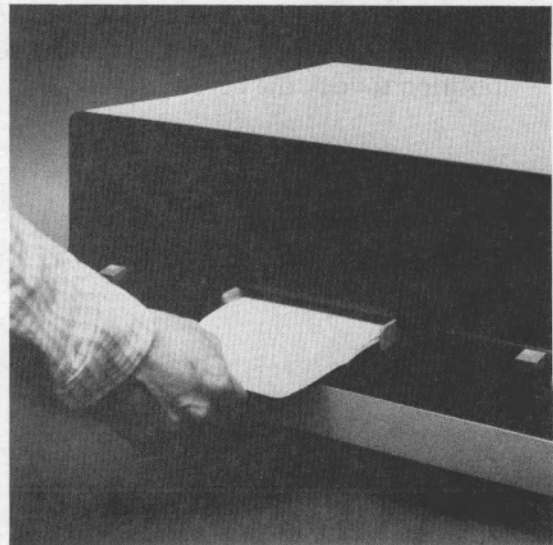
**CAUTION:** To avoid damaging the printwheel of the document printing mechanism, do not print off the edge of the document and do not print over or in holes, turned-over edges, folds (including the normal fold), stamps, staples, paper clips, or severely warped pages.

- Remove staples, clips, tape, and other material.
- Flatten folded, damaged, or dog-eared documents.
- Replace torn or severely damaged documents, or manually process them.
- Align the left edge of the document against the left-edge guide. Slide the document in until it stops and is clamped.
- Each 3611-1 has been adjusted to handle only one width passbook; do not attempt to use passbooks of any other width. Each 3611-2 has been adjusted to handle multi-width horizontal-fold passbooks, all with the same length, or single-width vertical-fold passbooks. Also, do not interchange horizontal and vertical fold passbooks in either unit.

**Note:** *When printing, the passbook must be inserted before the START PRINT switch is pressed. Many passbook printing problems (such as angled-printing, offset-printing, or over-printing) can be caused by feeding the passbooks into the printer incorrectly. Always use the following procedure:*

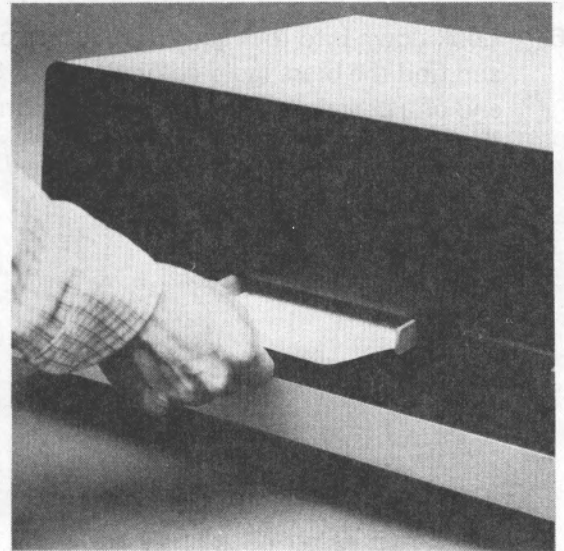
To insert a passbook:

1. Place the flattened passbook squarely in the slot:
  - a. On the 3611-1, between the left- and right-edge guides.
  - b. On the 3611-2, against the left-edge guide.





2. Hold the passbook lightly and slide it along the left guide into the slot until it is stopped and clamped. Let go of the passbook at this point. The printer will position the passbook to the line that is to be printed.



### Passbook and Cut Form Jam Removal

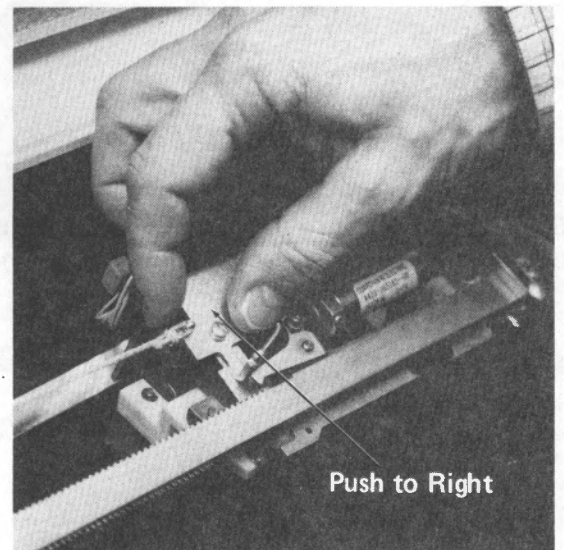
Although the following procedure describes how to remove a jammed passbook, it also applies to a jammed cut form.

If you cannot remove a passbook from the printer, proceed as follows:

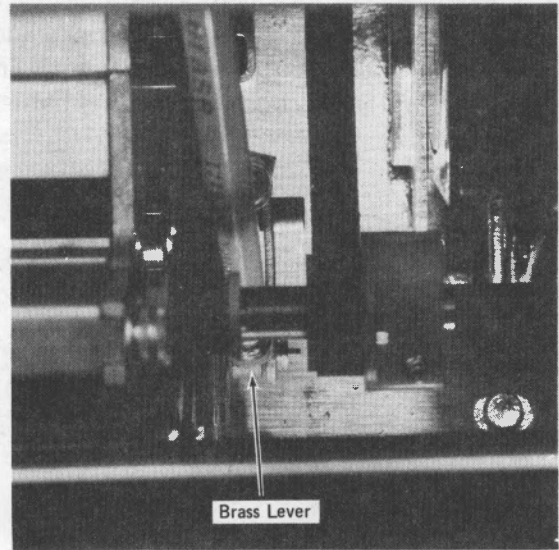
1. Press the STOP PRINT switch.
2. If the passbook is not sticking out of the slot, go to step 10.
3. If enough of the passbook is sticking out of the slot to allow you to grasp it firmly, try to pull it straight out of the printer.

If the passbook cannot be pulled out:

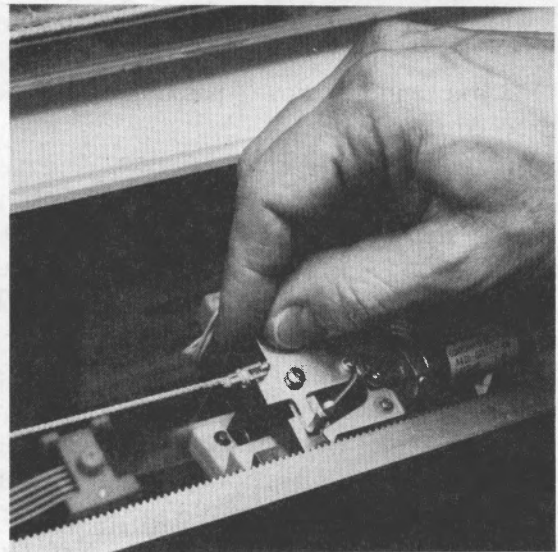
4. Open the cover. (See "Opening the Cover.")
5. If the print unit is not at the left side, move it to the left side as follows. Hold the print unit with your right hand to control it when it starts to move. With your right thumb, push the top of the carrier return pawl to the right. This action lifts the carrier return pawl, and the print unit is free to move to the left. Move the print unit slowly all the way to the left.



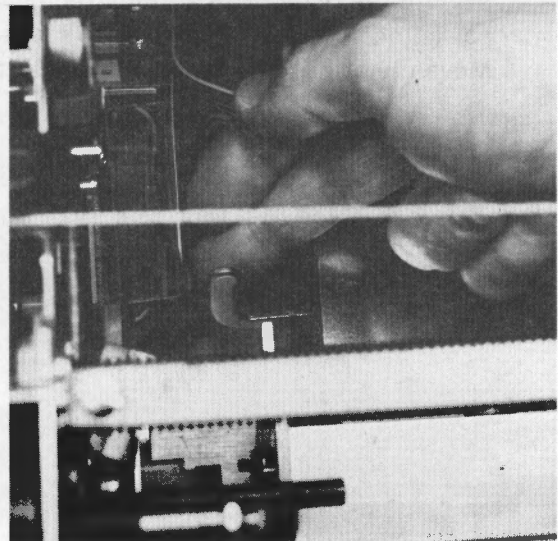
6. Look down into the right front corner of the printer and find the brass (gold-colored) lever. Using the eraser end of a pencil, or something similar, press the lever firmly downward.



7. Push the print unit all the way to the right.



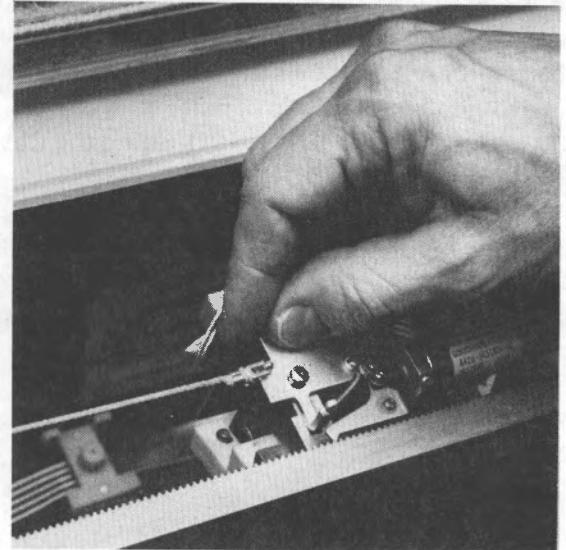
8. Look down into the left side of the printer and find the small yellow-marked handle. Push the handle toward the front of the printer.



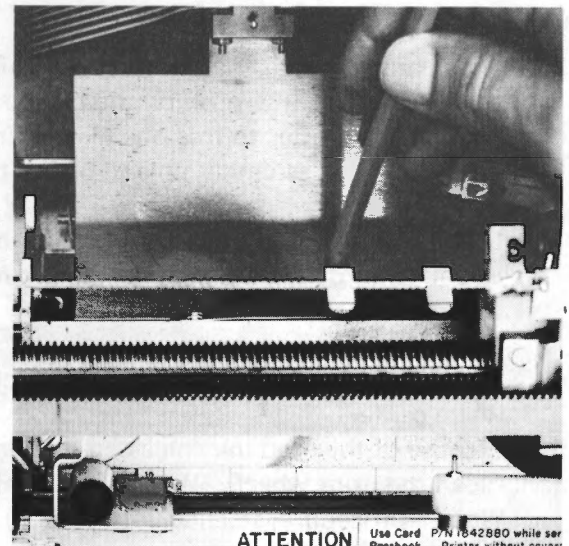
9. Pull the passbook out the passbook slot. Go to step 13.

If the passbook is not sticking out of the passbook slot:

10. If the print unit is not at the right side, push it all the way to the right.



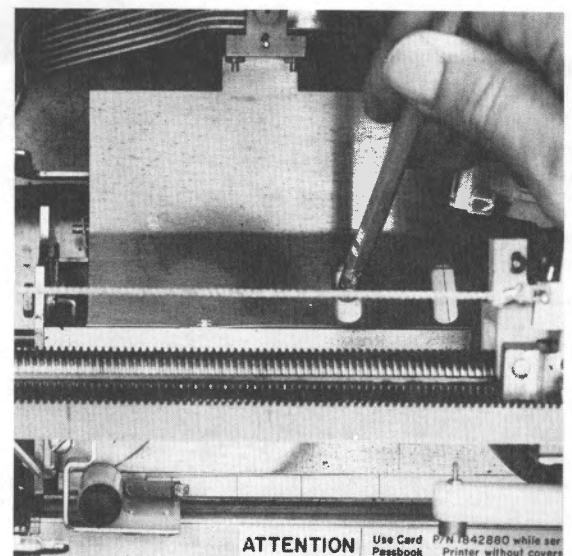
11. Look down into the center of the printer. The passbook can be seen through the two slots in the metal plate that covers the passbook. Place a pencil behind the edge of the passbook (through one of the slots in the plate) and push the passbook toward the front of the printer until you can grasp it. Then pull the passbook out the passbook slot.



12. If you can't see the edge of the passbook through the slots, use the eraser end of a pencil to move the passbook toward the front of the printer until you can grasp it. Then pull the passbook out the passbook slot.
13. Check the passbook slot and feed path and remove anything that could be causing the jam.
14. Close the cover. (See "Closing the Cover.")

**Note:** Use a "test passbook" to check the printer for normal operation before using a customer's passbook.

15. Feed a test passbook into the printer. It should be clamped and positioned for printing.
16. Press the START PRINT and then the STOP PRINT switches. The passbook should be released and come back out of the passbook slot.





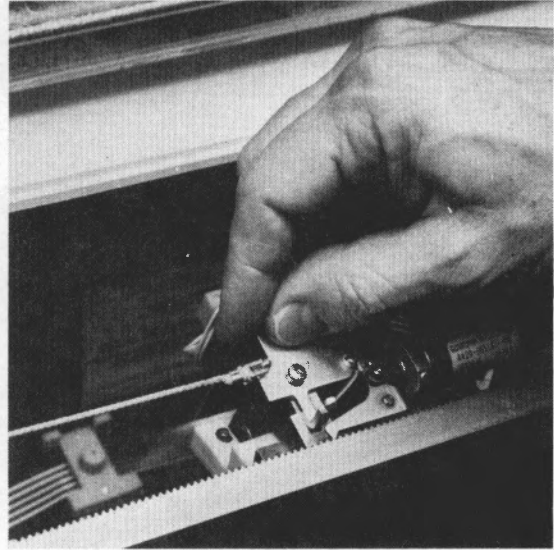
## Ink Roll Removal

Replace the ink roll when printing becomes too light. To avoid getting ink on your fingers when handling ink rolls, be careful not to touch the ink roll itself. Always pick an ink roll up by its plastic handle.

1. Open the cover. (See "Opening the Cover.")

**CAUTION:** Be sure the print wheel has stopped turning before proceeding.

2. Push the print unit all the way to the right.



3. Grasp both sides of the plastic handle of the ink roll assembly. Carefully push on the handle towards the back of the printer to free one plastic finger. Then lift the ink roll assembly up and out of the printer.

**CAUTION:** Be careful not to damage the print wheel. Do not pull up hard on the ink roll behind the print wheel.

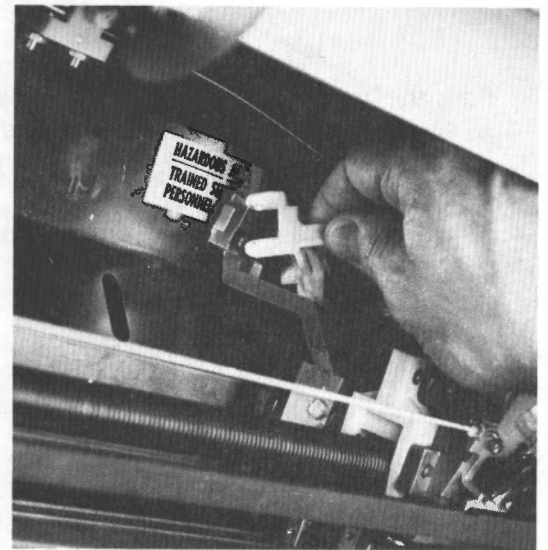
4. Check whether the ink roll has a black center or a white center.
5. Dispose of the used ink roll assembly, handle and all.
6. Clean the print wheel. (Refer to "Cleaning the Print Wheel" procedure, starting with step 3.)



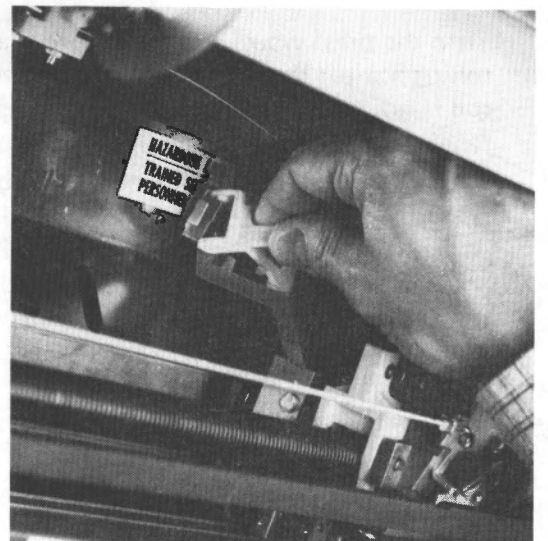
## Ink Roll Replacement

Make sure that when you replace the ink roll you install one that has the same color center as the ink roll you removed. For high-speed printers (printers that have the "Up to 30 Characters per Second" feature), use an ink roll with a white center. For low-speed printers (printers that have the "15 Characters per Second" feature), use an ink roll with a black center. The part numbers of the ink rolls are listed under "Installation Details."

1. Remove the new ink roll assembly from its protective package.
2. Grasp the plastic handle and guide the ink roll assembly down and to the right until the ink roll is behind the print wheel.

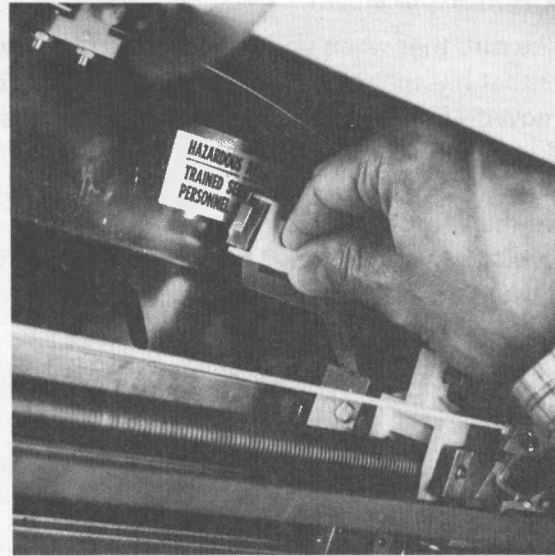


3. Place the plastic fingers directly over their notches on the mounting block.

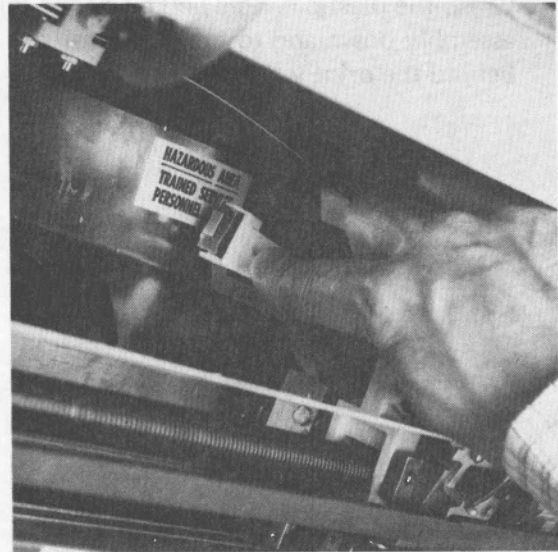




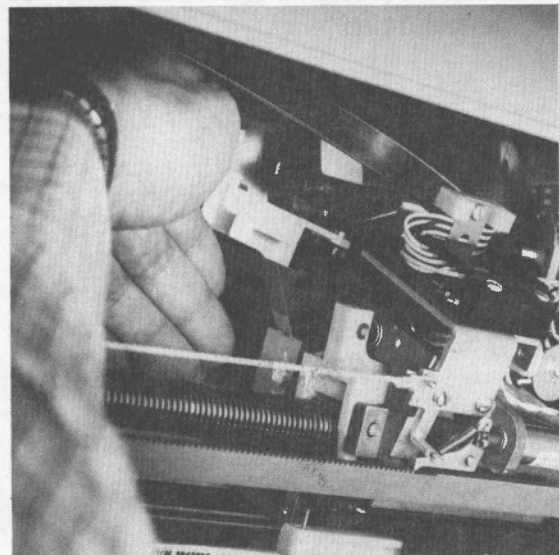
4. Push the ink roll handle down until the fingers snap onto the mounting block.



5. Push the handle of the ink roll assembly to the right, against the spring tension, several times (to test that the ink roll assembly is properly seated).



6. Turn the print wheel and make sure that the ink roll is rolling against the rear of the print wheel. If the ink roll is not rolling, remove the ink roll assembly and repeat this procedure starting from step 2.
7. After installing the new ink roll, print briefly on a test passbook to make sure that the ink roll has been correctly installed, that the print wheel is fairly clean, and that the print quality reaches a good level before restarting normal operation. To print, do the following steps:
  8. Go to a 3604 and log on as the control operator.
  9. Assign the printer using the 007 command.



10. Key in the 020 command and instruct the exerciser to run for a number of lines.

**CAUTION:** To avoid damaging the print wheel when printing on vertical-folded passbooks, select a line length so that printing does not occur on the center fold.

11. Insert a test passbook and press the START PRINT switch.
12. If the printer is a high-speed printer (it has the "Up to 30 Characters per Second" feature), the ink roll package has a print wheel wiper assembly. Put on this new print wheel wiper assembly. (See "Print Wheel Wiper Removal and Replacement Procedures.")

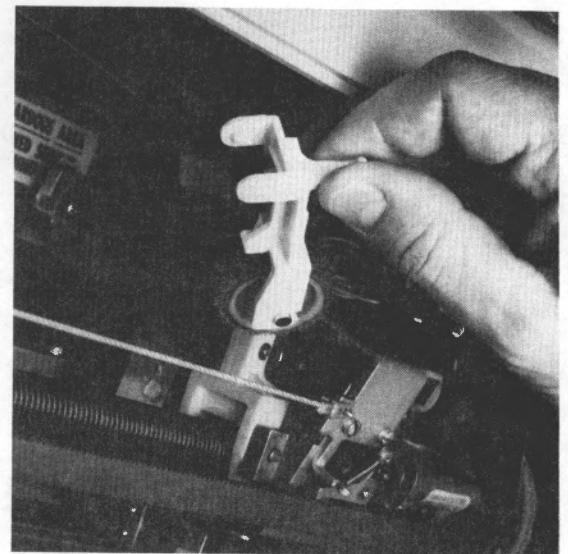
### Cleaning the Print Wheel

Clean the typeface on the print wheel when characters are not printing clearly or whenever you replace the ink roll.

To clean the print wheel, use the cleaning brush assembly (PN 1811470) which fits on the ink roll mounting block and is installed and removed in the same way as the ink roll assembly. Therefore, to install and remove the cleaning brush assembly, use the "Ink Roll Removal" and "Ink Roll Replacement" procedures.

**CAUTION:** The cleaning brush assembly must be used dry. Cleaning fluid, solvent, or paste must not be applied to the cleaning brush or print wheel at any time.

1. Open the cover. (See "Opening the Cover.")
2. Remove the ink roll assembly. (See "Ink Roll Removal.")
3. Remove the cleaning brush assembly from its protective package.
4. Install the cleaning brush assembly. (See "Ink Roll Replacement.") If the cleaning brush is not rolling after installation, remove it using the "Ink Roll Removal" procedure and repeat step 4.
5. Close the cover. (See "Closing the Cover.")
6. Go to a 3604 and log on as the control operator.
7. Assign the printer using the 007 command.
8. Key in the 066 command.
9. Insert a "test passbook" in the printer.
10. Press the START print switch if printing does not begin. (Printing will stop after 20 lines or when the end of the passbook page is reached, whichever comes first, or if an error occurs.)

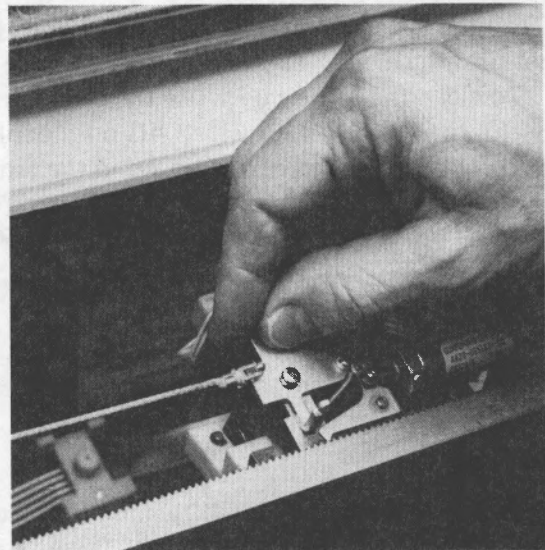


11. When printing stops, open the cover and remove the cleaning brush assembly. (See "Ink Roll Removal.") Close the cover, and key in the 066 command.
12. Return the cleaning brush assembly to its protective package and store it in a convenient place for future use.
13. When printing stops, open the cover, install the ink roll assembly (see "Ink Roll Replacement"), and close the cover.
14. Check the printed characters. If any character is not printing fully and clearly, repeat this print wheel cleaning procedure from the beginning.
15. If the printing appears light, repeat steps 8, 9, and 10 until the printing is acceptable.

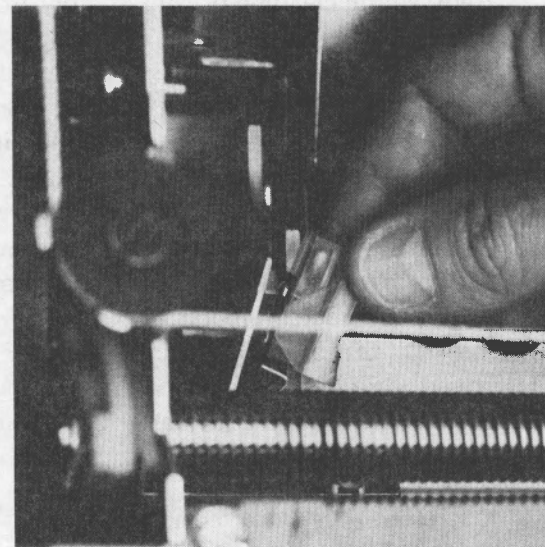
### Print Wheel Wiper Removal

High-speed printers (they have the "Up to 30 Characters per Second" feature) have a felt print wheel wiper to wipe excessive ink from the edge of the print wheel. It must be replaced when it gets full of ink or clogged with paper dust.

1. Open the cover. (See "Opening the Cover.")
2. Push the print unit all the way to the right.



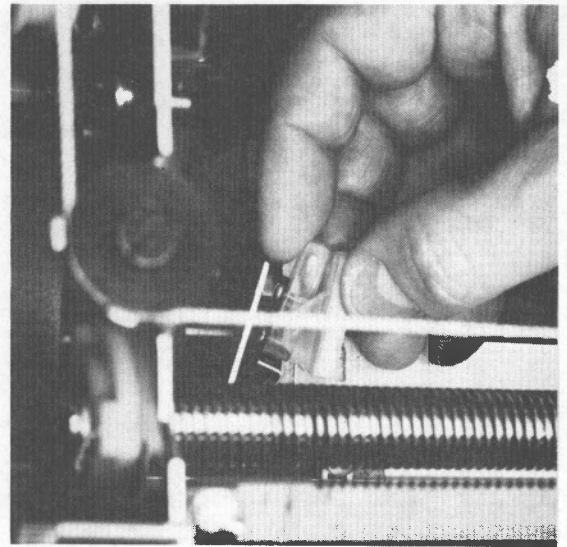
3. Pull the wiper holder to the rear of the printer until it snaps loose from the spring bracket.
4. Dispose of the old wiper assembly.



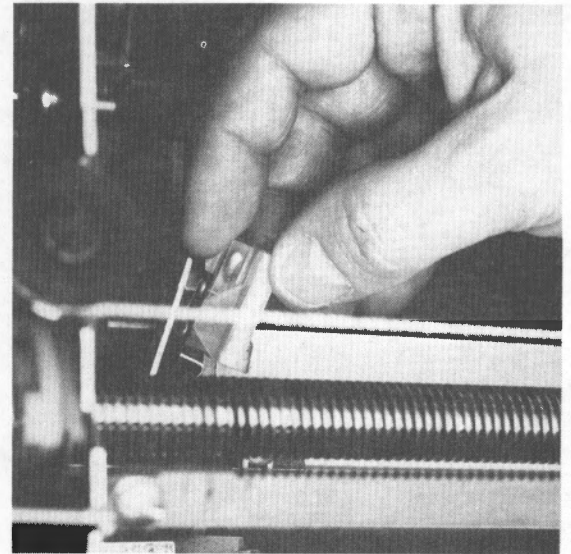


### Print Wheel Wiper Replacement

1. Remove the new wiper assembly from its protective package.
2. Place a finger behind the plastic mounting block to hold the spring bracket and to provide support for the mounting block.



3. Push the wiper assembly in place on the plastic mounting block.



1. The first step in the process is to identify the problem. This involves gathering information about the situation and determining what the goal is. Once the problem is identified, the next step is to develop a plan. This involves determining the steps that need to be taken to solve the problem. The final step is to implement the plan and evaluate the results. If the results are not satisfactory, the process may need to be repeated.

2. The second step in the process is to develop a plan. This involves determining the steps that need to be taken to solve the problem. The final step is to implement the plan and evaluate the results. If the results are not satisfactory, the process may need to be repeated.



## Contents — 3612 Passbook and Document Printer

|  |    |
|--|----|
| Operating Controls and Lights .....                          | 1  |
| ON/OFF Switch .....  | 1  |
| START PRINT and STOP PRINT Switches .....                    | 1  |
| READY Light .....  | 2  |
| 1 and 2 Lights .....   | 2  |
| Cut Forms Margin Guide .....                                 | 2  |
| Cut Forms Stop Selector .....                                | 3  |
| Forms Advance Knob, Continuous Forms Printer (Model 3) ..... | 3  |
| Forms Advance Knob, Journal Roll Printer (Model 2) .....     | 3  |
| Forms Control Rod, Journal Roll Printer (Model 2) .....      | 4  |
| Supply Roll Guide, Journal Roll Printer (Model 2) .....      | 4  |
| Supplies .....   | 4  |
| Cleaning Procedures .....                                    | 5  |
| Operating Procedures .....                                   | 5  |
| Opening the Cover .....                                      | 5  |
| Closing the Cover .....                                      | 6  |
| Inserting Cut Forms .....                                    | 6  |
| Inserting Passbooks .....                                    | 7  |
| Passbook Jam Removal .....                                   | 8  |
| Journal Roll Removal .....                                   | 12 |
| Loading Journal Rolls .....                                  | 13 |
| Loading Continuous Forms .....                               | 18 |
| Ink Roll Removal, Document Printer .....                     | 23 |
| Ink Roll Replacement, Document Printer .....                 | 24 |
| Ink Roll Removal, Passbook Printer .....                     | 26 |
| Ink Roll, Replacement, Passbook Printer .....                | 28 |
| Cleaning the Print Wheel .....                               | 30 |
| Print Wheel Wiper Removal, Document Printer .....            | 31 |
| Print Wheel Wiper Replacement, Document Printer .....        | 32 |
| Print Wheel Wiper Removal, Passbook Printer .....            | 32 |
| Print Wheel Wiper Replacement, Passbook Printer .....        | 34 |

This page precedes the Unit Operating Procedures, 3612 Passbook and Document Printer page 1.

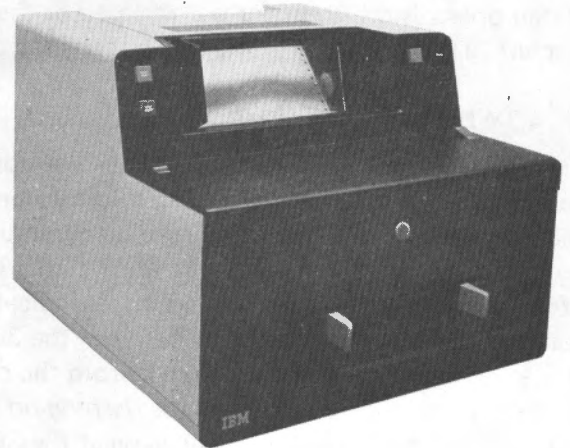
Other income  
Dividend income  
Interest income  
Rental income  
Capital gain income  
Other income

Other income  
Dividend income  
Interest income  
Rental income  
Capital gain income  
Other income

## IBM 3612 Passbook and Document Printer

The 3612 printer can print on passbooks, journal rolls, continuous forms, or cut forms. Your institution can choose from three models of 3612s to get the combination of forms desired. For a description of the 3612 Passbook and Document Printer, refer to *Introducing the IBM 3600 Finance Communication System, GA27-2764*.

**Note:** *The journal rolls usually have the last three or four feet overprinted in red to indicate the end of the roll; to prevent loss of information, replace the journal roll as soon as the overprint mark appears.*



### OPERATING CONTROLS AND LIGHTS

#### ON/OFF Switch

Press ON of the ON/OFF switch to apply power to your 3612. When you want to turn off the 3612, simply press OFF.

**CAUTION:** Pressing the ON/OFF switch to ON or OFF may cause errors on other terminals if they are in use on the same loop.

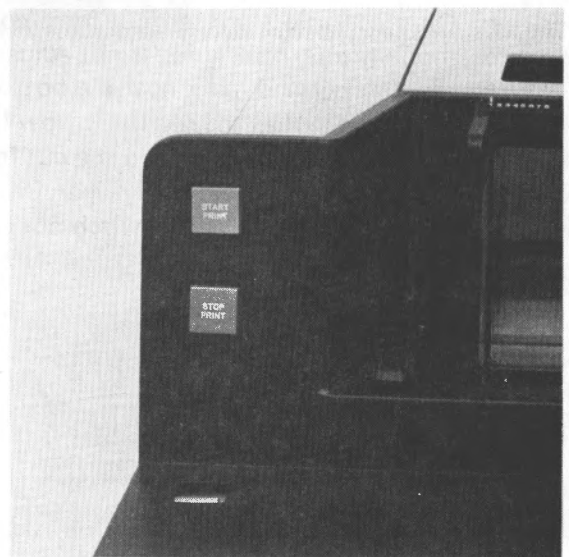
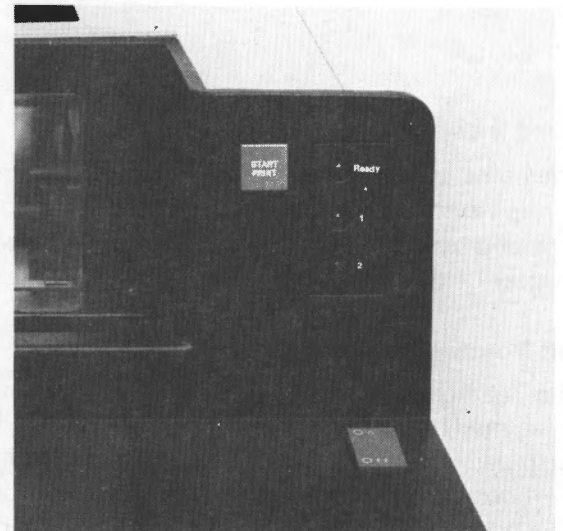
Turning the power off, in addition to conserving energy, activates a bypass circuit that functionally removes the unit from the loop without disconnecting the cables. This circuit provides a simple and rapid means to restore the loop operation if the terminal should malfunction.

There is, however, a possible loop cable length problem between the units with power on; for details, refer to the *IBM 3600 Finance Communication System Configurator, GA27-2762*.

#### START PRINT and STOP PRINT Switches

Press the START PRINT switch when you want to start printing. Paper must be in the printer, or a cut form or passbook must be inserted first. Pressing the START PRINT switch tells the controller that the 3612 is ready for the printing operation to start and activates the printer. When it is pressed, the platen of the document printer is closed and the motors are turned on, which starts the two print wheels turning. (If no data is received from the controller application program within 20 seconds, the platen is opened and the motors are turned off.)

When the 3612 is a shared printer, there are two START PRINT switches, one assigned to each work station. They are located on opposite sides of the printer and operate as described above.

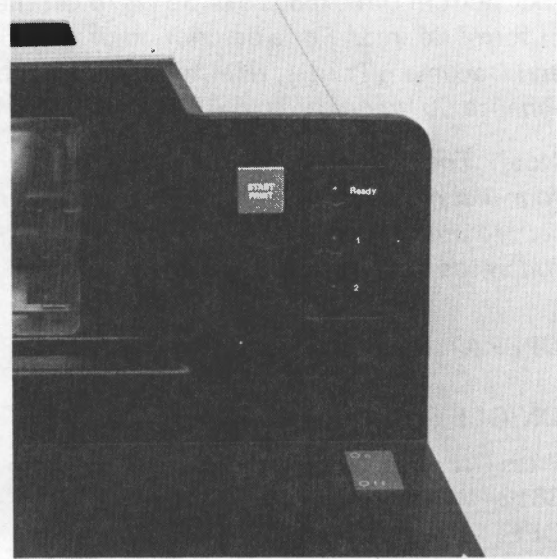




Press the STOP PRINT switch to stop any printing that is in progress on the 3612. When you press this switch, the platen opens and the cut form is released or the passbook is ejected. The motors turn off, which stops the print wheels.

### READY Light

The condition of the READY light tells you the status of the communications between the 3612 and the controller. When the light is on all the time, there are no communications problems. This is the normal operating state. If the light is off all the time or flashing on and off, it indicates that a communications problem exists between the 3612 and controller. When it's *always off*, signals from the controller are not arriving at the 3612. When it's *flashing on and off*, signals from the controller are arriving at the 3612 but signals from the 3612 are not reaching the controller.



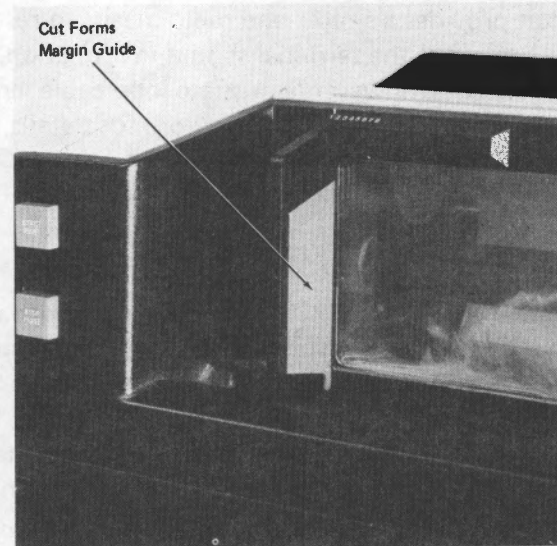
### 1 and 2 Lights

The name and function of the 1 and 2 lights are determined by your institution. Refer to the description of these lights provided by your institution; it should be placed in this chapter of the operating guide.

### Cut Forms Margin Guide

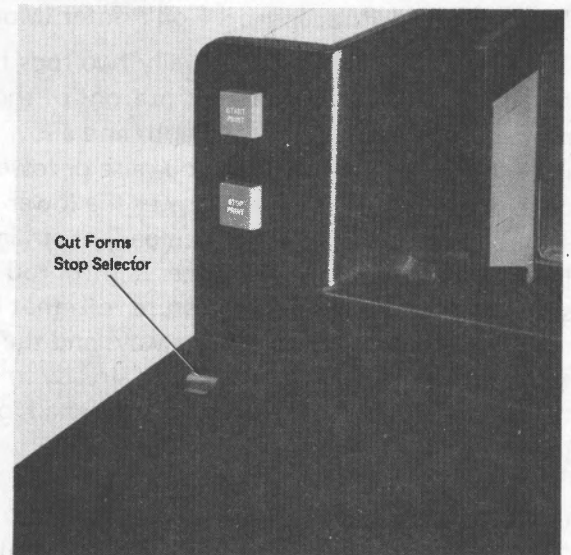
The Cut Forms Margin Guide is designed to save you time when inserting and positioning cut forms. On Model 1 (cut form/passbook printer) and Model 2 (cut form-journal/passbook printer) of the 3612, the guide can be set to any of eight positions. Squeeze the light blue insert in the guide toward you and slide the guide left or right to the desired position. On the Model 3 printer (cut form/continuous forms/passbook printer) the guide is not adjustable.

The small white scribed mark near the bottom of the blue insert is the same height as the red line below the viewing window. Together with the mark on the cut form, they can be used for proper forms positioning when inserting forms with the Cut Forms Stop Selector switch not engaged.



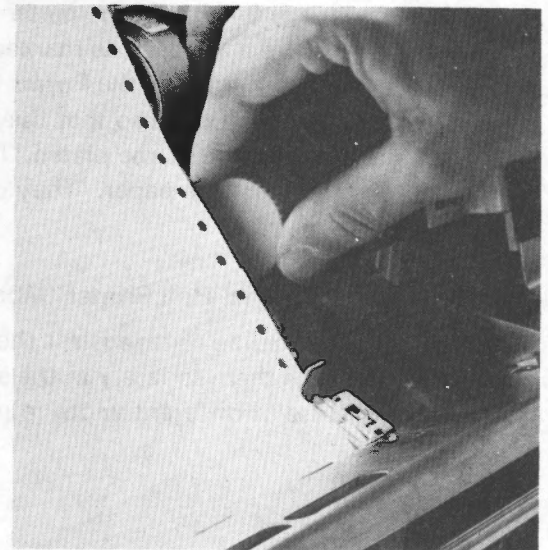
### Cut Forms Stop Selector

The Cut Forms Stop Selector is a two-position slide switch. When the slide switch is in the rear position, the depth that cut forms can be inserted into the printer is limited. In the forward position, the depth of insertion of cut forms is not limited.



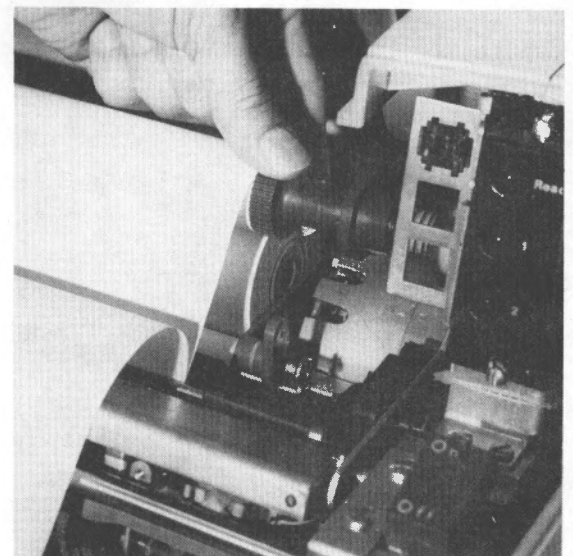
### Forms Advance Knob, Continuous Forms Printer (Model 3)

Turn this knob to move the continuous forms forward in small increments.



### Forms Advance Knob, Journal Roll Printer (Model 2)

Turn this knob to move the journal roll forward in small increments.





### Forms Control Rod, Journal Roll Printer (Model 2)

The Forms Control Rod is actually two rods that move together: an upper control rod in front of the platen (this rod can be seen in the photograph) and a lower control rod in back of the platen. When you raise or lower the upper control rod, you also raise or lower the lower control rod.

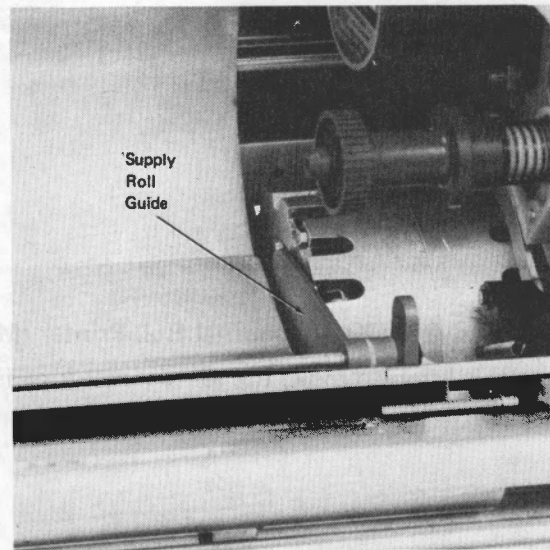
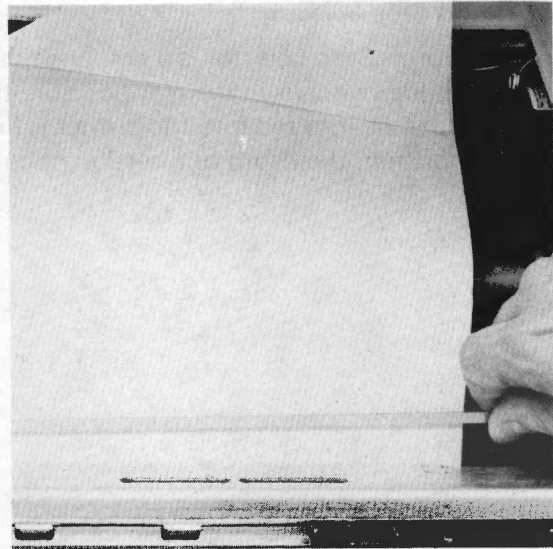
When you want to load, unload, or straighten the journal, you must raise the upper control rod to its upper stop. In that position, the pressure rolls that hold the paper against the platen are out of the way, and the forms path through the printer is open. Paper already in the machine is then loose and can be removed or realigned, or a new journal can be loaded.

#### CAUTIONS:

1. Be careful when lowering the upper control rod after you have loaded the journal. The pressure rolls can snap the paper tightly against the platen. The journal is pressure-sensitive and could be marked.
2. The spacers on both sides of the Forms Control Rod should always be positioned so that they do not touch the journal but still rest on the platen. Never move them into the path of the paper. They can cause the journal to jam or tear.

### Supply Roll Guide, Journal Roll Printer (Model 2)

The blue Supply Roll Guide slides against the right end of journal rolls and keeps them squarely in the supply roll tray. It allows the use of different width journal rolls.



#### SUPPLIES

Supplies for the 3612 are listed under "Installation Details."

## CLEANING PROCEDURES

To clean the viewing window and the covers, use warm water and a mild detergent.

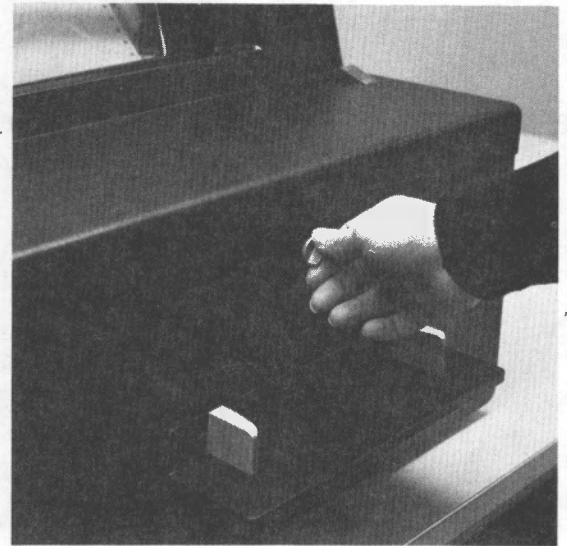
## OPERATING PROCEDURES

### Opening the Cover

The 3612 cover must be opened to do many of the procedures that follow.

**CAUTION:** Be sure the print wheel has stopped turning before proceeding; there is an interlock to disable the 3612 when the cover is open.

1. Turn the cover latch to the right to a horizontal position.



2. Lift the top cover, in one motion, until the support brackets snap into their stops at the cover's upper limit.

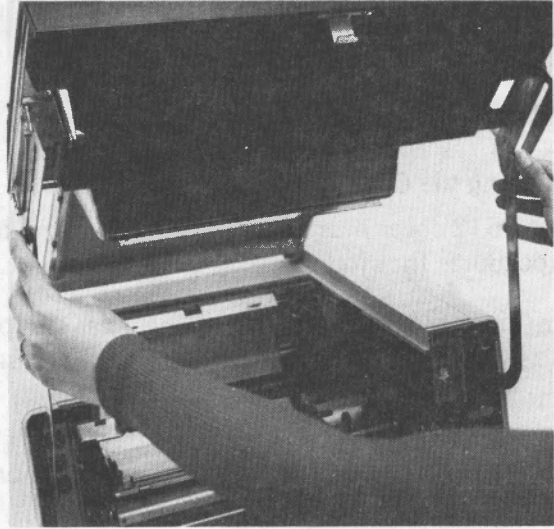
**CAUTION:** The support brackets lock and hold the cover in the open position. You must release the support stops to lower the cover. See "Closing the Cover".



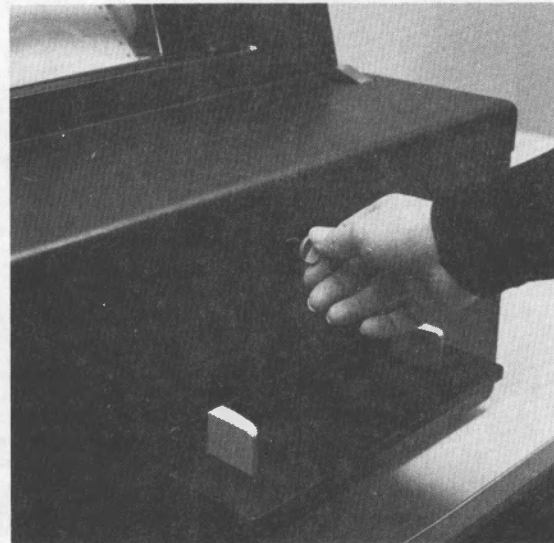
## Closing the Cover

**CAUTION:** The cover latches open. Attempting to close it without releasing the stops will damage the support arms.

1. Squeeze the support arm brackets on both arms at the same time until the brackets slide clear of the stops.
2. Lower the cover to the closed position.



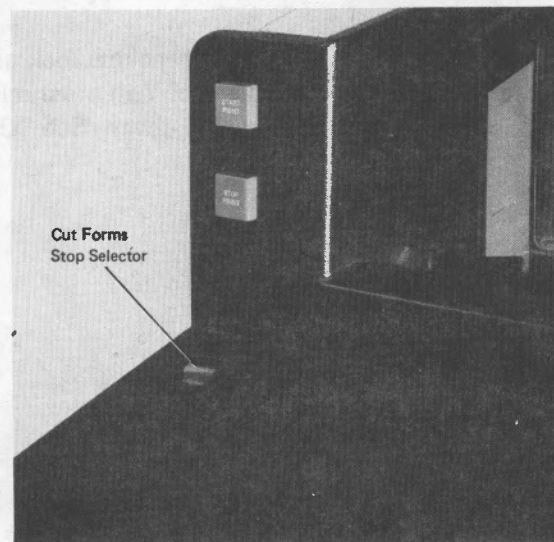
3. Turn the cover latch to the left to the vertical position to lock the cover.



## Inserting Cut Forms

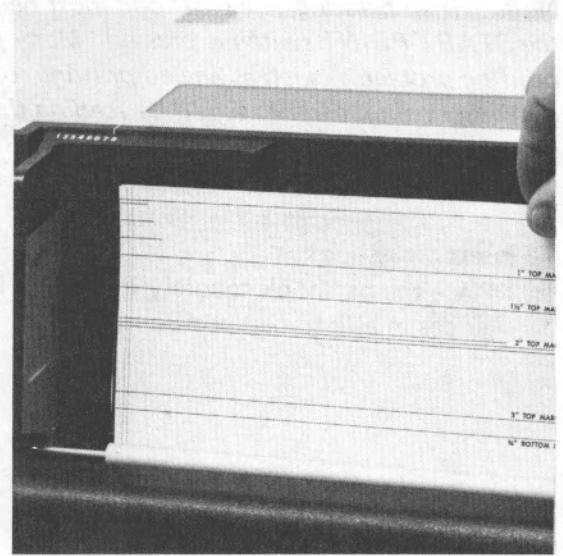
**CAUTION:** To avoid damaging the printwheel of the document printing mechanism, do not print off the edge of the document and do not print over or in holes, turned-over edges, folds (including the normal fold), stamps, staples, paper clips, or severely warped pages.

- Remove staples, clips, tape, and other material.
  - Flatten folded, damaged, or dog-eared documents.
  - Replace torn or severely damaged documents, or manually process them.
  - Align the left edge of all documents to the Cut Forms Margin Guide.
1. Press the STOP PRINT switch.
  2. Slide the Cut Forms Stop Selector to the rear position to limit the depth to which cut forms can be inserted. Move it to the forward position to allow full insertion of the cut forms.



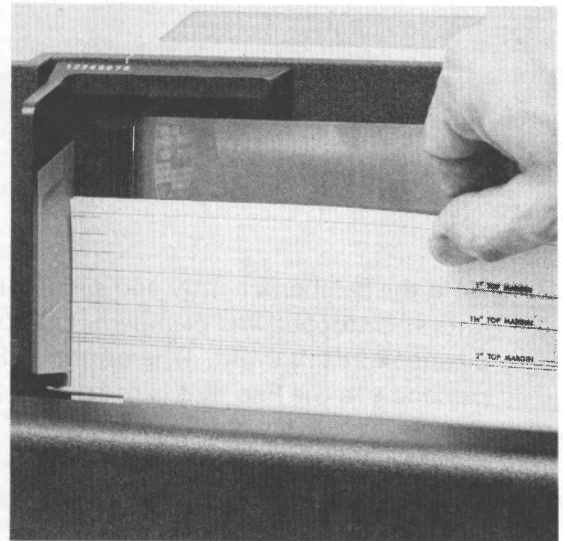


3. Insert the cut form into the slot in front of the viewing window.



4. Slide the cut form to the left until it is against the Cut Forms Margin Guide, then push it down until it reaches the bottom of the slot or to the desired depth. The small white scribed mark near the bottom of the blue insert on the guide and the red line below the viewing window can be used to position the form for proper printing.

5. Press the START PRINT switch.



### Inserting Passbooks

**CAUTION:** To avoid damaging the printwheel of the document printing mechanism, do not print off the edge of the document and do not print over or in holes, turned-over edges, folds (including the normal fold), stamps, staples, paper clips, or severely warped pages.

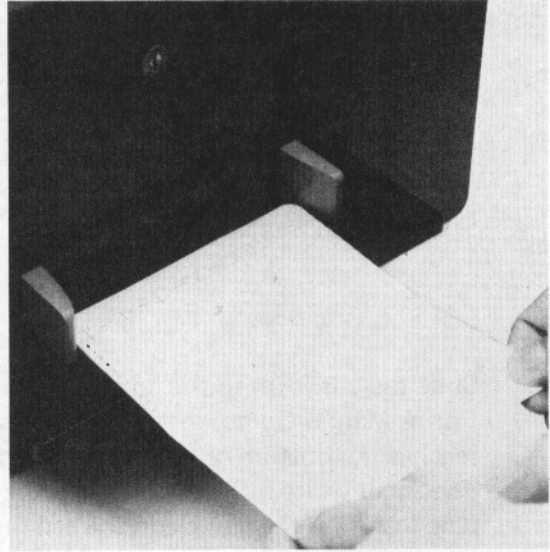
- Remote staples, clips, tape, and other material.
- Flatten folded, damaged, or dog-eared documents.
- Replace torn or severely damaged documents, or manually process them.
- Passbook width must be same as the space between the guides.
- Place the passbook squarely in the slot in a flattened position. Slide the passbook into the slot until it stops and is clamped.
- Each 3612 has been adjusted to handle only one width passbook; do not attempt to use passbooks of any other width. Also, do not interchange horizontal and vertical fold passbooks.



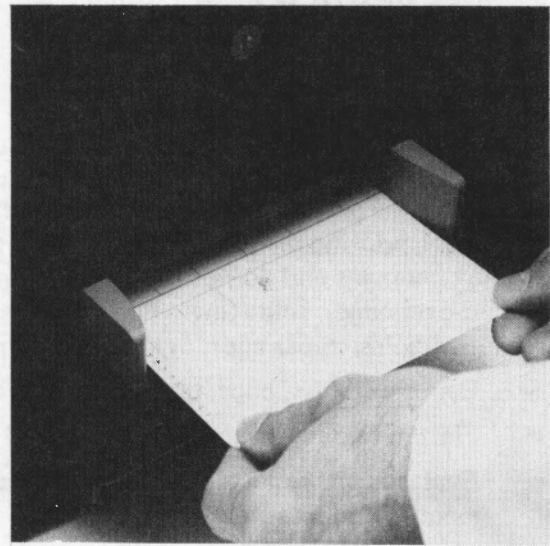
**Note:** *When printing, the passbook must be inserted before the START PRINT switch is pressed. Many passbook printing problems (such as angled-printing, offset-printing, or over-printing) can be caused by feeding the passbooks into the printer incorrectly. Always use the following procedure.*

To insert a passbook:

1. Place the passbook squarely in the slot between the guides in a flattened position.



2. Hold the passbook lightly and slide it into the slot until it is stopped and clamped. Let go of the passbook at this point. The printer will position the passbook to the line that is to be printed.



### **Passbook Jam Removal**

If you cannot remove a passbook from the printer, proceed as follows:

1. Press the STOP PRINT switch.

If the passbook does not return:

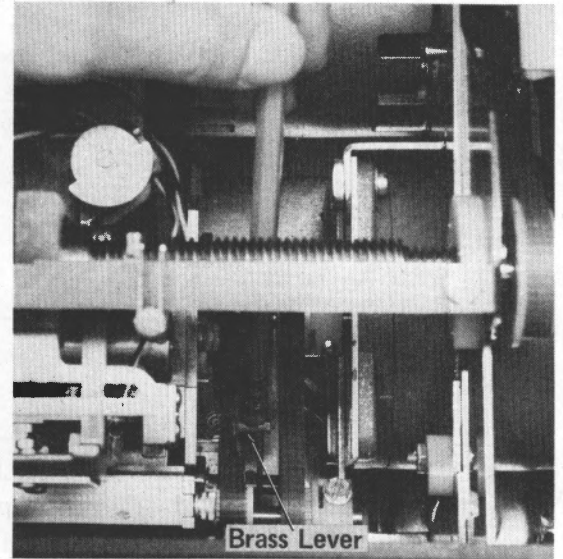
2. Press OFF on the ON/OFF switch. Wait about 5 seconds and then press ON on the ON/OFF switch.

If the passbook still does not return:

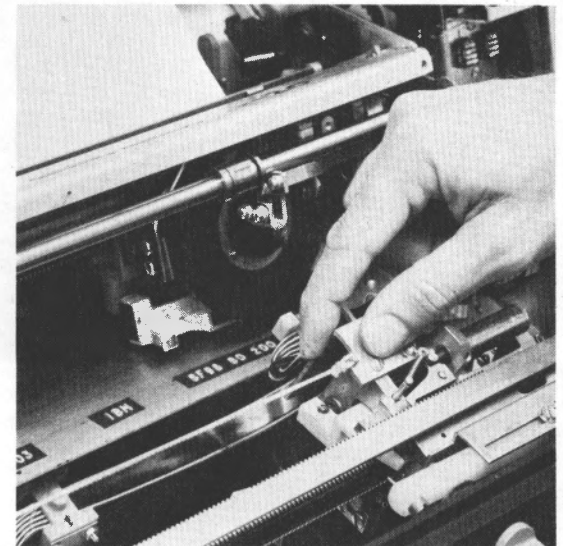
3. If enough of the passbook is sticking out of the slot to allow you to grasp it firmly, try to pull it straight out of the printer. If the passbook is not sticking out of the slot, go to step 9.

If the passbook cannot be pulled out:

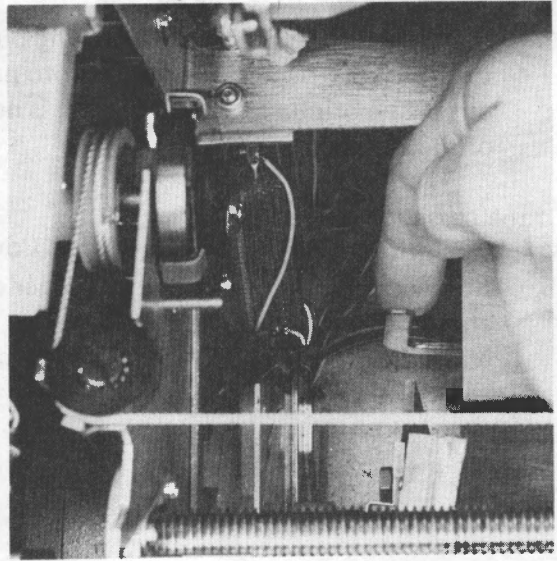
4. Open the cover. (See "Opening the Cover.")
5. Look down into the right front corner of the printer and find the brass (gold-colored) lever. Using the eraser end of a pencil, or something similar, press the lever firmly downward.



6. If the passbook print unit is positioned at the left side of the printer, push it all the way to the right.

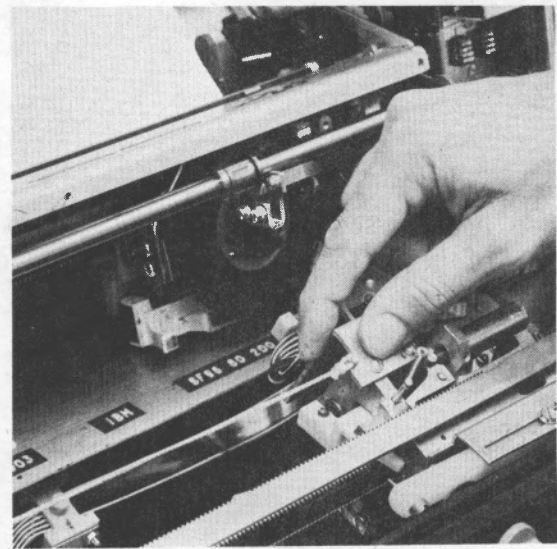


7. Look down into the left side of the printer and find the small yellow-marked handle. Push the handle toward the front of the printer.
8. Pull the passbook out the passbook slot. Go to step 12.

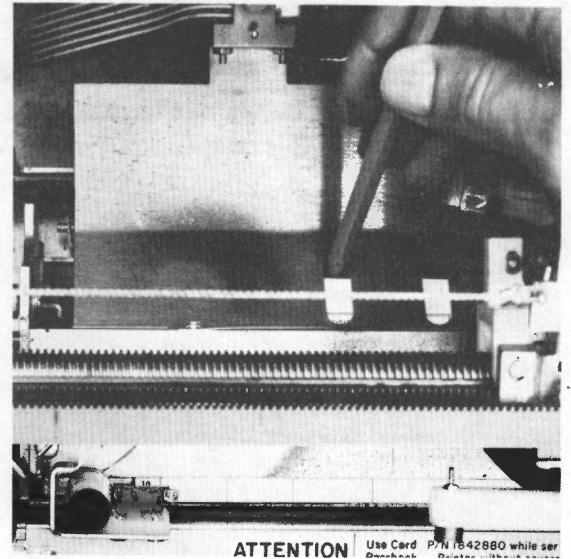


If the passbook is not sticking out of the passbook slot:

9. If the print unit is not at the right side, push it all the way to the right.



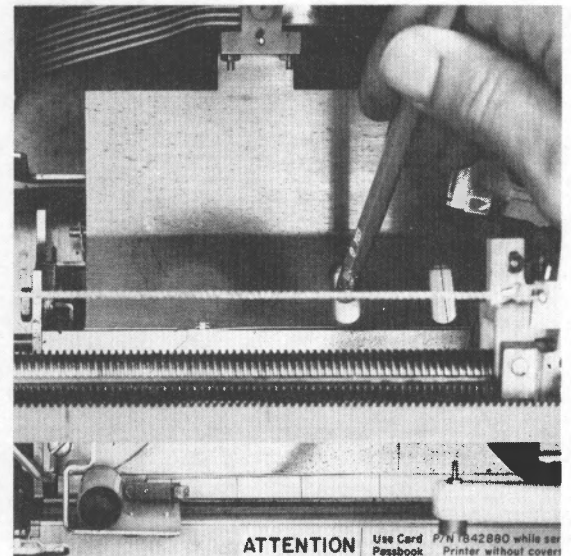
10. Look down into the center of the printer. The passbook can be seen through the two slots in the metal plate that covers the passbook. Place a pencil behind the edge of the passbook (through one of the slots in the plate) and push the passbook toward the front of the printer until you can grasp it. Then pull the passbook out the passbook slot.



11. If you can't see the edge of the passbook through the slots, use the eraser end of a pencil to move the passbook toward the front of the printer until you can grasp it. Then pull the passbook out the passbook slot.
12. Check the passbook slot and feed path and remove anything that could be causing the jam.
13. Close the cover. (See "Closing the Cover.")

**Note:** Use a "test passbook" to check the printer for normal operation before using a customer's passbook.

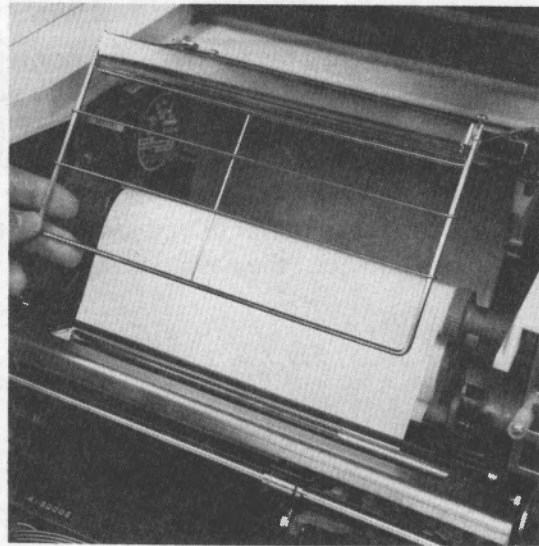
14. Feed a test passbook into the printer. It should be clamped and positioned for printing.
15. Press the START PRINT and then the STOP PRINT switches. The passbook should be released and come back out of the passbook slot.



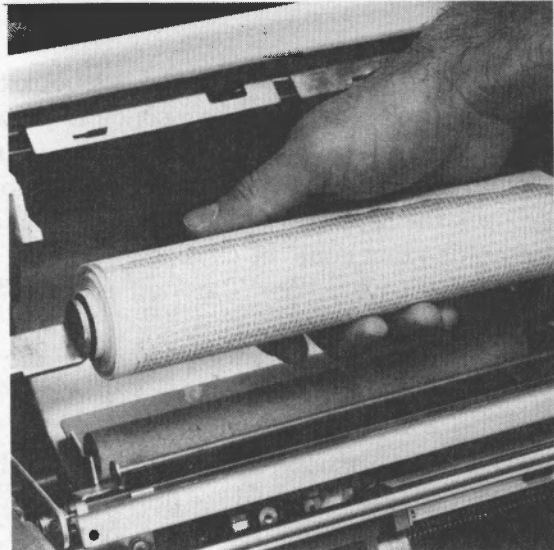


## Journal Roll Removal

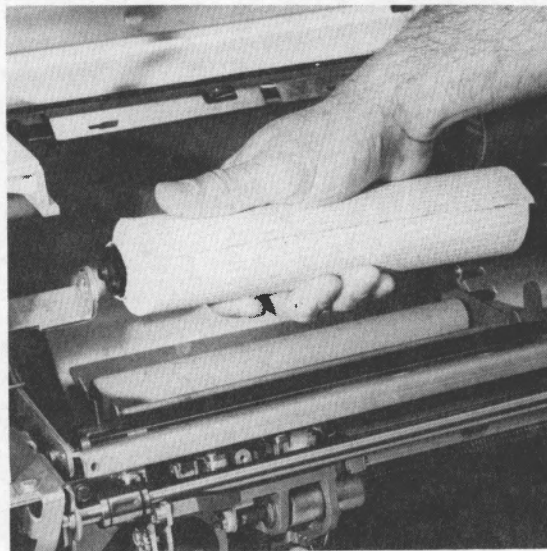
1. Press the STOP PRINT switch.
2. Open the cover (see "Opening the Cover").
- 2a. Some 3612 Model 2 units have a paper guide; carefully raise this guide up out of the way.



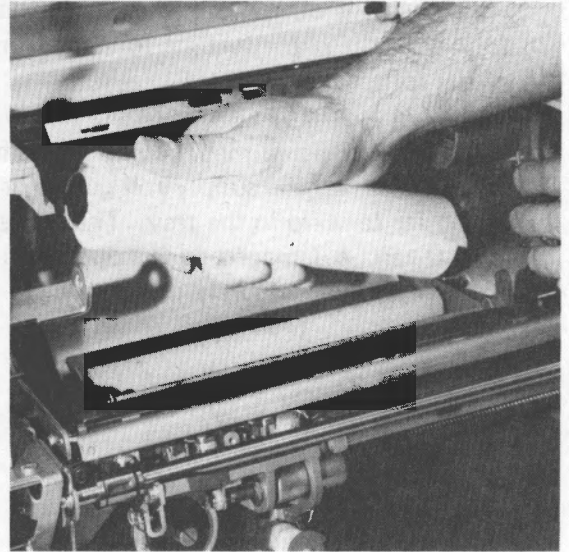
3. Wind the used journal paper onto the take-up reel by turning the roll with your hand or by using the Forms Advance Knob.



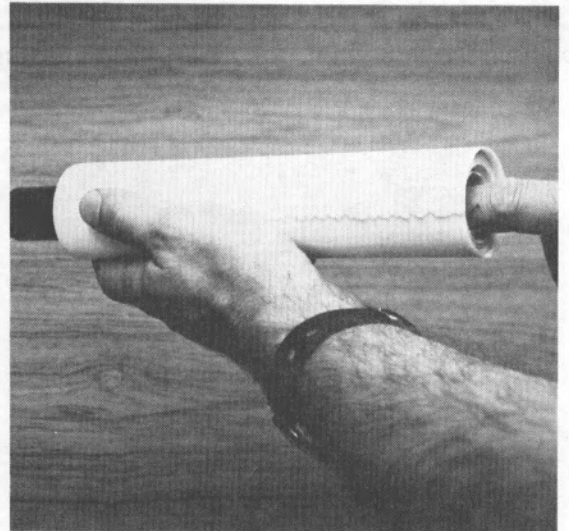
4. Grasp the used journal roll and push to the right to free the left end of the take-up reel.



5. Hold the Forms Advance Knob to the right with your free hand and lift the used journal roll from the machine.
6. If there is unused paper left on the supply roll, cut the used journal roll free.

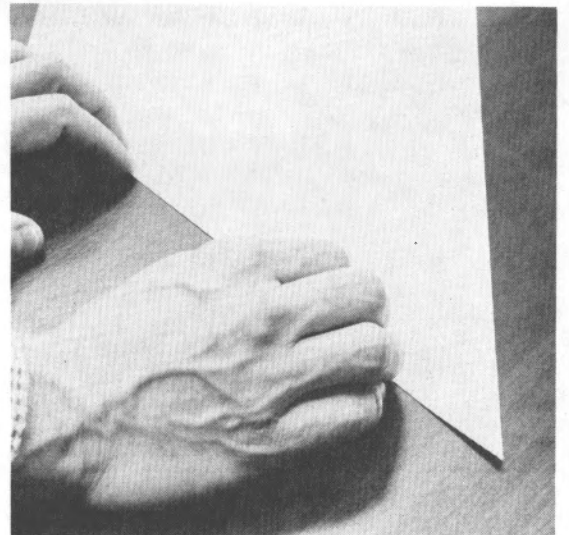


7. Remove the take-up reel by pushing it through the center of the used journal roll with your finger and then pulling it out the other end.



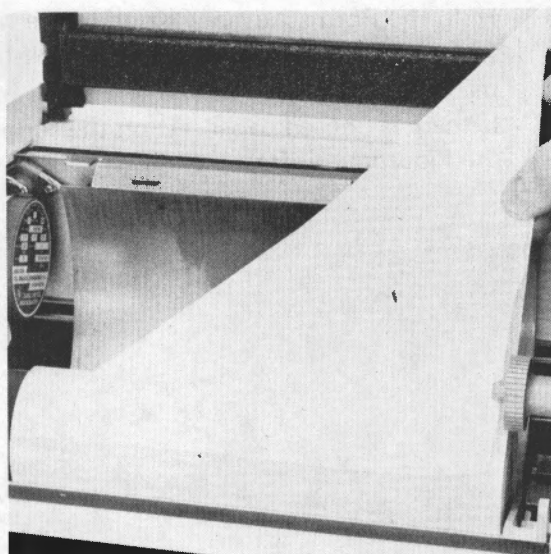
### Loading Journal Rolls

1. Press the STOP PRINT switch.
2. Open the cover. (See "Opening the Cover.")
3. Remove the completed or used portion of the journal roll (see "Journal Roll Removal"), or remove the empty take-up reel and put it aside for the moment.
4. Unroll the new or remaining journal roll that you intend to load into the machine and crease the leading edge to form a point on the right side.

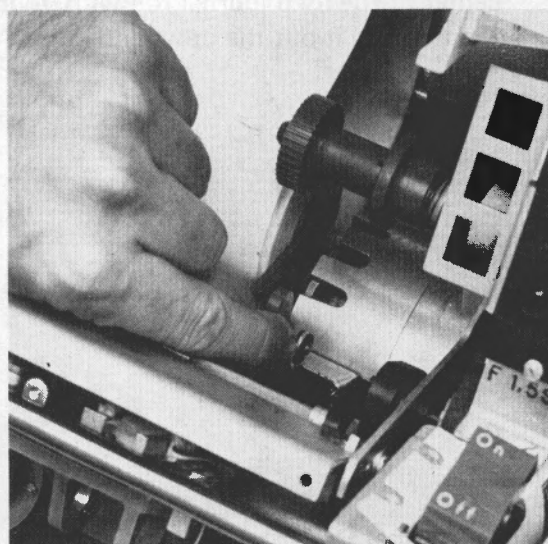


5. Place the new journal roll squarely in the supply roll tray, with the paper feeding forward from the bottom of the roll.

**CAUTION:** Be sure that the new roll is not tilted up on one end over the supply roll guides or too far back or too far forward in the tray. The edges of the journal can be damaged during operation if the roll is not positioned squarely in the tray.

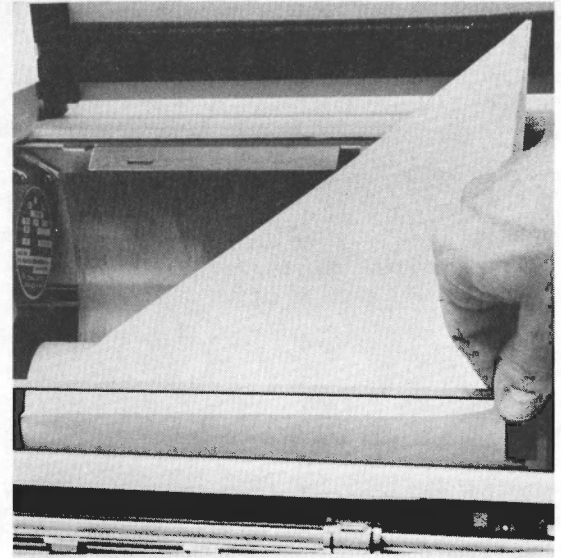


6. Slide the Supply Roll Guide to the left until it touches the end of the journal roll.

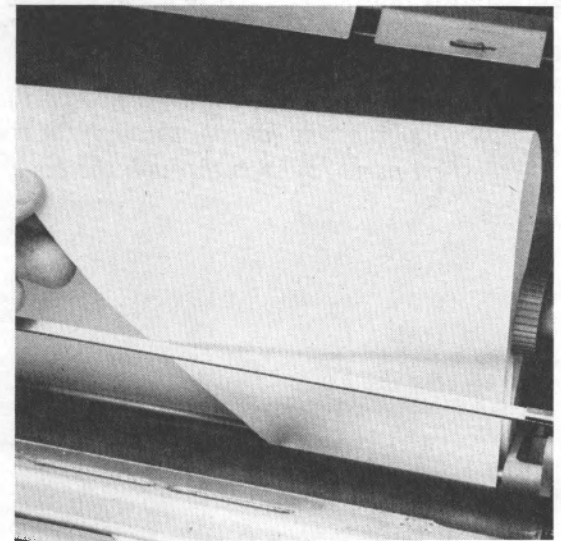




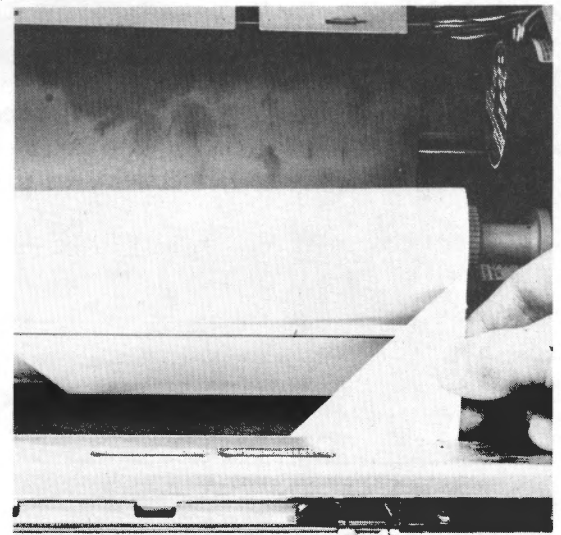
7. Lift the upper Forms Control Rod to its upper stop.



8. Slide the pointed edge of the journal behind the upper Forms Control Rod and down into the space behind the platen, between the platen and the lower Forms Control Rod.

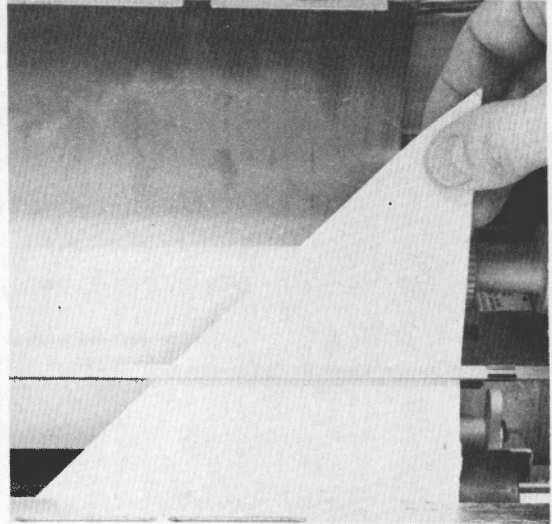


9. Push the journal down until the point comes into view in front of the platen at the right end. Keep the point next to the platen with your finger and continue pushing the journal down until they are completely around the platen and you are able to grasp the point from the top.



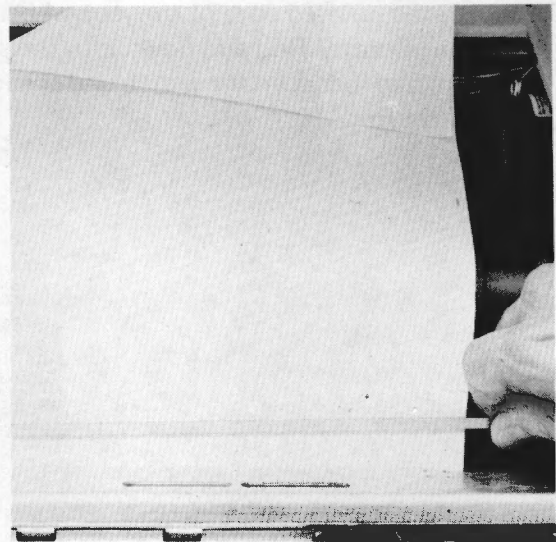


10. Feed the journal between the upper Forms Control Rod and the platen.



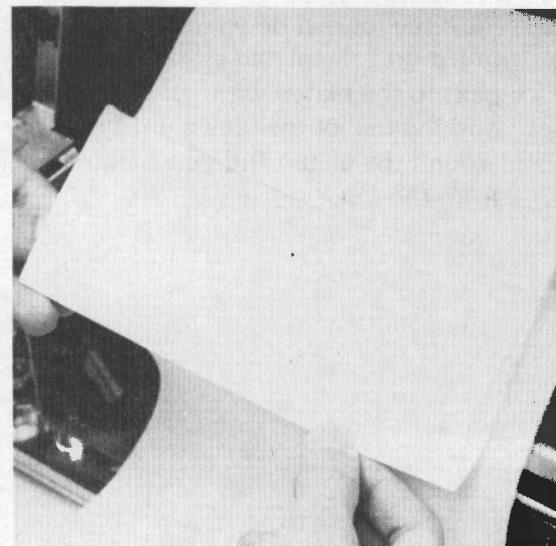
11. Pull the journal through to reach the journal take-up reel and slowly lower the upper Forms Control Rod.

**Note:** *When you are loading a two-part journal roll, pull enough of the journal through for the top sheet (the first part) to reach through the cover.*



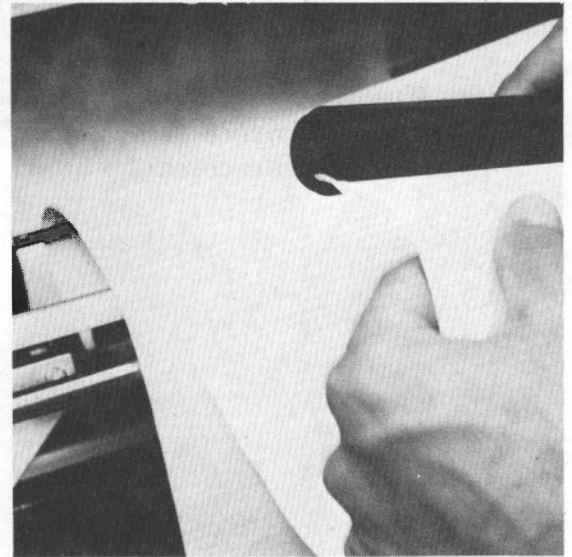
12. Unfold the pointed leading edge of the journal and refold it to make a stiff straight edge.

**Note:** *When a two-part journal roll is used, separate the two parts and refold only the part closest to the platen (the second part).*

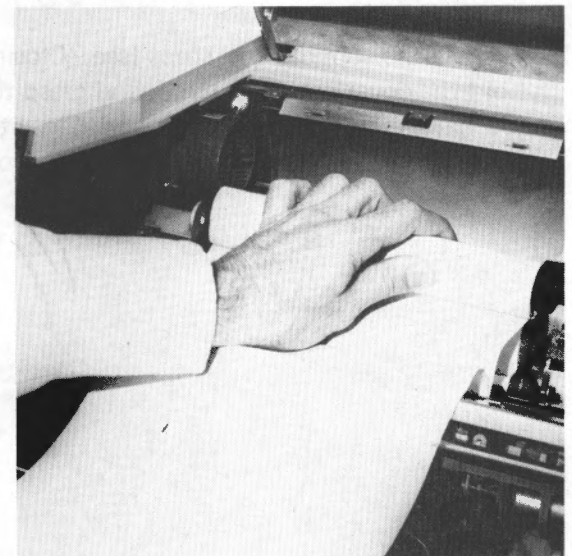


13. Insert the folded straight edge of the journal into the slot in the take-up reel, aligning the left edge with the step in the take-up reel.

**Note:** *When a two-part journal roll is used, the second part (closest to the platen) is inserted into the take-up reel. The other part (the first part) exits through the slot in the cover.*

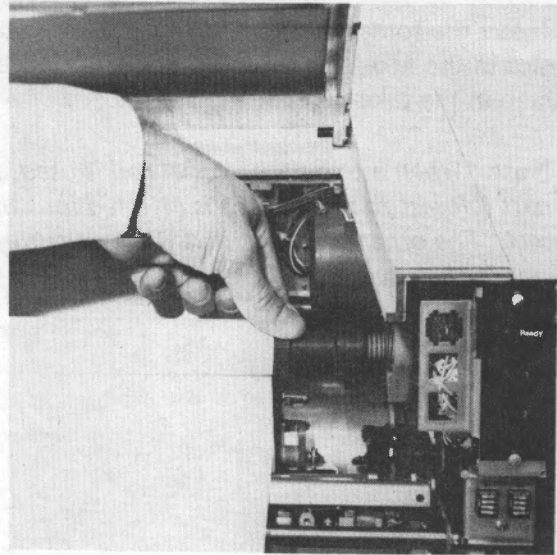


14. Wrap two or three turns of journal paper around the take-up reel.
15. Mount the take-up reel (right end in the spring-loaded Forms Advance Knob and the left end in the hole in the bracket).



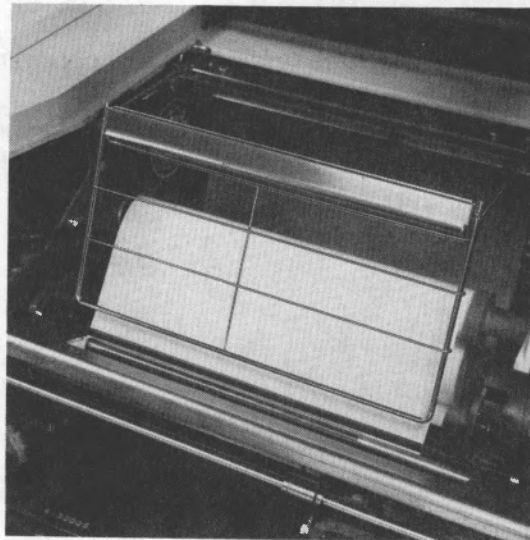
16. Turn the Forms Advance Knob to take up all of the slack.

**Note:** When a two-part journal roll is used, feed the first part up through the viewing window and out the serrated slot in the top cover.



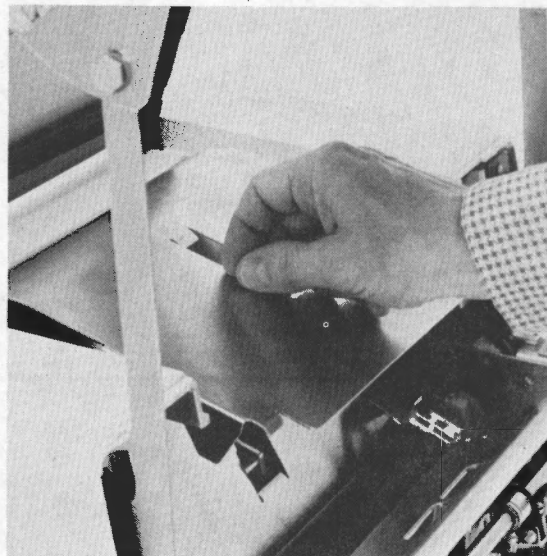
- 16a. If the unit has a paper guide, carefully lower it into place.

17. Release the support arm stops (see "Closing the Cover"), hold the cover with one hand, and grasp the end of the journal paper with the other hand. Close the cover while sliding excess paper out of the top of the cover.



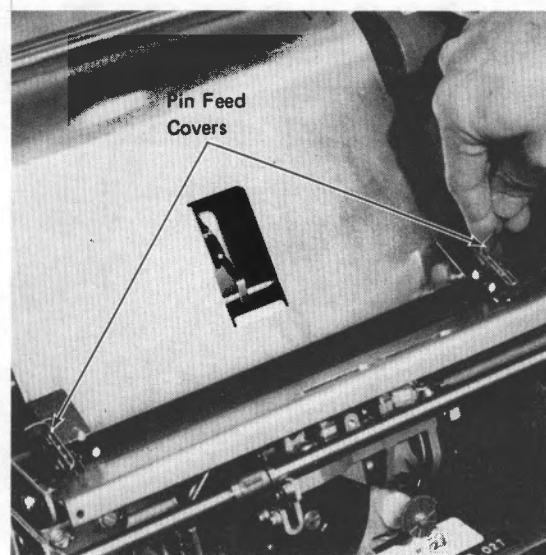
### Loading Continuous Forms

1. Press the STOP PRINT switch.
2. Open the cover (see "Opening the Cover").
3. Lift open the upper forms guide.

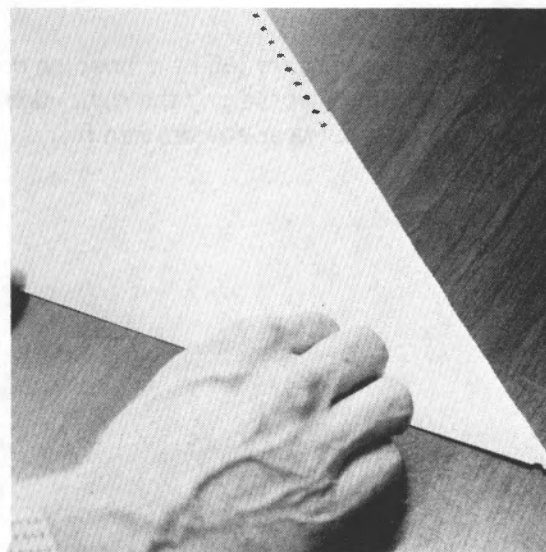




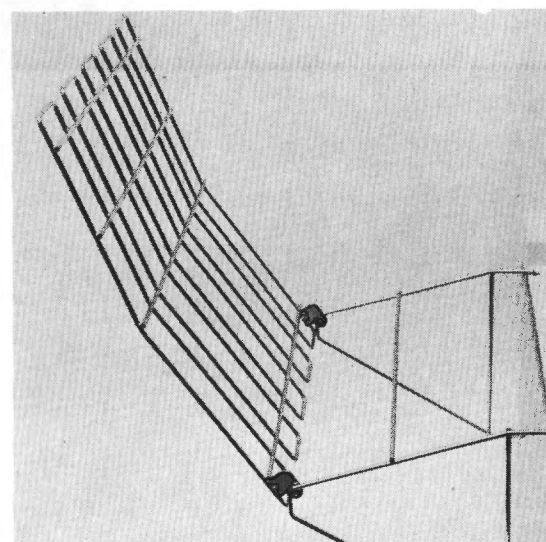
4. Open both pin feed covers by pushing down slightly on the top while pulling them open.



5. Crease the leading edge of the forms to form a point on the right side.

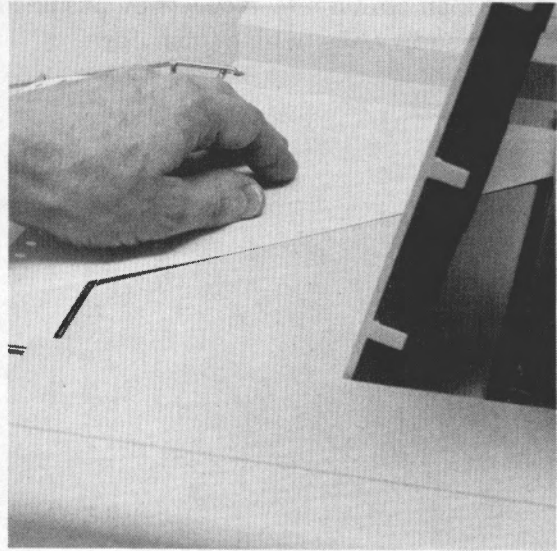


6. Raise the top of the forms rack.

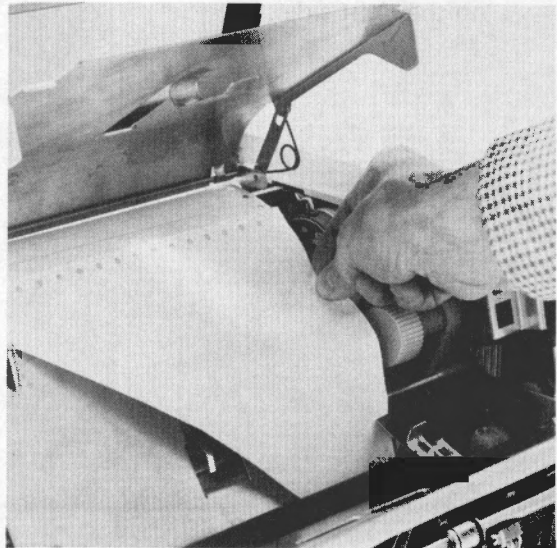




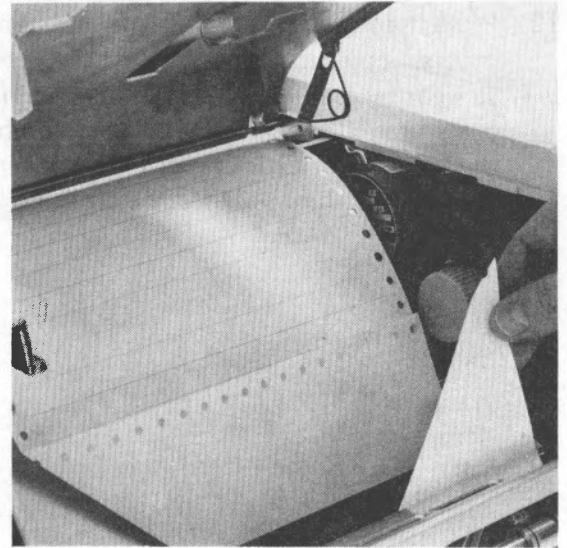
7. Feed the pointed edge of the forms over the guide bar on the forms rack and through the opening in the rear of the top cover.



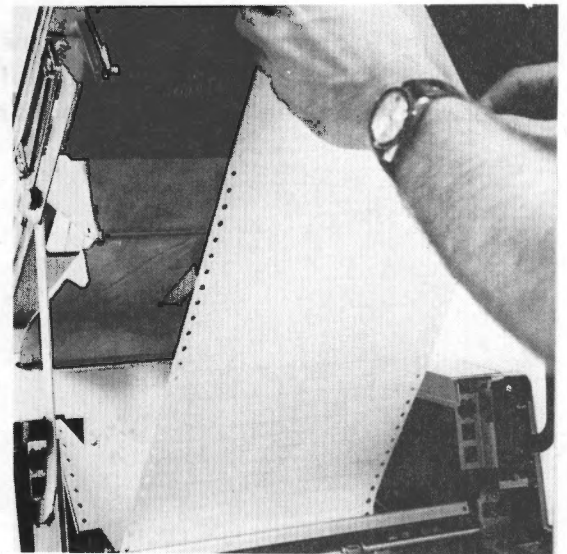
8. Feed the forms through the opening near the upper forms guide pivot, along the right edge of the platen, and down between the bottom forms guide and the platen.



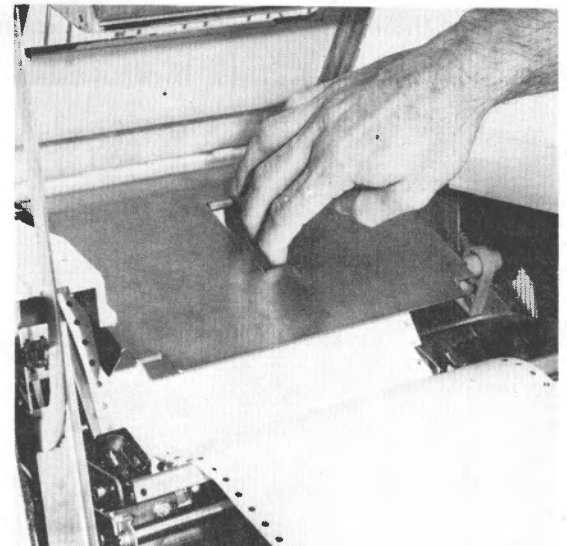
9. Push the forms down until they come into view in front of the platen at the right end. Keep the point next to the platen with your finger and continue pushing the forms down until they are completely around the platen and you are able to grasp the point from the top.



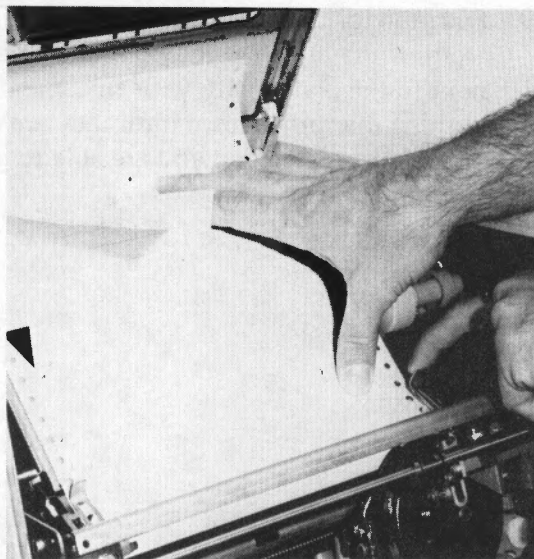
10. Pull the forms through until you have enough to exit *over the bar* in the rear of the top cover.



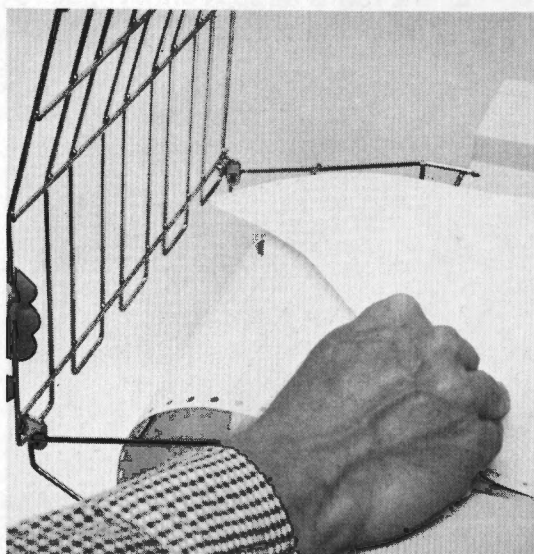
11. Close the upper forms guide.



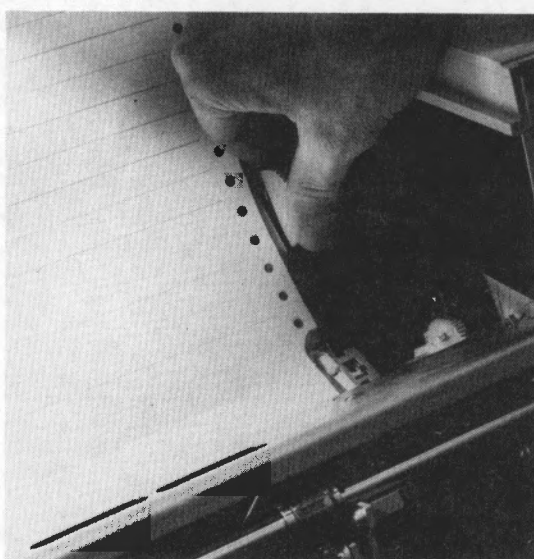
12. Place the forms on the pins and close both pin-feed covers. You can make sure that the forms are straight by making sure that the top pin on each side goes through the same relative hole on both sides of the forms. For example, put the top pin on each side through the third hole from the top on both sides of the form.



13. Feed the forms *over the bar* and out the slot in the back of the top cover. Hold the edge of the forms forward and close the top of the forms rack.

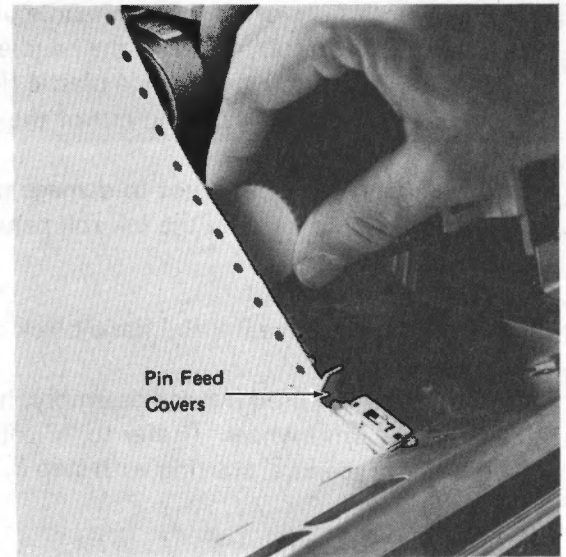


14. Turn the Forms Advance Knob to advance the paper to take up all slack.





15. Position the forms so that the first line printed will print on the correct line on the forms. In most cases, advance the forms until a perforation lines up with the "V" notches in the pin feed covers. The "V" notches are 1 inch (2.54 cm) above the line to be printed. Using these notches and the perforation as references, you can accurately position the paper for your first print line.
16. Release the support arm stops (see "Closing the Cover"), hold the cover with one hand, and grasp the end of the forms with the other hand. Close the cover while sliding excess paper out the rear of the cover.



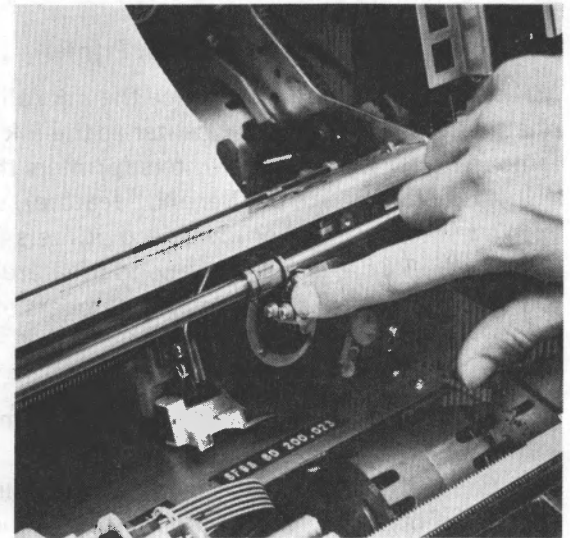
#### **Ink Roll Removal, Document Printer**

Replace the ink roll when printing becomes too light. To avoid getting ink on your fingers when handling ink rolls, be careful not to touch the ink roll itself. Always pick an ink roll up by its plastic handle.

1. Open the cover (see "Opening the Cover").

**CAUTION:** Be sure the print wheel has stopped turning before proceeding.

2. Push the document print unit all the way to the right.

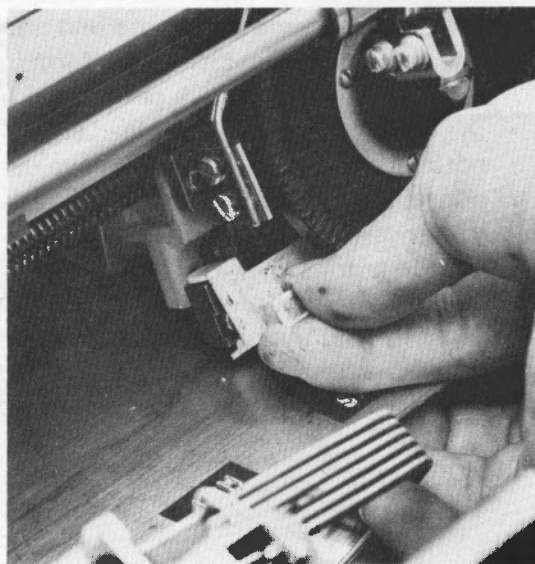




3. Grasp both sides of the plastic handle of the ink roll assembly. Carefully push on the handle towards the back of the printer to free one plastic finger. Then lift the ink roll assembly up and out of the printer.

**CAUTION:** Be careful not to damage the print wheel. Do not pull up hard on the ink roll behind the print wheel.

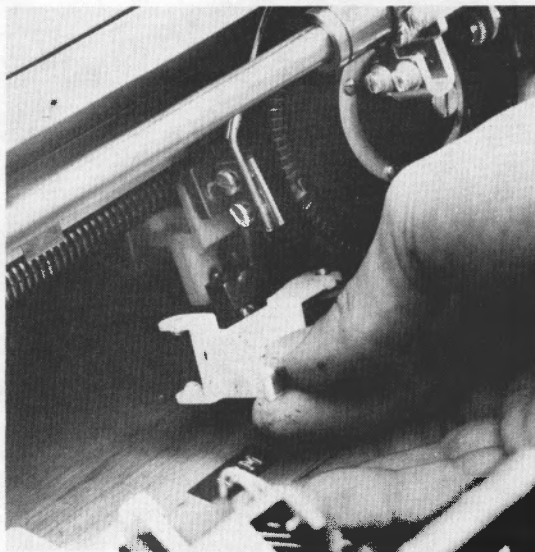
4. Check whether the ink roll has a black center or a white center.
5. Dispose of the used ink roll assembly, handle and all.
6. Clean the print wheel. (Refer to "Cleaning the Print Wheel" procedure, starting with step 3.)



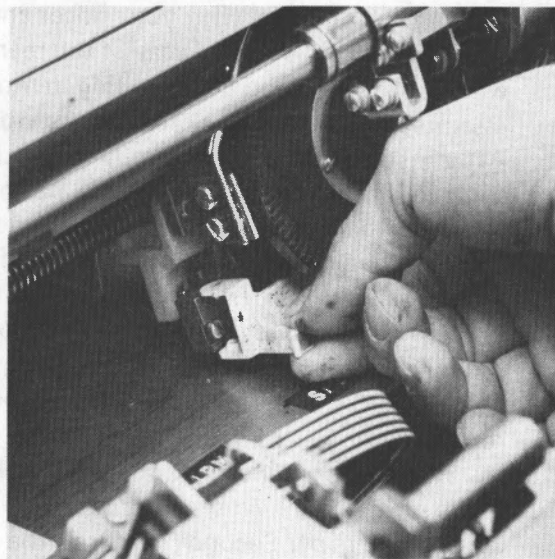
### **Ink Roll Replacement, Document Printer**

Make sure that when you replace the ink roll you install one that has the same color center as the ink roll you removed. For high-speed printers (printers that have the "Up to 30 Characters per Second" feature), use an ink roll with a white center. For low-speed printers (printers that have the "15 Characters per Second" feature), use an ink roll with a black center. The part numbers of the ink rolls are listed under "Installation Details."

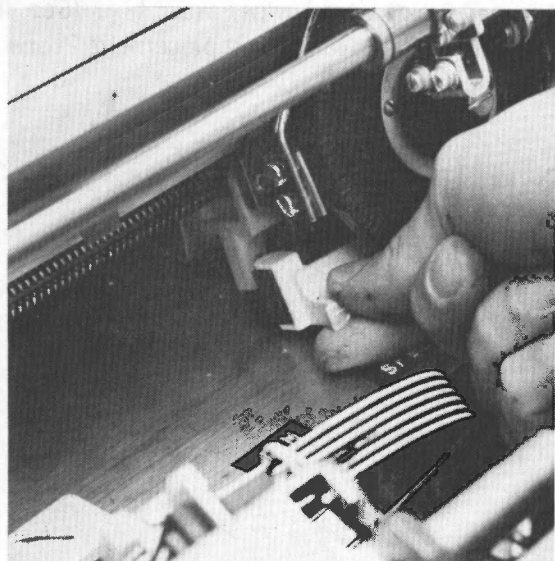
1. Remove the new ink roll assembly from its protective package.
2. Grasp the plastic handle and guide the ink roll assembly down and to the right until the ink roll is behind the print wheel.



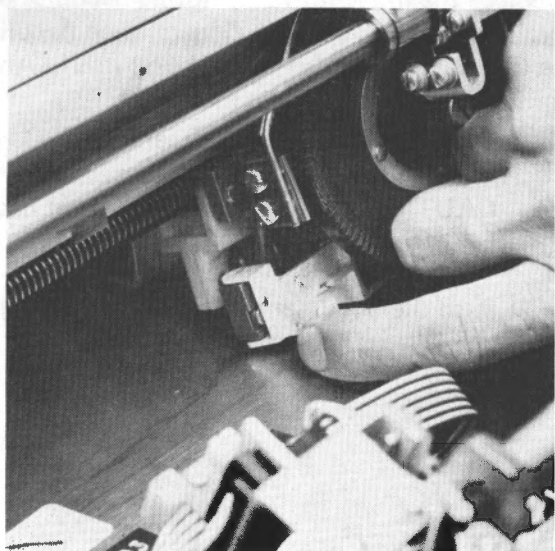
3. Place the plastic fingers directly over their notches on the mounting block.



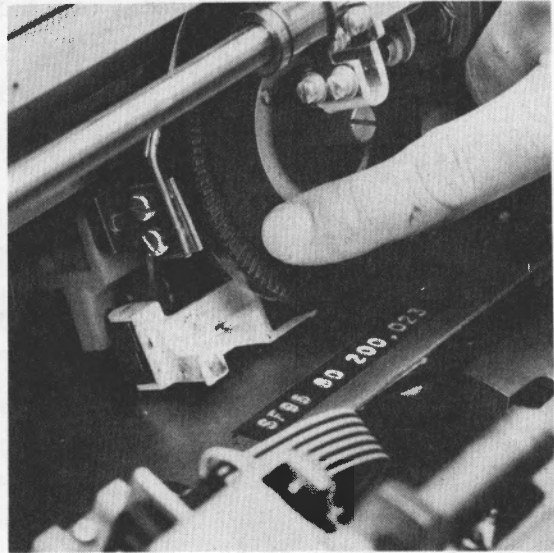
4. Push the ink roll handle down until the fingers snap onto the mounting block.



5. Push the handle of the ink roll assembly to the right, against the spring tension, several times (to test that the ink roll assembly is properly seated).



6. Turn the print wheel with your finger and make sure that the ink roll is rolling against the rear of the print wheel. If the ink roll is not rolling, remove the ink roll assembly and repeat this procedure starting from step 2.
7. After installing the new ink roll, print briefly on a test form to make sure that the ink roll has been correctly installed, that the print wheel is fairly clean, and that the print quality reaches a good level before restarting normal operations. To print, do the following steps.
8. Go to a 3604 and log on as the control operator.
9. Assign the printer using the 007 command.
10. Key in the 020 command and instruct the exerciser to run for a number of lines.
11. Insert a test form and press the START PRINT switch.
12. If the printer is a high-speed printer (it has the "Up to 30 Characters per Second" feature), the ink roll package has a print wheel wiper assembly. Put on this new print wheel wiper assembly. (See "Print Wheel Wiper Removal and Replacement Procedures.")



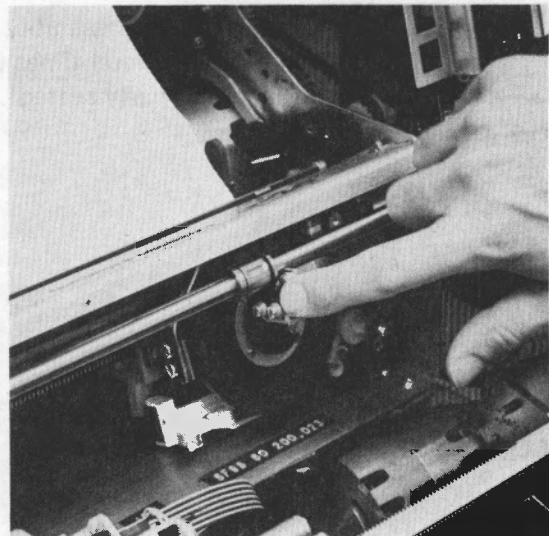
### Ink Roll Removal, Passbook Printer

Replace the ink roll when printing becomes too light. To avoid getting ink on your fingers when handling ink rolls, be careful not to touch the ink roll itself. Always pick an ink roll up by its plastic handle.

1. Open the cover. (See "Opening the Cover.")

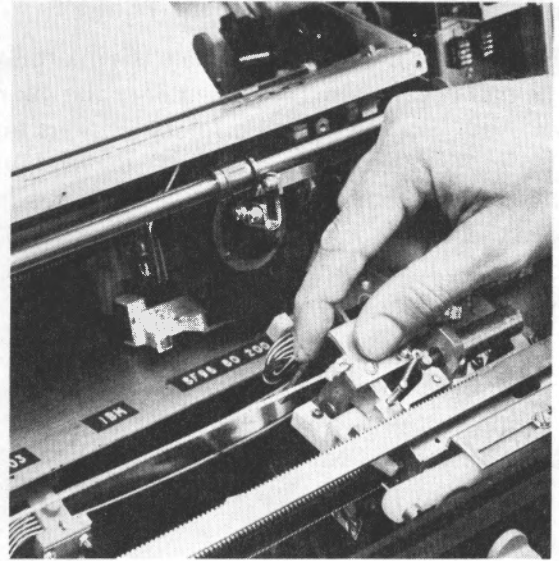
**CAUTION:** Be sure the print wheel has stopped turning before proceeding.

2. Push the document print unit all the way to the right.





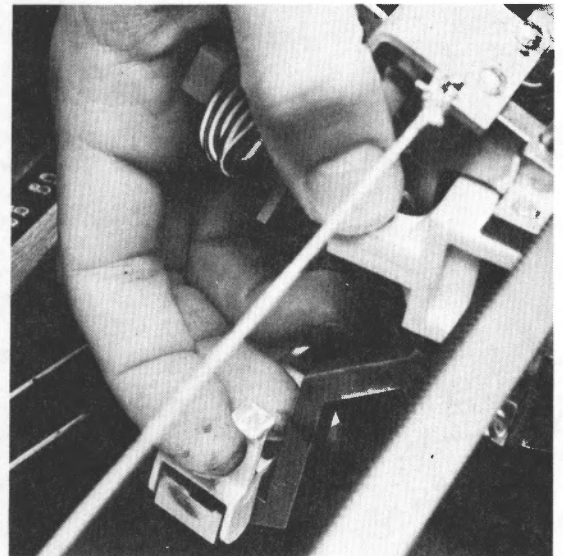
3. Push the passbook print unit all the way to the right.



4. Place your fingers on both sides of the plastic handle of the ink roll assembly and your thumb on a flat surface near the top of the print unit. Carefully pull upward until the plastic fingers snap free of the mounting block. Then lift the ink roll assembly up and out of the printer.

**CAUTION:** Be careful not to damage the print wheel. Do not pull up hard on the ink roll behind the print wheel.

5. Check whether the ink roll has a black center or a white center.
6. Dispose of the used ink roll assembly, handle and all.
7. Clean the print wheel. (Refer to "Cleaning the Print Wheel" procedure, starting with step 3.)

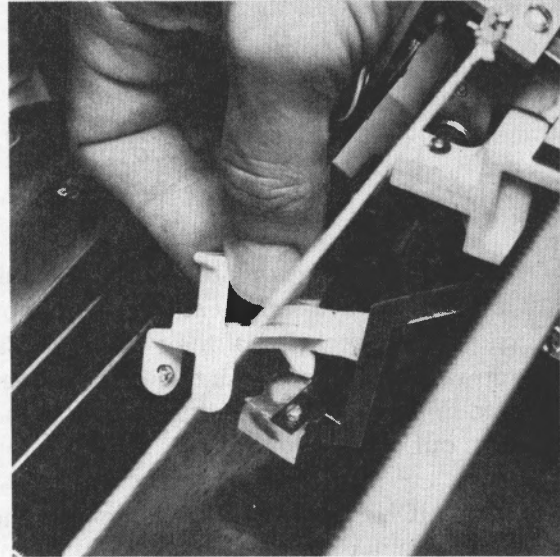




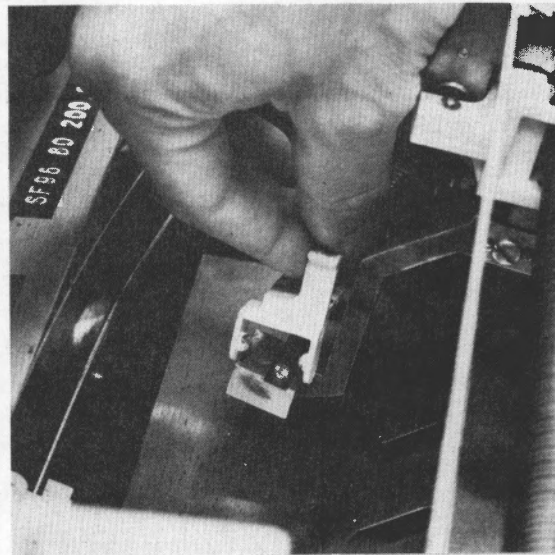
## Ink Roll Replacement, Passbook Printer

Make sure that when you replace the ink roll you install one that has the same color center as the ink roll you removed. For high-speed printers (printers that have the "Up to 30 Characters per Second" feature), use an ink roll with a white center. For low-speed printers (printers that have the "15 Characters per Second" feature), use an ink roll with a black center. The part numbers of the ink rolls are listed under "Installation Details."

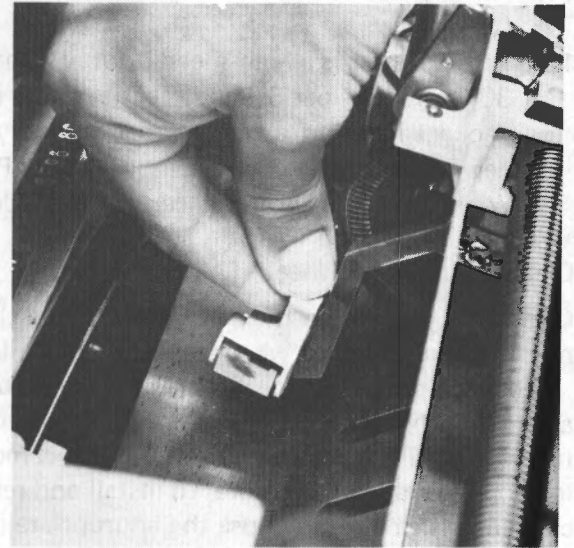
1. Remove the new ink roll assembly from its protective package.
2. Grasp the plastic handle and guide the ink roll assembly down and to the right until the ink roll is behind the print wheel.



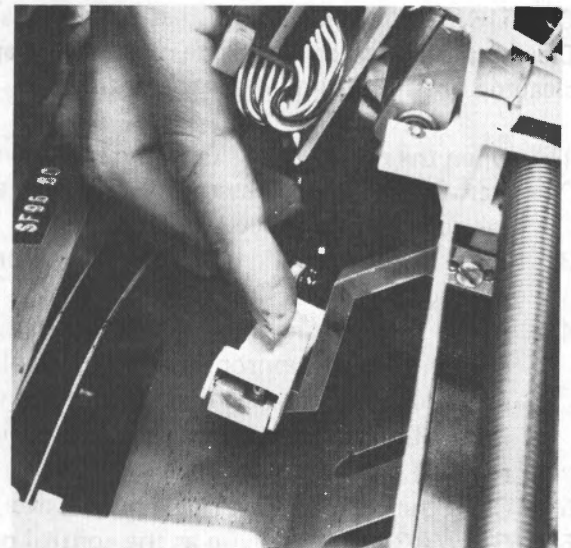
3. Place the plastic fingers directly over their notches on the mounting block.



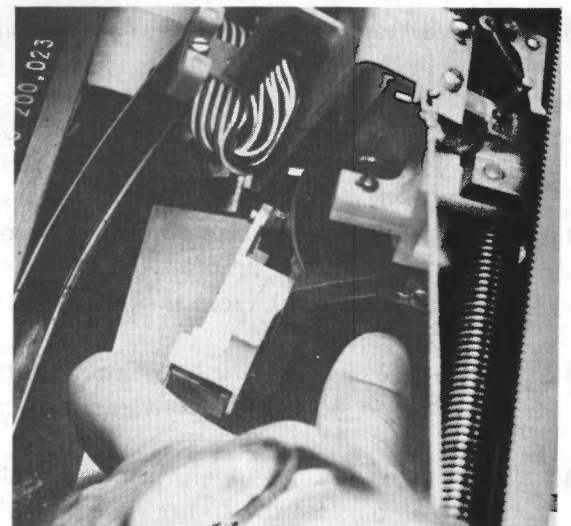
4. Push the ink roll handle down until the fingers snap onto the mounting block.



5. Push the handle of the ink roll assembly to the right, against the spring tension, several times (to test that the ink roll assembly is properly seated).



6. Turn the print wheel with your thumb and make sure that the ink roll is rolling against the rear of the print wheel. If the ink roll is not rolling, remove the ink roll assembly and repeat this procedure starting from step 2.
7. After installing the new ink roll, print briefly on a test passbook to make sure that the ink roll has been correctly installed, that the print wheel is fairly clean, and that the print quality reaches a good level before restarting normal operation. To print, do the following steps:
8. Go to a 3604 and log on as the control operator.
9. Assign the printer using the 007 command.
10. Key in the 020 command and instruct the exerciser to run for a number of lines.



11. Insert a test passbook and press the **START PRINT** switch.
12. If the printer is a high-speed printer (it has the "Up to 30 Characters per Second" feature), the ink roll package has a print wheel wiper assembly. Put on this new print wheel wiper assembly. (See "Print Wheel Wiper Removal and Replacement Procedures.")

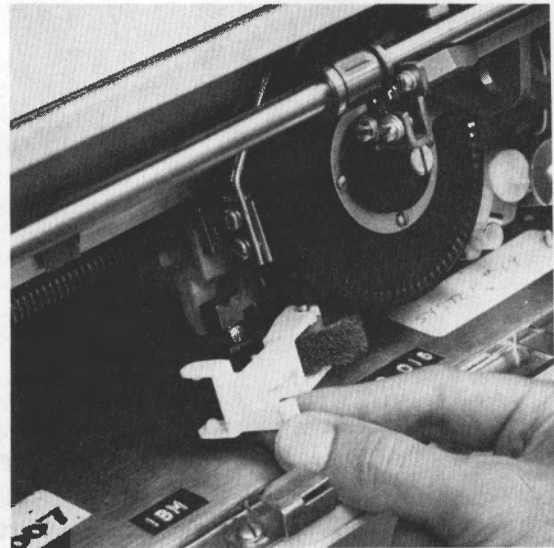
### **Cleaning the Print Wheel**

Clean the typeface on the print wheel when characters are not printing clearly or whenever you replace the ink roll.

To clean the print wheel, use the cleaning brush assembly (PN 1811470). It fits on the ink roll mounting block and is installed and removed in the same way as the ink roll assembly. Therefore, to install and remove the cleaning brush assembly, use the appropriate ink roll removal and ink roll replacement procedures.

**CAUTION: The cleaning brush assembly must be used dry. Cleaning fluid, solvent, or paste must not be applied to the cleaning brush or print wheel at any time.**

1. Open the cover. (See "Opening the Cover.")
2. Remove the ink roll assembly. (See the appropriate ink roll removal procedure.)
3. Remove the cleaning brush assembly from its protective package.
4. Install the cleaning brush assembly. See adjacent photo. (See the appropriate ink roll replacement procedure.) If the cleaning brush is not rolling after installation, remove it using the appropriate ink roll removal procedure and repeat step 4.
5. Close the cover. (See "Closing the Cover".)
6. Go to a 3604 and log on as the control operator.
7. Assign the printer using the 007 command.
8. Key in the 066 command.
9. Insert a "test passbook" if you are cleaning the print wheel in the passbook printer.
10. Press the **START PRINT** switch if printing does not begin. (Printing will stop after 20 lines or when the end of the passbook page or form is reached, whichever comes first, or if an error occurs.)
11. When printing stops, open the cover, remove the cleaning brush assembly (see the appropriate ink roll removal procedure), close the cover, and key in the 066 command.
12. Return the cleaning brush assembly to its protective package and store it in a convenient place for future use.
13. When printing stops, open the cover, install the ink roll assembly (see the appropriate ink roll replacement procedure) and close the cover.



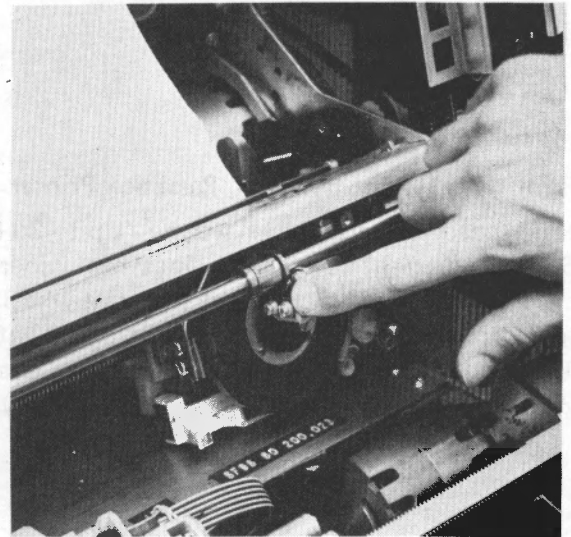


14. Check the printed characters. If any character is not printing fully and clearly, repeat this print wheel cleaning procedure from the beginning.
15. If the printing appears light, repeat steps 8, 9, and 10 until the printing is acceptable.

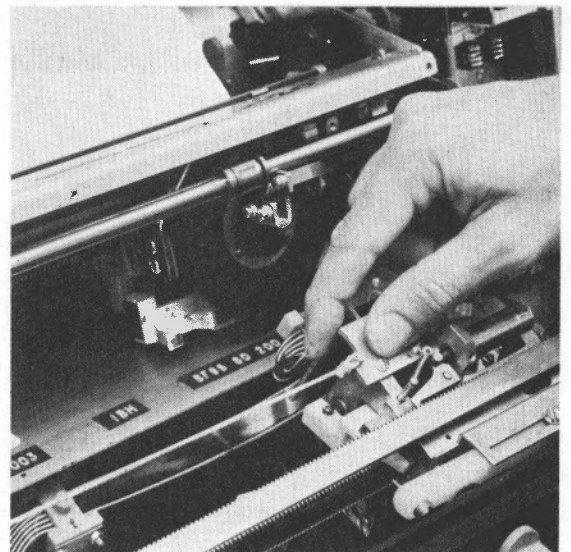
#### **Print Wheel Wiper Removal, Document Printer**

High-speed printers (they have the "Up to 30 Characters per Second" feature) have a felt print wheel wiper to wipe excessive ink from the edge of the print wheel. It must be replaced when it gets full of ink or clogged with paper dust.

1. Open the cover. (See "Opening the Cover.")
2. Push the document print unit all the way to the right.



3. Push the passbook print unit all the way to the right.

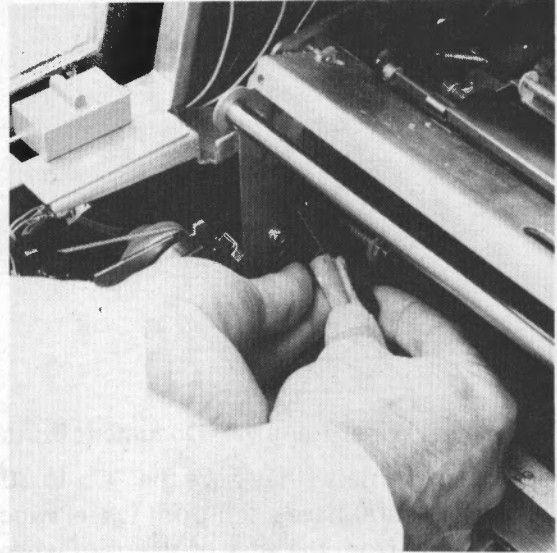




4. With your left hand, hold the spring bracket. With your right, pull the wiper holder until it snaps loose from the spring bracket.
5. Dispose of the old wiper assembly.

#### **Print Wheel Wiper Replacement, Document Printer**

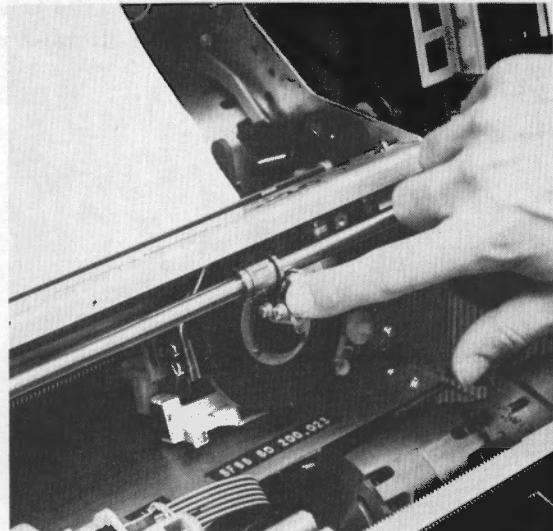
1. Remove the new wiper assembly from its protective package.
2. Place your left thumb behind the plastic mounting block to hold the spring bracket and to provide support for the mounting block. Hold the wiper with your right hand so that the holes in the felt wiper assembly are at the front and push the felt wiper assembly up from the bottom until it snaps into place on the plastic mounting block.



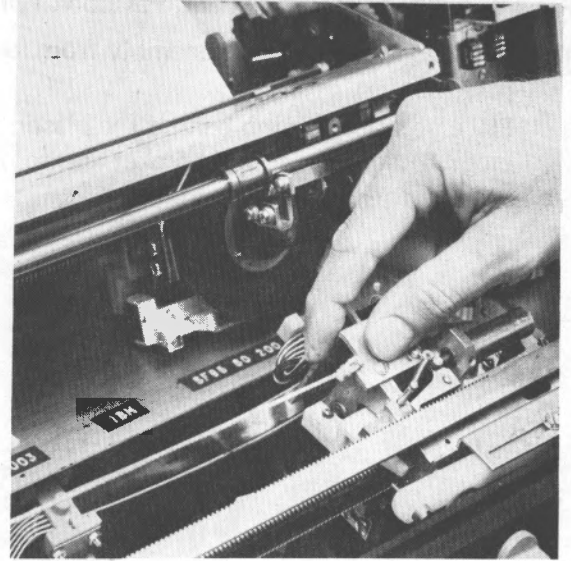
#### **Print Wheel Wiper Removal, Passbook Printer**

High-speed printers (they have the "Up to 30 Characters per Second" feature) have a felt print wheel wiper to wipe excessive ink from the edge of the print wheel. It must be replaced when it gets full of ink or clogged with paper dust.

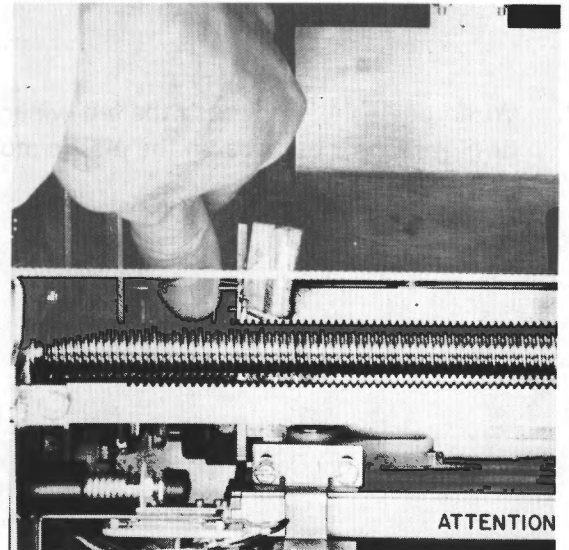
1. Open the cover. (See "Opening the Cover.")
2. Push the document print unit all the way to the right.



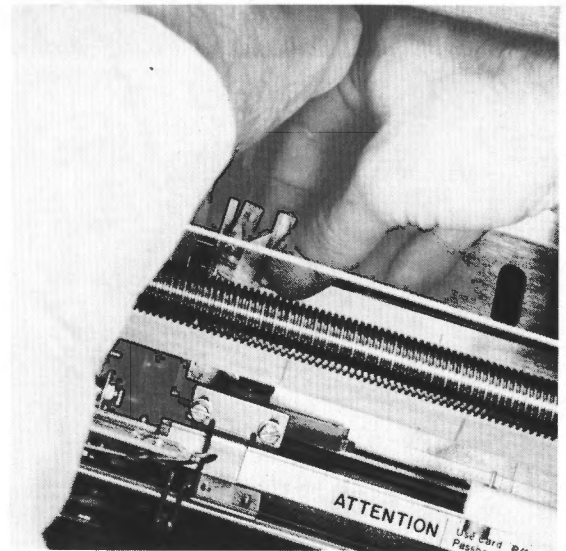
3. Push the passbook print unit all the way to the right.



4. Hold the spring bracket with your left thumb.

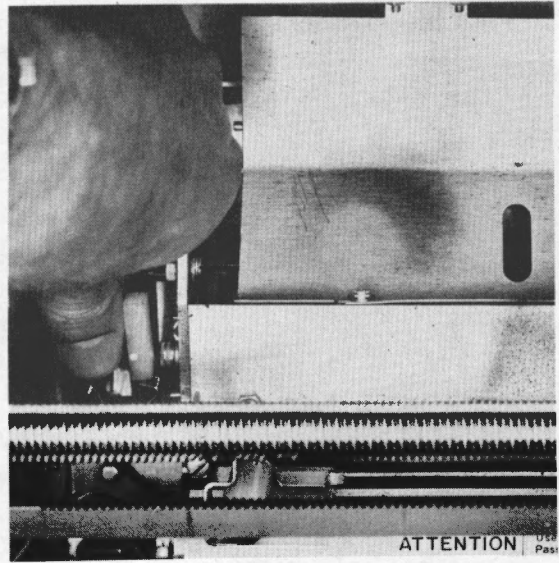


5. With your right hand, pull the wiper holder until it snaps loose from the spring bracket.
6. Dispose of the old wiper assembly.

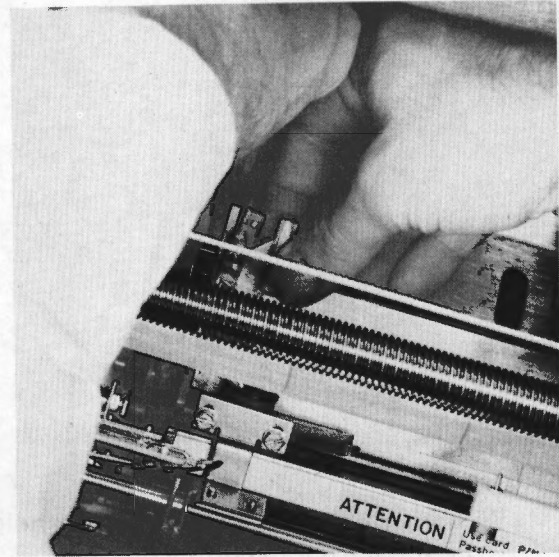


### Print Wheel Wiper Replacement, Passbook Printer

1. Remove the new wiper assembly from its protective package.
2. Place your left thumb behind the plastic mounting block to hold the spring bracket and to provide support for the mounting block.



3. With your right hand, push the felt wiper assembly until it snaps into place on the plastic mounting block.



## Contents – 3618 Administrative Line Printer

|   |    |
|---|----|
| Operating Controls and Lights .....                               | 1  |
| ON/OFF Switch .....   | 1  |
| START PRINT and STOP PRINT Switches .....                         | 1  |
| READY Light .....   | 2  |
| 1 and 2 Lights .....  | 2  |
| Print Unit Release Lever .....                                    | 2  |
| Forms Tractor Release Levers .....                                | 2  |
| Upper Forms Guide Latch .....                                     | 4  |
| Forms Advance Knobs and Vernier .....                             | 4  |
| Print Position Scale .....  | 5  |
| Forms Alignment Scales .....                                      | 5  |
| Forms Chute Guides .....  | 5  |
| End of Forms Control .....  | 6  |
| Print Line Indicator .....  | 6  |
| Forms Thickness Control .....                                     | 6  |
| Ribbon Drive Release Lever .....                                  | 7  |
| Print Belt Release Lever .....                                    | 7  |
| Dual Independent Forms Feed .....                                 | 7  |
| Forms Tractors and Release Levers .....                           | 9  |
| Forms Advance Knobs and Verniers .....                            | 9  |
| End of Forms 1 and 2 Controls .....                               | 9  |
| Supplies .....  | 9  |
| Cleaning Procedures .....   | 9  |
| Operating Procedures .....  | 10 |
| Opening the Cover .....   | 10 |
| Closing the Cover .....   | 11 |
| Loading Forms, Single-Carriage Printer .....                      | 11 |
| Aligning Forms to First Print Line, Single-Carriage Printer ..... | 14 |
| Loading Forms, Two-Carriage Printer .....                         | 15 |
| Aligning Forms to First Print Line, Two-Carriage Printer .....    | 18 |
| Removing Forms .....  | 20 |
| Ribbon Cassette Removal .....                                     | 20 |
| Ribbon Cassette Replacement .....                                 | 22 |
| Print Belt Removal .....  | 23 |
| Print Belt Replacement .....                                      | 24 |

This page precedes the Unit Operating Procedures, 3618 Administrative Line Printer page 1.



1. The information contained in this document is classified as CONFIDENTIAL - SECURITY INFORMATION.

2. This information is intended for the use of authorized personnel only.

3. It is to be controlled, stored, and transmitted in accordance with applicable security policies.

4. Any unauthorized disclosure of this information is prohibited.

5. This document is to be destroyed when it is no longer needed.

6. The information contained herein is the property of the United States Government.

7. It is to be controlled, stored, and transmitted in accordance with applicable security policies.

8. Any unauthorized disclosure of this information is prohibited.

9. This document is to be destroyed when it is no longer needed.

10. The information contained herein is the property of the United States Government.

11. It is to be controlled, stored, and transmitted in accordance with applicable security policies.

12. Any unauthorized disclosure of this information is prohibited.

13. This document is to be destroyed when it is no longer needed.

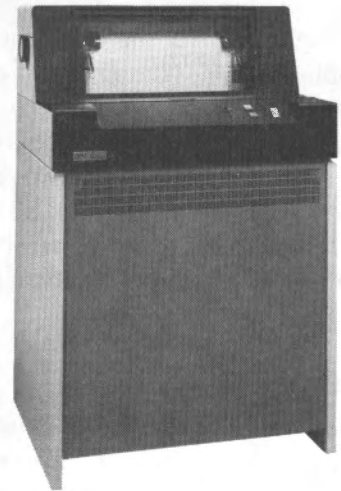
14. The information contained herein is the property of the United States Government.

15. It is to be controlled, stored, and transmitted in accordance with applicable security policies.

16. Any unauthorized disclosure of this information is prohibited.

## IBM 3618 Administrative Line Printer

The 3618 printer can print up to 80 or 132 characters per line on continuous forms and provide up to six copies. The 3618 prints much faster than the other 3600 printers and is generally used for your institution's lengthier printing jobs. For a description of the 3618 Administrative Line Printer, refer to *Introducing the IBM 3600 Finance Communication System*, GA27-2764.



### OPERATING CONTROLS AND LIGHTS

#### ON/OFF Switch

Press ON of the ON/OFF switch to apply power to your 3618. When you want to turn off the 3618, simply press OFF.

**CAUTION:** Pressing the ON/OFF switch to ON or OFF may cause errors on other terminals if they are in use on the same loop.

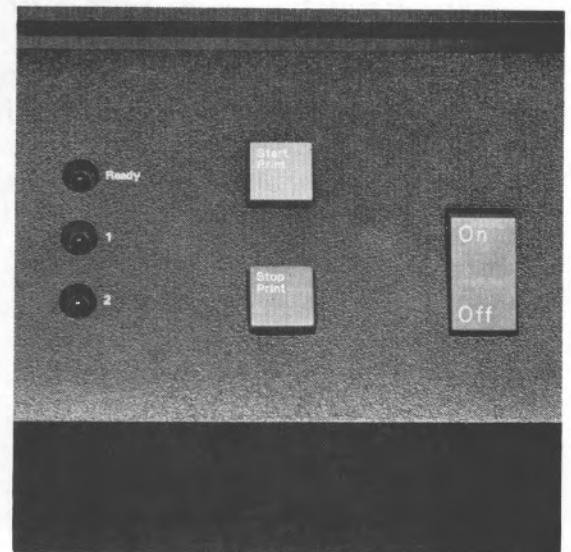
Turning the power off, in addition to conserving energy, activates a bypass circuit that functionally removes the unit from the loop without disconnecting the cables. This circuit provides a simple and rapid means to restore the loop operation if the terminal should malfunction.

There is, however, a possible loop cable length problem between the units with power on; for details, refer to the *IBM 3600 Finance Communication System Configurator*, GA27-2762.

#### START PRINT and STOP PRINT Switches

Press the START PRINT switch when you want to start printing. Pressing this switch tells the controller that the 3618 is ready for the printing operation to start. Make sure there is paper in the printer before pressing this switch.

Press the STOP PRINT switch to stop any printing that is in progress on the 3618.



## READY Light

The condition of the READY light tells you the status of the communications between the 3618 and the controller. When the light is on all the time, there are no communications problems. This is the normal operating state. If the light is *off* all the time or *flashing* on and off, it indicates that a communications problem exists between the 3618 and the controller. When it's *always off*, signals from the controller are not arriving at the 3618. When it's *flashing on and off*, signals from the controller are arriving at the 3618 but signals from the 3618 are not reaching the controller.

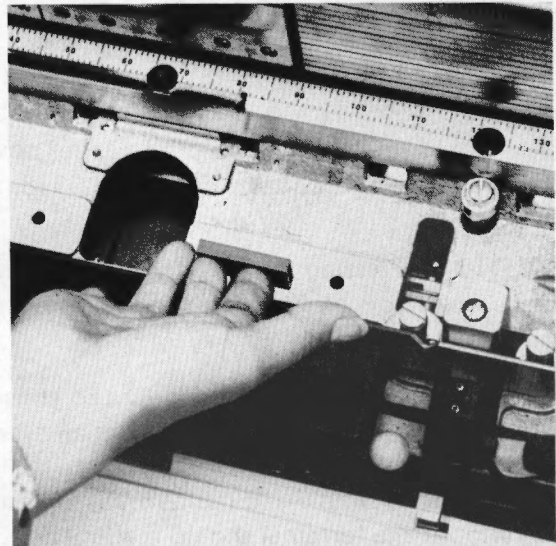
## 1 and 2 Lights

The name and function of the 1 and 2 lights are determined by your institution. Refer to the description of these lights provided by your institution; it should be placed in this chapter of the operating guide.

## Print Unit Release Lever

The print unit must be opened to load or remove forms, replace the ribbon, or change the print belt. Pull this lever toward the front of the printer to open the print unit; push it toward the rear to close the print unit.

**Note:** *When the print unit is open, the print belt does not run.*

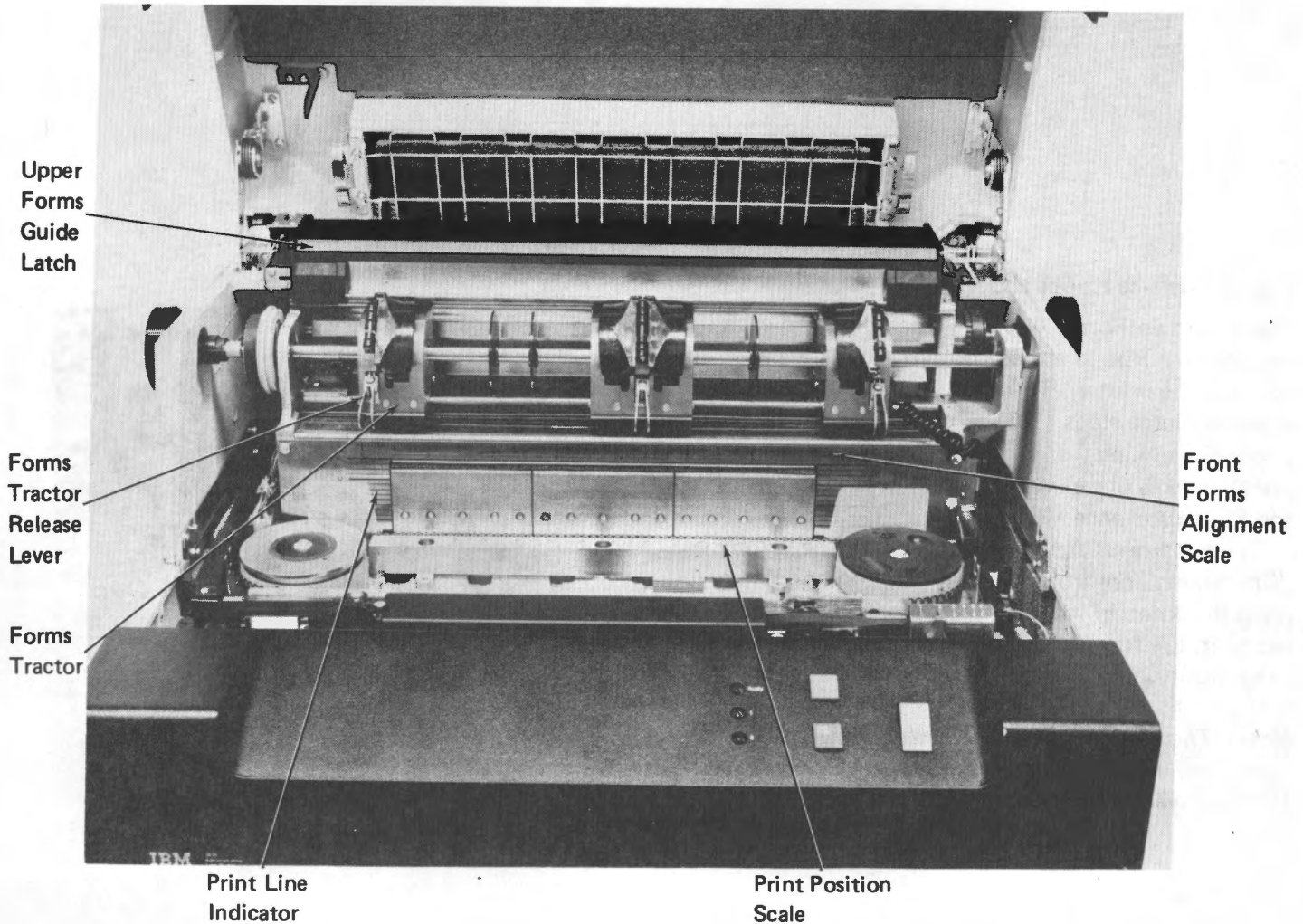


## Forms Tractor Release Levers

"Forms tractor" is the name given to the part of the paper feed mechanism that moves the forms a line at a time while printing is taking place. See the figure on the next page. There are two forms tractors associated with each form, one on each side. The pins on the forms tractors fit through the holes along each edge of the forms. The pins move upwards along the path of the forms under control of the printer. In this way the forms tractors pull the forms up through the printer. The tractor covers hold the holes in the forms to the tractor pins.

The forms tractors can be moved left or right to fit different width forms. This permits your institution to choose forms of different sizes, depending on its needs. When loading forms into the printer, you must set the forms

tractors to the width of the forms. To move the forms tractors, squeeze the Forms Tractors Release Levers together to loosen the forms tractors on their mounting. You can now slide the forms tractors left or right to the desired position. Release the levers to lock the forms tractors in place.



**Front View with Cover Open**



### Upper Forms Guide Latch

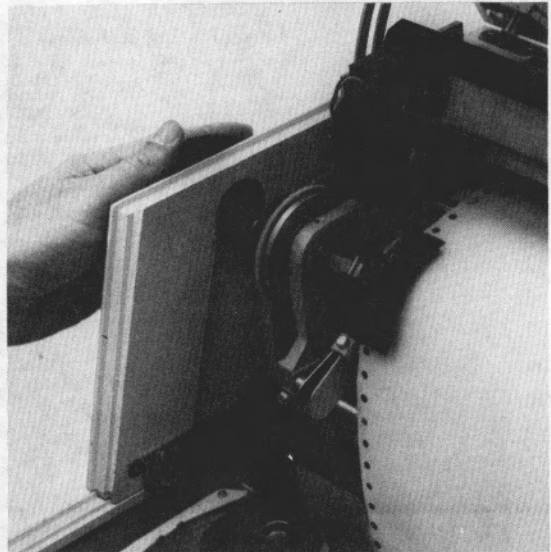
The upper forms guide directs the forms through the printer. To release the guide, press this latch (shown in the figure) to the rear; the guide will open automatically.

### Forms Advance Knobs and Vernier

There are two Forms Advance Knobs, one on each side of the printer. Rotate either knob to move the paper up through the printer. These knobs move the paper in relatively large steps [1/6 inch (4.23 mm)]. For more exact paper positioning (for example, adjusting the paper so that printing takes place on a specific line on the forms), use the Forms Advance Vernier.

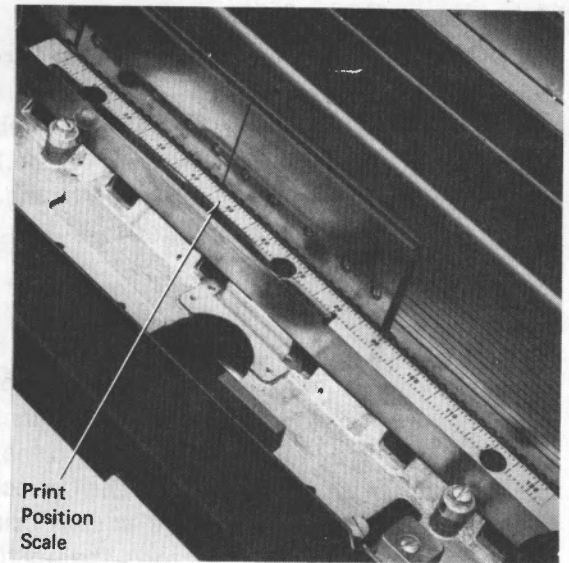
The left Forms Advance Knob is also the vernier or "fine tuning" control for forms positioning. When you press this knob in toward the printer, hold it there, and rotate it, the forms move in very small increments to allow exact positioning.

**Note:** *The stopping position of the forms tractors is controlled electrically; therefore if printer power is off, the Forms Advance Knobs and tractors move freely.*



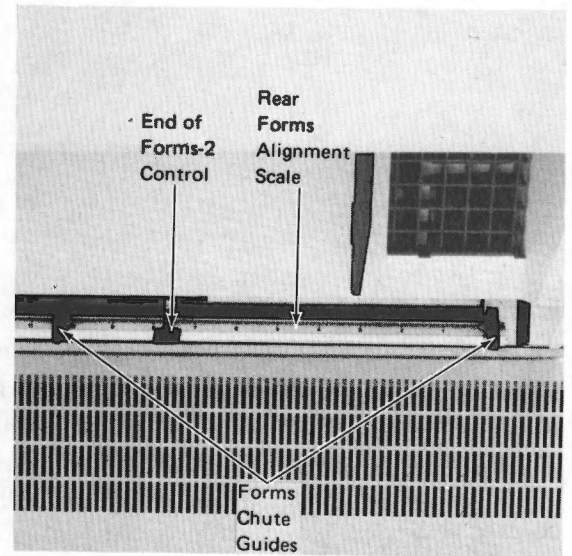
### Print Position Scale

The 3618 can print up to 80 or 132 characters on any one line. The Print Position Scale, located on the platen, shows you the position where each of those characters will print. When loading forms into the printer, use this scale to align the forms to the print positions. For example, if your institution chooses to begin printing all lines at print position 10, align the leftmost printing position on the forms with that print position on the scale.



### Forms Alignment Scales

There are two Forms Alignment Scales on the 3618. The front scale is located just below the forms tractors; the rear scale is located in the forms chute at the rear of the printer. Align the edge of the form to the same position on the two scales to get proper forms alignment in the printer.



### Forms Chute Guides

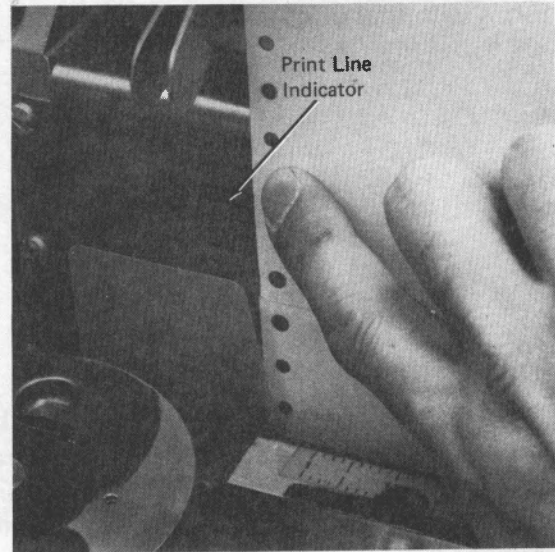
The forms chute is the forms entry point at the rear of the printer. The rear Forms Alignment Scale (discussed above) and the Forms Chute Guides are part of the forms chute. Move the Forms Chute Guides in towards the forms to keep the forms in alignment.

### End of Forms Control

The End of Forms control, located in the forms chute, senses the presence of forms in the forms chute. (The position of this control is indicated by a small arrow on the right end of the rear Forms Alignment Scale.) During printing, this control indicates that the end of the last form is within 8.5 inches (21.6 cm) of the print line.

### Print Line Indicator

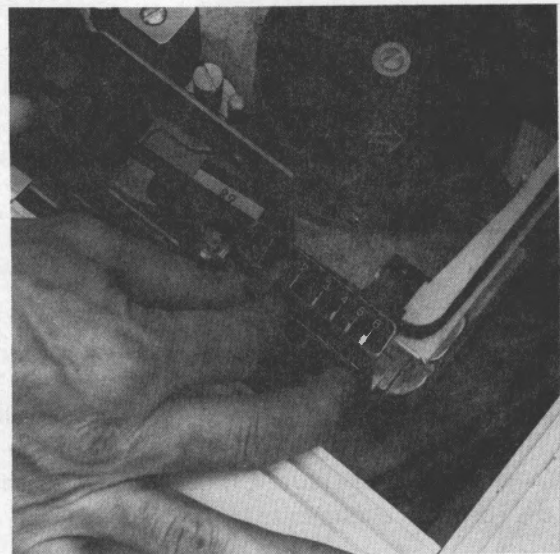
The Print Line Indicator is used to align the forms to the first line to be printed. The numbers next to the lines on the print line indicator represent the first 16 lines below the top of a form. You use them to position the forms so that the 3618 will print its first line on the correct line on your forms. For example, if you want to start printing on the fourth line below the top of a form (below the perforation), move the forms so the perforation lines up with "4" on the Print Line Indicator.



### Forms Thickness Control

The Forms Thickness control adjusts the printer to handle one-part to six-part forms\*. To get the best print quality and forms feeding and to extend the life of the ribbon, set the control to the position corresponding to the forms being used. For instance, to handle three-part forms, set the control to 3.

**CAUTION:** Operating the printer with the Forms Thickness control set incorrectly may result in poor printing and decreased ribbon life.

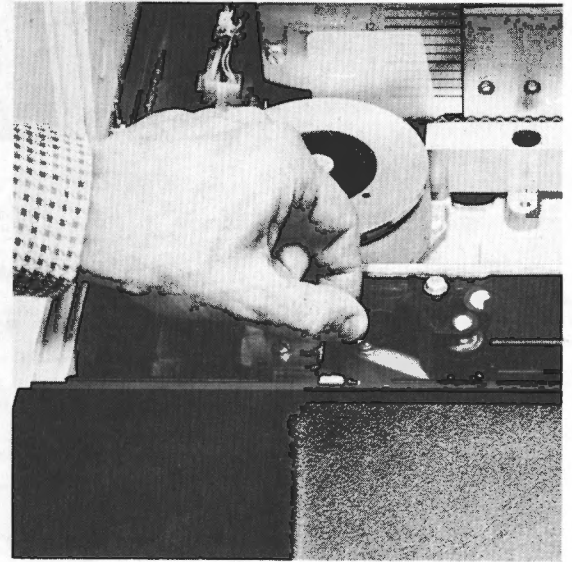


\*When printer forms are made up of multiple sheets (an original and one or more copies), they are referred to as "two, three, etc. part forms." For example, forms with one original and two carbon copies are three-part forms.



### Ribbon Drive Release Lever

Push this lever to the rear to release the pressure on the ribbon so that you can remove or replace the ribbon cassette.



### Print Belt Release Lever

Pull this lever toward the front of the printer to release the tension on the print belt so that you can remove or replace the print belt.



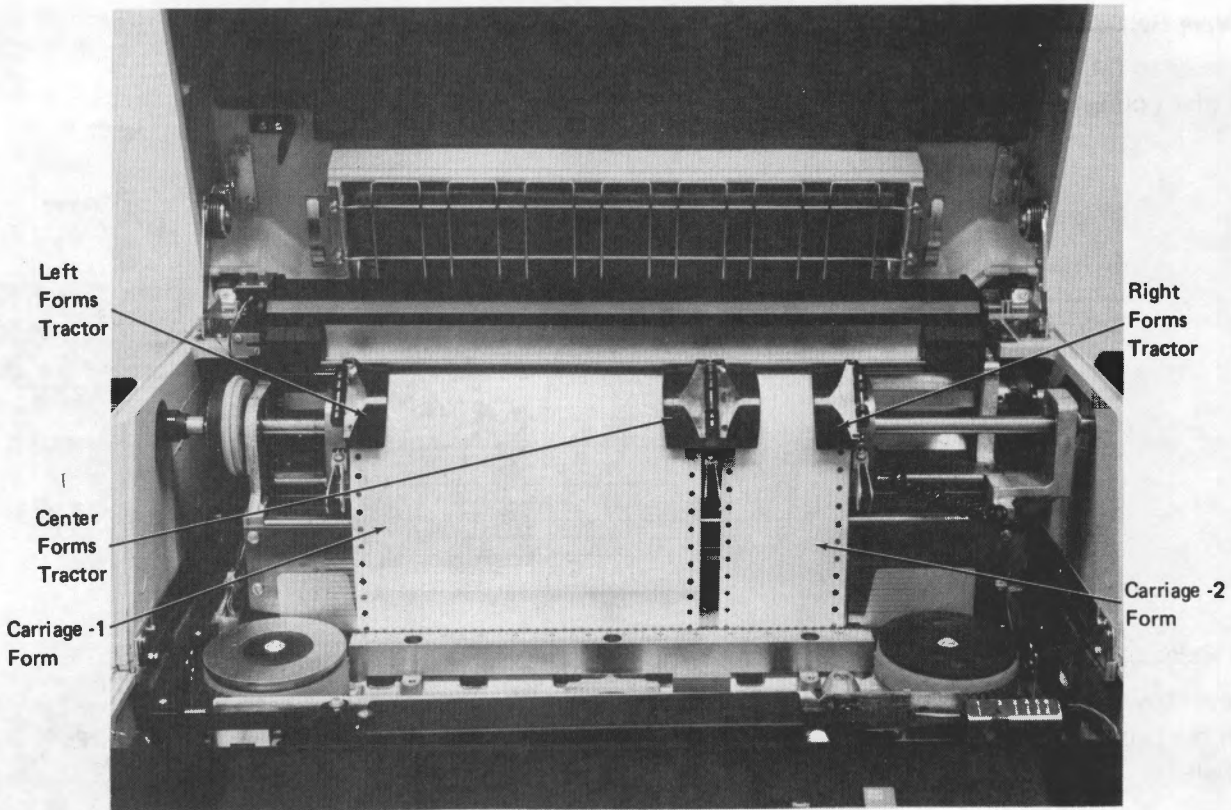
### Dual Independent Forms Feed

Your institution may have a 3618 with the Dual Independent Forms feature. This feature allows the 3618 to handle two continuous forms at the same time. The forms may have different widths. Thus the 3618 can print two different reports on two different width forms at the same time.

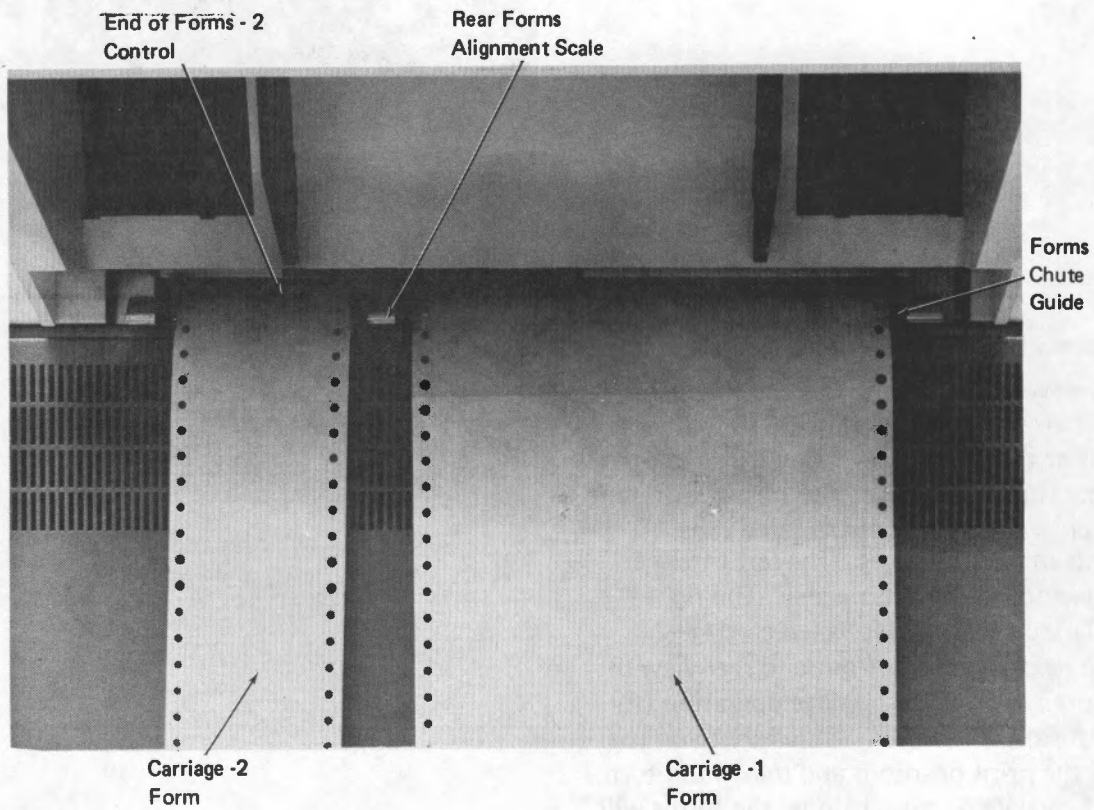
This feature consists of two carriages. The left carriage is the primary carriage and is called carriage-1. The right carriage is the secondary carriage and is called carriage-2. (See the figure on the next page for a front and rear view of a 3618 with this feature.) For single-carriage operation (for printing on only one form), it is recommended that you use carriage-1 because all the print positions and maximum-forms width can be used. If carriage-2 is used alone, the forms will not line up behind print positions 1 through 36.

The following paragraphs discuss the special controls provided with the Dual Independent Forms feature.





A. Front View with Cover Open



B. Rear View

**Two-Carriage Printer**

### **Forms Tractors and Release Levers**

Three forms tractors are used to feed the two forms. The center tractor has two individual tractors that feed the inner margins of the two forms. The left and center forms tractors feed the left form (carriage-1). The center and right forms tractors feed the right form (carriage-2).

To move the forms tractors, squeeze the Forms Tractors Release Levers together to loosen the forms tractors on their mounting. You can now slide the forms tractors left or right to the desired position. Release the levers to lock the forms tractors in place.

### **Forms Advance Knobs and Verniers**

Each carriage has one Forms Advance Knob with a vernier. Rotate the left knob to move the left form (carriage-1) in relatively large steps [1/6 inch (4.23 mm)]. To obtain fine adjustment of the left form, press in on the left knob, hold it there, and rotate it. The right knob is used in the same manner to advance the right form (carriage-2).

**Note:** *The stopping position of the forms tractors is controlled electrically; therefore if printer power is off, the Forms Advance Knobs and tractors move freely.*

### **End of Forms 1 and 2 Controls**

The operation of the End of Forms -1 control for the left form (carriage-1) is the same as for the single carriage printer.

The End of Forms-2 control for the right form (carriage-2) must be moved into one of four notches, depending on the width of the form. It indicates:

1. The end of the last form in carriage-2 is within 8.5 inches (21.6 cm) of the print line, or,
2. It is not set properly in one of the four notches.

### **SUPPLIES**

Supplies for the 3618 are listed under "Installation Details."

### **CLEANING PROCEDURES**

To clean the viewing window and the covers, use warm water and a mild detergent.

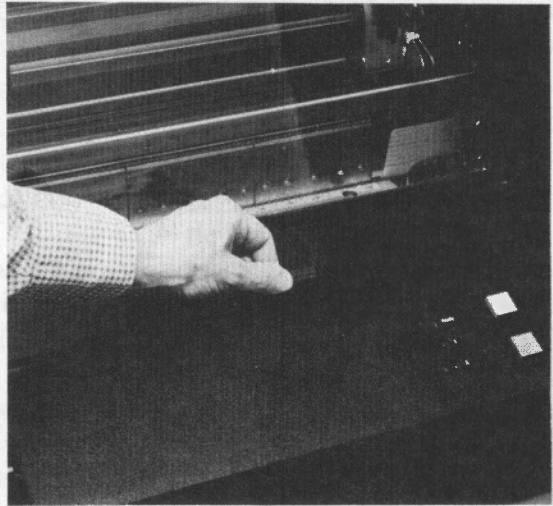
## OPERATING PROCEDURES

### Opening the Cover

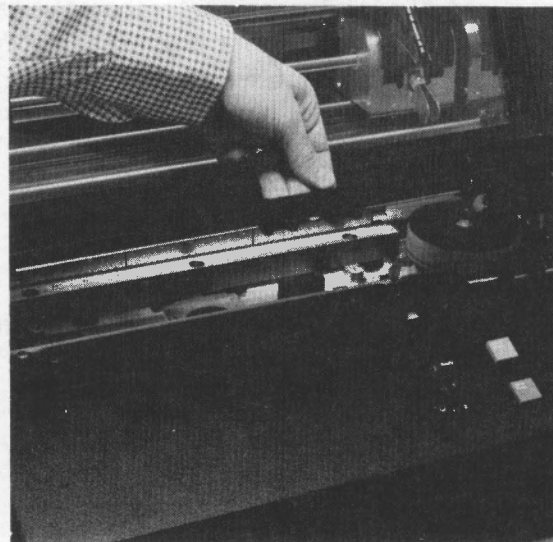
The 3618 cover must be opened to do all of the procedures that follow.

**Note:** *There is an interlock to disable the 3618 when the cover is open.*

1. Press down on the latch handle to unlatch the cover.



2. Insert your fingers under the latch handle and lift the cover to its fully open position. The cover will stay in an open position and must be closed manually. (See "Closing the Cover.")

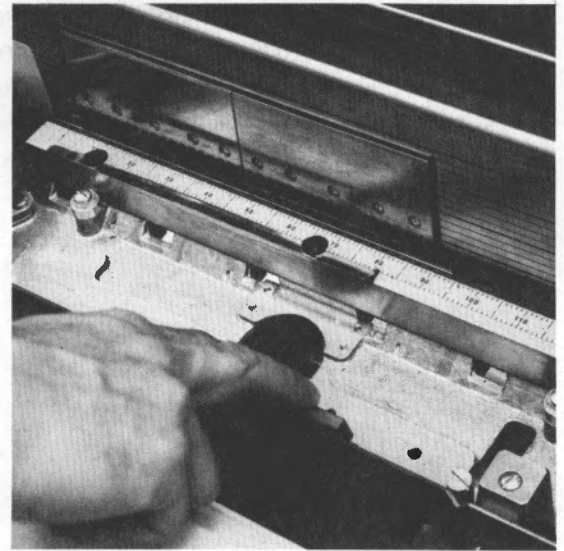


### Closing the Cover

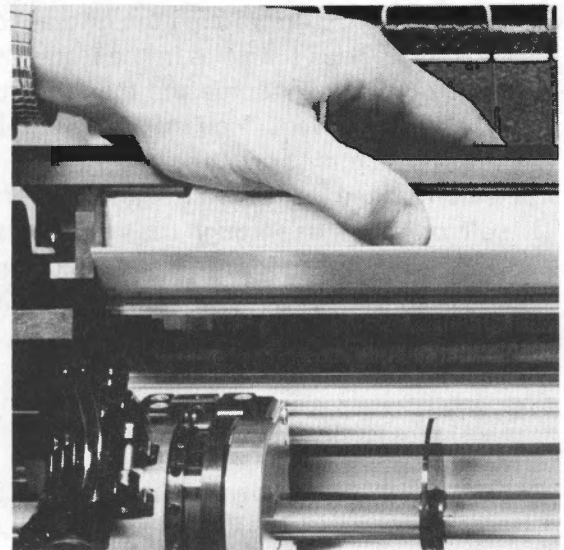
Lower the cover to the closed position and press down firmly to latch it closed.

### Loading Forms, Single-Carriage Printer

1. Open the cover. (See "Opening the Cover.")
2. Pull the Print Unit Release Lever toward the front of the printer to open the forms path.

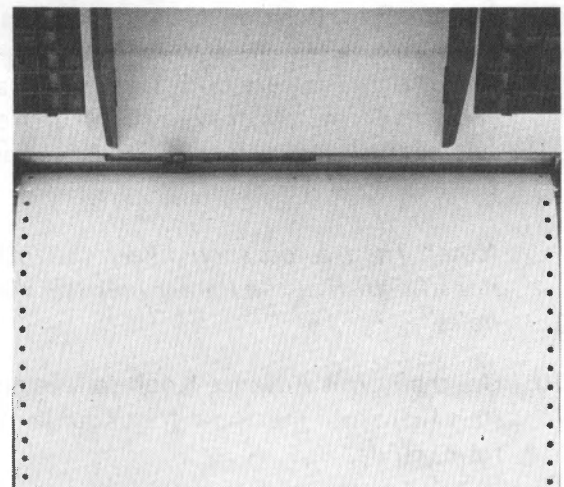


3. Open the tractor covers on both sides of the forms path. (The tractor covers are held closed by spring tension.)
4. Open the upper forms guide by pressing in on its latch.



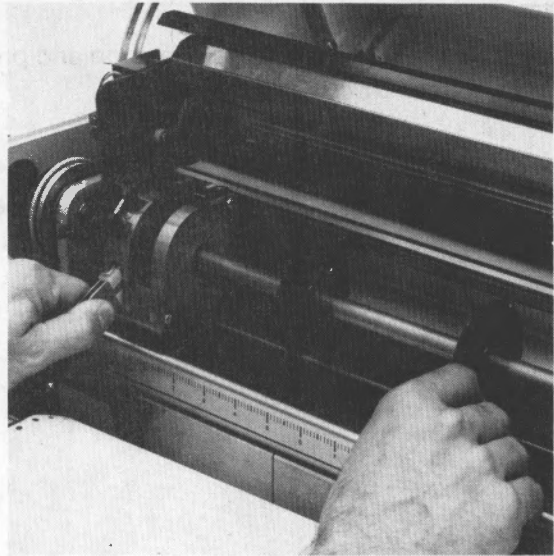
5. Go to the rear of the printer and slide the two Forms Chute Guides apart so the form can be fed in between them.
6. Feed about 15–20 inches (38.1–50.8 cm) of forms squarely into the forms chute. See adjacent photo. The end of the forms should protrude from the other side of the printer. If the forms slide out, feed in more forms until they stay in the printer.

**Note:** Some forms are easier to feed if the first and second sheets are folded double.

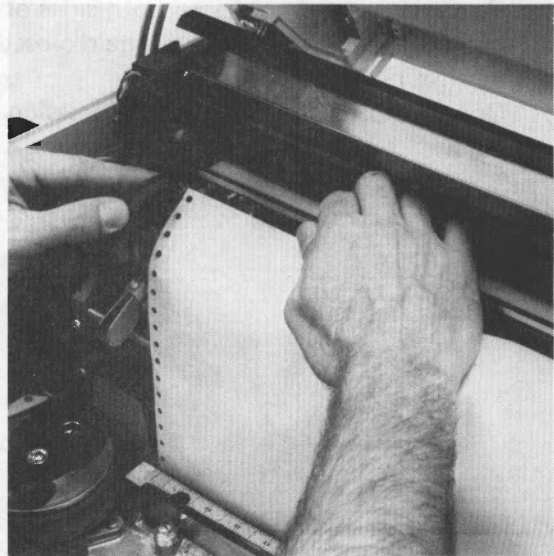




7. Go to the front of the printer and squeeze the Tractor Release Levers together and slide the forms tractors to the proper width and approximate position for the forms that you are loading. Then slide each of the two center forms guides so that they are equally spaced between the tractors.



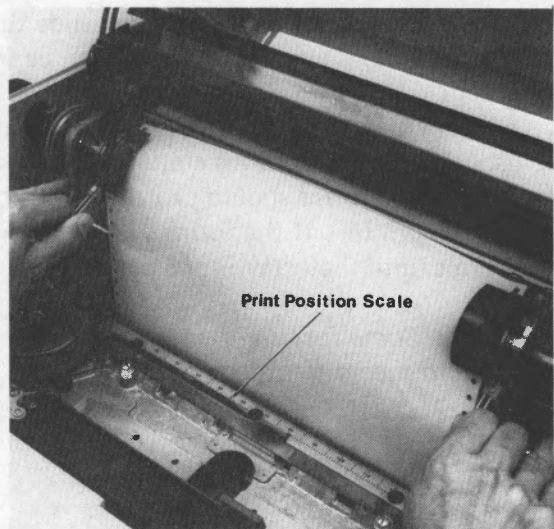
8. Pull the forms up through the printer to the top of the tractors. Place the holes in the forms over the tractor pins on one side and then the other and close the tractor covers. You may have to reposition the forms tractors to hold the paper even. You can make sure that the forms are straight by inserting the top pin on each side through the same relative hole on both sides of the forms. For example, put the top pin on each side through the third hole from the top on both sides of the form.



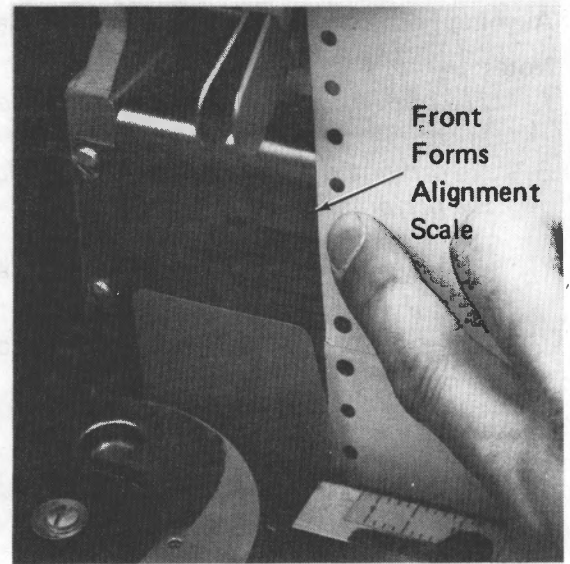
9. Use the Print Position Scale to check the alignment of the forms. If you have to reposition the forms to the left or right, squeeze both Tractor Release Levers and slide the forms left or right to the desired position. Just release the levers to lock the tractors and the forms in place.

**Note:** *The tractors should keep the forms taut, but not so tight that the tractor pins tear the form-feed holes.*

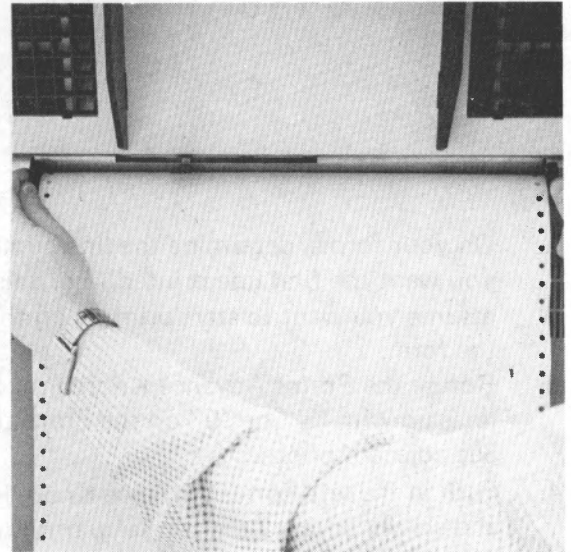
10. Use the Forms Advance Knob to feed enough forms to start them into the upper forms guide. Close the upper forms guide.



11. Note the number on the front Forms Alignment Scale where the left edge of the form is located. Use this number for reference when you align the form in the forms chute (next step).



12. Go to the rear of the printer and align the right edge (viewed from the rear) of the forms to the same number on the rear Forms Alignment Scale that you noted in the previous step. Slide the rear Form Chute Guides in to just touch the edges of the forms. See adjacent photo. Position the stack or box of forms that will be feeding into the printer so that the forms feed straight up and do not rub against the Form Chute Guides.
13. Go back to the front of the printer and close the print unit by pushing the Print Unit Release Lever toward the rear of the printer.
14. Turn the Forms Advance Knob and make sure that the paper feeds properly.
15. Align the forms to the first print line (next procedure).

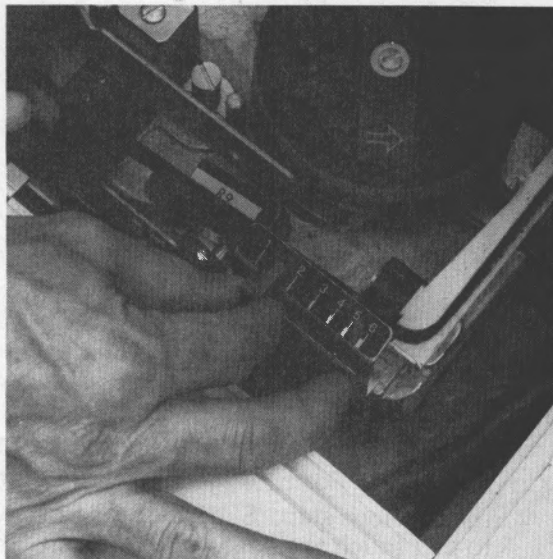


## Aligning Forms to First Print Line, Single-Carriage Printer

### Notes:

1. *The printer must be turned on to properly align the forms.*
2. *No printing should occur within 1/6 inch (4.23 mm) of the perforation.*

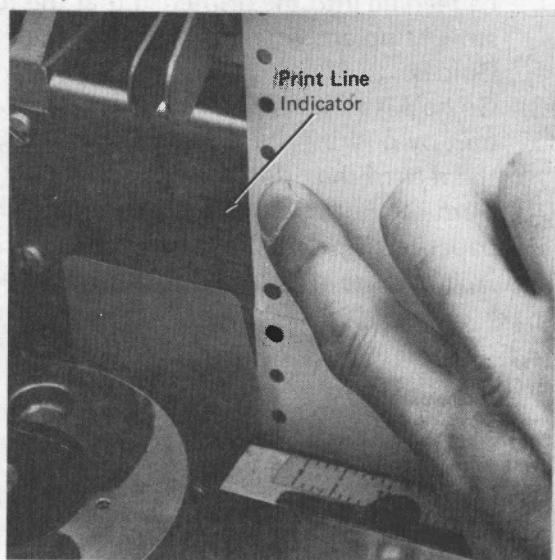
1. Set the Forms Thickness Control to the number of parts in the forms that you are loading: 1 for one-part forms, 2 for two-part forms, 3 for three-part forms, and so on.



2. On your forms, determine the line number on which you want the first line printed. For this procedure, assume you want to start printing on the eighth line of the form.
3. Rotate the Forms Advance Knob until the perforation lines up with "4" or "5" on the Print Line Indicator. See adjacent photo.
4. Push in the left Forms Advance Knob, hold it there, and slowly advance the forms up until the perforation lines up with "8" on the Print Line Indicator.

If you advance the forms too far, you may back the forms down and realign as follows:

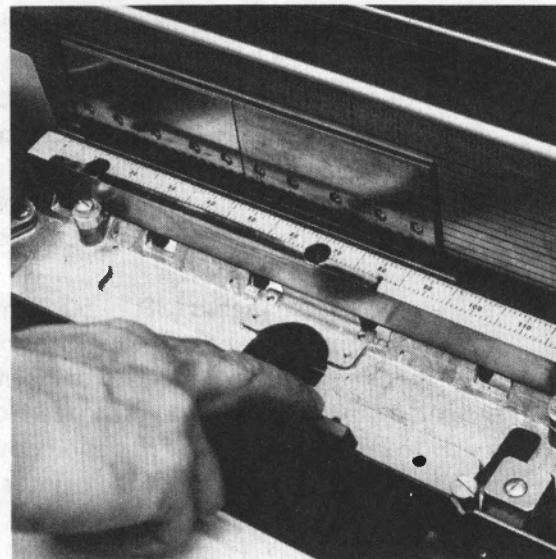
- a. Open the print unit by pulling the Print Unit Release Lever to the front of the printer.
  - b. Rotate the Forms Advance Knob backward until the perforation is at least three lines below the desired print line. If the forms do not back down through the forms chute, pull the slack forms out the rear of the printer.
  - c. Close the print unit by pushing the Print Unit Release Lever toward the rear of the printer.
  - d. Perform steps 2 through 4 again.
5. Close the cover. The forms are installed and properly aligned; you can now press the START PRINT switch to begin printing.





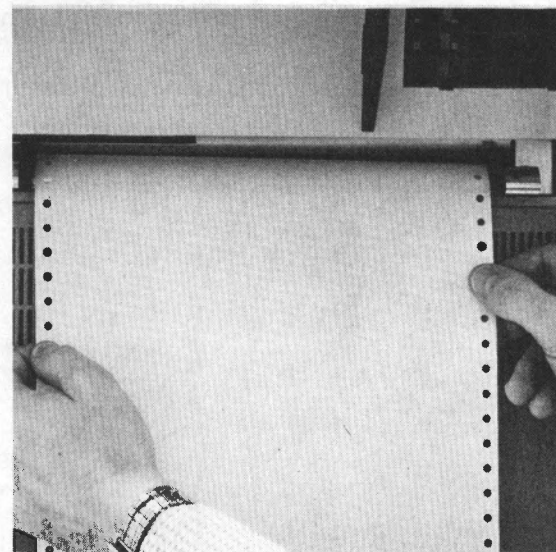
### Loading Forms, Two-Carriage Printer

1. Open the cover. (See "Opening the Cover.")
2. Pull the Print Unit Release Lever toward the front of the printer to open the forms path.



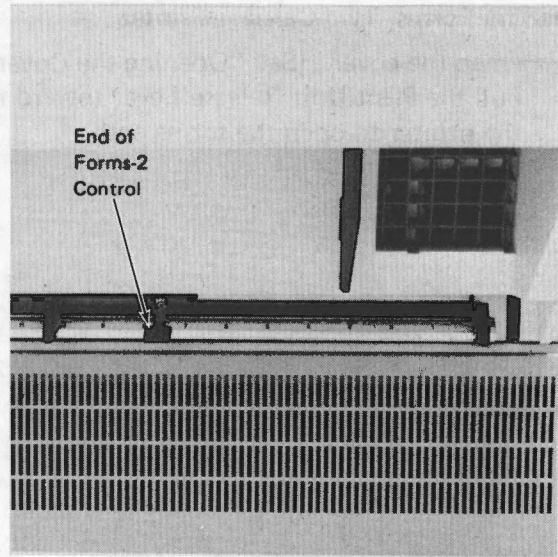
3. Go to the rear of the printer and set the four Forms Chute Guides to allow feeding of the two forms: one at either end and two between the two forms.
4. Feed about 15–20 inches (38.1–50.8 cm) of the carriage-1 form squarely into the right side of the forms chute. See adjacent photo. The end of the forms should protrude from the other side of the printer. If the forms slide out, feed in more forms until they stay in the printer.

**Note:** *Some forms are easier to feed if the first and second sheets are folded double.*

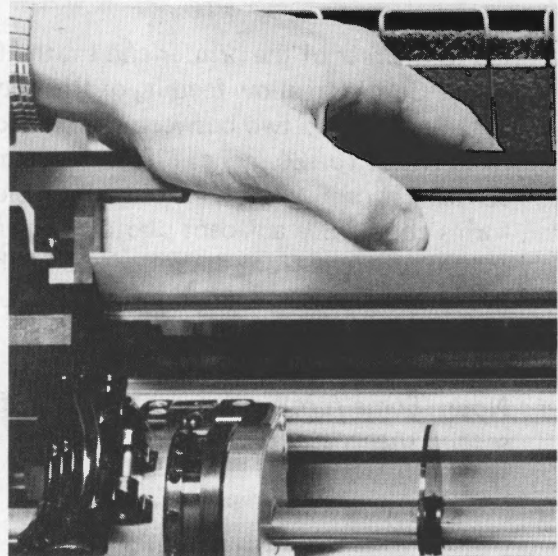




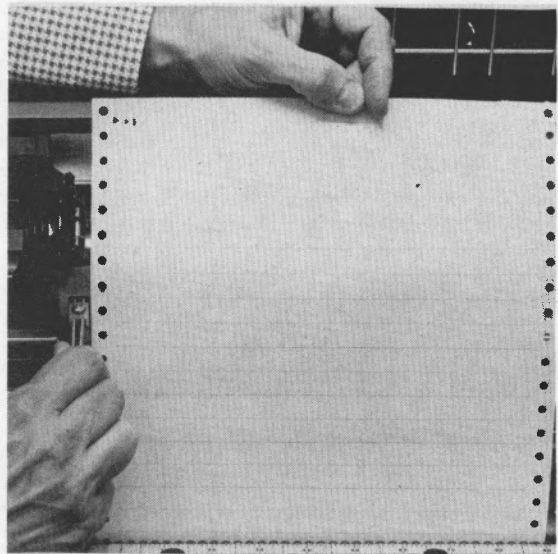
5. Move the right center Forms Chute Guide to the right until it touches the left edge of the form in carriage-1.
6. Set the End of Forms-2 control to the position near the center of the carriage-2 form. To move the control, press down on the lever and slide the control horizontally until it enters the proper position. When the control is in one of the four positions, the control lever will move up.
7. Feed about 15–20 inches (38.1–50.8 cm) of the carriage-2 form squarely into the forms chute. Be sure the forms are under the End of Forms-2 control. The end of the forms should protrude from the other side of the printer. If the forms slide out, feed in more forms until they stay in the printer.



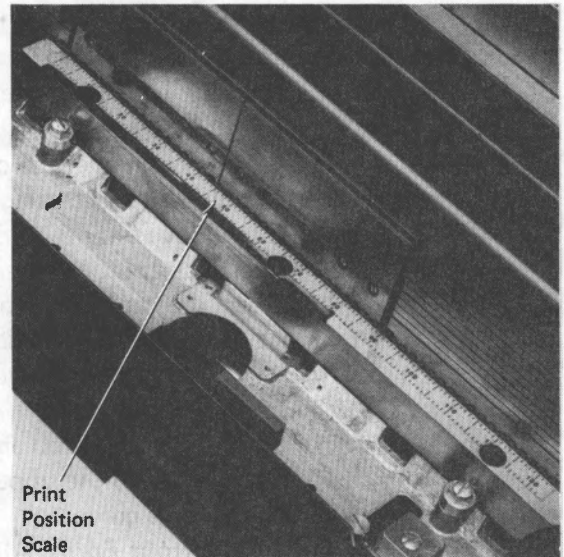
8. Go to the front of the printer and open the carriage-1 tractor covers. (The tractor covers are held closed by spring tension.)
9. Open the upper forms guide by pressing in on its latch.



10. Squeeze the Forms Tractor Release Levers together and slide the tractors for carriage-1 (left and center tractors) to the approximate position to handle the form in carriage-1. Then slide the two center forms guides so that they are equally spaced between the carriage-1 tractors.
11. Place the left holes in the form over the left tractor pins.



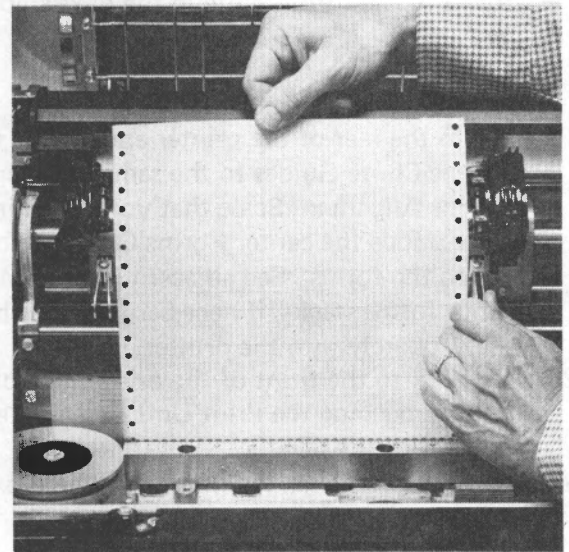
12. Move the left tractor and align the forms using the Print Position Scale.



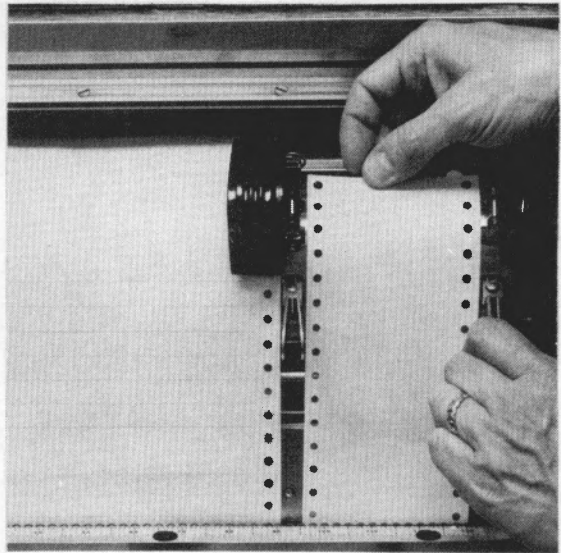
13. Place the right holes in the form over the center tractor pins. Make sure the forms are straight by inserting the top pin on each side through the same relative hole on both sides of the forms. For example, put the top pin on each side through the third hole from the top on both sides of the form.
14. Close the carriage-1 tractor covers.
15. Check the alignment of the forms with the Print Position Scale.

**Note:** *The tractors should keep the forms taut but not so tight that the tractor pins tear the form-feed holes.*

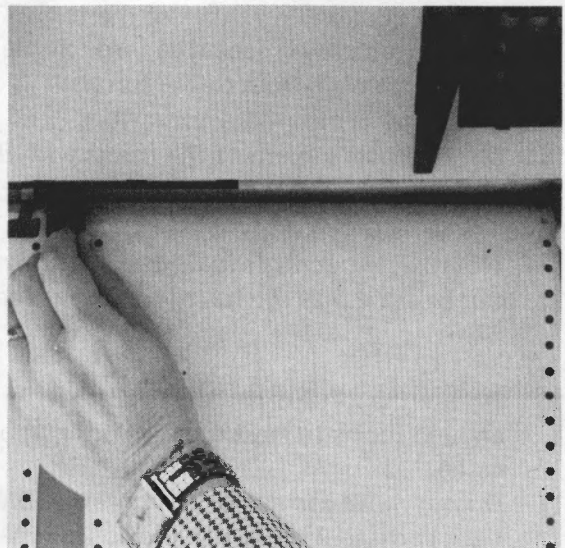
16. Rotate the left Forms Advance Knob and feed enough forms to start them into the upper forms guide.
17. *Do not move the center tractor assembly.* Move the right carriage-2 tractor to the approximate position to handle the forms in carriage-2. Then slide the center forms guide midway between the two tractors.



18. Open the carriage-1 tractor covers. Pull the forms up through the printer to the top of the tractor pins. Place the right holes in the form over the right tractor pins.
19. Place the left holes in the form over the center tractor pins. Be sure the forms in carriage-2 are square on the tractors. Move only the right tractor to make the form in carriage-2 taut.
20. Close the carriage-2 and the center tractor covers.
21. Check the alignment of the form in carriage-2 with the Print Position Scale. If you have to move carriage-2, then carriage-1 must also be moved.
22. Rotate the right Forms Advance Knob and feed enough forms to start them into the upper forms guide. Close the upper forms guide.
23. Note the numbers on the front Forms Alignment Scale where the outer edges of each form is located. Use these numbers for reference when you align the forms in the forms chute in the next step.



24. Go to the rear of the printer and set the two outer Forms Chute Guides to the same numbers on the rear Forms Alignment Scale that you noted in the previous step. Move the center Forms Chute Guides to just touch the forms. See adjacent photo. Move both input forms stacks, if necessary, so that both forms feed squarely into the printer.
25. Go back to the front of the printer and close the print unit by pushing the Print Unit Release Lever toward the rear of the printer.
26. Align the forms to the first print line (next procedure).



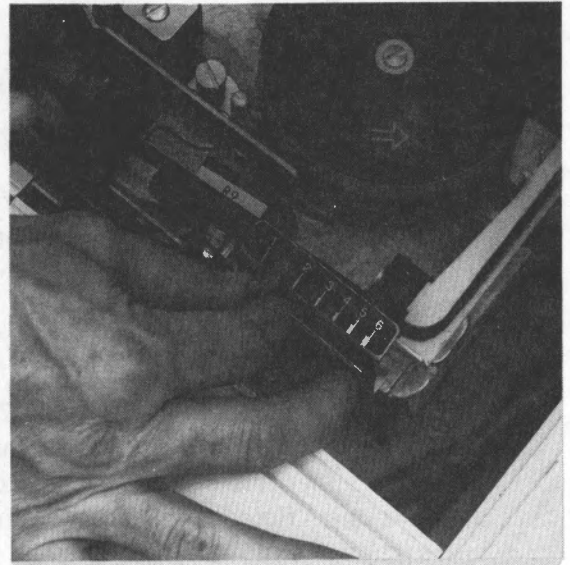
### Aligning Forms to First Print Line, Two-Carriage Printer

#### Notes:

1. *The printer must be turned on to properly align the forms.*
2. *No printing should occur within 1/6 inch (4.23 mm) of the perforation.*



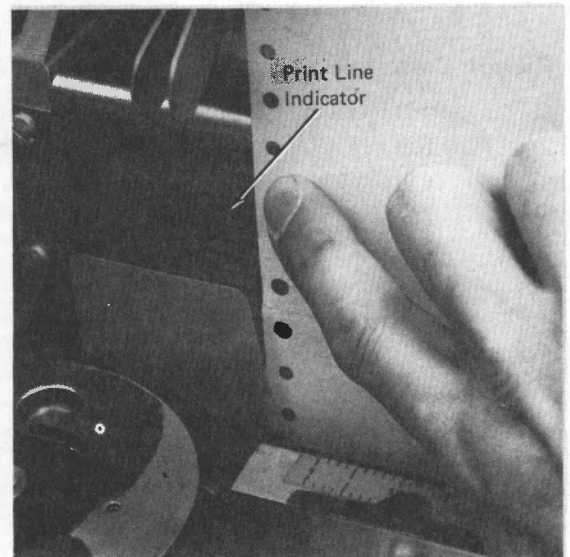
1. Set the Forms Thickness Control to the average number of parts of the two forms being used. For example, if a two-part and a three-part form are used, set the control midway between the "2" and the "3".



2. On your forms, determine the line number on which you want the first line printed. For this procedure, assume you want to start printing on the eighth line of both forms.
3. Rotate the left Forms Advance Knob until the perforation in carriage-1 lines up with "4" or "5" on the left Print Line Indicator.
4. Push in the left Forms Advance Knob, hold it there, and slowly advance the forms up until the perforation lines up with "8" on the left Print Line Indicator.
5. Repeat steps 3 and 4 using the right Forms Advance Knob and right Print Line Indicator to align the carriage-2 forms.

If you advance either form too far, both forms should be realigned as follows:

- a. Open the print unit by pulling the Print Unit Release Lever to the front of the printer.
  - b. Rotate each Forms Advance Knob backward until each perforation is at least three lines below the desired print line. If the forms do not back down through the forms chute, pull the slack forms out the rear of the printer.
  - c. Close the print unit by pushing the Print Unit Release Lever toward the rear of the printer.
  - d. Perform steps 2 through 5 again.
6. Close the cover. The forms are installed and properly aligned. You can now press the START PRINT switch to begin printing.





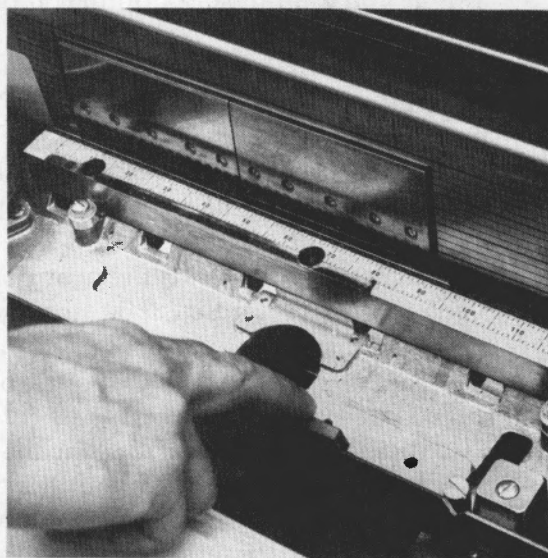
## Removing Forms

**Note:** *Do not remove forms from the 3618 while printing is taking place. Doing so will result in uneven printing.*

1. Press the STOP PRINT switch.
2. Tear the forms on one of the perforations. (If necessary, advance the printed forms up to a perforation and tear them off.) You may then do either step 3 or 4.
3. To continue printing on the forms left in the printer, realign the forms if necessary. (Follow the applicable forms alignment procedure from step 2.)
4. To remove unused forms from the printer, open the cover, the upper forms guide, the tractor covers, and the print unit. Remove the forms from the upper forms guide and the tractors. Then go to the rear of the printer and carefully pull the forms out through the forms chute.

## Ribbon Cassette Removal

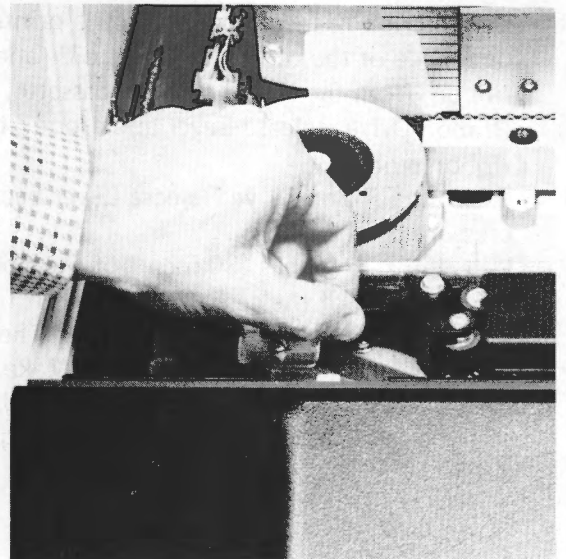
1. Open the cover. (See "Opening the Cover.")
2. Pull the Print Unit Release Lever toward the front of the printer to open the print unit.



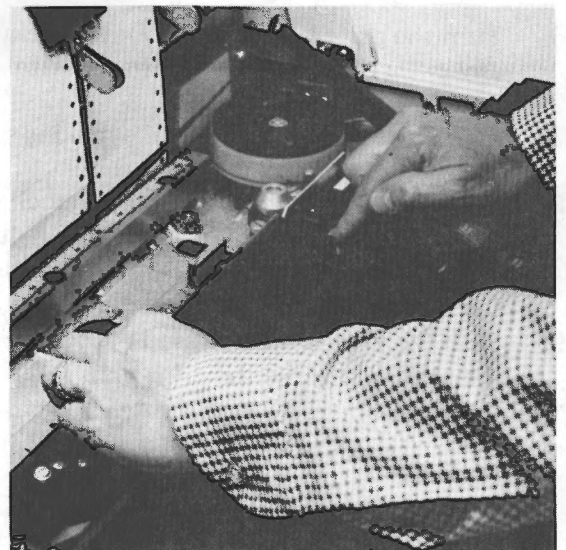
3. Raise both ribbon guides.



4. Open the Ribbon Drive Release Lever to release the pressure on the ribbon.

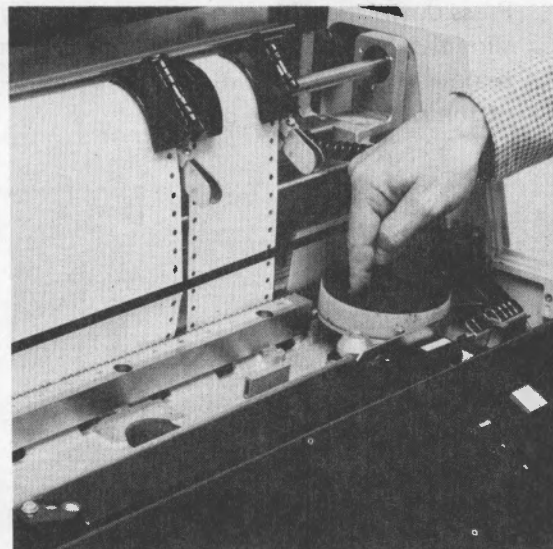
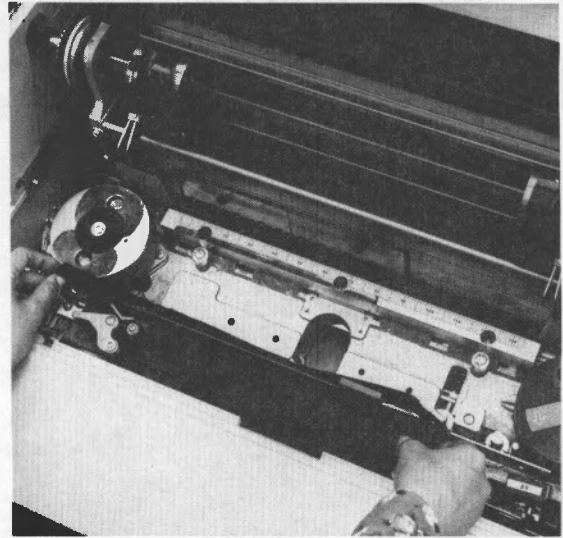


5. Press down the ribbon cassette release button and slide the cassette to the right until it is free. Then, remove the ribbon from the ribbon guides and dispose of the ribbon and the cassette.



## Ribbon Cassette Replacement

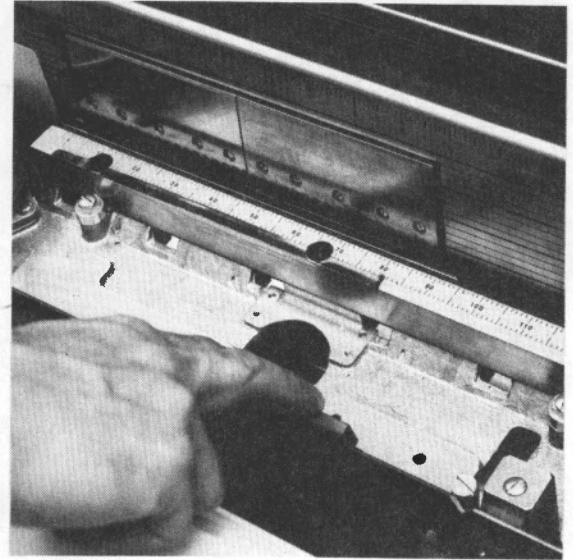
1. Lay the cassette on the printer with the left end (the curved end) about 1 inch (2.54 cm) from the ribbon drive rolls. The right end of the cassette will cover the ribbon cassette release button.
2. Pull about 6 inches (15.2 cm) of ribbon out of the left end of the cassette, put it between the ribbon drive rollers, and press down on the cassette and slide it to the left until the ribbon cassette release button slides up to hold the cassette.
3. Use the ribbon feed diagram on the printer (on the underside of the top cover) as a guide and feed the ribbon, from the left end of the cassette, through the Ribbon Drive Release Lever and around the left ribbon guide.
4. Push the Ribbon Drive Release Lever back to put pressure on the ribbon.
5. Pull about 12 inches (30.5 cm) of the ribbon out of the right end of the cassette and feed it from the left ribbon guide around the right guide. The ribbon is manufactured with one twist in it. Make sure you keep the twist in the ribbon near the right end of the cassette (between the cassette and the right ribbon guide).
6. Turn the print belt pulley counterclockwise to wind any extra ribbon back into the cassette. See adjacent photo.
7. Lower the ribbon guides while making sure that the ribbon goes in back of the type belt.
8. Turn the print belt pulley counterclockwise again to feed ribbon down between the type belt and the ribbon shield. Continue turning the pulley and make sure that the ribbon feeds correctly.
9. Push the Print Unit Release Lever toward the rear of the printer to close the print unit.
10. Close the cover.



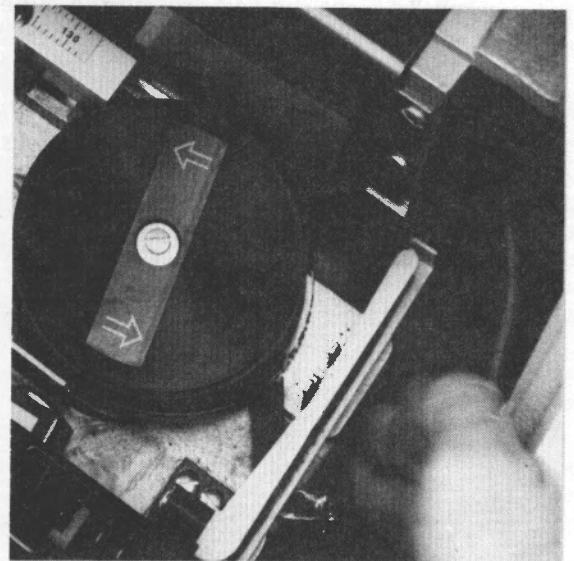


### Print Belt Removal

1. Open the cover. (See "Opening the Cover.")
2. Pull the Print Unit Release Lever toward the front of the printer to open the print unit.



3. Pull the Print Belt Release Lever toward the front of the machine to loosen the belt tension. See adjacent photo.
4. Lift the print belt off the pulleys and place it in its container. Take care not to bend the belt sharply.





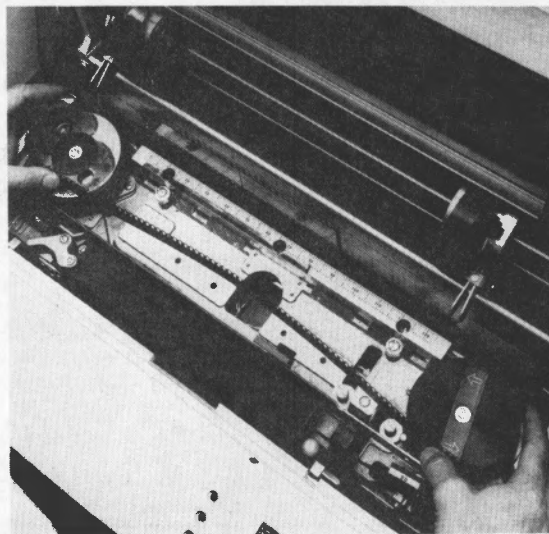
## Print Belt Replacement

1. Raise both ribbon guides.
2. Push the Print Belt Release Lever toward the rear of the printer.

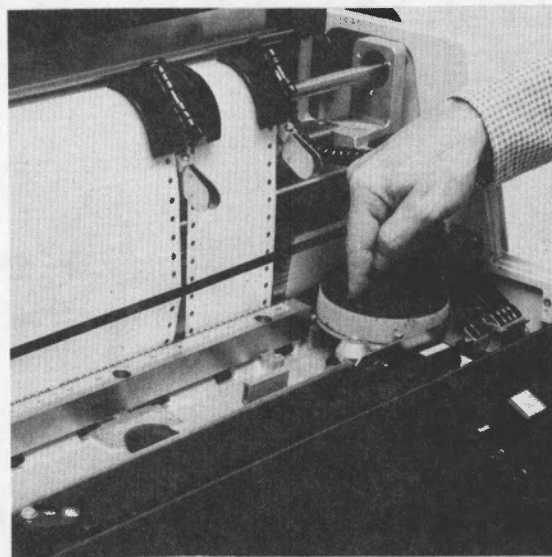


3. Pick up the print belt with the typeface up, and carefully place the belt around the pulleys and in back of the belt guard.

**Note:** *At this point, the belt does not have to be down all the way to the bottom of the pulleys.*



4. Turn the print belt pulley counterclockwise. The print belt should move down to its proper position on the pulleys. If the belt does not move down, there is interference below the belt or the belt is positioned incorrectly. Remove the belt, check the belt path, and reinstall the belt.
5. Lower the ribbon guides while making sure that the ribbon goes in back of the type belt.
6. Turn the print belt pulley counterclockwise again and check to make sure that the print belt and the ribbon are both feeding normally.
7. Push the Print Unit Release Lever toward the rear of the printer to close the print unit.
8. Close the cover.



**Contents – Financial Services Terminals**

- 3606 Financial Services Terminal**
- 3608 Printing Financial Services Terminal**

This page precedes the 3606 Financial Services Terminal contents page.

CONTENTS - Financial Services Division  
2016 Financial Services Division  
2016 Financial Services Division

2016 Financial Services Division

The following table lists the financial services companies that

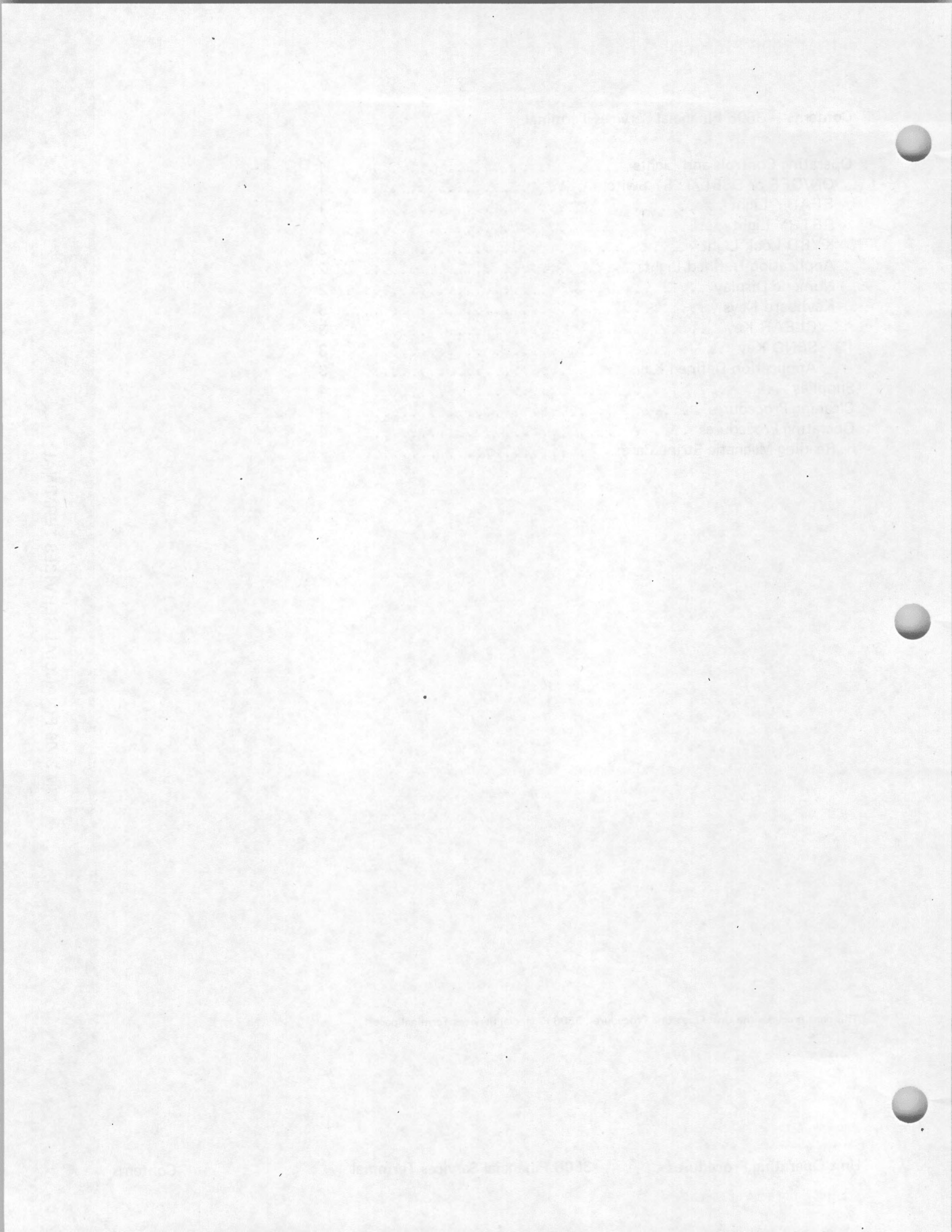
Financial Services Division  
Financial Services Division  
Financial Services Division

## Contents – 3606 Financial Services Terminal

|                                     |   |
|-------------------------------------|---|
| Operating Controls and Lights ..... | 1 |
| ON/OFF or DSBL/TEST Switch .....    | 1 |
| READY Light .....                   | 1 |
| RETRY Light .....                   | 1 |
| KYBD Lock Light .....               | 2 |
| Application-Defined Lights .....    | 2 |
| Numeric Display .....               | 2 |
| Keyboard Keys .....                 | 3 |
| CLEAR Key .....                     | 3 |
| SEND Key .....                      | 3 |
| Application-Defined Keys .....      | 3 |
| Supplies .....                      | 4 |
| Cleaning Procedures .....           | 4 |
| Operating Procedures .....          | 4 |
| Reading Magnetic Stripe Cards ..... | 4 |

This page precedes the Unit Operating Procedures, 3606 Financial Services Terminal page 1.





## IBM 3606 Financial Services Terminal

The 3606 consists of a display, a keyboard, and a magnetic stripe reader. Also provided are indicator lights for showing status information.

There are two models of the 3606; both models are operated identically. For a description of the 3606 Financial Services Terminal, refer to *Introducing the IBM 3600 Finance Communication System*, GA27-2764.

### OPERATING CONTROLS AND LIGHTS

#### ON/OFF or DSBL/TEST Switch

The ON/OFF switch is located on the right side of the Model 1; press ON to turn the unit's power on, OFF to turn power off. (In some units, the — symbol is used to indicate ON and O to indicate OFF.)

The Model 2 does not have an ON/OFF switch. In its place is a three position DSBL/TEST switch. The DSBL position makes the unit non-operational, but maintains power on to support the remainder of the loop. The center position is the operational position. The TEST position is a momentary test mode position.

#### CAUTIONS:

1. Pressing the POWER ON/OFF switch to ON or OFF or the DSBL/TEST switch to TEST may cause errors on other terminals if they are in use on the same loop.
2. Unplugging the 3606-2 main power cord causes the loop the 3606-2 is part of to fail for as long as the 3606-2 is without power.

Turning the power off, in addition to conserving energy, activates a bypass circuit that functionally removes the unit from the loop without disconnecting the cables. This circuit provides a simple and rapid means to restore the loop operation if the terminal should malfunction.

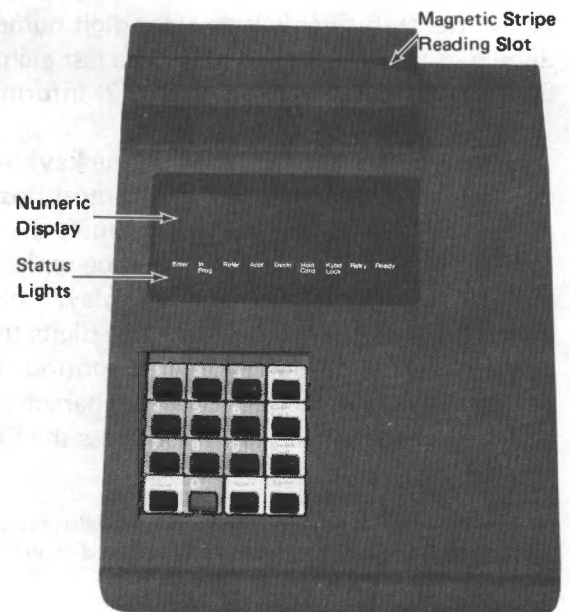
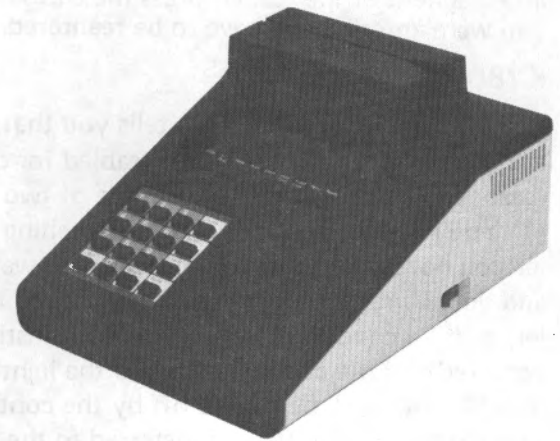
There is, however, a possible loop cable length problem between the units with power on; for details, refer to the *IBM 3600 Finance Communication System Configurator*, GA27-2762.

#### READY Light

The condition of the READY light tells you the status of the communications between the 3606 and the controller. When the light is on all the time, there are no communications problems. This is the normal operating state. If the light is *off* all the time or *flashing* on and off, it indicates that there is a communications problem between the 3606 and the controller. When it's *always off*, signals from the controller are not arriving at the 3606. When it's *flashing on and off*, signals from the controller are arriving at the 3606, but signals from the 3606 are not reaching the controller.

#### RETRY Light

The RETRY status light tells you that your keyboard and magnetic stripe reader are disabled because of a machine error or special condition. The light comes on as soon as the error or condition is detected. Therefore, you can assume the function you were using caused the light to turn on.



To turn off the RETRY light and activate your keyboard and magnetic stripe reader, press the CLEAR key. The data you were entering will have to be reentered.

### KYBD LOCK Light

The KYBD LOCK status light tells you that your keyboard and magnetic stripe reader are disabled for operational reasons. The light comes on for one of two reasons: (1) You have pressed the SEND key, telling the controller you have completed the message you were entering and you want that information transferred to the controller; or (2) a condition, defined by your institution, has occurred and the controller caused the light to be turned on. The light will be turned off by the controller after the information has been transferred to the controller.

### Application-Defined Lights

The name and function of the six status lights to the left of the KYBD LOCK light are determined by your institution. (Refer to the description of these lights provided by your institution; it should be placed in this subsection of the operating guide.) The suggested functions are:

1. ENTER
2. IN PROG (In Progress)
3. REFER
4. ACPT (Accept)
5. DECLN (Decline)
6. HOLD CARD

The display filter with the lettering can be easily replaced with one having the unique names defined by your institution.

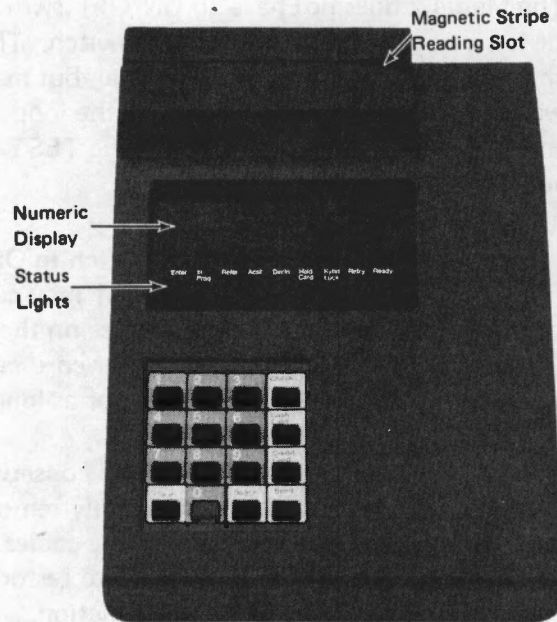
The lights are turned on and off by the controller. They are also turned off when you press the CLEAR key.

### Numeric Display

Above the status lights is an eight-digit numeric display. Shown in this display are: (1) The last eight digits you have entered on the keyboard, or (2) information sent by the controller to you.

When you are entering data on the keyboard, the first digit you enter appears in the right-most position of the display. The second digit you enter causes the first one to be moved one position to the left and be replaced by the new digit. This continues across the display, with the left-most digits "rolling" off the display. The digits that have "rolled" off are not lost; you may continue to enter your data (up to a maximum of 55 data characters\*); the 3606 stores all of the entries until you press the SEND key.

\*If data is also entered via the magnetic stripe reader, the number of characters read plus the number of characters entered on the keyboard must not exceed 55 data characters.





The display can be erased by the controller or by you whenever you press a function key (that is, a nonnumeric key).

### Keyboard Keys

There are 16 keys: the ten numerics (0–9) and six function keys. Two of the function keys are fixed (CLEAR and SEND) and the other four are application defined keys.

### CLEAR Key

The CLEAR key is used to erase all of the data you have entered since the last time you pressed SEND, the numeric display, the RETRY status light, and the six application-defined status lights. Press this key if you realize an entry error occurred, and reenter the corrected data.

### SEND Key

The SEND key is used to tell the controller that you have completed the message you were entering and you want that information transferred to the controller. Press this key when you are satisfied that the message has been correctly entered; the KYBD LOCK light will come on and prevent further data entry until after the information has been transferred to the controller.

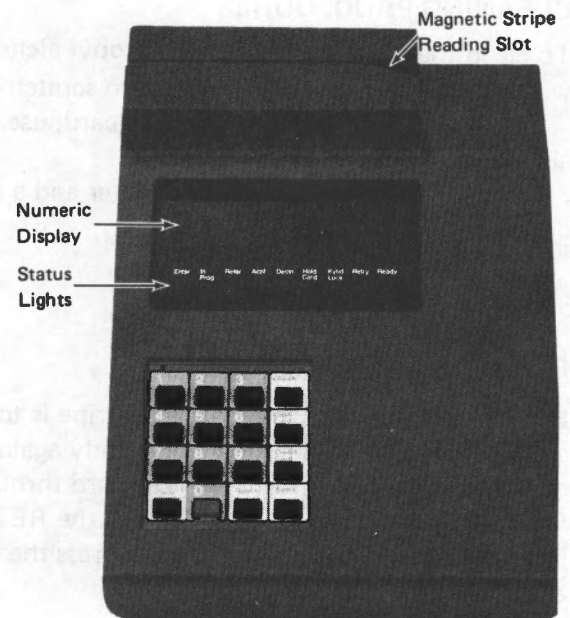
### Application-Defined Keys

The name and function of the four function keys (other than the CLEAR and SEND keys) are determined by your institution. (Refer to the description of these keys provided by your institution; it should be placed in this chapter of the operating guide.) These function keys are stored as unique characters when they are part of data entry message; however, the numeric display is erased.

The suggested functions are:

1. CHECK
2. CASH CARD
3. CREDIT CARD
4. SPACE

The keyboard overlay with the lettering can be easily replaced with one having the unique names defined by your institution.





## SUPPLIES

Supplies for the 3606 are listed under "Installation Details."

## CLEANING PROCEDURES

To clean the display filter, use isopropyl alcohol. Apply with a soft cloth, being careful not to scratch the filter.

To clean the magnetic stripe on a card, use isopropyl alcohol and a clean cloth.

To clean the covers, use warm water and a mild detergent.

## OPERATING PROCEDURES

### Reading Magnetic Stripe Cards

Hold the card so that the magnetic stripe is toward you and down; then, holding the card firmly against the bottom of the reading slot, briskly pass the card through the slot from right to left. If an error occurs, the RETRY status light will come on. If this happens, press the CLEAR key and repeat the operation.

**Contents – 3608 Printing Financial Services Terminal**

|  |   |
|--|---|
| Operating Controls and Lights .....        | 1 |
| ON/OFF or DSBL UNIT/TEST UNIT Switch ..... | 1 |
| READY Light .....                          | 1 |
| RETRY Light .....                          | 2 |
| KYBD. LOCK Light .....                     | 3 |
| Application-Defined Lights .....           | 3 |
| Numeric Display .....                      | 3 |
| Keyboard Keys .....                        | 4 |
| CLEAR Key .....                            | 4 |
| SEND Key .....                             | 4 |
| Application-Defined Keys .....             | 4 |
| Supplies .....                             | 5 |
| Cleaning Procedures .....                  | 5 |
| Operating Procedures .....                 | 5 |
| Reading Magnetic Stripe Cards .....        | 5 |
| Inserting Cut Forms .....                  | 5 |
| Cut Form Jam Removal .....                 | 6 |
| Ink Roll Removal .....                     | 6 |
| Ink Roll Replacement .....                 | 6 |

This page precedes the Unit Operating Procedures, 3608 Printing Financial Services Terminal page 1.

|   |                                      |
|---|--------------------------------------|
| 1 | ON/OFF or DSBL UNIT TEST UNIT Switch |
| 1 | READY Light                          |
| 2 | READY Light                          |
| 3 | RYB LOCK Light                       |
| 3 | Application Defined Lights           |
| 3 | Printer Display                      |
| 4 | Keyboard Keys                        |
| 4 | CLEAR Key                            |
| 4 | SEND Key                             |
| 4 | Application Defined Keys             |
| 5 | Buttons                              |
| 5 | Control Procedures                   |
| 5 | Queueing Procedures                  |
| 5 | Reading Magnetic Cards               |
| 5 | Printing Out Form                    |
| 5 | Get Operator Removal                 |
| 5 | Job Roll Removal                     |
| 5 | Job Roll Reassignment                |

## IBM 3608 Printing Financial Services Terminal

The 3608 consists of a display, a keyboard, a magnetic stripe reader, and a printer for sales slips, checks, and similar documents. Also provided are indicator lights for showing status information.

There are two models of the 3608; both models are operated identically. For a description of the 3608 Printing Financial Services Terminal, refer to *Introducing the IBM 3600 Finance Communication System, GA27-2764*.

### OPERATING CONTROLS AND LIGHTS ON/OFF or DSBL UNIT/TEST UNIT Switch

The ON/OFF switch is located on the front of the Model 1; press ON to turn the unit's power on, OFF to turn power off. (In some units, the — symbol is used to indicate ON and O to indicate OFF.)

The Model 2 does not have an ON/OFF switch. In its place is a three position DSBL UNIT/TEST UNIT switch. The DSBL UNIT position makes the unit non-operational, but maintains power on to support the remainder of the loop. The center position is the operational position. The TEST UNIT position is a momentary test mode position.

### CAUTIONS:

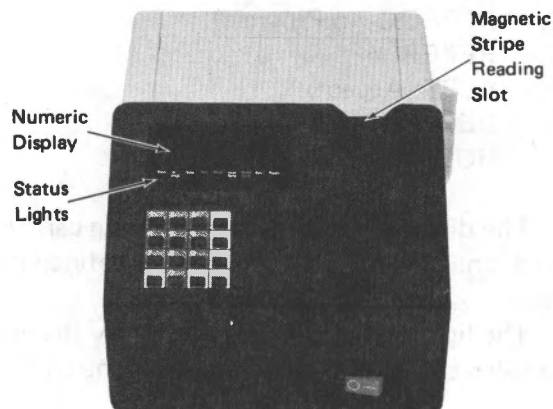
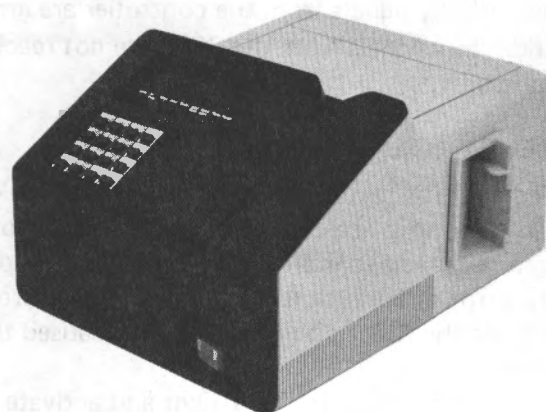
1. Pressing the POWER ON/OFF switch to ON or OFF or the DSBL UNIT/TEST UNIT position to TEST UNIT may cause errors on other terminals if they are in use on the same loop.
2. Unplugging the 3608-2 main power cord will cause the loop the 3608-2 is part of to fail for as long as the 3608-2 is without power.

Turning the power off, in addition to conserving energy, activates a bypass circuit that functionally removes the unit from the loop without disconnecting the cables. This circuit provides a simple and rapid means to restore the loop operation if the terminal should malfunction.

There is, however, a possible loop cable length problem between the units with power on; for details, refer to the *IBM 3600 Finance Communication System Configurator, GA27-2762*.

### READY Light

The condition of the READY light tells you the status of the communications between the 3608 and the controller. When the light is on all the time, there are no communications problems. This is the normal operating state. If the light is *off* all the time or *flashing* on and off, it indicates that there is a communications problem between the 3608





and the controller. When it's *always off*, signals from the controller are not arriving at the 3608. When it's *flashing on and off*, signals from the controller are arriving at the 3608, but signals from the 3608 are not reaching the controller.

### RETRY Light

The RETRY status light tells you that your keyboard and magnetic stripe reader are disabled because of a machine error or special condition. The light comes on as soon as the error or condition is detected. Therefore, you can assume the function you were using caused the light to turn on.

To turn off the RETRY light and activate your keyboard and magnetic stripe reader, press the CLEAR key. The data you were entering will have to be reentered.

### KYBD LOCK Light

The KYBD LOCK status light tells you that your keyboard and magnetic stripe reader are disabled for operational reasons. The light comes on for one of two reasons:

- (1) You have pressed the SEND key, telling the controller you have completed the message you were entering and you want that information transferred to the controller;
- or (2) a condition, defined by your institution, has occurred and the controller caused the light to be turned on. The light will be turned off by the controller after the information has been transferred to the controller.

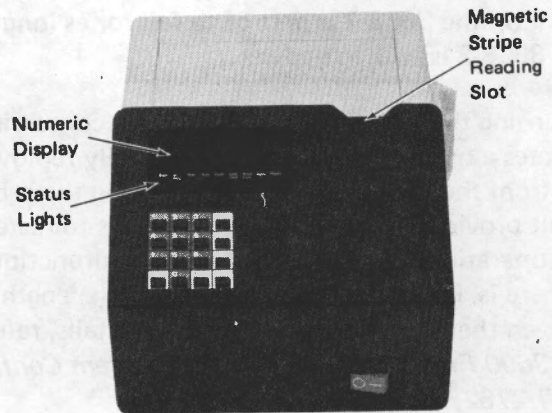
### Application-Defined Lights

The name and function of the six status lights to the left of the KYBD LOCK light are determined by your institution. (Refer to the description of these lights provided by your institution; it should be placed in this chapter of the operating guide.) The suggested functions are:

1. ENTER
2. IN PROG (In Progress)
3. REFER
4. ACPT (Accept)
5. DECLN (Decline)
6. HOLD CARD

The display filter with the lettering can be easily replaced with one having the unique names defined by your institution.

The lights are turned on and off by the controller. They are also turned off when you press the CLEAR key.



## Numeric Display

Above the status lights is an eight-digit numeric display. Shown in this display are: (1) The last eight digits you have entered on the keyboard, or (2) information sent by the controller to you.

When you are entering data on the keyboard, the first digit you enter appears in the right-most position of the display. The second digit you enter causes the first one to be moved one position to the left and be replaced by the new digit. This continues across the display, with the left-most digits "rolling" off the display. The digits that have "rolled" off are not lost; you may continue to enter your data (up to a maximum of 55 data characters\*); the 3608 stores all of the entries until you press the SEND key.

The display can be erased by the controller or by you whenever you press a function key (that is, a nonnumeric key).

## Keyboard Keys

There are 16 keys: the ten numerics (0–9) and six function keys. Two of the function keys are fixed (CLEAR and SEND) and the other four are application defined keys.

### CLEAR Key

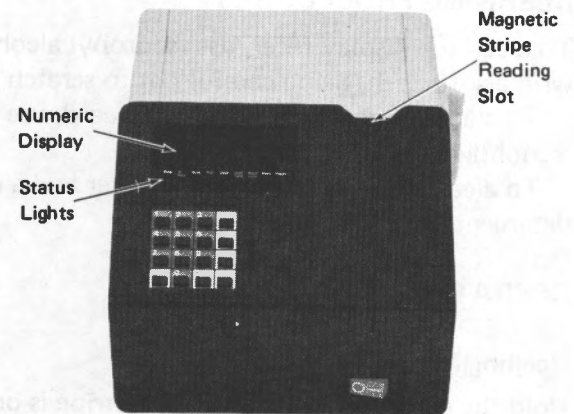
The CLEAR key is used to erase all of the data you have entered since the last time you pressed SEND, the numeric display, the RETRY status light, and the six application defined status lights. Press the key if you realize an entry error occurred, and reenter the corrected data.

### SEND Key

The SEND key is used to tell the controller that you have completed the message you were entering and you want that information transferred to the controller. Press this key when you are satisfied that the message has been correctly entered; the KYBD LOCK light will come on and prevent further data entry until after the information has been transferred to the controller.

### Application-Defined Keys

The name and function of the four function keys (other than the CLEAR and SEND keys) are determined by your institution. (Refer to the description of these keys provided by your institution; it should be placed in this chapter of the operating guide.) These function keys are stored



\*If data is also entered via the magnetic stripe reader, the number of characters read plus the number of characters entered on the keyboard must not exceed 55 data characters.

as unique characters when they are part of data entry message; however, the numeric display is erased.

The suggested functions are:

1. CHECK
2. CASH CARD
3. CREDIT CARD
4. SPACE

The keyboard overlay with the lettering can be easily replaced with one having the unique names defined by your institution.

## SUPPLIES

Supplies for the 3608 are listed under "Installation Details."

## CLEANING PROCEDURES

To clean the display filter, use isopropyl alcohol. Apply with a soft cloth, being careful not to scratch the filter.

To clean the magnetic stripe on a card, use isopropyl alcohol and a clean cloth.

To clean the covers, use warm water and a mild detergent.

## OPERATING PROCEDURES

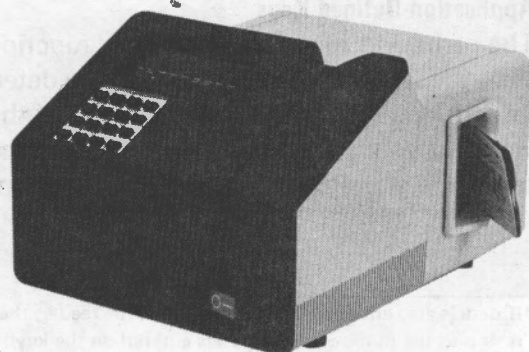
### Reading Magnetic Stripe Cards

Hold the card so that the magnetic stripe is on the right-hand side and down; then, holding the card firmly against the bottom of the reading slot, briskly pass the card through the slot from top to bottom. If an error occurs, the RETRY status light will come on. If this happens, press the CLEAR key and repeat the operation.

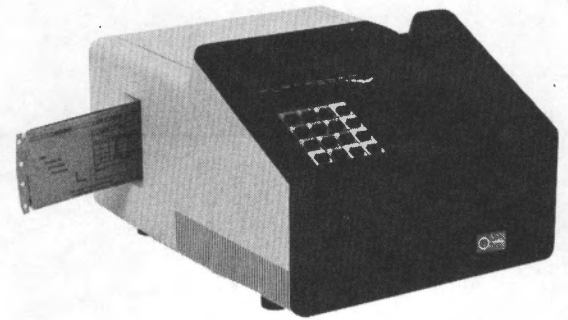
### Inserting Cut Forms

To insert a cut form, paper, or check for printing, hold the form with the face to be printed in an upright or reading position and, with the form resting on bottom of the right side printer entrance, gently push the left edge of the form into the slot until the printer "takes" the form.

**CAUTION:** Be sure there are no staples, paper clips, pins, or other metallic objects fastened to the form as they could cause a forms jam and permanent damage to the printing mechanism.



Remove the printed form from the left side printer exit slot after the printer stops "pushing" it out. Be sure to not insert a new form for printing until you have removed the printed form.



### Cut Form Jam Removal

If a form jams in the printer, open the top access cover. First attempt to back the form out by turning the Form Feed Knob counterclockwise. If this is not successful, turn the knob clockwise to advance the form to the exit. It may be necessary to feed the form back and forth several times to free the form. Do not try to pull the form out of the printer until it has been released by the mechanism; to do so may tear the form so you may be unable to grasp it.

After freeing the form, close the cover securely or you will be unable to use the unit.

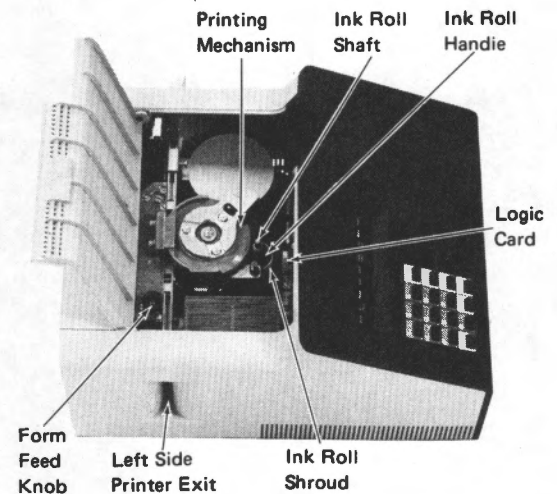
### Ink Roll Removal

To remove the ink roll, open the top access cover. Grasp the ink roll handle and move it toward the front of the unit. *Do not press the ink roll shroud against the logic card.* Lift the ink roll up off the shaft, wrap it in a piece of scrap paper, and discard it. The ink roll shroud will spring back against the mechanism when you remove the ink roll.

### Ink Roll Replacement

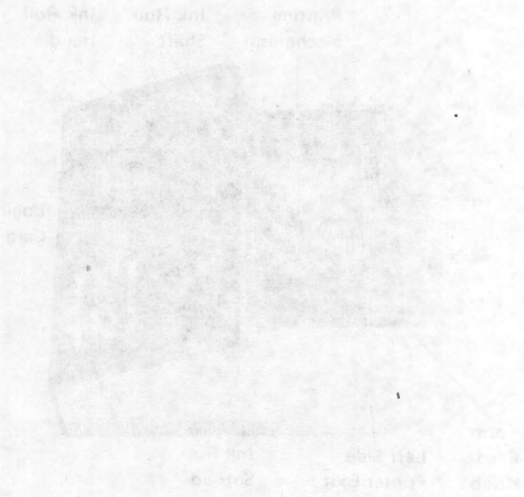
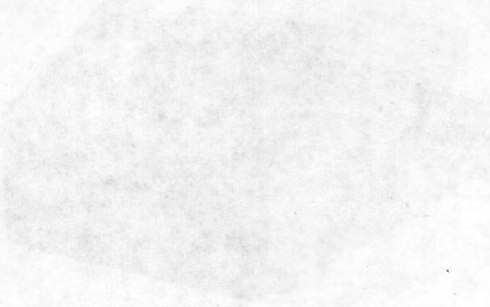
Open the wrapper of the new ink roll so that you can hold the handle, then remove and discard the wrapper. Place the bottom of the ink roll over the top of the shaft and move the shaft away from the printing mechanism just enough to let the ink roll slide down in place. Be sure the ink roll is all the way down into the shroud; then, let go of the handle to allow the spring to press the ink roll against the printing mechanism.

Close the cover securely or you will be unable to use the unit.





Remove the paper from the printer's output tray. After the printer stops printing, it out. Be sure to use a new form for printing. If you have used the printed form.



### Out Form Jam Removal

If a form jams in the printer, open the top access cover. First attempt to back the form out by turning the Form Feed Knob counterclockwise. If this is not successful, turn the knob clockwise to advance the form to the exit. If necessary, feel the form back and forth several times to free the form. Do not try to pull the form out of the printer until it has been released by the mechanism, to do so may tear the form and you may be unable to grasp it. After freeing the form, close the cover securely or you will be unable to use the printer.

### Ink Roll Removal

To remove the ink roll, open the top access cover. Grasp the ink roll handle and move it toward the front of the printer. Do not cross the ink roll shaft against the shaft. Lift the ink roll off the shaft, wrap it in a piece of scrap paper, and discard it. The ink roll should wrap around back against the mechanism when you remove the ink roll.

### Ink Roll Replacement

Open the wedge of the new ink roll so that you can hold the handle. Do not remove and discard the wedge. Place the bottom of the ink roll over the top of the shaft and move the shaft away from the printing mechanism just enough to let the ink roll slide down in place. Be sure the ink roll is all the way down into the shaft; then let go of the handle to allow the spring to push the ink roll against the printing mechanism. Close the cover securely or you will be unable to use the printer.

**Contents – Related Units**

**3614 Consumer Transaction Facility**

**RELATED UNITS**

This page precedes the 3614 Consumer Transaction Facility keying page.

Contents - Related Links  
2014 Consumer Transition Facility

The link to access the 2014 Consumer Transition Facility is located here.

Unit Operating Procedures - Related Links - Contents

This page precedes the Unit Operating Procedures, 3614 Consumer Transaction Facility page 1.



UNITED STATES DEPARTMENT OF JUSTICE

UNITED STATES DEPARTMENT OF JUSTICE

UNITED STATES DEPARTMENT OF JUSTICE

## **IBM 3614 Consumer Transaction Facility**

A separate manual, *IBM 3614 Consumer Transaction Facility Operator's Guide*, GA66-0001, provides operating information for the 3614. You may wish to put the 3614 Operator's Guide in this 3600 operating guide.

For a description of the 3614 Consumer Transaction Facility, refer to *Introducing the IBM 3600 Finance Communication System*, GA27-2764.

15th Street, Washington, D.C. 20004  
Telephone: (202) 462-1000  
Fax: (202) 462-1001  
Internet: www.fda.gov  
E-mail: [publicaffairs@fda.gov](mailto:publicaffairs@fda.gov)

**Contents – Line Units**

**3603 Terminal Attachment Unit  
Loop Repeater (PN 4400002)**

**LINE UNITS**

This page precedes the 3603 Terminal Attachment Unit contents page.



1. Name of the Party  
2. Address of the Party  
3. Date of the Party

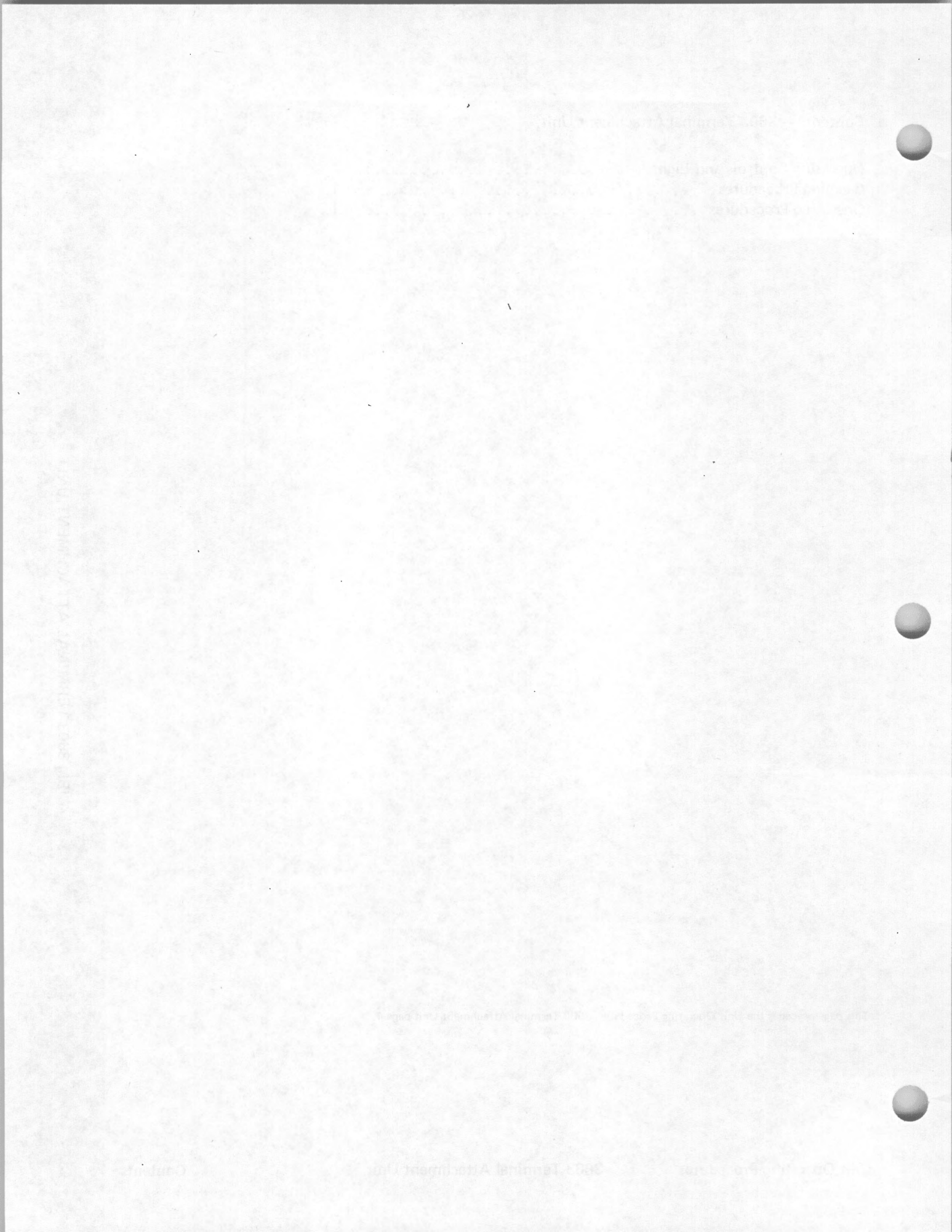


**Contents – 3603 Terminal Attachment Unit**

|                                     |   |
|-------------------------------------|---|
| Operating Controls and Lights ..... | 1 |
| Cleaning Procedures .....           | 1 |
| Operating Procedures .....          | 1 |

**IBM 3603 TERMINAL ATTACHMENT UNIT**

This page precedes the Unit Operating Procedures, 3603 Terminal Attachment Unit page 1.



## IBM 3603 Terminal Attachment Unit

The 3603, available in three models, adds to the flexibility of the 3600 system by allowing:

1. Any 3600 system terminal to be remote from the controller and independent of all other terminals.
2. A subloop to be isolated from a remote loop without affecting the remote loop.
3. Use of the switched network for backup purposes (Model 1 only).

### OPERATING CONTROLS AND LIGHTS

The operating controls and lights on the 3603 are for test and backup purposes only; they are not used during normal operations.

**Note:** *The WRAP UNIT-NORMAL-WRAP UNIT/LOOP switch should be maintained in the NORMAL position.*

### CLEANING PROCEDURES

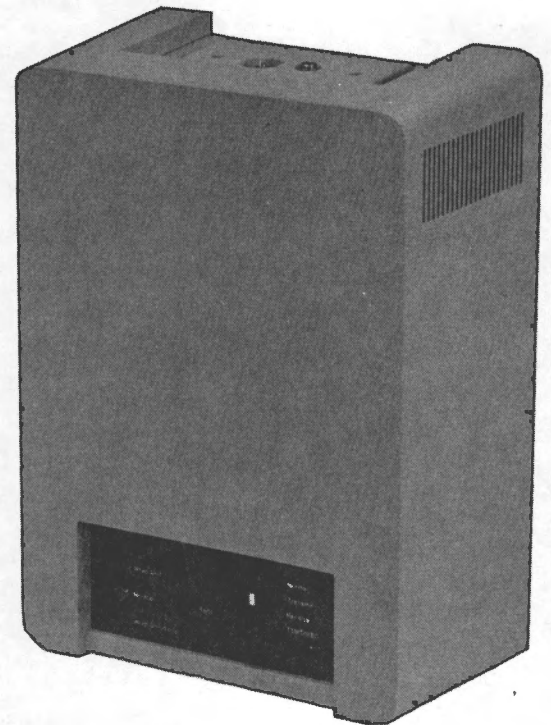
To clean the cover, use warm water and a mild detergent.

### OPERATING PROCEDURES.

The controls are to be used only when directed by the installation and maintenance procedures. These procedures are part of the Problem Recovery Procedures in this manual and the *3600 Financial Services Terminals: Terminal Installation Guide, GA27-2796*.

### CAUTIONS:

1. The WRAP UNIT-NORMAL-WRAP UNIT/LOOP switch has a locking feature to prevent its setting from being accidentally changed. To change the setting, it is necessary to pull outward on the handle to unlock it before attempting to reset it.
2. Unplugging the main power cord will cause the loop that the 3603 is part of to fail for as long as the 3603 is without power.



3603-1



The 3600 attachment unit is designed to be flexible and adaptable to a wide variety of systems.

Any 3600 attachment unit is designed to be compatible with all of the systems listed in the manual. A list of the systems is included in the manual. The 3600 attachment unit is designed to be compatible with all of the systems listed in the manual.

### OPERATING CONTROLS AND INDICATORS

The operating controls and indicators are located on the front panel of the 3600 attachment unit. The controls are used to operate the 3600 attachment unit.

The 3600 attachment unit is designed to be compatible with all of the systems listed in the manual. A list of the systems is included in the manual.

### CLEARING PROCEDURES

To clear the 3600 attachment unit, follow the following procedure:

### OPERATING PROCEDURES

The 3600 attachment unit is designed to be compatible with all of the systems listed in the manual. A list of the systems is included in the manual. The 3600 attachment unit is designed to be compatible with all of the systems listed in the manual.

### CAUTIONS

The 3600 attachment unit is designed to be compatible with all of the systems listed in the manual. A list of the systems is included in the manual. The 3600 attachment unit is designed to be compatible with all of the systems listed in the manual.

**Contents – Loop Repeater (PN 4400002)**

Operating Controls and Lights ..... 1  
Cleaning Procedures ..... 1

This page precedes the Unit Operating Procedures, Loop Repeater page 1.

10/11/2004 10:11:11 AM

The following is the list of cleaning procedures for Loop Repair (page 1)

## **IBM Loop Repeater (PN 4400002)**

The Loop Repeater permits longer loop cable runs between terminals. It may be part of a local loop or remote subloop.

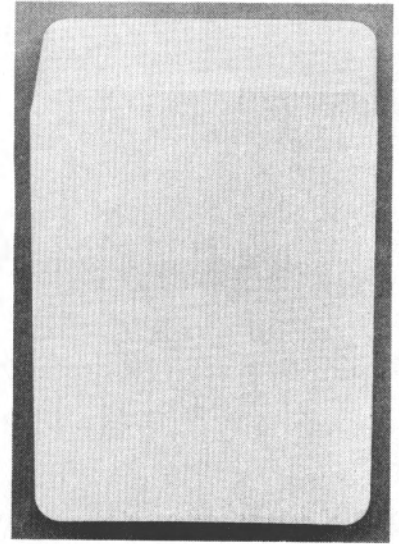
### **OPERATING CONTROLS AND LIGHTS**

There are no operating controls and lights.

### **CLEANING PROCEDURES**

To clean the cover, use warm water and a mild detergent.

**CAUTION:** Unplugging the main power cord causes the loop the Loop Repeater is part of to fail for as long as the Loop Repeater is without power.





The loop reference permits for a loop cable run between  
terminals. It may be used for a loop or for a cable loop.

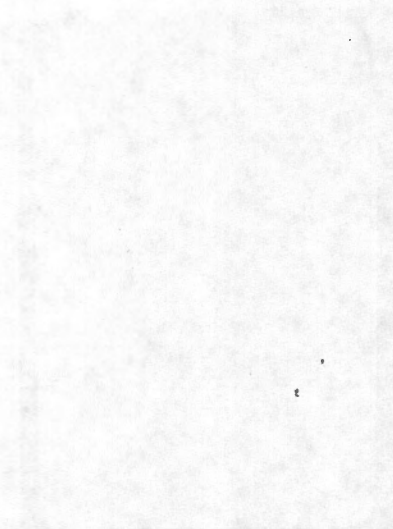
### OPERATING CONTROL AND LIGHTS

There are no operating controls and lights.

### CLEANING PROCEDURES

To clean the cover, use water with a mild detergent.

**CAUTION:** Wiping the main power cord can cause fire  
from the foot. Use a dry cloth to clean the foot.  
Do not use a solvent or other liquid.



Place all General Operating Procedures pages after this tab.

## **Contents – General Operating Procedures**

Basic Commands

Messages

Startup, Logon, and Logoff

    Startup of the 3600 System

    Startup Errors

    Logon and Logoff

Component Testing

    Assigning the Component to be Tested

    Changing Operating Parameters of Assigned  
    Test Component

This page follows the General Operating Procedures tab.





This page precedes the General Operating Procedures, Basic Commands page 1.



## Basic Commands

You communicate with the controller by entering commands at the "control operator 3604." You log on the 3604 by pressing the RESET (as defined by your institution's translation table) key three times.

Listed in the following table are the basic or most commonly used commands. They should be all you need for the basic operation of the system. A list of the entire set of commands, with a full description of their meaning, is in "Complete Commands" under "System Operating Procedures."

When using the commands, keep in mind the following points:

1. As soon as you press the 3604 RESET key three times, the universal translation table is in effect. While logged on, you can use the NK (return to normal keyboard) key or command 045 to return to your normal application program translation table.

**Note:** *When the universal translation table is in effect, some of the other keys may still be active.*

2. Most of the 3-digit command codes are followed by groups of letters that represent information you must specify to perform the function. For example:

```
021 ZZZ AAA BBB
046 XXXX YYYY
069 XY
```

The numerical command code and the groups of letters that follow are called *fields*. In this guide the fields are separated by a space, and *you must enter a space between fields*. Leading zeros (zeros entered at the start of a field to give the proper number of characters) are not required in any field except for the command codes and the SS part of the LSSDD field in commands 006, 007, and 010.

3. Enter the fields of a command in decimal unless noted to use hexadecimal.
4. You have the option of assigning a component as an output printer (see 006 command). You may use the output printer to get a printed copy of controller log messages (046 command) and statistical counters (012 command). Also, you may use the output printer for a printed record of all keyboard commands and display messages (command 061).

5. When you are logged on using the operating diskette, all output is translated using your institution-generated output translation tables. The output translation table must include all of the universal translation table characters plus \*, —, and T. If all of these characters are not available, translate checks may occur when messages containing these characters are displayed or printed. On the starter diskette, only one output translation table is used. That translation table does not translate correctly when using a 3610 or 3612 printer that has a 128-character print wheel (available in Japan only); therefore these printers should not be used as the output printer.
6. If the controller detects an error while you are logged on, it displays a five-digit error message that begins with a 9. These five digits are followed by four hexadecimal characters that are the two status bytes of the component associated with the error. If 0000 status is displayed, no status has been reported or none is associated with the error. Refer to "Messages" for an explanation of the error messages and the status bytes.



## Basic Commands

| Command   | Meaning   |
|---|---|
| <b>000</b>  | Log off. All special conditions, except those set by the 005, 043, 048, 049, 070, 071, 090 commands, are reset.   |
| <b>001 XXXX</b>   | Display message XXXX and up to 15 prior messages. Each time the EM (enter) key is pressed, the next most-recent message group is displayed; that is, the log is paged backward.   |
| <b>002 XXXX</b><br>XXXX = log message number.   | Display the text of log message XXXX (a maximum of 240 characters are displayed).   |
| <b>002 0000 (002 0)</b>   | Display the current diskette status. Two status bytes, XXXX, appear on the next line.   |
| <b>002 9999</b>   | Display the last log message written that turned on the Log Message light.  |
| <b>006 LSSDD X</b><br><br>L = loop number (1–8)<br>SS = terminal address (0–15)<br>DD = component address, as follows (leading 0 is not required):<br>1 = 3604 keyboard<br>2* = 3604 display<br>3 = magnetic stripe encoder<br>4* = 3610 or 3612 document printer or 3618 printer<br>5 = 3611 or 3612 passbook printer<br>6 = 3606 or 3608 keyboard, display, and magnetic stripe reader<br>7 = 3608 printer<br>8 = 3614 terminal<br>X = 0 for A-side or 1 for B-side.<br>If X is not entered, or does not equal 1, the A side is used. | Assign the specified component as the output printer.<br><br>The 3610 or 3612 document printer, or 3618, when assigned as the output printer, must have continuous forms mode set and have paper wide enough for an 80-character print line. If not, errors will occur.<br><br>If only 006 is entered, the component is reassigned to its work station; however, the hard copy function is not stopped. |

\*Only components that should be assigned as an output printer.

Basic Commands (cont.)

| Command  | Meaning   |
|--|---|
| <p><b>007 LSSDD X</b></p> <p>LSSDD X is the same as for the 006 command.</p>   | <p>Assign the component (or a terminal group component, identified by the 009 command) as the test component. The terminal group component subaddress is set to 0.</p>      |
| <p><b>009 XX</b></p> <p>XX = subaddress (0–15)</p> <p>If the entry is accepted, the terminal address (assigned by the 007 command) is displayed in hexadecimal on the next line. If 0000 is displayed, no test component was assigned.</p>   | <p>Assigns a subaddress to the test component in the terminal group specified by the 007 command.</p>   |
| <p><b>010 LSSDD</b></p> <p>L = loop number (1–8)<br/> SS = terminal address (0–15)<br/> DD = component address, as follows (leading 0 is not required):</p> <ul style="list-style-type: none"> <li>1 = 3604 keyboard</li> <li>2 = 3604 display</li> <li>3 = magnetic stripe encoder</li> <li>4 = 3610 or 3612 document printer or 3618 printer</li> <li>5 = 3611 or 3612 passbook printer</li> <li>6 = 3606 or 3608 keyboard, display, and magnetic stripe reader</li> <li>7 = 3608 printer</li> <li>8 = 3614 terminal</li> </ul> <p>LSSDD = 9001 for host link<br/> LSSDD = 9002 for diskette<br/> LSSDD = 9010 for disk file<br/> LSSDD = X000 for loop control, where X is the number of the loop.</p> <p><i>(continued on next page)</i></p> | <p>Display the statistical counters for the specified component.</p> <p>For detailed information on the statistical counters, see "Display/Print Statistical Counters."</p> |

Basic Commands (cont.)

| Command  | Meaning  |
|--|--|
| <p><b>010 LSSD (cont)</b></p> <p>The output format is:<br/> LSDM TT SS XXX XXX XXX . . . . .</p> <p>L = loop number (1–8)<br/> S = terminal address in hexadecimal<br/> D = component address in hexadecimal<br/> M = modulus value for a terminal component, or the speed of a loop (see below).<br/> TT = component type (see below)<br/> SS = work station identification (not applicable for host link, diskette, or loop control).<br/> XXX = count in decimal<br/> LSDM = 9010 for host link<br/> LSDM = 9020 for diskette<br/> LSDM = 9100 for disk file<br/> LSDM = X0YY for loop control, where X is the number of the loop.</p> <p>If YY = loop speed, the values are as follows:<br/> 01 = 4800 bps<br/> 02 = 2400 bps<br/> 04 = 1200 bps<br/> 08 = 600 bps<br/> 8X = this loop is used for clocking</p> <p>Component types (TT) are as follows:<br/> 01 = host link<br/> 02 = diskette or disk file<br/> 80 = loop control<br/> 81 = 3604 keyboard<br/> 82 = 3604 display<br/> 83 = 3610, 3611, or 3612 printer<br/> 85 = 3618 printer<br/> 86 = magnetic stripe encoder<br/> 87 = 3614 terminal<br/> 88 = 3606 or 3608 keyboard, display, and magnetic stripe reader<br/> 89 = 3608 printer</p> |  |
| <p><b>012 X</b></p> <p>X = number of loops attached to the controller.<br/> The output format is the same as for the 010 command.</p>  | <p>Print the statistical counters for all components on the assigned output printer (see the 006 command).</p> |

Basic Commands (cont.)

| Command  | Meaning   |
|--|---|
| <p><b>020 ZZZ YYY AAA BBB</b></p> <p>ZZZ = number of times to run the test. If 000 (0) is entered, the printing/display is continuous until the RE (reset) key is pressed twice.</p> <p>YYY = length of line to be printed/displayed (255 maximum).</p> <p>AAA = decimal number that gives the start position.</p> <p>BBB = decimal number that similarly identifies the end position.</p>                               | <p>Do a ripple print or display on the assigned test component.</p>   |
| <p><b>021 ZZZ AAA BBB</b></p> <p>ZZZ = AAA and BBB are the same as for 020, above.</p>   | <p>On the assigned test component, print/display the group of characters identified by AAA and BBB the number of times specified by ZZZ.</p>  |
| <p><b>023 ZZZ YYY AAA BBB</b></p> <p>ZZZ, YYY, AAA, and BBB are the same as for 020, above.</p>  | <p>Print/display a test pattern on the test component. The pattern will be a repetition of the two characters represented by AAA and BBB. AAA and BBB can be the same number.</p>   |
| <p><b>024 ZZZ X</b></p> <p>ZZZ = number of times to run the test. If 000 (0) is entered, reading is continuous until the RE (reset) key on the "control operator 3604" is pressed twice and the EM (enter) key on the test component is pressed or the RE (reset) key on the test component is pressed twice.</p> <p>X = 0 for decimal (EBCDIC) display of the input; 1 for hexadecimal display of the input.</p>        | <p>Read data (a maximum of 128 characters) from an input test component (3604, 3606, or 3608) and display the data on the "control operator 3604" in hexadecimal or decimal.</p> <p>Use the 062 command to specify the exception conditions to be displayed or ignored.</p> |
| <p><b>025 ZZZ TEXT</b></p> <p>ZZZ = number of times to run the test. If 000 (0) is entered, the output is continuous until the RE (reset) key is pressed twice.</p> <p>TEXT = any character available in the active keyboard input translation table. The character X is used to indicate that the data following the X and up to the next X or EM (enter) is hexadecimal data. To put an X in the output, enter XX.</p> | <p>Print/display TEXT to the test component. The TEXT can be all text, all hexadecimal data, or a combination.</p>  |



Basic Commands (cont.)

| Command   | Meaning   |
|---|---|
| <p><b>040 X YY ZZ CC</b><br/>                     X = 0 to start loops; 1 to stop loops only if in error recovery.<br/>                     YY ZZ CC, as a group, are optional.*<br/>                     YY = one or two hexadecimal characters for the first flag byte in the parameter list, as follows:<br/>                         08 = start/stop loop number CC. The stop is in effect only if the loop is in error recovery.<br/>                         02**= loop CC does not have a modem, or it has a nonwrappable modem.<br/>                         03**= loop CC has a wrappable modem.<br/>                     ZZ = 00.<br/>                     CC = number of the loop to be started or tested.</p> | <p>Start loops that are stopped, or stop loops if the loop is in error recovery. If YY ZZ are not entered, all loops that are stopped are started or all loops in error recovery are stopped. By entering YY ZZ CC, an individual loop is assigned for testing. The command that assigns a new test loop will stop the current test loop (a loop other than loop 1). To start the new test loop, 040 0 must then be entered. See "Component Testing."</p> |

\*If these bytes are not entered, the start or stop loop parameter list is set to 0, and the command applies to all loops. If they are entered, the parameter list values so entered remain in effect until changed by another 040 command, or until the next load.

\*\*Starter diskette only. These values change the second loop to the type and number specified.

Basic Commands (cont.)

| Command  | Meaning   |
|--|---|
| <p><b>041 X YY ZZ CC XFF AAAAA</b></p> <p>X = 0 to start link; 1 to stop link.</p> <p>If CC is specified, YY and ZZ must be entered.</p> <p><i>If CC and/or AAAAA is entered, YY and ZZ must be entered; if AAAAA is entered, XFF is not required.</i></p> <p>YY, ZZ, CC, XFF, and AAAAA are valid only on a start (041 0). If they are entered on a stop (041 1), they are ignored.</p> <p>YY* = one or two hexadecimal characters for the first flag byte in the parameter list, as follows:</p> <ul style="list-style-type: none"> <li>01 = NRZI encoding</li> <li>02 = non-NRZI encoding</li> <li>04 = nonwrappable modem</li> <li>08 = Wrappable modem</li> <li>10 = high-speed line**</li> <li>20 = low-speed line**</li> <li>40 = not-select standby</li> <li>80 = select standby</li> </ul> <p>ZZ* = one or two hexadecimal characters for the second flag byte in the parameter list as follows:</p> <ul style="list-style-type: none"> <li>01 = control request to send</li> <li>02 = permanent request to send</li> <li>04 = data set ready</li> <li>08 = connect data set to line</li> <li>10 = <i>nonswitched line</i></li> <li>20 = <i>switched line†</i></li> <li>40 = <i>extended command indicator</i></li> <li>80 = <i>an entry for CC follows</i></li> </ul> <p>CC = One or two hexadecimal characters for the control unit address (CUA).</p> <p><i>XFF* = one or two hexadecimal characters for the third flag byte in the parameter list. The character X is required and must be entered if FF is entered. The FF hexadecimal characters have the following meaning:</i></p> <ul style="list-style-type: none"> <li><i>80 = XID follows</i></li> <li><i>01 to 40 = reserved</i></li> </ul> <p><i>AAAAA = the five hexadecimal character identification assigned to the particular controller.</i></p> | <p>Start the host communication link if it is stopped, or stop the link if the link is in error recovery.</p> <p>If 041 is entered while the link is running, the link parameters will not take effect until the link is stopped.</p> |

\* If these bytes are 0 or are not entered, the link parameters remain unchanged. If they are entered, the values so entered remain in effect until changed by another 041 command or until the next load.

\*\* Normally, modems are capable of operating at two speeds. These values identify the speed to be used.

† If 20 is entered, 02 is ignored.

**Note:** *The italicized information applies only in a switched link installation; for nonswitched links, ignore the italics.*

Basic Commands (cont.)

| Command   | Meaning  |
|---|--|
| <p><b>043 FF XX XX XX XX XX</b></p> <p>FF = one or two hexadecimal characters for the flag byte in the parameter list.</p> <p>XX = one or two hexadecimal characters of a parameter data byte.</p> <p>The number of parameter data bytes varies from component to component. You must enter all the data bytes for a given component.</p> <p>Refer to "Changing Operating Parameters of Assigned Test Component" under "Component Testing."</p> | <p>Change the operating parameters of the assigned test component. The parameters set up by this command remain in effect until changed by another 043 command or until a load again sets up the original configuration parameters.</p>  |
| <p><b>044 TEXT</b></p> <p>TEXT must be numeric or letters C, D, or E.</p> <p>C = end of inquiry character</p> <p>D = field separator character</p> <p>E = unassigned, available for user</p> <p>The maximum number of characters in TEXT is 36.</p>   | <p>Write TEXT on the magnetic stripe encoder. The encoder must be assigned as the test component (007 command), even if it is on the 3604 currently being used as the "control operator 3604."</p> <p>Although this test was meant for the encoder, it can be used for any printer or display assigned by the 007 command.</p> |
| <p><b>046 XXXX YYYY</b></p>   | <p>Print controller log messages numbered XXXX through YYYY on the output printer assigned by the 006 command.</p>   |
| <p><b>046 0001 9999</b></p>   | <p>Print all controller log messages on the assigned output printer.</p>   |
| <p><b>061 X</b></p> <p>X = 0 for no hard copy; 1 for hard copy.</p>   | <p>Provide a hard copy of all keyboard and display messages on the assigned output printer (see the 006 command).</p>  |

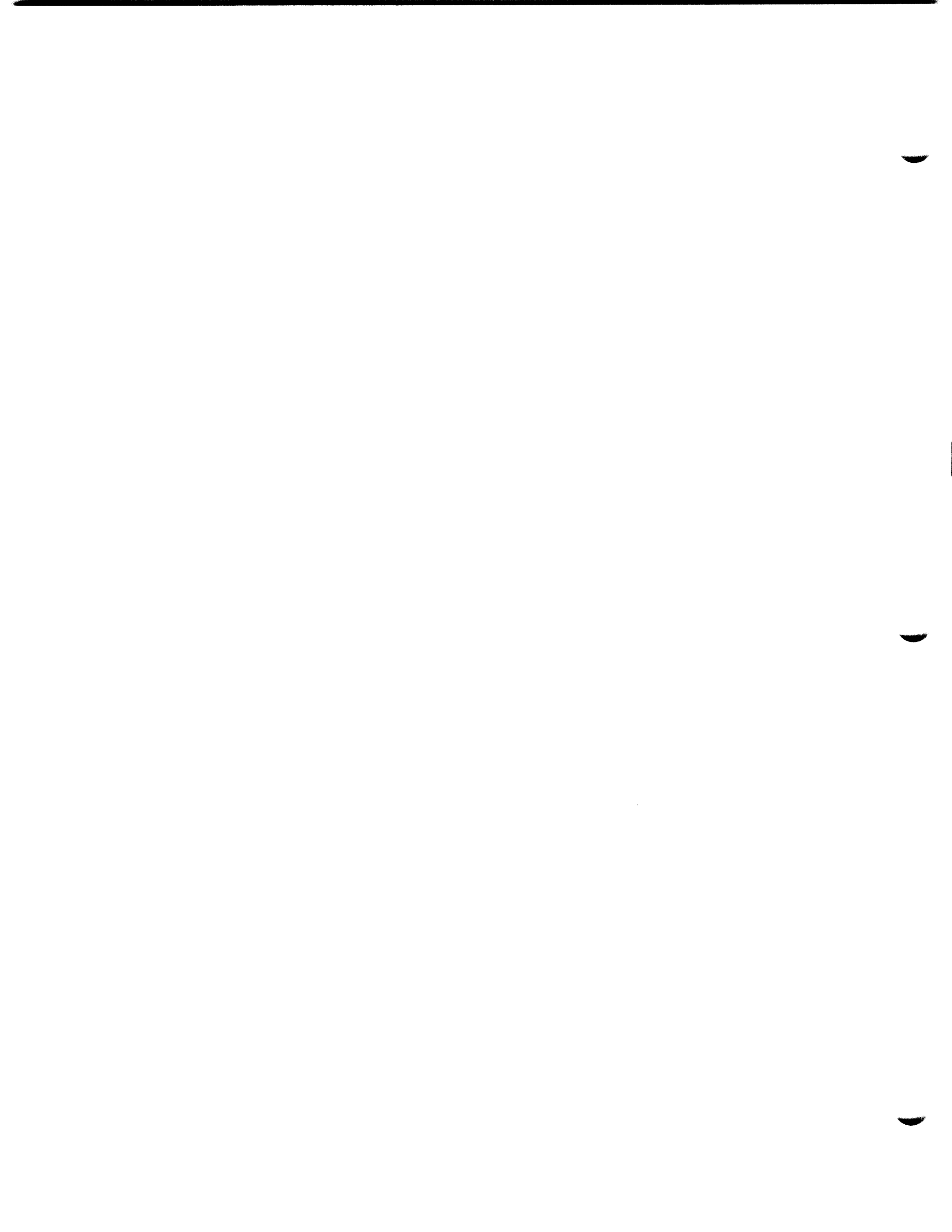
Basic Commands (cont.)

| Command   | Meaning   |
|---|---|
| <p><b>062 X YY</b></p> <p>X = 0 to terminate the test and to display exception status; 1 to try to continue the test ignoring exception status YY.</p> <p>YY specifies errors or exception condition to be ignored:</p> <ul style="list-style-type: none"> <li>80 = intervention required</li> <li>40 = unit exception</li> <li>10 = prior operation</li> <li>02 = unit check</li> <li>FF = all of above</li> </ul> <p>Until any 062 command is issued, intervention required, unit exception, and prior operation are ignored.</p> | <p>Ignore error conditions specified during read (024 command) or write operations to test components. To obtain status as soon as any error condition(s) or exception condition(s) are detected, key and enter 062 0 and then run the test again.</p> <p>If you want the controller to ignore specific errors or exception conditions during a test, key and enter 062 1 YY and then run the test (where YY is the conditions to ignore).</p> <p>When running a test with Unit Check ignored, there is a possibility that the number of lines printed will not equal the number requested. This depends upon when the Unit Check is encountered.</p> |
| <p><b>066</b></p>   | <p>This command is used when cleaning the print wheels on the 3610, 3611, and 3612 printers. It causes the printer to print 128 characters on each line, in 16 character positions, for 20 lines or until the end of the form or passbook is reached. See "Cleaning the Print Wheel" in the applicable printer operating procedure.</p>   |
| <p><b>069 XY</b></p> <p>X = 0 to turn off the lights; 8 to turn on the lights.</p> <p>Y = 1, 2, 4, or 8 to identify the light labeled 1, 2, 3, or 4 respectively, or Y = 3, 5, 6, 7, or 9 through F to identify a combination of lights whose individual values add up to Y. For example, 6 would indicate lights 2 and 3.</p> <p>XY = FF to turn on the CHECK light of the 3604 at which the control operator has logged on. To turn off this light, press the RE (reset) key one time.</p>  | <p>Turn on/off the lights on the test component, or turn on the CHECK light of the 3604 at which the control operator has logged on.</p> <p><b>Note:</b> <i>Some 3604s may have an audible alarm associated with one or more of these lights.</i></p>   |



MESSAGES

This page precedes the General Operating Procedures, Messages page 1.



## Messages

The controller communicates with you by displaying the messages described in the table below.

All 7XXXX and 82XXX messages are displayed only on the 3604 at address 1 on loop 1. All require operator action, with the possible exception of 82000 (see below). If enough of the system has been loaded, the 82XXX message will be followed by an 82060 message which is the system dump request. (The 82060 will appear in the first five character positions of the display; the 82XXX message will remain displayed. See message 82060 for details.) A dump is a copy of the information in storage. When this occurs, you must reload the system after the dump. If a dump is not required, press the controller RESET switch to reload the system.

**CAUTION:** Any time another diskette is going to be inserted after an 82XXX message and a dump is not required, the following sequence should be adhered to:

1. Open the door to the diskette drive.
2. Insert the new diskette.
3. Press the RESET switch on the controller.
4. Close the door to the diskette drive.

**Failure to follow this sequence may cause a dump to be started, thereby possibly destroying valid data on the diskette just inserted.**

Most of the messages are accompanied by two status bytes, displayed as four hexadecimal characters, that give the status of the terminal component connected with the error. Byte 1 (characters 1 and 2) has general meaning not specific to any component. The specific information is contained in byte 2 (characters 3 and 4). The meaning of the individual bits of byte 1 is as follows:

| <i>Character</i> | <i>Bit Meaning</i>  |
|------------------|---|
| First            | 8 = intervention required<br>4 = unit exception<br>2 = data check<br>1 = status is for a prior write operation combined with any residual status. The current write status is lost.<br>Not used by the host link. |
| Second           | 8 = the operation was ended by an attention [pressing the RE (reset) key twice on the 3604]<br>4 = command reject<br>2 = unit check (loss of contact on host link)<br>1 = wrong-length record                     |

Note that more than one bit of a status character can be activated at the same time. If this occurs, the displayed character is the sum of the active bits. For example, a displayed first status byte of 63 indicates that bits 4 and 2 of the first status character and bits 2 and 1 of the second status character are activated. (Similarly, more than one bit of status characters 3 and 4 can be activated simultaneously.)

For a detailed explanation of the status by component type, refer to the *IBM 3600 Finance Communication System Instructions and Macros Reference*, GC27-0003.

#### Messages

| Message   | Meaning  | Action  |
|---|--|---|
| 00001   | The controller is requesting the control operator to enter one of the startup codes to specify the type of startup. If no key is pressed within the predefined timeout period, an automatic startup is done. | Enter the response; see "Startup of the 3600 System" for valid responses. |
| 00002<br>to<br>00006  | The controller is requesting the control operator to enter information during a prompt mode startup. See "Startup of the 3600 System".   | Enter the requested information (normal operation).                       |
| 00010<br>00012<br>to<br>00015<br>00020<br>00030<br>00032<br>00034<br>00036<br>00038 | The controller is requesting the control operator to insert a diskette in the controller or to enter information when creating a diskette. See "Create Diskette."  | Enter the requested information (manual operation).                       |
| 00040<br>00041  | Prompt messages that may result from a move system track request command (094).  | See 094 command for valid responses.                                      |
| 00090<br>to<br>00093<br>00099   | The controller is requesting the control operator to insert a diskette in the controller or to enter information when transmitting a diskette. See "Transmit Diskette."                                      | Enter the requested information (manual operation).                       |
| 70001<br>to<br>70003  | The controller is requesting the control operator to insert a diskette in the controller or to enter information when formatting a diskette. See "Diskette Formatting."                                      | Enter the requested information (manual operation).                       |



Messages (cont.)

| Message                                | Meaning  | Action  |
|--|--|---|
| 70000<br>70090<br>72000<br>to<br>72090 | See "Diskette Formatting," Error Messages.               | (The action for the 70000 message is the same as for the 82000 message.)  |
| 82000                                  | Controller error.  | If the dump option was not specified, the system will attempt an automatic warm start. Operator intervention is not required. If this error should occur 16 times, the 82020 message will appear, and operator action is required to reload the system. If the dump option was requested, the 82060 message will appear. (See message 82060 for action.) Reload the system, and, if the message occurs again, call the service representative and report the displayed message. |
| 82001                                  | Machine or program check occurred during system loading. | Start up again (reset); if the error occurs again, follow the 82XXX common procedure.*  |
| 82011                                  | The control program extent data is invalid.              | Start up again (reset) with another diskette. If the error still occurs, follow the 82XXX common procedure.*  |
| 82012                                  | The link package extent data is invalid.                 | Same as 82011   |
| 82013                                  | The optional module extent data is invalid.              | Same as 82011.  |
| 82014                                  | CPGEN extent data is invalid.                            | Same as 82011.  |
| 82017                                  | AP or system monitor extent data is invalid.             | Same as 82011.  |
| 82020                                  | Automatic system load failed 16 times.                   | Same as 82011.  |
| 82021                                  | Diskette label read error.                               | Same as 82011.  |
| 82022                                  | Diskette label write error.                              | <ol style="list-style-type: none"> <li>1. If the diskette is stopped, enter a start diskette command (042 0).</li> <li>2. Make sure the diskette drive door is closed and the proper diskette is inserted.</li> <li>3. If an invalid record had been requested (status 0480), enter the command again with the correct track and record number.</li> <li>4. If the read operation was for a control record (status 0204), the requested record is not there.</li> </ol>         |

\*(See note after 82092 message.)

Messages (cont.)

| Message | Meaning  | Action  |
|---------|--|---|
| 82031   | Insufficient storage to load control program.  | Insert the starter diskette. If the error occurs again, there is a control storage problem; follow the 82XXX common procedure.* If the starter diskette loads without error, create a new operational diskette. |
| 82032   | Insufficient storage to load link modules.   | Same as 82031.  |
| 82033   | Insufficient storage to load optional modules.   | Selectively load optional modules or add control storage.   |
| 82034   | Insufficient storage to load CPGEN.  | Decrease CPGEN size or add user storage.  |
| 82035   | Insufficient storage to load AP constant section.  | Decrease AP size or add user storage.   |
| 82036   | Insufficient storage to load AP instruction section.   | Same as 82035.  |
| 82037   | Insufficient storage to load dummy AP.   | Same as 82035.  |
| 82041   | Hash error in control program.   | Same as 82011.  |
| 82042   | Hash error in link modules.  | Same as 82011.  |
| 82043   | Hash error in optional modules.  | Same as 82011.  |
| 82046   | Hash error in system monitor.  | Same as 82011.  |
| 82050   | Diskette initialization or 3600 label read error.  | Same as 82011.  |
| 82051   | Control program diskette read error.   | Same as 82011.  |
| 82052   | Link module diskette read error.   | Same as 82011.  |
| 82053   | Optional module diskette read error.   | Same as 82011.  |
| 82054   | CPGEN diskette read error.   | Same as 82011.  |
| 82056   | AP diskette read error.  | Same as 82011.  |
| 82057   | Error map diskette read error.   | Same as 82011.  |
| 82058   | Diskette error during warm start.  | Same as 82011.  |
| 82060   | Insert a 3600-formatted diskette that can be used for the dump or open and close the door to the diskette drive if the dump is to be written on the current diskette. Any diskette that the dump was written on can no longer be loaded. | Opening and then closing the diskette drive door will cause the 82066 message to appear. If a dump is not required, press the RESET switch on the controller to reload the system.                              |
| 82061   | The dump is complete; this message replaces the 82066 on the display.  | Remove the diskette and notify the service representative.  |
| 82062   | Mount another diskette for second part of dump.  | Opening and then closing the diskette drive door will cause the dump to continue.   |

\*(See note after 82082 message.)

Messages (cont.)

| Message | Meaning  | Action  |
|---------|--|---|
| 82066   | This message replaces the 82060 message after the diskette for the dump has been inserted in the diskette drive, but before the dump is written on it. | If the correct diskette has been inserted in the diskette drive, open and then close the diskette drive door for a second time to cause the dump to be taken.<br><b>Note:</b> <i>If the incorrect diskette had been inserted, replace it with the proper one when opening and closing the diskette drive door for the second time. If you decide to not take the dump, press the RESET switch on the controller to reload the system.</i> |
| 82070   | AP section length is zero.   | Reassemble the AP.  |
| 82071   | Total AP length is less than the sum of its parts.   | Same as 82070.  |
| 82072   | Total AP length is greater than the sum of its parts.  | Same as 82070.  |
| 82073   | End of the extent, but not of the AP.  | Same as 82070.  |
| 82074   | End of system monitor, but not of the extent.  | Same as 82070.  |
| 82075   | ROD length error.  | Same as 82070.  |
| 82076   | ROD format error.  | Same as 82070.  |
| 82077   | Link module length error.  | Recreate the operational diskette.  |
| 82078   | An optional module contains invalid information.   | Start up again and enter the correct optional module IDs. Verify that the correct operating diskette has been inserted. If the error still occurs, try the starter diskette, requesting the same optional module IDs. If the error does not occur, then the wrong diskette was inserted. If the error occurs again, follow the 82XXX common procedure.*   |
| 82082   | An attempt was made to load a diskette that had a dump written on it or that was written on using the 936 command.                                     | This diskette can be used for other dumps, but a new diskette must be created on it for it to be loaded.  |

\*Common procedure for the 82XXX messages:

When an 82XXX message, preceded by an 82060 message, appears, take a dump. If the 82060 message does not appear, the dump is not possible. In either case, call the service representative and report the displayed error message with as much information as possible about the action taken and the conditions preceding the error message. Save the diskette(s) that contain the dump.

Messages (cont.)

| Message | Meaning  | Action   |
|---------|--|--|
| 82092   | The configuration data does not have any 3604 defined.   | This diskette cannot be used. The configuration process must be redone and at least one 3604 must be defined.  |
| 90000   | This is a request for the control operator to enter the identification code during the logon procedure. It also appears during startup or create diskette prompting if attempting to change the identification code.                               | Enter the control operator ID code. If valid during the logon, 91111 will replace the 90000 message. If an error was made in keying or if an incorrect ID was entered, the display will go blank.<br><br>If valid during the prompting, the new control operator ID is accepted and replaces the current one. If invalid, the 00004 or 00034 message will be repeated. |
| 90001   | The control operator entered an invalid command (not-numeric, more or less than three characters, or not in the command code table) or an 032 command was issued to an operational diskette.   | Enter the command correctly.   |
| 90002   | An error was detected while reading a record from the diskette.  | Same as 82022.   |
| 90003   | An error was detected while reading the keyboard. If the error continues through two more keyboard entries, the control operator is automatically logged off. Also, this message appears when the RE (reset) key is pressed twice; status is 0800. | Reenter the command.   |
| 90004   | There is no X1 XXX-type message in the controller log if an 002 9999 command was issued or there are no messages in the log because a reset temporary file had been issued.  | None.  |



Messages (cont.)

| Message | Meaning   | Action  |
|---------|---|---|
| 90005   | An error was detected while writing to the display.   | If this is a recurring error, log off this 3604 via the 000 command. If this does not work, press the RE (reset) key six times. When the logoff is complete, log on to another 3604 and try to run the exerciser tests for the display that was used previously. If errors occur, call the service representative.  |
| 90006   | An operator keyboard error occurred when giving the log message number in a 002 or 046 command or when giving the track and record number of a read diskette command.   | Enter the command correctly.  |
| 90007   | A command has been given to print on the output printer and one of the following conditions was detected: (1) no output printer has been assigned, (2) an error occurred while printing, or (3) the optional module was not loaded for this terminal.   | <ol style="list-style-type: none"> <li>1. Assign an output printer if none was assigned via the 005 or 006 command.</li> <li>2. Determine the meaning of the status bytes. Try the operation again; if the error still occurs, reassign the printer via the 005 or 006 command and then assign it as the test component via the 007 command. Run exercisers; if errors still occur, call the service representative.</li> <li>3. The wrong diskette was inserted for this controller, or the optional module for this terminal was not included at startup time. Insert the correct diskette for this controller or request that the proper optional module be loaded.</li> </ol> |
| 90008   | A command has been given to a test component and one of the following conditions was detected: (1) No test component has been assigned, (2) an error was detected while using the test component, or (3) the optional module was not loaded for this terminal. Refer to "Startup of the 3600 System." | <ol style="list-style-type: none"> <li>1. Assign a test component if none was assigned by means of the 007 command.</li> <li>2. Determine the meaning of the status bytes connected with the test component. If errors continue, call the service representative.</li> <li>3. The wrong diskette was inserted for this controller, or the optional module for this terminal was not included at startup time.</li> </ol>  |
| 90009   | An operator keyboard error occurred: an invalid component address, station ID, or logical device address was keyed in, or the component is not in the system.   | Enter the command correctly. Verify that the component is defined in the configuration.   |

Messages (cont.)

| Message | Meaning   | Action  |
|---------|---|---|
| 90010   | An operator keyboard error occurred: invalid number of times to run test.   | Enter the command correctly.  |
| 90011   | An invalid test indicator lights command (069) has been given. Either the operator made a keyboard entry error or no test component has been assigned.  | <ol style="list-style-type: none"> <li>1. Enter the 069 command correctly.</li> <li>2. Assign the test component via the 007 command.</li> </ol>  |
| 90012   | An error was detected when writing to the diskette.   | Determine the meaning of the diskette status bytes. See 82022.  |
| 90013   | An invalid work station identification (ID) was entered with a 123 command. Either the operator made a keyboard entry error, or the work station was not included in the configuration procedure.   | <ol style="list-style-type: none"> <li>1. Enter the command correctly.</li> <li>2. Check the configuration list to determine if the work station was defined.</li> </ol>  |
| 90014   | <p>An error was detected while reading from the diskette.</p> <p><i>Note: Opening the door of the diskette drive causes the diskette to go not ready. When the door is closed, the diskette goes from the not ready condition to a logically stopped condition.</i></p> | <ol style="list-style-type: none"> <li>1. Make sure the diskette drive door is closed.</li> <li>2. If the diskette is logically stopped (see Note) make sure the correct diskette is inserted, and then give the start diskette command (042 0).</li> <li>3. Again enter the command that caused the error.</li> <li>4. If the error occurs again, try a new operating diskette and/or try a starter diskette.</li> </ol> |
| 90015   | The component requested as the output printer or test component (command 005, 006, 007, or 008) is busy and cannot be assigned.   | Make sure that the component is not busy and enter the command again, or else try another component.  |
| 90016   | An operator keyboard error occurred. This message is displayed when the error is not covered by any other message.  | Enter the command correctly.  |
| 90017   | An operator keyboard error occurred: invalid line length or a line length greater than that permitted for the test.   | Enter the command correctly.  |
| 90018   | No component has been assigned for the requested function.  | Assign a terminal component capable of performing the function requested.   |

Messages (cont.)

| Message | Meaning  | Action   |
|---------|--|--|
| 90019   | An operator keyboard error occurred: (1) attempted to assign the presently assigned test component as the output printer, or (2) attempted to assign the presently assigned output printer as the test component, or (3) attempted to assign components to or from the control operator by means of the 008 command. | Use another component for the function. If the component is correct, reassign it first with the 005 or 006 and 007 commands, and then assign it again with the 007 and 005 or 006 commands or the 008 command. |
| 90020   | An operator keyboard error occurred: the 3614 was not assigned as the test component and command 051, 052, or 053 was entered.   | Assign the appropriate component.  |
| 90021   | An error was detected when reading from the test component.  | Refer to the status bytes to identify the problem.   |
| 90022   | The echo message from the 3614 did not compare with the output test message.<br><br>The format of the 90022 error message is:<br>90022 XXX S . . . . S E . . . . E<br>XXX = counter<br>S . . . . S = data sent<br>E . . . . E = echo data  | Compare the displayed data sent with the displayed echo data. Try the test again. If the error persists, call the service representative.  |
| 90023   | The operator changed the diskette and gave a start diskette command (042 0).   | Either return the original diskette and retry the operation, or leave the second diskette inserted and start up again (reset).   |
| 90024   | Unexpected data was received from the 3614.<br><br>The format of the 90024 message is:<br>90024 - D . . . . D<br>D . . . . D = unexpected data received from the 3614  | Refer to the <i>3614 Operator's Guide</i> for the meaning of the data received.  |
| 90025   | Unable to reassign test component or output printer back to original owner.  | Start up again (reset). If the error continues to occur, notify the service representative.  |

Messages (cont.)

| Message | Meaning  | Action   |
|---------|--|--|
| 90026   | Unable to assign a component because the logical device address (LDA) requested already has a component assigned.                    | Startup again (reset) if 005 or 006 and 007 commands were issued. If the error continues to occur, notify the service representative. If the error resulted from a 008 command, the component that is assigned to the LDA must be removed before the new component can be assigned. The component can be removed by issuing a 008 command for that component. Now the 008 command can be issued for the new component. |
| 90027   | Error occurred during a disk file operation. This message can appear during startup or during normal operations.                     | <ol style="list-style-type: none"> <li>1. If occurred during startup, system was unable to move APs from the diskette to the disk file; notify the system programmer of this condition.</li> <li>2. If occurred during normal operations, the 09X command was not completed. Enter the command again; if it fails again, notify the service representative of this condition.</li> </ol>                               |
| 90028   | Error occurred when trying to replace a record in the disk file. This message can appear during startup or during normal operations. | Same as for 90027.   |
| 90029   | System was unable to allocate specified disk file tracks for APs. This message can appear during startup only.                       | The first available tracks were allocated and the APs moved to them; notify the system programmer of this condition.   |
| 90030   | A command was issued that required an optional module that was not loaded or was not available on the loaded diskette.               | Insert the correct diskette or restart the system (press RESET switch on controller) and press prompt mode during the startup to specify the required optional module ID.  |
| 90031   | Scheduling has been inhibited by another work station; refer to the 090–095 commands.  | Enter the command again. If scheduling is still inhibited, you may resume scheduling with the 090 command; however, care should be exercised since another workstation may be updating files and should not be interrupted.  |



Messages (cont.)

| Message        | Meaning  | Action  |
|----------------|--|---|
| 90032          | A read or write error occurred during programmable input mode operation.   | None.   |
| 90033          | Another work station is logged on in programmable input mode.  | None.   |
| 90034          | Link adapter wrap test failed.   | Try again. If the error still occurs, call the service representative.  |
| 90035          | Invalid 040 command, or 973 command failed because of invalid loop number or device type.  | Enter the command correctly.  |
| 90050          | The input received from the keyboard during startup is not valid: <ul style="list-style-type: none"> <li>● The control unit address (CUA) is not 1 or 2 characters.</li> <li>● The dump option response is not numeric or is more than one character.</li> <li>● The response to the 00001 message is not 0–9.</li> <li>● More than 16 optional module IDs were entered.</li> <li>● Automatic startup code is invalid.</li> <li>● The 7 XX response to the 00001 message was an invalid link module ID.</li> </ul> | Enter the correct response.   |
| 90051          | Unknown link adapter type (appears before 00001 message); no link module loaded or link requested (7 XX) does not match adapter in controller.   | Load proper link module or enter correct response.  |
| 90061 to 90066 | See "Transmit Diskette," Error Messages.   |   |
| 90071 to 90078 | See "Create Diskette," Error Messages.   |   |
| 90080 to 90088 | See "Debug Mode," Error Messages.  |   |
| 90099          | An error was detected in the system monitor function of the controller.<br>The format of the 90099 message is:<br>90099 XX YYYY<br>XX and YYYY are diagnostic data for engineering personnel.  | Start up again (reset) or try another operating diskette. If the error still occurs, call the service representative. |
| 91111          | The control operator identification is ok. Logon is complete. Control operator commands can now be entered.  | None.   |

Messages (cont.)

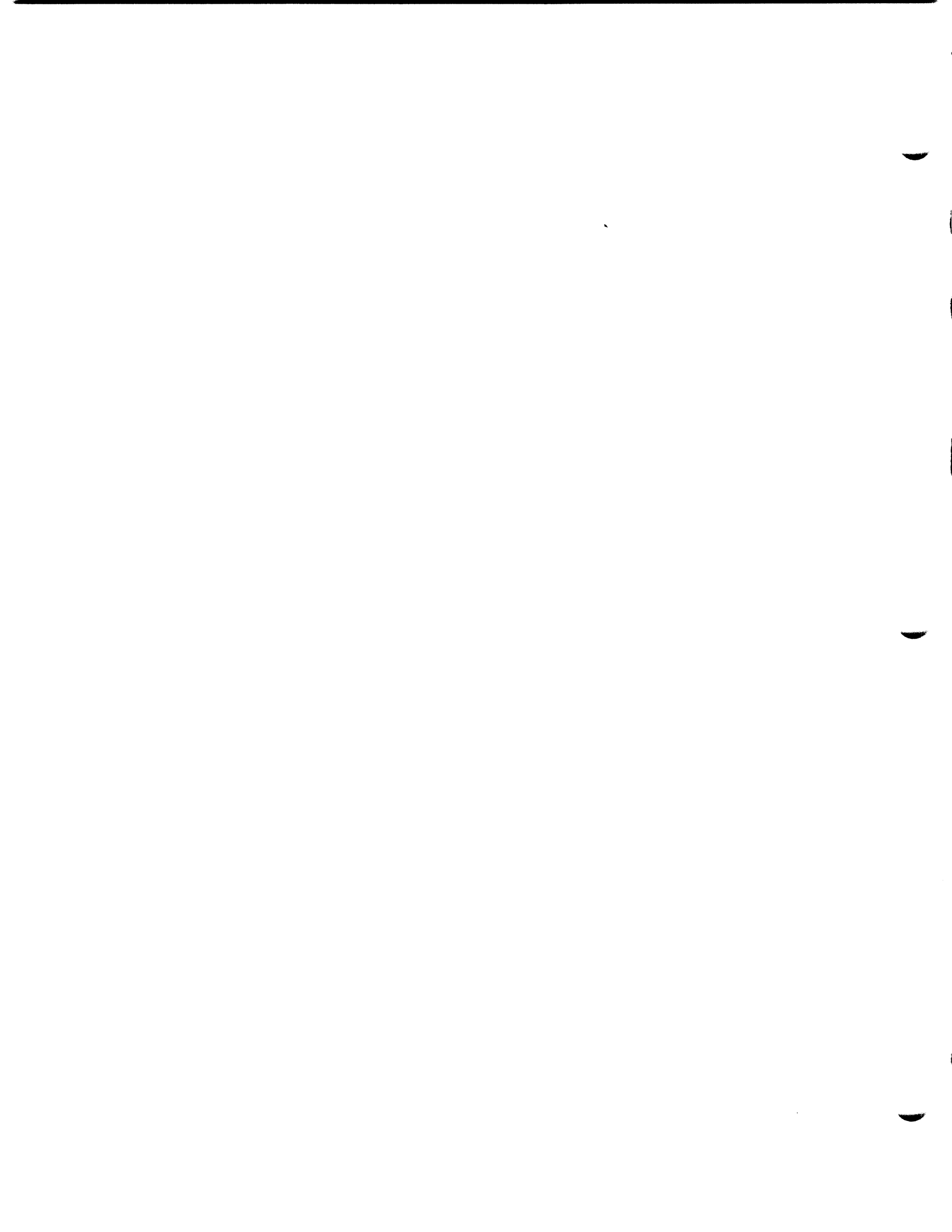
| Message                   | Meaning  | Action   |
|---------------------------|--|--|
| 92010                     | A diskette read error occurred during startup; the system is unable to continue processing.  | 1. Start up again (reset).<br>2. Try another operating diskette.<br>3. Try a starter diskette.<br><br>If the error still occurs, call the service representative.  |
| 92076 XX<br>XX XX . . . . | The module IDs displayed are invalid or are not available on the loaded diskette.<br><br>XX = invalid or not available module ID.                | Enter the EM (enter) key to continue the startup sequence if these modules are not required, or insert the correct diskette, press the RESET switch on the controller, and enter prompt mode during the startup to specify the correct optional module IDs. See 00005 message in "Startup of the 3600 System." |
| 92222                     | The automatic control operator logon is complete. This message appears only once on the starter diskette, immediately after startup is complete. | None.  |

## Contents – Startup, Logon, and Logoff

|                                      |   |
|--------------------------------------|---|
| Startup of the 3600 System . . . . . | 1 |
| Startup Errors . . . . .             | 6 |
| Logon and Logoff . . . . .           | 6 |

STARTUP, LOGON, AND LOGOFF

This page precedes the General Operating Procedures, Startup, Logon, and Logoff page 1.





## Startup, Logon, and Logoff

Generally, you start up the 3600 system whenever the controller has been turned off or whenever the operating diskette is replaced. When you start up, the controller is loaded from a diskette. The diskette will either be the one provided by IBM and shipped with each controller, called the *starter diskette*, or the one created by your financial institution, called the *operating diskette*.

The main function of the starter diskette is to allow your institution to create an operating diskette. (See "Create Diskette.") The starter diskette also has all the functions that can be performed with an operating diskette.

The operating diskette contains:

1. Your institution's configuration image: the information necessary to tailor the system to meet the needs of your institution.
2. The application programs provided by your institution that enable the controller and the terminals to perform the required transactions.
3. Your institution's permanent and temporary files.

The startup procedure is the same whether you are using an operating or starter diskette. When startup is complete using an operating diskette, the system monitor is logged off and control is given to your institution's application programs at their startup entry points, if specified. With the starter diskette, the system monitor is *not* logged off; startup is complete when message 92222 appears.

### STARTUP OF THE 3600 SYSTEM

After inserting the proper operating diskette, set the controller ON/OFF switch to ON (press the ON side), or press the RESET switch if power is already on. The resulting startup sequence is as follows:

1. **The controller performs a series of checkout procedures (diagnostic tests), to make sure that the controller is operating properly and that the proper diskette is being used, and then loads the data on the diskette into controller storage.**
2. **The 3604 at address 1 on loop 1 displays diagnostic test messages in the upper left corner of the display.**

Each message is displayed for a few seconds and is then replaced by the next message. The DTC message remains on the display while storage is being loaded.

**Note:** *It takes about 2 minutes for the controller to perform the diagnostic tests and to load the data on the diskette into storage. If, however, the controller cannot start a loop which has been correctly identified, the time to perform the load may be increased by from 30 seconds to 2 minutes.*

The diagnostic test messages are listed under "Startup Errors."

3. When loading is complete (except for optional modules), the "control operator 3604" erases the DTC message and then displays the startup message on the top two lines of the display.

The startup message, which indicates that the controller data has been successfully loaded from the diskette, is as follows:

```
CTL CODE ID VOLID GENID EC LEVEL CUA RELOCATE CT SESSION ID  
00001
```

- First Line of Display:

CTL CODE ID = control code supplemental version identification.

VOLID = volume identification (diskette identification).

GENID = configuration generation identification.

*Note: The CTL CODE ID, VOLID, and GENID identify the diskette and application program(s). Make sure that you are using the correct diskette and the correct level (not a back-level diskette).*

EC LEVEL = engineering change level of the controller data.

CUA = control unit address. The host computer addresses the controller by the CUA.

RELOCATE CT = relocate count, which is a count of the diskette records moved to the error track because of diskette surface defects. The maximum number of relocated records is 12.

*Note: If the count is more than 0, your institution should create a new diskette. Using this diskette causes additional diskette arm movement whenever the relocated records are accessed. Additionally, once the count reaches 12, permanent write errors may be encountered.*

SESSION ID = the number of cold starts and temporary file resets since the diskette was created; this ID is used to identify diskette records.

- **Second Line of Display:**  
00001 = a message requesting you to specify the type of startup you want. However, the type of startup may have been previously defined. In that case, the 00001 will be immediately erased and replaced by a prompt message (see the table of prompting messages below) or an error message (see "Messages"). If the 00001 was immediately erased, the startup is continuing and the first line of the display will go blank when the startup has been completed.

**Note:** *If no key is pressed within a time-out period [defined during the configuration generation process (preset to 2 minutes on the starter diskette)], an automatic startup occurs.*

**4. Key and enter the correct digit or digits in response to the 00001 message.**

- 0 XX= load utility module XX; applies only with starter diskette.  
XX = 70 for diskette format service program.
- 1 = cold start.
- 2 = warm start. If no other startup has been defined or entered, this is the automatic default startup type.
- 3 = diagnostic loop. The diagnostic tests mentioned in step 1 are repeated until you press the controller RESET switch.
- 4 = prompt mode. The controller asks or "prompts" you if you want to change the CUA, enter a dump option, or enter a control operator ID for this diskette.
- 5 = prompt mode for optional modules. The controller needs specific information to handle various terminals or components. Some of the information is required and some is optional. This prompt mode allows you to provide the optional information.
- 6 X = change the control operator display to the 3604 model number specified by X. For example, 6 4 specifies the display unit being used as a 3604-4.
- 7 XX= load link module ID XX.  
XX is 01 for the SDLC link module or 02 for the high performance SDLC link module.
- 8 = cold start with no communication with the host site (no start link command given).
- 9 = warm start with no communication with the host site (no start link command given).

**Notes:**

1. *Use the universal translation table keyboard locations when entering response. See universal translation table under "System Operating Procedures."*
2. *During startup, if all 3604s defined in the configuration process are not available, then the startup message described above is not displayed and an automatic startup is done. In this event, the last 3604 defined is set as the "control operator 3604."*

If you enter 0 XX, system actions are determined by the particular utility loaded. Once the utility has been loaded, the system must be reloaded to return to normal operation.

If you enter 1, 2, 8, or 9, the display will go blank to indicate when the startup is complete, unless an error occurs. If an error does occur, the first line plus an error message will remain on display. Using an operating diskette, the application programs are given control at their startup entry points if specified. The system is ready for use, and you can log on. Using the starter diskette, the 92222 message appears, which indicates that startup is complete and the system monitor is logged on and ready for use.

If you enter 3, a diagnostic test loop is entered. The diagnostic tests are repeated until you press the controller RESET switch. The controller will then reload the data from the diskette, perform the diagnostic tests, and continue with the startup procedure.

If you enter 4, the "control operator 3604" displays a sequence of 5-digit prompt messages (00002, 00003, and 00004 and possibly 00006). After each message is displayed, enter a response as listed in the table below before the next message appears. After you respond to message 00004, the 00001 message is again displayed; key and enter the correct digit or digits in response to the 00001 message.

If you enter 5, the "control operator 3604" displays prompt message 00005. Enter your responses to this message as listed in the table below. After your responses have been completed, the 00001 message is again displayed; key and enter the correct digit in response to the 00001 message. After entering the 00001 message response, a 92076 error message may be displayed. This message indicates that the module IDs displayed are invalid, were entered more than once, or are not available on the loaded diskette. Press the EM (enter) key to continue the startup sequence if these modules are not required or insert the correct diskette and press the controller RESET key.

If you enter 6 X, the model number of the 3604 display is changed to the model number specified by X. This is especially useful when using the starter diskette because only 240-character displays (such as the 3604-2) are defined on the diskette. This change remains in effect until a 3604 display command changes it or until the next startup sequence.

If you enter 7 XX, the module ID you entered is saved and then the 00001 message is displayed again.

**Note:** *On the starter diskette, no optional modules are loaded unless you use the prompt mode for optional modules (enter 5 in response to the 00001 message). When the 00005 message appears, enter the module IDs of only those optional modules that will be needed. (When creating a diskette, no optional modules are needed.) An 82070 error message will appear if you try to load more optional modules than there is space for them in controller storage (especially if the base expansion feature is not installed).*

Startup Prompt Mode Messages

| Displayed Message | Responses*   |
|-------------------|--|
| 00002             | Enter a one- or two-character control unit address (CUA) in hexadecimal. This CUA replaces the CUA on the diskette.  |
| 00003             | <p>Enter a 1 to request dump option; 0 to request no dump option.</p> <p><b>Note:</b> <i>The dump (a copy of information in storage) is used only when there has been a system failure. See messages 82060 and 82066 in "Messages." If the dump option is in effect, operator intervention is required before the system can be loaded again. If unattended operation is planned, the 0, no dump option, should be specified.</i></p>  |
| 00004             | <p>Enter a 1- to 16-character control operator identification code. Valid characters are: 0–9, A–F, X, and blank. After the new control operator identification code is entered, the 90000 message will be displayed. Enter the present control operator identification code. If the correct present code is not entered, the new code will not take effect; the 00004 message will be displayed again and the sequence must be repeated.</p>  |
| 00005             | <p>Individually key and enter up to 16 module identification (ID) codes; codes not entered are not loaded, even if they are available on the diskette. (Each ID code is one or two hexadecimal characters.) The display will show all of the module IDs entered, with the 00005 message. After the last module ID is entered, press the enter (EM) key again to complete the sequence. If 00 is entered, no optional modules will be loaded. If FF is entered, all optional modules requested during the configuration process will be loaded. The optional module IDs are as follows:</p> <ul style="list-style-type: none"> <li>20 = change priority instruction</li> <li>21 = translate instruction</li> <li>56 = original 3614 data encryption technique</li> <li>57 = 3614 DES data encryption technique</li> <li>58 = disk file**</li> <li>5C = data sequencing instructions**</li> <li>5E = SETDSKT instruction</li> <li>68 = enhanced instruction set</li> <li>6A = host link wrap tests (starter diskette only)</li> <li>6D = optional instructions locator</li> </ul> <p><i>(cont. on next page)</i></p> |

\*Press the RE (reset) key twice to leave prompt mode and to return to the 00001 message. Press the EM (enter) key if there is no entry for the item requested, or if all module IDs have been entered on the 00005 message.

\*\*These optional modules are not available on the starter diskette.



Startup Prompt Mode Messages (cont.)

| Displayed Message | Responses   |
|-------------------|---|
| 00005<br>(cont.)  | 83 = 3610, 3611, or 3612 printer<br>85 = 3618 printer<br>86 = 3604 magnetic strip encoder<br>87 = 3614 terminal<br>88† = 3606 or 3608 keyboard, display, and magnetic stripe reader<br>89† = 3608 printer   |
| 00006             | Enter a 5-character transmission XID (in hexadecimal) or press the EM (enter) key only to accept the presently assigned XID. This XID replaces the XID on the diskette. This message appears only if specified by the system programmer and 4 was entered in response to the 00001 message. |

†When entering module IDs 88 and/or 89, a 0A module ID must also be entered during this same sequence.

**STARTUP ERRORS**

If the startup diagnostic tests detect an error, the startup is terminated and one of the following diagnostic test messages is displayed on the 3604 at address 1 on loop 1:

- |         |         |
|---------|---------|
| IDL     | HSH     |
| HSH     | LEC     |
| LDI     | MV2 0   |
| IRT     | MV3 0   |
| HSH     | MV1 XXX |
| LDC     | MV2 XXX |
| INS     | MV3 XXX |
| MVO XXX | ESA     |
| ROS     | INV     |
| PCK     | DTC     |
| LSW     |         |

**Note:** *MV2 and MV3 appear with extended memory feature only and HSH appears only if a diskette read error occurs.*

If the controller detects an error after the startup diagnostic tests have ended, 82XXX error messages are displayed on the 3604 at address 1 on loop 1. Refer to "Messages" for explanations of the error messages. If, after trying again, the error still occurs, notify the service representative.

## LOGON AND LOGOFF

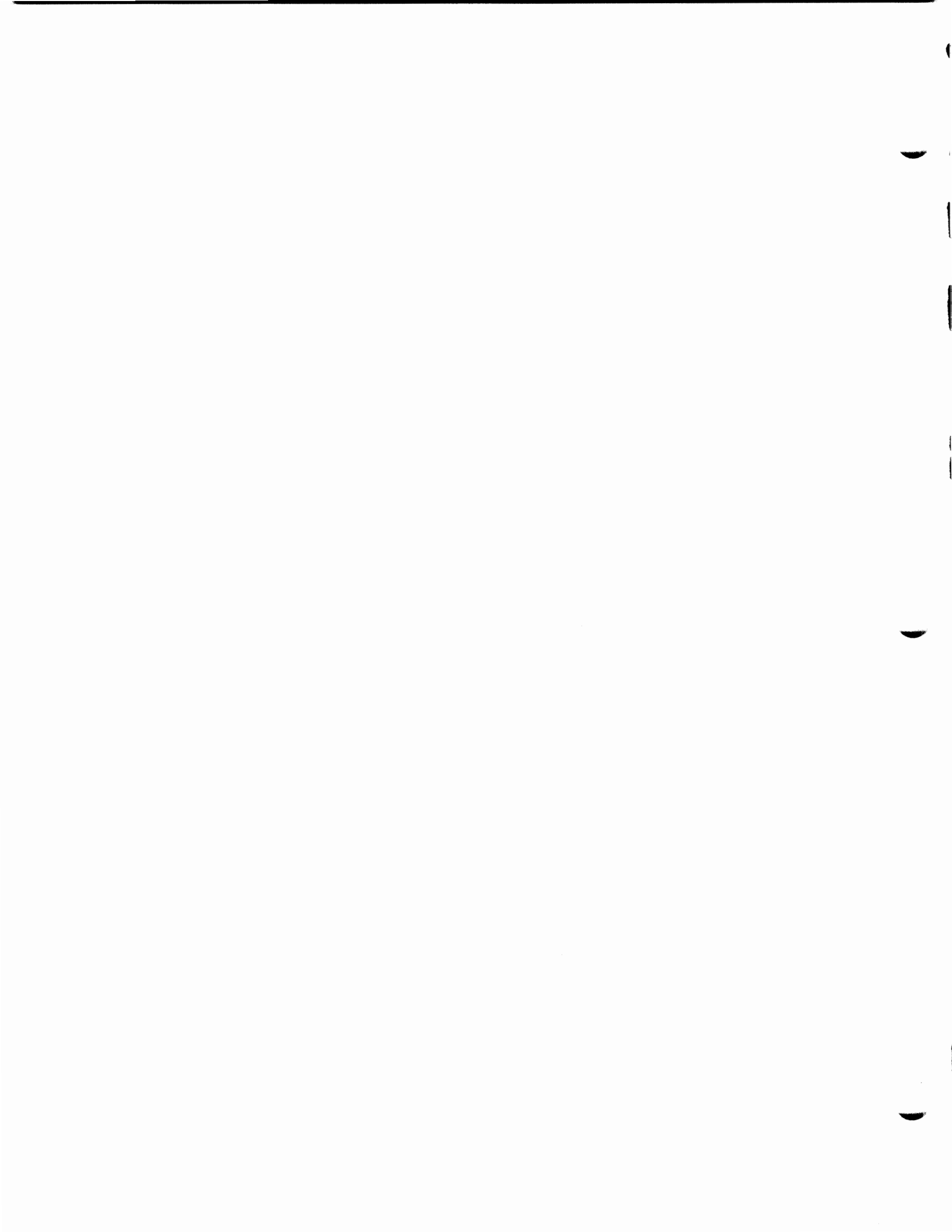
When startup is complete with the starter diskette, message 92222 is displayed to indicate that you are automatically logged on and that you may perform system monitor functions. (See "Startup of the 3600 System.") To log on after a successful startup with the operating diskette or at other times, use the following procedure. To log on at an idle 3604:

1. Press the RESET (as defined by your institution's translation table) key three times.
2. Message 90000 should be displayed. When 90000 is displayed, the layout of the 3604 keyboard keys is as assigned by the universal translation table. For the keyboard layout for the different 3604 keyboards, refer to the figure in "Communicating with the Controller" under "System Operating Procedures."

*Note: If 90000 is not displayed and the CHECK light comes on, either you are logged on at another 3604, a work station is logged on in programmable input mode, or an error was detected during the keying operation. Press the RE (reset) key once and try to log on again. If the CHECK light was defined as the Log Message light during the configuration process and if it comes on with a 90000 message and it is not a keying error, there is a message in the controller log that should be displayed. If you cannot log on because a work station is logged on in programmable input mode, you can force that work station to be logged off by pressing the RESET key 15 times within two minutes. Caution should be exercised when doing this because unrecoverable data may be lost. Pressing the RESET key three more times should cause the 90000 message to be displayed.*

3. Enter your control operator ID at the 3604, using the universal translation table keyboard layout. (The control operator ID is not displayed.)
4. Message 91111 is displayed to indicate a successful logon. If 91111 is not displayed, repeat the logon procedure starting with step 1.

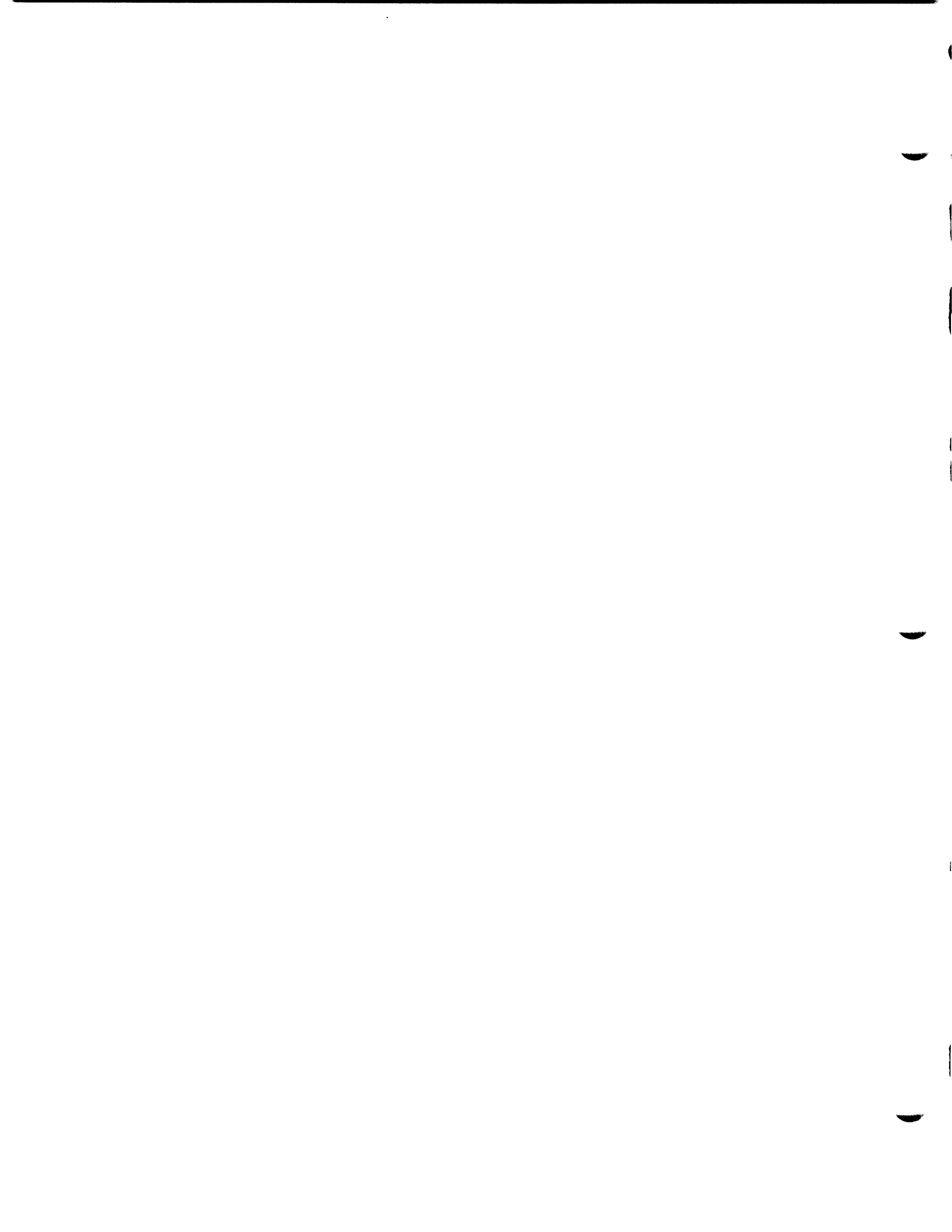
To log off, key in 000 and then press the EM (enter) key. If you cannot enter 000, press the RE (reset) key six times. Three read error messages (90003) will appear, and then logoff will take place. If, during a keyboard entry, three consecutive read errors (90003) occur, you will be automatically logged off.



## Contents – Component Testing

|  |   |
|--|---|
| Assigning the Component to be Tested . . . . .                     | 1 |
| Operating Diskette . . . . .                                       | 1 |
| Starter Diskette . . . . .   | 1 |
| Changing Operating Parameters of Assigned Test Component . . . . . | 3 |
| 3604 Keyboard . . . . .  | 4 |
| 3604 Display . . . . .   | 4 |
| 3608 Printer . . . . .   | 4 |
| 3610 and 3612 Document Printer . . . . .                           | 4 |
| 3611 and 3612 Passbook Printer . . . . .                           | 4 |
| 3618 Printer . . . . .   | 5 |

This page precedes the General Operating Procedures, Component Testing page 1.





## Component Testing

### ASSIGNING THE COMPONENT TO BE TESTED

After logging on, you can test a component by using several control operator commands. But you must first assign the component to be tested by using the 007 command. When using the 007 command, there are different considerations for the operating diskette and the starter diskette, as discussed below.

**Note:** *After any logon, several exception conditions are not displayed when testing a component. These conditions are: intervention required, unit exception, and prior operation. Therefore, if you suspect a problem with the component, use the 062 command to specify the conditions to be displayed or ignored.*

#### Operating Diskette

The terminal component to be tested must have been defined in the configuration process for the operating diskette being used. The 007 command is used to assign the component to be tested. It remains assigned to the control operator until an 007 command is issued for another component or until the control operator logs off.

**Note:** *Caution should be used when assigning a component to be tested because it is removed from the work station that it was originally assigned to by either the configuration process or by an assign request. The work station no longer has the component, and an error will occur if any operations are tried by that work station.*

#### Starter Diskette (prior to EC 745122)

On the starter diskette, the components, their addresses, and the parameters required for the 007 command are as follows:

- Loop 1 – 4800 bps:

| <i>Component</i> | <i>Address</i> | <i>Parameters</i>                              | <i>Required<br/>Optional<br/>Module IDs</i> |
|------------------|----------------|--|---|
| 3604 keyboard    | 1011           | Model 2  | —   |
| 3604 display     | 1012           | Model 2  | —   |
| 3618 printer     | 1024           | 132 print<br>positions,<br>dual forms<br>feed. | 85  |
| 3604 keyboard    | 1031           | Model 2  | —   |
| 3604 display     | 1032           | Model 2  | —   |

| <i>Component</i>               | <i>Address</i> | <i>Parameters</i>  | <i>Required<br/>Optional<br/>Module IDs</i> |
|--------------------------------|----------------|--|---|
| 3604 magnetic stripe encoder   | 1033           | —  | 86  |
| 3610 document printer          | 1044           | Shared, continuous forms with page size and warning line = 0.  | 83  |
| 3612 document printer          | 1054           | Shared, continuous forms with page size and warning line = 0.  | 83  |
| 3611 and 3612 passbook printer | 1055           | Shared, page size of 28 lines, center-fold begins on line 14, center-fold skips 4 lines, and offset steps and lines = 0. | 83  |
| 3614 terminal                  | 1088           |  | 87  |

- Loop 2 – 1200-bps Wrappable Modem

This loop has the same components as loop 1 above plus those listed below. All addresses are the same, except that the first digit is 2.

| <i>Component</i> | <i>Address</i> | <i>Parameters</i>  | <i>Required<br/>Optional<br/>Module IDs</i> |
|------------------|----------------|--|---|
| 3606             | 2076           | Any subaddress is valid  | 88, 0A                                      |
| 3608             | 2077           | Form width = 95 (9.5 inches), initial offset = 6 (0.6 inches), page spacing = 4 (0.4 inches), first line is 10 pitch, any even number subaddress is valid. | 88, 89, 0A                                  |

### Starter Diskette (EC 745122 and later)

On the starter diskette, the test devices are in a free device "pool" and must be activated with the 973 command, with a valid loop and address, before using the 007 command to assign a component for testing.

The test devices can be activated on any of the following valid addresses:

- Loop 1 – address 2 or 3
- Loop 2 – address 2 or 3

**Note:** *With the use of the change loop command (040), loop 2 is the loop to which the change takes place, so addresses 2 and 3 are available for test device activation on all loops.*

A 3604 is available at address 1 on each loop for system monitor control.

Only one of each test device type can be active at any time. Activation of another device on an address that already contains an active device results in the previous device being deactivated and the new device activated on that address.

Activation of a device type that is already active on another address results in the device being deactivated from the previous address and made active on the new address.

Deactivation of all test devices can be accomplished by entering the 973 command with no parameters.

If the attempt is made to either activate an invalid device type or activate on an invalid address, a 90035 message is displayed.

**Note:** *Any components assigned by the 007 command should be de-assigned prior to the activation of any subsequent test device to prevent system monitor conflicts on further 007 commands.*

### Initial CPGEN Configuration

- Loop 1 – 4800 bps:

| Address | Modulus | Device       | Component           | 007 Command Parameters | Device Parameters  | Required<br>Optional<br>Module IDs |
|---------|---------|--------------|---------------------|------------------------|--------------------|------------------------------------|
| 1       | 4       | 3604         | keyboard<br>display | 1011<br>1012           | Model 2<br>Model 2 | —<br>—                             |
| 2       | 4       | test address |                     | 102c                   | —                  | —                                  |
| 3       | 8       | test address |                     | 103c                   | —                  | —                                  |

c = component

- Loop 2 – 1200 bps remote with wrapable modem:

The loop 2 configuration is identical to loop 1 above. All addresses are the same, except that the first digit is 2 in the 007 parameter field.

#### Test Device ID Table

| <i>ID for 973<br/>Command</i> | <i>Device</i>    | <i>Component</i>     | <i>007 Command<br/>Parameter</i> | <i>Device<br/>Parameter</i>   | <i>Required<br/>Optional<br/>Module IDs</i> |
|-------------------------------|------------------|----------------------|----------------------------------|---|---|
| 31                            | 3604             | keyboard             | LSS1                             | Model 2   | —   |
| 31                            | 3604             | display              | LSS2                             | Model 2   | —   |
| 31                            | 3604             | encoder              | LSS3                             | —   | 86  |
| 32                            | 3610 and<br>3612 | document<br>printer  | LSS4                             | Shared, continuous<br>forms page size and<br>warning line = 0.  | 83  |
| 32                            | 3611 and<br>3612 | passbook<br>printer  | LSS5                             | Shared, page size is<br>28 lines, center-<br>fold begins on line 14,<br>centerfold skips 4 lines,<br>and offset steps and<br>lines = 0. | 83  |
| 33                            | 3614             | terminal             | LSS8                             | —   | 87  |
| 34                            | 3618             | printer              | LSS4                             | 132 print positions,<br>dual forms feed.  | 85  |
| 35                            | 3606 and<br>3608 | keyboard/<br>display | LSS6                             | Any even sub-<br>address is valid   | 88,0A                                       |
| 35                            | 3608             | printer              | LSS7                             | Form width = 95<br>initial offset = 6, page<br>spacing = 4, first line is<br>10 pitch, any even number<br>subaddress is valid.          | 89,0A                                       |

If the component to be tested is on loop 1, it is assigned by the 007 command, just as with an operating diskette.

Loop 2 is defined as having a wrappable modem. If loop 2 actually has a wrappable modem, it is only necessary to use the 007 command to assign the component to be tested, just as with an operating diskette. If loop 2 has no modem or has a modem that is not wrappable, the following commands should be given before giving the 007 command:

```
040 0 02 00 02
040 0
```

If the component to be tested is on a loop other than 1 or 2, it is necessary to enter the following commands, before using the 007 command:

```
040 0 0X 00 0Y
040 0
```

X is set to 2 if there is no wrappable modem on the loop (local loop or 600-bps remote loop for countries other than the USA).

X is set to 3 if there is a wrappable modem (1200-bps remote loop).

Y is set to the loop number of the loop to be tested (only 2 to 8 are valid). This same number is also used to specify the loop when using the 007 command to assign the component to be tested.

The first of the above commands stops the loop specified, and makes the changes requested. The 040 0 command then starts the loop.

**Note:** *When changing loop numbers, the 007 command for a component on the loop to be changed must be issued after the 040 commands. If the loop is to be changed again, an 007 command must be issued to reassign the component before issuing the next change-loop sequence.*

## CHANGING OPERATING PARAMETERS OF ASSIGNED TEST COMPONENT

Some operating parameters of components to be tested may be changed by the following keyboard command after the 007 command has been issued:

```
043 FF XX XX XX XX XX
```

where:

FF = one or two hexadecimal characters for the parameter flag byte.

XX = one or two hexadecimal characters of a parameter data byte.  
The number of data bytes to be entered varies from component to component, as described below.

The parameters set up by an 043 command remain in effect until changed by another 043 or an 048 command or until a startup again sets up the original configuration parameters.

The changeable parameter flag byte(s) and data bytes are described in the following paragraphs.



### 3604 Keyboard

Flag byte: The bits of this byte set the end-of-message (EOM) selection mask.  
Data bytes: Not used.

The bits of the flag byte specify which EOM characters defined in the translation table are to be active. If this byte is X'00', the current EOM selection mask is not changed.

### 3604 Display

Flag byte: X'00'  
Data byte 1: 3604 model number, in hexadecimal.

### 3608 Printer

Flag byte: X'00' = no changes.  
X'80' = first line is 10 pitch.  
X'C0' = first line is OCR (7 pitch).  
Data byte 1: Maximum form width (in tenths of an inch).  
Data byte 2: Initial offset (in tenths of an inch).  
Data byte 3: Page spacing (in tenths of an inch).

### 3610 and 3612 Document Printer

Flag byte: X'01' = cut form.  
X'02' = continuous form, no concurrent sharing.  
X'82' = continuous form, concurrent sharing.  
Data byte 1: Page size (number of lines).  
Data byte 2: Warning line (line number).  
Data bytes 3 to 5: Not used.

### 3611 and 3612 Passbook Printer

Flag byte: X'00'  
Data byte 1: \* Page size (number of lines).  
Data byte 2: Center fold begin (line number).  
Data byte 3: \* Center fold skip (number of lines).  
Data byte 4: † Step offset (number of stepper motor steps).  
Data byte 5: \*† Line offset (number of lines).

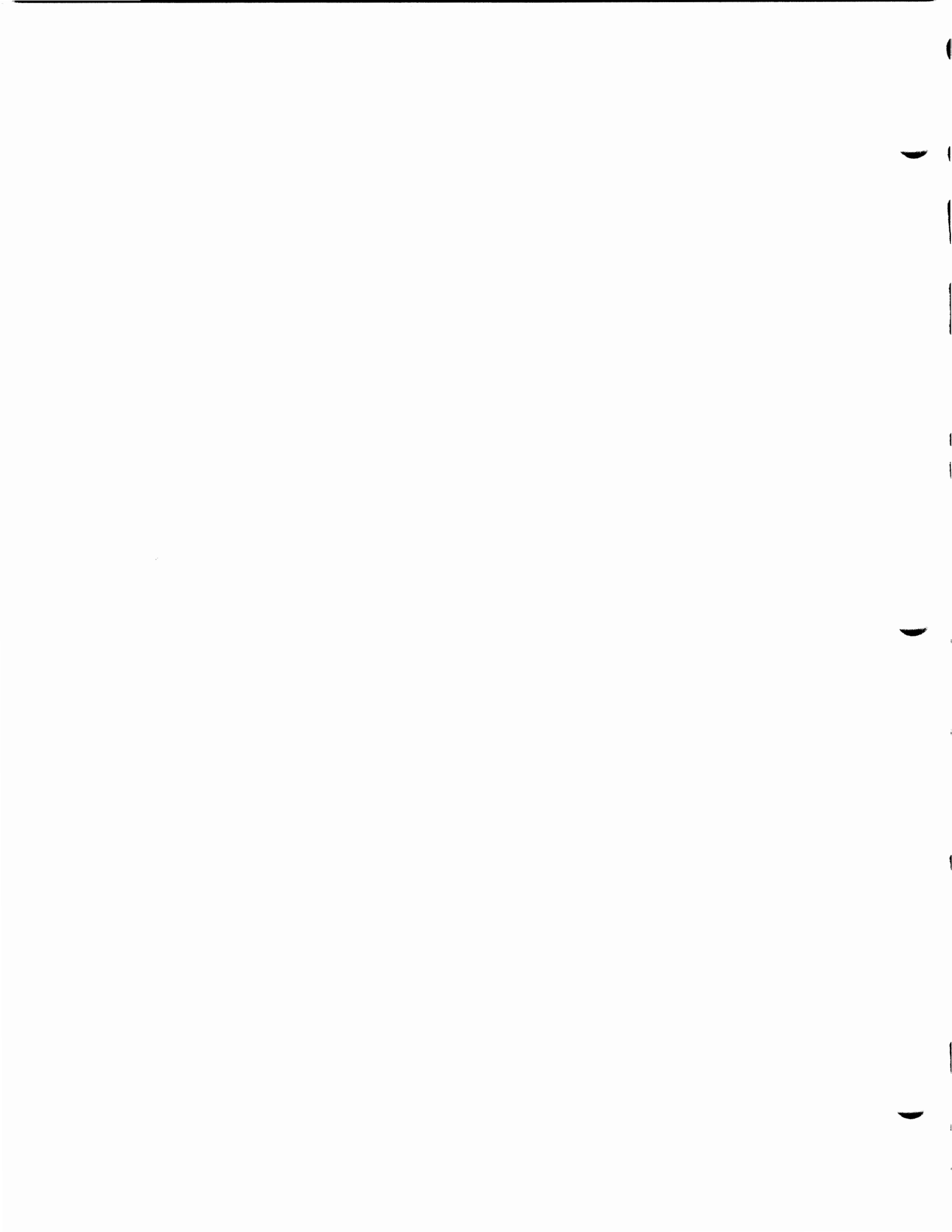
\*Page size plus center fold skip plus line offset cannot exceed 42.

†The number of steps and the number of lines offset are for passbook registration.

### 3618 Printer

There are three possible flag bytes. The data byte meanings depend upon the flag byte:

|                     |   |
|---------------------|---|
| Flag byte:          | X'01' = set parameters of left forms only.            |
| Data byte 1:        | Page size of left feed only (number of lines).        |
| Data byte 2:        | Warning line of left feed.                            |
| Data bytes 3 to 5:  | Not used.   |
| Flag byte:          | X'02' = set parameters of right forms only.           |
| Data byte 1:        | Page size of right feed only (number of lines).       |
| Data byte 2:        | Warning line of right feed.                           |
| Data byte 3:        | Left margin for right feed.                           |
| Data bytes 4 and 5: | Not used.   |
| Flag byte:          | X'03' = set parameters for both left and right forms. |
| Data byte 1:        | Page size of left feed (number of lines).             |
| Data byte 2:        | Warning line of left feed.                            |
| Data byte 3:        | Page size of right feed (number of lines).            |
| Data byte 4:        | Warning line of right feed.                           |
| Data byte 5:        | Left margin of right feed.                            |



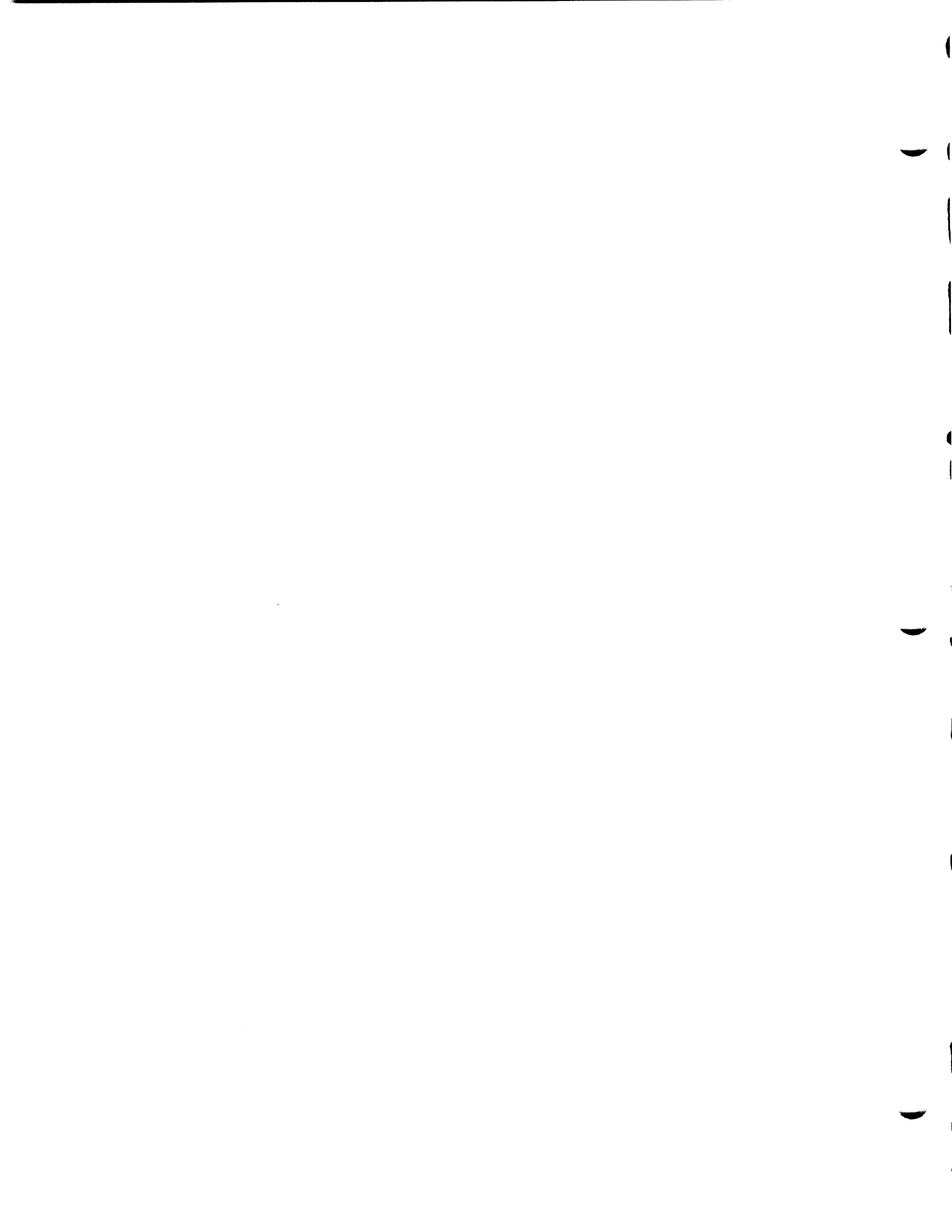
Place all System Operating Procedures pages after this tab.

## **Contents – System Operating Procedures**

- General Information
  - System Monitor
  - Universal Translation Table
  - Communicating with the Controller
- Complete Commands
- Create Diskette
  - General
  - Typical Procedure for Creating a Diskette
- Diskette Formatting
  - General
  - Typical Procedure for Formatting a Diskette
- Transmit Diskette
  - General
  - Identifying the TTRRs
  - Typical Procedure for Transmitting a Diskette
- Display/Print Controller Log
  - General
  - Log Messages
- Display/Print Statistical Counters
  - General
  - Host Communication Link Counters
  - Diskette Counters
  - Disk File Counters
  - Loop Control Counters
  - Terminal Component Counters
- Application Program Modification
- Debug Mode
- Disk File Error Recovery Procedures
  - Moving the System Track
  - Clearing the Initial Tracks
  - Locate Flagged Sector(s) and Assign Alternative Sectors
  - Reformatting Sectors
  - Surface Analysis

This page follows the System Operating Procedures tab.



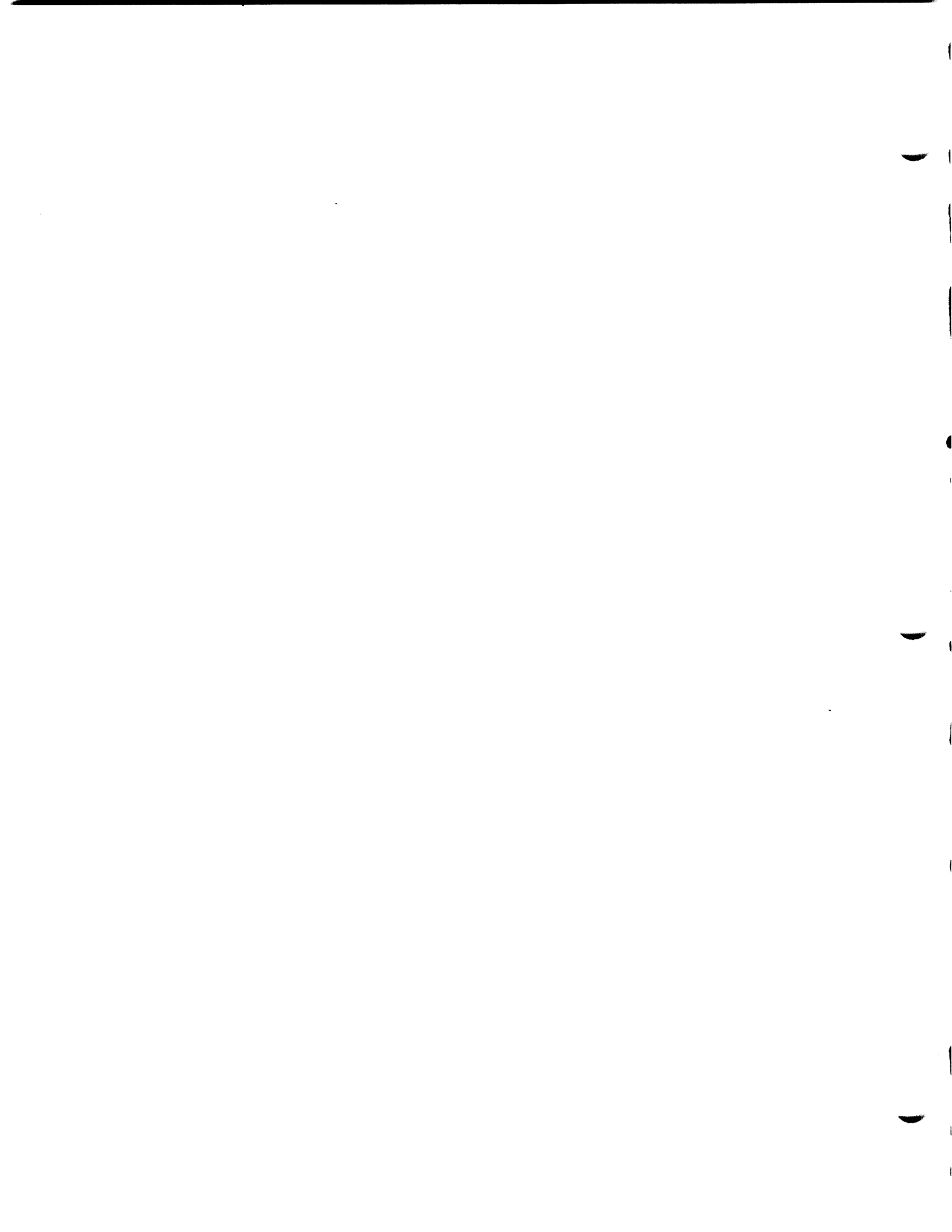


## Contents – General Information

|   |   |
|---|---|
| System Monitor . . . . .                    | 1 |
| Universal Translation Table . . . . .       | 1 |
| Communicating with the Controller . . . . . | 3 |
| Commands and Messages . . . . .             | 3 |
| 3604 Defined . . . . .                      | 3 |

GENERAL INFORMATION

This page precedes the System Operating Procedures, General Information page 1.



## General Information

If you are a control operator, you are the central person for the operation of the 3600 system at your location. Your institution will probably have you coordinate your location operations and, if you are a *local control operator*, coordinate local-remote operations and host site-local operations. This chapter is primarily for you (although required for central site programmers too) and contains the information and procedures you need to carry out these responsibilities.

### SYSTEM MONITOR

You start up and control the operation of the 3600 system by using a facility in the controller called the *system monitor*. The system monitor is also used by application programmers to debug (troubleshoot) their application programs and by service representatives to maintain the system. Some of the things you can do with the system monitor are:

- Start up the 3600 system.
- Create (generate) new operating diskettes.
- Transmit diskettes.
- Print or display the controller log.
- Test the diskette, and read and display any track and record.
- Test components.
- Print or display terminal and component statistical counters.
- Debug application programs.
- Change work station assignments.
- Change terminal parameters.
- Turn on terminal lights.
- Test disk file and move system track.

The system monitor starts up the 3600 system. After startup is complete (using the starter diskette), the system monitor is still in control and you can immediately perform any of the other functions. At any other time, using either the starter or operating diskette, you may use the system monitor from any 3604 Keyboard Display that is not being used by an application program. (When the system monitor is running, other work stations can perform normal operations.) You tell the system monitor what function to perform by entering a numeric code (commands) at the 3604 keyboard.

### UNIVERSAL TRANSLATION TABLE

When ordering 3604 Keyboard Displays, your institution can select one of several keyboards for each 3604 and may then assign any meaning to any key through the application program translation tables. When using the system monitor, however, it is necessary to have a standard keyboard on which each key has only one predefined meaning. This standard keyboard is achieved by using a *universal translation table*. At startup time and after you are logged on (that is, when the system monitor is in control), the 3604 keyboard you use operates with the universal translation table. The keyboard locations and their meanings as defined by the universal translation table are shown in the following figure. Note that keys A through F are included so that hexa-

|    |    |    |
|----|----|----|
| RE | BS | SP |
| 7  | 8  | 9  |
| 4  | 5  | 6  |
| 1  | 2  | 3  |
| 0  |    |    |

|   |    |    |
|---|----|----|
| A | B  | X  |
| C | D  | FR |
| E | F  | AV |
|   |    |    |
|   | 00 | EM |

Legend:

- BS = backspace
- RE = reset
- EM = enter
- NK = return to normal keyboard = 045
- SP = space
- AV = advance key/clear key\*
- FR = free key\*

A. 30-Key Keyboard

|    |    |    |
|----|----|----|
| RE | BS | SP |
| 7  | 8  | 9  |
| 4  | 5  | 6  |
| 1  | 2  | 3  |
| 0  |    |    |

|   |    |    |
|---|----|----|
| A | B  | X  |
| C | D  | FR |
| E | F  | AV |
|   |    |    |
|   | 00 | EM |

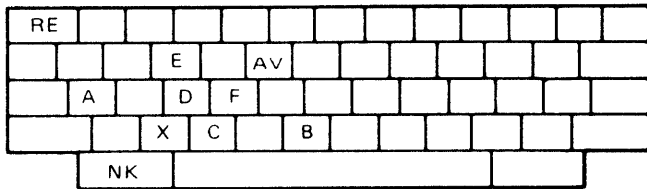
|  |    |    |
|--|----|----|
|  |    |    |
|  |    |    |
|  | NK |    |
|  |    |    |
|  |    | EM |

\*available only with disk file facilities diskette.



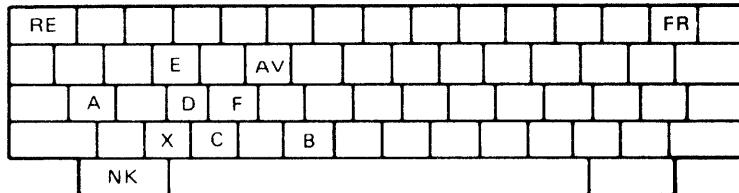
= motor bar available

B. 45-Key Keyboard



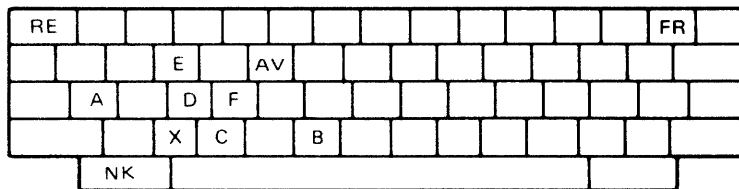
|    |    |    |
|----|----|----|
| FR | BS | SP |
| 7  | 8  | 9  |
| 4  | 5  | 6  |
| 1  | 2  | 3  |
| 0  | 00 | EM |
|    |    | EM |

C. 74-Key Keyboard



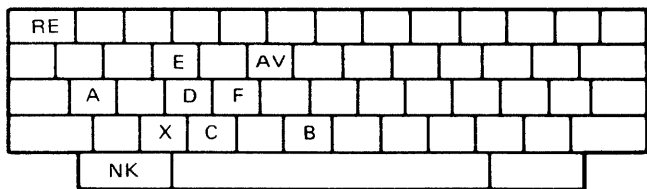
|   |    |    |
|---|----|----|
|   | BS | SP |
| 7 | 8  | 9  |
| 4 | 5  | 6  |
| 1 | 2  | 3  |
| 0 | 00 | EM |

D. 77-Key Keyboard



|   |    |    |
|---|----|----|
|   | BS | SP |
| 7 | 8  | 9  |
| 4 | 5  | 6  |
| 1 | 2  | 3  |
| 0 | 00 | EM |
|   |    | EM |

E. 92-Key Keyboard



|    |    |    |
|----|----|----|
| FR | BS | SP |
| 7  | 8  | 9  |
| 4  | 5  | 6  |
| 1  | 2  | 3  |
| 0  | 00 | EM |

|  |  |  |    |
|--|--|--|----|
|  |  |  |    |
|  |  |  |    |
|  |  |  |    |
|  |  |  |    |
|  |  |  | EM |

F. 94-Key Keyboard



decimal characters may be entered. After being logged on, you can press the NK and EM keys to return the keyboard to the normal application program translation table. However, the normal translation table should not be used unless it provides all the characters and functions available in the universal translation table. If you are using the 30-key keyboard, there is no NK key; in this case, enter 045 and press the EM (enter) key to return to the normal translation table. (See the 045 command in "Complete Commands.")

*Note: After you have keyed in a command or response, you enter this information into the controller by pressing the EM (enter) key. To avoid repetition, this step is usually left out in this and in the following chapters of this guide.*

## COMMUNICATING WITH THE CONTROLLER

### Commands and Messages

You communicate with the controller through a 3604 Keyboard Display. After logging on the system at a 3604, you can use the keyboard at that 3604 to enter numeric commands for the controller. In general, the commands may be divided into eight groups according to their function:

1. Create diskette.
2. Transmit diskette.
3. Display/print controller log.
4. Component testing.
5. Display/print statistical counters.
6. Debug mode.
7. Diskette-related and disk file-related functions.
8. Miscellaneous functions.

For a listing of the commands and their meaning, in numerical order, see "Complete Commands."

The controller communicates with you by displaying 5-digit numeric messages on a 3604 display. Generally, there are three types of messages:

1. Error messages that indicate the controller operation has terminated (82XXX messages).
2. Informational messages (900XX messages, 91111, and 92222).
3. Messages that require responses (000XX messages and 90000).

For a listing of the messages with their meaning and any action required, see "Messages" under "General Operating Procedures."

### 3604 Defined

Three 3604s are defined for communicating with the controller, depending upon when used: (1) the 3604 at address 1 on loop 1, (2) the "control operator 3604," and (3) the 3604 at which you are logged on. (These three 3604s may be physically one, two, or three 3604s.) The following paragraphs discuss these 3604s.

1. The 3604 at address 1 on loop 1:

This is the 3604 on loop 1, whose address switches are set to 1. When using the starter diskette, no terminal on loop 1 that uses addresses 9 and 11 should be turned on.

During system startup using either the starter or operating diskette, three-letter startup diagnostic messages flash on this 3604's display. If a normal startup does not take place, you must check this 3604 for a displayed message. All 82XXX messages appear only on this 3604.

During system startup using a starter diskette, you are automatically logged on at this 3604, if available.

2. The "control operator 3604":

This is the first 3604 in a table that is set up by your institution during the 3600 configuration process. If this 3604 is not working when the controller tries to communicate with it, the controller searches the table, from top to bottom, until it finds a 3604 that is operating. The controller designates the first operating 3604 that it finds as the "control operator 3604" and communicates with it. If all 3604s defined in the configuration process are not available, an automatic startup is done. In this event, the last 3604 defined is set as the "control operator 3604."

The "control operator 3604" may be any 3604 on any loop, local or remote. During system startup, after the three-letter startup diagnostic messages have all flashed on the display at address 1 on loop 1, you use this "control operator 3604" to enter the keyboard responses that complete the startup.

**Note:** *The first 3604 defined and the 3604 at address 1 on loop 1 may or may not be the same physical 3604. This depends upon your institution's choice of a system configuration.*

With a starter diskette, the 3604 at address 1 on loop 1 is the first 3604 defined in the configuration process and, therefore, it becomes the "control operator 3604." Three additional 3604s are defined on the starter diskette. If the 3604 at address 1 on loop 1 is not working at startup, any one of these three additional 3604s could be used as the "control operator 3604," if present. The three additional 3604s are defined in the following order:

- Loop 1, address 3.
- Loop 2, address 1.
- Loop 2, address 3.

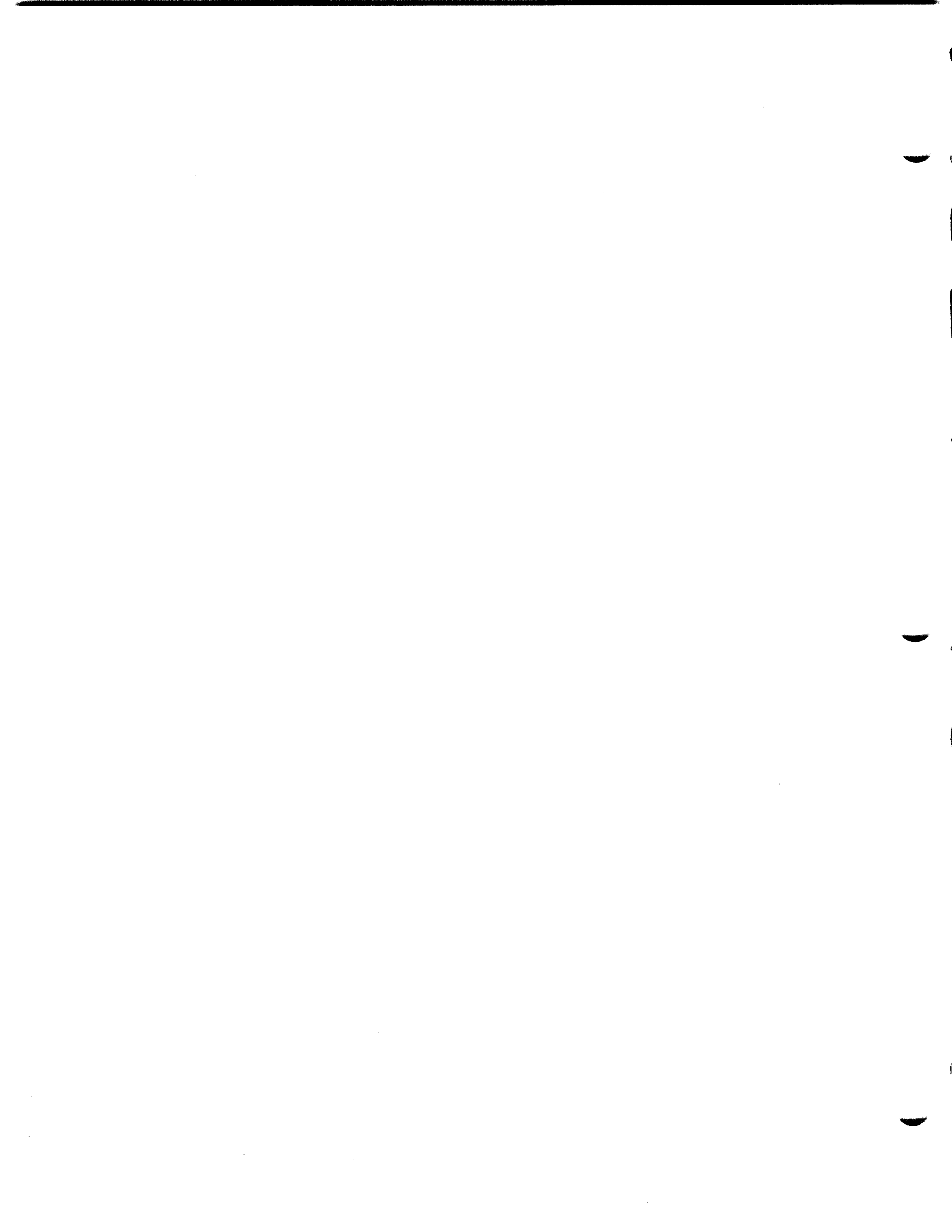
(Loop 2 is a 1200-bps remote loop with a modem that can be wrap tested.)

At least one of these four 3604s must be present and available to use the starter diskette.

3. The 3604 at which you are logged on:

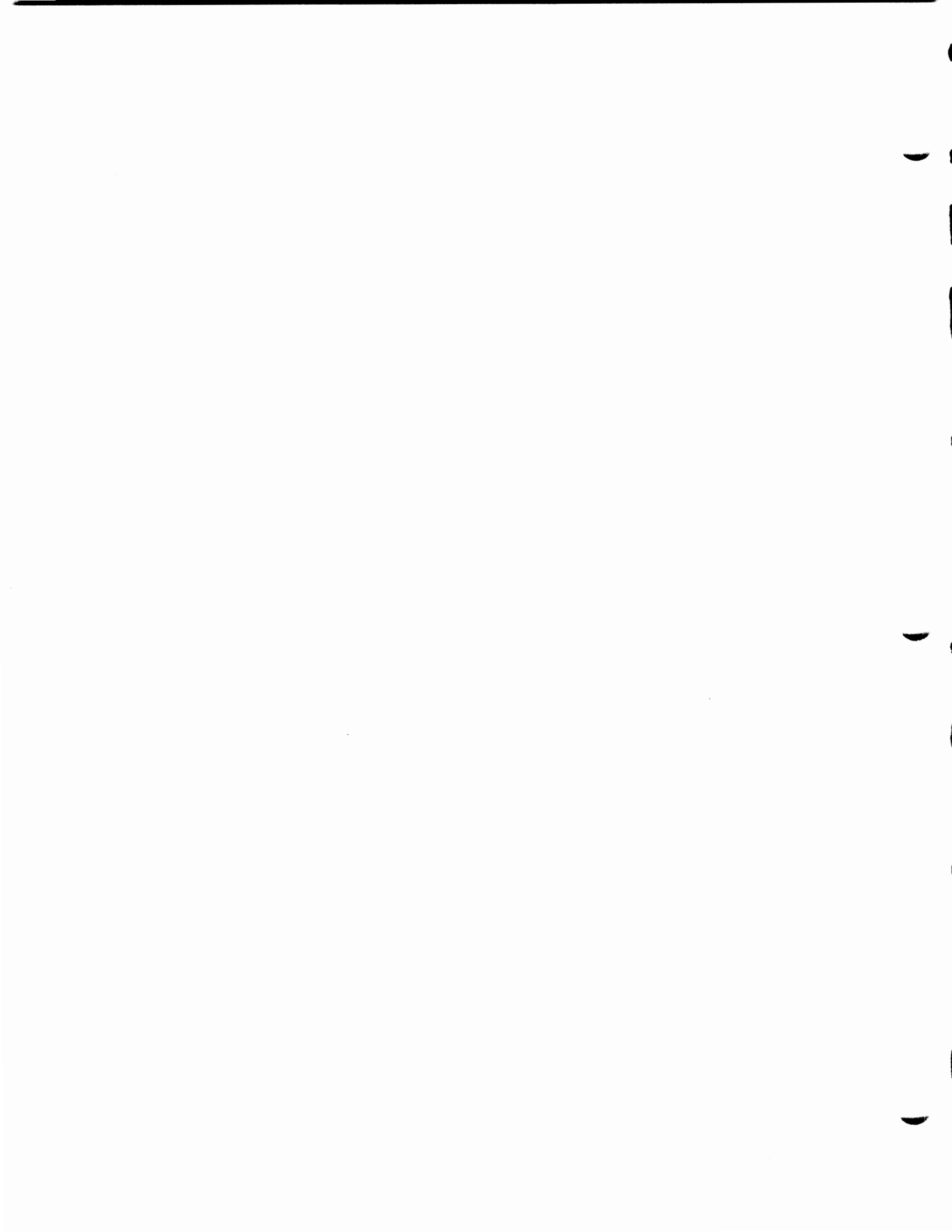
During startup, you are automatically logged on the "control operator. 3604" so that you can enter the keyboard responses that complete the startup. After startup is complete, you may manually log on any 3604 that is idle provided you are not already logged on another 3604.

With a starter diskette, you are not logged off after startup is complete. Instead, message 92222 is displayed, which indicates startup is complete and the system monitor is ready. If desired, you may manually log off this 3604 and log on another 3604.



This page precedes the System Operating Procedures, Complete Commands page 1.





## Complete Commands

After logging on the system at a 3604, you can use the keyboard at that 3604 to enter commands for the controller. The commands, which are listed in numerical order in the table below, may be divided into seven groups according to their function (not all commands are available with all versions of the system monitor):

| <i>Function</i>                       | <i>Commands Used</i>  |
|---------------------------------------|---|
| Component Testing                     | 007, 009, 020, 021, 023–025, 028, 040, 043, 044, 048, 051–053, 055, 060, 062, 066, 069. |
| Debug                                 | 123 (See also debug commands 00–15 in "Debug Mode.")                                    |
| Diskette-Related                      | 030–035, 038, 042, 063, 936   |
| Display/Print<br>Statistical Counters | 010, 012  |
| Display/Print<br>Controller Log       | 001, 002, 046   |
| Disk File                             | 090–095*  |
| Logon/Logoff                          | 000   |
| Miscellaneous                         | 005, 006, 008, 041, 045, 047, 049, 061, 070, 071, 929, 973, 999                         |

When using the commands, keep in mind the following points:

1. As soon as you press the 3604 RESET (as defined by your institution's translation table) key three times, the universal translation table is in effect. While logged on, you can use the NK (return to normal keyboard) key or command 045 to return to your normal application program translation table.

*Note: When the universal translation table is in effect, some of the other keys may still be active.*

2. Most of the 3-digit command codes are followed by groups of letters that represent information you must specify to perform the function. For example:

```
021 ZZZ AAA BBB
046 XXXX YYYY
069 XY
```

---

\*These commands are not available on the starter diskette. Optional module ID 58 must be loaded for these commands to work. Also, they run with scheduling inhibited; see description of 090 command.

The numerical command code and the groups of letters that follow are called *fields*. In this guide the fields are separated by a space, and you *must enter a space between fields*. Leading zeros (zeros entered at the start of a field to give the proper number of characters) are not required in any field except for the command codes and the SS part of the LSSDD field in commands 005, 006, 007, 008, and 010.

3. Enter the fields of a command in decimal unless the field is preceded by (X). In that case, you may enter the field in decimal or hexadecimal. If you enter the field in hexadecimal, the first character of the field should be immediately preceded by X. For example, let's look at command 031:

031 (X)TTRR

where TT = track number  
RR = record number

Thus, to specify track 15 and record 01:

for decimal, enter 031 1501.  
for hexadecimal, enter 031 X0F01 or XF01.

4. You have the option of assigning a component as an output printer (see the 005 and 006 commands). You may use the output printer to get a printed copy of controller log messages (046 command) and statistical counters (012 command). Also, you may use the output printer for a printed record of all keyboard commands and display messages (061 command).
5. When you are logged on using the operating diskette, all output is translated using your institution-generated output translation tables. The output translation table must include all of the universal translation table characters plus \*, —, and T. If all of these characters are not available, translate checks may occur when messages containing these characters are displayed or printed. On the starter diskette, only one output translation table is used. That translation table does not translate correctly when using a 3610 or 3612 printer that has a 128-character print wheel (available in Japan only); therefore these printers should not be used as the output printer.
6. If the controller detects an error while you are logged on, it displays a five-digit error message that begins with a 9. These five digits are followed by four hexadecimal characters that are the two status bytes of the component associated with the error. If 0000 status is displayed, no status has been reported or none is associated with the error. Refer to "Messages" for an explanation of the error messages and the status bytes.

Complete Commands

| Command  | Meaning   |
|--|---|
| <p>000</p>   | <p>Log off. All special conditions, except those set by the 005, 043, 048, 049, 070, 071, 090 commands, are reset. The "control operator 3604," output printer, and test component (if assigned) are returned to the work station they were removed from (unless the 005 command was used).</p>   |
| <p>001 XXXX</p> <p>XXXX = the log message number to begin with. If not entered, the last message is the beginning point.</p> | <p>Display the four-digit message number, a space, and the first 35 characters of message XXXX and the four preceding messages. (The number of messages displayed may have been modified by the 049 command.) Each time the EM (enter) key is pressed, the next most-recent message group is displayed; that is, the log is paged backward.</p> |
| <p>002 XXXX</p> <p>XXXX = log message number.</p>  | <p>Display the four-digit message number, a space, and the full text of log message XXXX (a maximum of 240 characters are displayed). If the <i>message</i> is greater than 235 characters, the message number and the beginning of the message are overlaid by up to 17 characters from the end of the message.</p>                            |
| <p>002 0000 (002 0)</p>  | <p>Display the current diskette status. Two status bytes, XXXX, appear on the next line.</p>  |
| <p>002 9999</p>  | <p>Display the last X1 XXX type of message in the controller log. (Display the full text of the message; a maximum of 240 characters.) This command can be used to display the last log message written that turned on the Log Message light. See "Display/Print Controller Log" for system messages that turn on the light.</p>                |

Complete Commands (cont.)

| Command   | Meaning   |
|---|---|
| <p><b>005 LSSDD X and 006 LSSDD X</b></p> <p>L = loop number (1–8)<br/>           SS = terminal address (0–15)<br/>           DD = component address, as follows (leading 0 is not required):</p> <ul style="list-style-type: none"> <li>1 = 3604 keyboard</li> <li>2* = 3604 display</li> <li>3 = magnetic stripe encoder</li> <li>4* = 3610 or 3612 document printer or 3618 printer</li> <li>5 = 3611 or 3612 passbook printer</li> <li>6 = 3606 or 3608 keyboard, display, and magnetic stripe reader</li> <li>7 = 3608 printer</li> <li>8 = 3614 terminal</li> </ul> <p>X = 0 for A-side or 1 for B-side.<br/>           If X is not entered, or does not equal 1, the A side is used.</p> <p>If the assignment is successful, the assign parameter list is displayed in hexadecimal on the next line as follows:</p> <p>LSD0 XX YY ZZ</p> <p>L = loop number (1–8)<br/>           S = terminal address (0–F)<br/>           D = component address (0–F)<br/>           XX = C1 for A-side; C2 for B-side<br/>           YY = work station ID of previous owner<br/>           ZZ = logical device address (LDA) of previous owner</p> | <p>Assign the specified component as the output printer. These commands are used in conjunction with commands 012, 033, 046, 061, and debug command 13 X (hard-copy trace). The component is removed from the work station it was assigned to and is reassigned when another 005 or 006 command for another component is issued. It is also reassigned when the control operator logs off if the 006 (but not the 005) command was used. The 005 command also starts the hard-copy function; see the 061 command.</p> <p>When a 005 or 006 command for another component is issued, the previously assigned output printer is reassigned before the request is validated. Therefore, if the new request has an invalid component, no output printer is assigned.</p> <p>An output printer cannot be assigned as a test component without entering a 005 or 006 command to reassign it before the 007 command is issued.</p> <p>The 3610 or 3612 document printer, or 3618, when assigned as the output printer, must have continuous forms mode set and have paper wide enough for an 80-character print line. If not, errors will occur. Continuous forms mode can be assigned by means of the 043 command as follows. First issue the 007 command, then define the parameters with a 043 command, then give the 007 command again, followed by the 005 or 006 command.</p> <p>If only 005 or 006 is entered, the component is reassigned to its work station; however, the hard-copy function is not stopped.</p> |

\*Only components that should be assigned as an output printer.



Complete Commands (cont.)

| Command   | Meaning   |
|---|---|
| <p><b>007 LSSDD X</b></p> <p>LSSDD X is the same as for the 006 command.</p> <p>See the 006 command for the format of the output if the assignment is successful.</p>   | <p>Assign the component (or a terminal group component, identified by the 009 command) as the test component. The terminal group component subaddress is set to 0.</p> <p>A test component cannot be assigned as an output printer without entering a 007 command to reassign the test component before the 006 command is issued.</p> <p>If only 007 is entered, the component is reassigned to its work station.</p>  |
| <p><b>008 LSSDD X YY Z</b></p> <p>LSSDD X is the same as for the 006 command, except that X must be specified (no default).</p> <p>YY = work station identification (one or two characters); if YY = 0, the component is placed in a free pool (that is, it is not owned by any work station).</p> <p>Z = logical device address (0-7)</p> <p>See the 006 command for the format of the output if the assignment is successful.</p> | <p>This command removes the component from the free pool or the work station it is currently assigned to and assigns it to the work station specified. The assignment remains in effect until another assign request is issued for that component or until the system is loaded again. Care must be taken because removal of the component from its assigned work station may cause errors at that work station.</p> <p>To reassign the component to the original owner, another 008 command must be issued. The original station ID and logical device address (LDA) were indicated in the parameter list that was displayed when the first 008 command was issued.</p> <p>The keyboard, display, output printer, and test component assigned to the control operator cannot be assigned by the 008 command.</p> |
| <p><b>009 XX</b></p> <p>XX = subaddress (0-15)</p> <p>If the entry is accepted, the terminal address (assigned by the 007 command) is displayed in hexadecimal on the next line as follows:</p> <p><i>(continued on next page)</i></p>  | <p>Assigns a subaddress to the test component in the terminal group specified by the 007 command.</p> <p>If 0 is assigned and a read operation is initiated, the first component in the terminal group with a message is read and its subaddress (set in its subaddress switches) replaces the 0. (For write operations, 0 is an invalid address.)</p>  |

Complete Commands (cont.)

| Command  | Meaning   |
|--|---|
| <p><b>009 XX (cont)</b></p> <p>LSD0<br/>           L = loop number (1–8)<br/>           S = terminal address (0–F)<br/>           D = component address (see 006 command)<br/>           If 0000 is displayed, no test component was assigned.</p>   |   |
| <p><b>010 LSSDD</b></p> <p>L = loop number (1–8)<br/>           SS = terminal address (0–15)<br/>           DD = component address, as follows (leading 0 is not required):<br/>               1 = 3604 keyboard<br/>               2 = 3604 display<br/>               3 = magnetic stripe encoder<br/>               4 = 3610 or 3612 document printer or 3618 printer<br/>               5 = 3611 or 3612 passbook printer<br/>               6 = 3603 or 3608 keyboard, display, and magnetic stripe reader.<br/>               7 = 3608 printer<br/>               8 = 3614 terminal</p> <p>LSSDD = 9001 for host link<br/>           LSSDD = 9002 for diskette<br/>           LSSDD = 9010 for disk file<br/>           LSSDD = X000 for loop control, where X is the number of the loop.</p> <p>The output format is:<br/>           LSDM TT SS XXX XXX XXX . . . . .</p> <p>L = loop number (1–8)<br/>           S = terminal address in hexadecimal<br/>           D = component address in hexadecimal<br/>           M = modulus value for a terminal component, or the speed of a loop (see below).<br/>           TT = component type (see below)<br/>           SS = work station identification (not applicable for host link, diskette, or loop control).<br/>           XXX = count in decimal<br/>           LSDM = 9010 for host link<br/>           LSDM = 9020 for diskette<br/>           LSDM = 9100 for disk file<br/>           LSDM = X0YY for loop control, where X is the number of the loop.</p> <p><i>(continued on next page)</i></p> | <p>Display the statistical counters for the specified component.</p> <p>For detailed information on the statistical counters, see "Display/Print Statistical Counters."</p> |

Complete Commands (cont.)

| Command  | Meaning  |
|--|--|
| <p><b>010 LSSD (cont)</b></p> <p>If YY = loop speed, the values are as follows:</p> <ul style="list-style-type: none"> <li>01 = 4800 bps</li> <li>02 = 2400 bps</li> <li>04 = 1200 bps</li> <li>08 = 600 bps</li> <li>8X = this loop is used for clocking</li> </ul> <p>Component types (TT) are as follows:</p> <ul style="list-style-type: none"> <li>01 = host link</li> <li>02 = diskette or disk file</li> <li>80 = loop control</li> <li>81 = 3604 keyboard</li> <li>82 = 3604 display</li> <li>83 = 3610, 3611, or 3612 printer</li> <li>85 = 3618 printer</li> <li>86 = magnetic stripe encoder</li> <li>87 = 3614 terminal</li> <li>88 = 3606 or 3608 keyboard, display, and magnetic stripe reader</li> <li>89 = 3608 printer</li> </ul> |  |
| <p><b>012 X</b></p> <p>X = number of loops attached to the controller.</p> <p>The output format is the same as for the 010 command.</p>  | <p>Print the statistical counters for all components on the assigned output printer (see the 005 and 006 commands).</p>  |
| <p><b>020 ZZZ YYY AAA BBB</b></p> <p>ZZZ = number of times to run the test. If 000(0) is entered, the printing/display is continuous until the RE (reset) key is pressed twice.</p> <p>YYY = length of line to be printed/displayed (255 maximum).</p> <p>AAA = decimal number that gives the physical position on the print wheel or print belt, or the logical position in the display table, of the first character in a group of consecutive characters to be used.</p> <p>BBB = decimal number that similarly identifies the last character in the group to be used.</p> <p><i>(continued on next page)</i></p>   | <p>Do a ripple print or display on the assigned test component. Assume, for example, that AAA = 010, BBB = 019, YYY = 020, and ZZZ = 005. In this case, the specified character group would be printed/displayed twice on each of five lines. The first line would begin with the character from print/display position 010, the second line would begin with the character from print/display position 011, and so on. If the number of characters from AAA to BBB is less than the line length (YYY), the characters are repeated to obtain the length required. If the number of characters is greater than the line length, the line is truncated (cut short).</p> |

Complete Commands (cont.)

| Command   | Meaning   |
|---|---|
| <p><b>020 ZZZ YYY AAA BBB (cont)</b></p> <p>See the OUTRTBL macro description in the <i>IBM 3600 Finance Communication System Instruction and Macro Reference Manual</i>, GC27-0003, for print/display position numbers.</p>  | <p>If the 060 1 command was issued prior to this command, the first two lines of print may be the same.</p>   |
| <p><b>021 ZZZ AAA BBB</b></p> <p>ZZZ = number of times to run the test. If 000 (0) is entered, the printing/display is continuous until the RE (reset) key is pressed twice.</p> <p>AAA = decimal number that gives the physical position on the print wheel or print belt, or the logical position in the display table, of the first character in a group of consecutive characters to be used.</p> <p>BBB = decimal number that similarly identifies the last character in the group to be used.</p> <p>See the OUTRTBL macro description in the <i>IBM 3600 Finance Communication System Instruction and Macro Reference Manual</i>, GC27-0003, for print/display position numbers.</p>   | <p>On the assigned test component, print/display the group of characters identified by AAA and BBB the number of times specified by ZZZ. If the character group cannot be contained on one line, the remainder of the group will be printed/displayed on the next line. This command can be used to print all the printable characters on a printer. For example, enter 021 1 0 127 to print one line of all characters on a 128-position belt on a 3618, after it has been assigned using the 007 command.</p> |
| <p><b>023 ZZZ YYY AAA BBB</b></p> <p>ZZZ = number of times to run the test. If 000 (0) is entered, printing/display is continuous until the RE (reset) key is pressed twice.</p> <p>YYY = length of printed line (a maximum of 255).</p> <p>AAA = decimal number that gives the physical position on the print wheel or print belt, or the logical position in the display table, of the first of the two characters in the test pattern.</p> <p>BBB = decimal number that similarly identifies the second character.</p> <p>168 identifies the null character (no space or character printed) for the 3610, 3611, and 3612. If 168 is keyed for AAA or BBB, then the line length specified (YYY) must be twice the line length required for the desired test pattern. 168 is invalid on the 3618.</p> <p><i>(continued on next page)</i></p> | <p>Print/display a test pattern on the test component. The pattern will be a repetition of the two characters represented by AAA and BBB. AAA and BBB can be the same number.</p>   |

Complete Commands (cont.)

| Command   | Meaning  |
|---|--|
| <p><b>023 ZZZ YYY AAA BBB (cont)</b></p> <p>See the OUTRTBL macro description in the <i>IBM 3600 Finance Communication System Instruction and Macro Reference Manual</i>, GC27-0003, for print/display position numbers.</p>  |  |
| <p><b>024 ZZZ X</b></p> <p>ZZZ = number of times to run the test. If 000 (0) is entered, reading is continuous until the RE (reset) key on the "control operator 3604" is pressed twice and the EM (enter) key on the test component is pressed or the RE (reset) key on the test component is pressed twice.</p> <p>X = 0 for decimal (EBCDIC) display of the input; 1 for hexadecimal display of the input.</p> | <p>Read data (a maximum of 128 characters) from an input test component (3604, 3606, or 3608) and display the data on the "control operator 3604" in hexadecimal or decimal. The data is not displayed until the test component's EM (enter) or SEND key is pressed. This test can be used to read input keyed in from another 3604; however, the data is not displayed on that 3604. The hexadecimal format allows all non-printing characters to be displayed to verify that the correct characters are placed in the input segment. In the decimal format, spaces are inserted for nonprinting characters.</p> <p>Use the 045 command to change the keyboard translation table for the 3604 at which the control operator is operating; use the 062 command to specify the exception conditions to be displayed or ignored.</p> <p><b>Note:</b> For operation with the starter diskette, when the normal translation table has been specified, the table used is one that will display the scan code for each key that is pressed. The only exception is the scan code for the RE (reset) key, 00, which is not displayed; this key is always the upper-leftmost key. The scan code for the EM (enter) key, 01, is displayed; this key is immediately to the right of the RE (reset) key.</p> |
| <p><b>025 ZZZ TEXT</b></p> <p>ZZZ = number of times to run the test. If 000 (0) is entered, the output is continuous until the RE (reset) key is pressed twice.</p> <p style="text-align: center;"><i>(continued on next page)</i></p>  | <p>Print/display TEXT to the test component. The TEXT can be all text, all hexadecimal data, or a combination of both. The data between Xs should be an even number of characters because each two characters are</p>  |



Complete Commands (cont.)

| Command   | Meaning   |               |                      |              |                      |              |                      |              |   |   |                      |              |                      |              |   |
|---|---|---------------|----------------------|--------------|----------------------|--------------|----------------------|--------------|---|---|----------------------|--------------|----------------------|--------------|---|
| <p><b>025 ZZZ TEXT (cont)</b></p> <p>TEXT = any character available in the active keyboard input translation table. The character X is used to indicate that the data following the X and up to the next X or EM (enter) is hexadecimal data. To put an X in the output, enter XX.</p>  | <p>converted to one hexadecimal character. If an odd number of characters is used, the high-order four bits of the first hexadecimal character are set to 0. For example: If the entry is X123X, the converted data is X'0123'.</p> <p>This test can be used to insert terminal control characters in the output data. See "Terminal Control Characters" appendix in the <i>IBM 3600 Finance Communication System Instructions and Macros Reference</i>, GC27-0003, for a description of the control characters and their function by terminal.</p> |               |                      |              |                      |              |                      |              |   |   |                      |              |                      |              |   |
| <p><b>028 TEXT</b></p>  | <p>Track the TEXT message on the display and then discard it. This command can be used when testing the magnetic stripe reader on the "control operator 3604."</p>  |               |                      |              |                      |              |                      |              |   |   |                      |              |                      |              |   |
| <p><b>030 TEXT</b></p>  | <p>Write TEXT to the diskette as a controller log message.</p>  |               |                      |              |                      |              |                      |              |   |   |                      |              |                      |              |   |
| <p><b>031 (X)TTRR S</b></p> <p>TTRR = track and record number in decimal.<br/>           XTTRR = track and record number in hexadecimal.<br/>           S = side of diskette to use, 0 or 1. If the S field is not entered, side 0 is used. If XTTRR (hexadecimal) is entered, the S field is ignored if side 1 is specified by the RR field; see following note.</p> <p><b>Note:</b> <i>If the S field is not used, the record number entered in the RR field determines the diskette side, as well as the record:</i></p> <table style="margin-left: auto; margin-right: auto;"> <tr> <td style="text-align: center; padding-right: 20px;"><i>Side 0</i></td> <td style="text-align: center;"><i>Side 1</i></td> </tr> <tr> <td style="text-align: center;"><i>TT01 or XTT01</i></td> <td style="text-align: center;"><i>XTT81</i></td> </tr> <tr> <td style="text-align: center;"><i>TT02 or XTT02</i></td> <td style="text-align: center;"><i>XTT82</i></td> </tr> <tr> <td style="text-align: center;"><i>TT03 or XTT03</i></td> <td style="text-align: center;"><i>XTT83</i></td> </tr> <tr> <td style="text-align: center;">↓</td> <td style="text-align: center;">↓</td> </tr> <tr> <td style="text-align: center;"><i>TT14 or XTT0E</i></td> <td style="text-align: center;"><i>XTT8E</i></td> </tr> <tr> <td style="text-align: center;"><i>TT15 or XTT0F</i></td> <td style="text-align: center;"><i>XTT8F</i></td> </tr> </table> | <i>Side 0</i>   | <i>Side 1</i> | <i>TT01 or XTT01</i> | <i>XTT81</i> | <i>TT02 or XTT02</i> | <i>XTT82</i> | <i>TT03 or XTT03</i> | <i>XTT83</i> | ↓ | ↓ | <i>TT14 or XTT0E</i> | <i>XTT8E</i> | <i>TT15 or XTT0F</i> | <i>XTT8F</i> | <p>Read a specified record from a specified track on the diskette, and display the first 64 bytes in hexadecimal. Additional bytes and records on that track can be displayed, if desired, by pressing the EM (enter) key.</p> <p>The top line of the display contains the track and record number in hexadecimal and decimal, the side number, and the displacement of the first byte displayed.</p> <p>After the initial 64 bytes are displayed, each time the EM (enter) key is pressed, the next 64 bytes are displayed. To skip the next 1 to 9 records, enter the number 1 to 9, etc.</p> <p>For example: Enter 031 0201 1 to display the first 64 bytes of track 2, record 1 on side 1. If the EM (enter) key is pressed, the next 64 bytes of record 1 are displayed. If 4 is now entered, the first 64 bytes of track 2, record 5 on side 1, are displayed. If 0 is entered, the first 64 bytes of the current record are displayed.</p> |
| <i>Side 0</i>   | <i>Side 1</i>   |               |                      |              |                      |              |                      |              |   |   |                      |              |                      |              |   |
| <i>TT01 or XTT01</i>  | <i>XTT81</i>  |               |                      |              |                      |              |                      |              |   |   |                      |              |                      |              |   |
| <i>TT02 or XTT02</i>  | <i>XTT82</i>  |               |                      |              |                      |              |                      |              |   |   |                      |              |                      |              |   |
| <i>TT03 or XTT03</i>  | <i>XTT83</i>  |               |                      |              |                      |              |                      |              |   |   |                      |              |                      |              |   |
| ↓   | ↓   |               |                      |              |                      |              |                      |              |   |   |                      |              |                      |              |   |
| <i>TT14 or XTT0E</i>  | <i>XTT8E</i>  |               |                      |              |                      |              |                      |              |   |   |                      |              |                      |              |   |
| <i>TT15 or XTT0F</i>  | <i>XTT8F</i>  |               |                      |              |                      |              |                      |              |   |   |                      |              |                      |              |   |

Complete Commands (cont.)

| Command  | Meaning   |
|--|---|
| <p><b>032 (X)TTRR (X)DDD DATA</b></p> <p>TTRR = track and record number in decimal.<br/>           XTTRR = track and record number in hexadecimal.<br/>           There is no S field; see note under 031 to specify diskette side to be used.<br/>           DDD = the displacement into the record to be changed in decimal (255 maximum).<br/>           XDD = the displacement into the record to be changed in hexadecimal (FF maximum).<br/>           DATA = up to eight hexadecimal bytes (16 input characters). If DATA is an odd number of bytes, the leftmost four bits are set to 0. For example: 032 2503 XA0 123 will replace two bytes of data on track 25 record 3 (of the application program), beginning at displacement X'A0' with X'0123'.</p> | <p>Change the diskette record on the track and record specified with up to eight bytes of data beginning at the displacement specified. Only records containing the application programs can be changed. If any other track and record are specified, the command is treated as an invalid command.</p> <p>If the data length exceeds the number of bytes to the end of the record, the data is truncated (cut short).</p> <p>This command is not accepted when using an operational or a non-3600 system diskette; a 90001 error message will be displayed. With nonoperational diskettes, if the change is accepted, the diskette change count is incremented. This count can be displayed using the 047 command.</p> <p>See "Application Program Modification" for information about using this command.</p> |

Complete Commands (cont.)

| Command  | Meaning  |
|--|--|
| <p><b>033 V (X)AAAAA</b><br/> V = 0 for control storage; 1 for user storage.*<br/> AAAAA = print dump beginning at decimal address AAAAA.<br/> XAAAA = print dump beginning at hexadecimal address AAAA.</p> | <p>Print the standalone dump on an assigned output printer. The dump that is printed is one that was taken when the 82060 message appeared as a result of an 82XXX error. The diskette that contains the dump cannot be loaded; therefore, load another operating or starter diskette and assign a printer with the 005 or 006 command. Enter the 033 command; then press the RE (reset) key twice. (A 90002 error message may be displayed; ignore it and continue.) Remove this diskette and replace it with the one that contains the dump; then issue the 033 command again. After the dump is printed, the 035 and 038 commands may be used or replace the diskette with the one previously removed and enter the 042 0 command. Normal operation can now continue.</p> <p>An output printer must be assigned by means of a 005 or 006 command before issuing the 033 command.</p> <p>If only 033 is entered, the full dump will be printed.</p> <p>To stop the dump at any time, press the RE (reset) key twice.</p> |

\*For the extended user storage dump, on the second dump diskette, the data is accessed as if it is in V = 0. (Enter 033 0.)

Complete Commands (cont.)

| Command  | Meaning  |
|--|--|
| <p><b>034 (X)TTRR (X)TTRR S</b><br/>                     TTRR = track and record number in decimal.<br/>                     XTTRR = track and record number in hexadecimal.<br/>                     S = side of diskette to use; see 031 for details.</p>                  | <p>Do a diskette seek test. The first TTRR and then the second TTRR will be alternately read until the RE (reset) key is pressed twice.</p>  |
| <p><b>035 V (X)AAAAA</b><br/>                     V = 0 for control storage; 1 for user storage.*<br/>                     AAAAA = display dump beginning at decimal address AAAAA.<br/>                     XAAAA = display dump beginning at hexadecimal address AAAA.</p> | <p>Display the standalone dump 32 bytes at a time. To display the next 32 bytes, press the EM (enter) key. The data displayed begins on the next lowest 32-byte boundary to the address requested. For example, if the request was 035 0 X1F0, the display would begin with address 01E0.</p> <p>If only 035 is entered, the display begins with the first 32 bytes of control storage.</p> <p>The diskette that contains the dump cannot be loaded; therefore, load another operating or starter diskette and enter the 035 command. Remove this diskette and replace it with the one that contains the dump, then issue the 035 command again. After the dump is displayed, the 033 and 038 commands may be used or replace the diskette with the one previously removed and enter the 042 0 command. Normal operation can now continue.</p> |
| <p><b>038</b></p>  | <p>Print the controller operational information from the dump diskette(s).</p> <p>See the 033 command for procedures. (The 033 and 035 commands may be used before replacing the diskette and entering the 042 0 command.)</p>   |

\*For the extended user storage dump, on the second dump diskette, the data is accessed as if it is in V = 0. (Enter 035 0.)

Complete Commands (cont.)

| Command   | Meaning   |
|---|---|
| <p><b>040 X YY ZZ CC</b></p> <p>X = 0 to start loops; 1 to stop loops only if in error recovery.</p> <p>YY ZZ CC, as a group, are optional.*</p> <p>YY = one or two hexadecimal characters for the first flag byte in the parameter list, as follows:</p> <p>08 = start/stop loop number CC. The stop is in effect only if the loop is in error recovery.</p> <p>02**= loop CC does not have a modem, or it has a nonwrappable modem.</p> <p>03**= loop CC has a wrappable modem.</p> <p>ZZ = 00.</p> <p>CC = number of the loop to be started or tested.</p> | <p>Start loops that are stopped, or stop loops if the loop is in error recovery. If YY ZZ are not entered, all loops that are stopped are started or all loops in error recovery are stopped. By entering YY ZZ CC, an individual loop is assigned for testing. The command that assigns a new test loop will stop the current test loop (a loop other than loop 1). To start the new test loop, 040 0 must then be entered. See "Component Testing."</p> |

\*If these bytes are not entered, the start or stop loop parameters list is set to 0, and the command applies to all loops. If they are entered, the parameter list values so entered remain in effect until changed another 040 command, or until the next load.

\*\*Starter diskette only. These values change the second loop to the type and number specified.



Complete Commands (cont.)

| Command   | Meaning   |
|---|---|
| <p><b>041 X YY ZZ CC XFF AAAAA</b><br/> X = 0 to start link; 1 to stop link.<br/> If CC is specified, YY and ZZ must be entered.</p> <p><i>If CC and/or AAAAA is entered, YY and ZZ must be entered; if AAAAA is entered, XFF is not required.</i></p> <p>YY, ZZ, CC, XFF, and AAAAA are valid only on a start (041 0). If they are entered on a stop (041 1), they are ignored.</p> <p>YY* = one or two hexadecimal characters for the first flag byte in the parameter list, as follows:<br/> 01 = NRZI encoding<br/> 02 = non-NRZI encoding<br/> 04 = nonwrappable modem<br/> 08 = wrappable modem<br/> 10 = high-speed line**<br/> 20 = low-speed line**<br/> 40 = not-select standby<br/> 80 = select standby</p> <p>ZZ* = one or two hexadecimal characters for the second flag byte in the parameter list, as follows:<br/> 01 = control request to send<br/> 02 = permanent request to send<br/> 04 = data set ready<br/> 08 = connect data set to line<br/> 10 = <i>nonswitched line</i><br/> 20 = <i>switched line</i><sup>†</sup><br/> 40 = <i>extended command indicator</i><br/> 80 = <i>an entry for CC follows</i></p> <p>CC = One or two hexadecimal characters for the control unit address (CUA).</p> <p><i>XFF* = one or two hexadecimal characters for the third flag byte in the parameter list. The character X is required and must be entered if FF is entered. The FF hexadecimal characters have the following meaning:</i><br/> 80 = <i>XID follows</i><br/> 01 to 40 = <i>reserved</i></p> <p><i>AAAAA = the five hexadecimal character identification assigned to the particular controller.</i></p> | <p>Start the host communication link if it is stopped, or stop the link if the link is in error recovery.</p> <p>Specify NRZI encoding except when Western Electric 201B or 201C modems are used on the host communication link.</p> <p>The primary station (IBM 3704/3705) port and the controller(s) connected to that port <i>must</i> be consistent in their specification of NRZI parameter controlling the transmission encoding.</p> <p>If 041 0 is entered while the link is running, the link parameters will not take effect until the link is stopped.</p> |

\*If these bytes are 0 or are not entered, the link parameters remain unchanged. If they are entered, the values so entered remain in effect until changed by another 041 command or until the next load.

\*\*Normally, modems are capable of operating at two speeds. These values identify the speed to be used.

<sup>†</sup>If 20 is entered, 02 is ignored.

**Note:** *The italicized information applies only in a switched link installation; for nonswitched links, ignore the italics.*

Complete Commands (cont.)

| Command   | Meaning  |
|---|--|
| <p><b>042 X</b></p> <p>X = 0 to start the diskette; 1 to stop the diskette.</p>   | <p>Logically start or stop the diskette. The diskette drive is not physically stopped with the stop command. The stop condition also occurs whenever the door to the diskette drive is opened. Once this occurs, the start command must be issued before the diskette can be accessed again. The start command is rejected if another diskette is inserted at any time between startups.</p>   |
| <p><b>043 FF XX XX XX XX XX</b></p> <p>FF = one or two hexadecimal characters for the flag byte in the parameter list.</p> <p>XX = one or two hexadecimal characters of a parameter data byte.</p> <p>The number of parameter data bytes varies from component to component. You must enter all the data bytes for a given component.</p> <p>Refer to "Changing Operating Parameters of Assigned Test Component" under "Component Testing."</p> | <p>Change the operating parameters of the assigned test component. The parameters set up by this command remain in effect until changed by another 043 command or until a load again sets up the original configuration parameters.</p>  |
| <p><b>044 TEXT</b></p> <p>TEXT must be numeric or letters C, D, or E.</p> <p>C = end of inquiry character</p> <p>D = field separator character</p> <p>E = unassigned, available for user</p> <p>The maximum number of characters in TEXT is 36.</p> <p><i>(continued on next page)</i></p>  | <p>Write TEXT on the magnetic stripe encoder. The encoder must be assigned as the test component (007 command), even if it is on the 3604 currently being used as the "control operator 3604."</p> <p>If the input was valid, when the EM (enter) key is pressed, the encoder will be made ready to write and the Encode light, defined during the configuration process, will be turned on. The magnetic stripe can now be passed through the encoder. To read the information on the stripe, pass it through the encoder or reader that is assigned to the "control operator 3604." To remove the encoder ready condition after a 044 command but before encoding takes place, enter 025 1 X0C.</p> <p>Although this test was meant for the encoder, it can be used for any printer or</p> |

Complete Commands (cont.)

| Command  | Meaning   |
|--|---|
| <p><b>044 (cont.)</b></p>  | <p>display assigned by the 007 command. The C, D, and E characters for this test are translated to X'7C', X'7D', and X'7E', respectively. What is actually printed or displayed depends upon your institution-generated translation table for the component. On the starter diskette, the characters displayed are @ ' = respectively.</p>  |
| <p><b>045 X</b></p> <p>X = 0 means assign universal translation table; 1 means assign normal translation table.</p> <p>Default is X = 1.</p> | <p>Change the keyboard translation table for the 3604 at which the control operator is operating.</p> <p>With the starter diskette, when 045 1 is entered, the normal translation table used is one that will display the scan code for each key that is pressed. The only exception is the scan code for the RE (reset) key, 00, which is not displayed; this key is always the upper-leftmost key. The scan code for the EM (enter) key, 01, is displayed; this key is immediately to the right of the RE (reset) key. No commands can be entered when this table is in effect. To leave this mode, press the RE (reset) key twice.</p> |
| <p><b>046 XXXX YYYY</b></p>  | <p>Print controller log messages numbered XXXX through YYYY on the output printer assigned by the 005 or 006 command. If the log message has invalid or unprintable characters, only that part of the message up to the invalid or unprintable character will be printed. Immediately following the last invalid or unprintable character, a 90007 XXXX message will be printed, which indicates a translate check occurred. The rest of the message is not printed.</p>  |
| <p><b>046 0001 9999</b></p>  | <p>Print all controller log messages on the assigned output printer.</p>  |
| <p><b>047</b></p> <p><i>(continued on next page)</i></p>   | <p>Display storage and diskette change counters. These counters are incremented when using nonoperational diskettes; see 02, 10, and 12 debug commands and the 032 command.</p> <p>These counters should be equal to zero when using operational diskettes.</p>   |

Complete Commands (cont.)

| Command  | Meaning   |
|--|---|
| <p><b>047 (cont)</b></p>   | <p>The diskette change counter is never reset; it always shows the number of changes made on the diskette. The storage change counter is reset each time the system is loaded.</p>  |
| <p><b>048 X</b></p> <p>X = 3604 model number</p>   | <p>Change the control operator display to the 3604 model number specified by X.</p> <p>This is especially useful when using the starter diskette because only 240-character displays (for example, a 3604-2) are defined on the diskette. This change remains in effect until a 043 or another 048 command changes it or until the next load.</p>   |
| <p><b>049 XX</b></p> <p>XX = number of lines to be displayed (1-16)</p>  | <p>Change the number of lines displayed to the value specified by XX. (If a value greater than 5 is specified, only the 001 command is affected; all other outputs assume a 240-character display.) The value specified remains in effect until another 049 command is issued or the system is loaded.</p> <p>Display outputs requiring more lines than the value specified will be scrolled. The EM (enter) key must be pressed for the additional lines to be displayed. Pressing the EM (enter) key more times than required to get the full output will cause a 90001 error message to be displayed.</p> <p>To terminate the output before the end, press the RE (reset) key twice.</p> |
| <p><b>051 ZZZ Y</b></p> <p>ZZZ = number of times to run the test. If ZZZ = 000, the test continues until the RE (reset) key is pressed twice.</p> <p>Y = 0 to stop on compare errors; 1 to continue on compare errors.</p> | <p>Wrap-test the 3614 Consumer Transaction Facility using prepared text. To run the test, the 3614 must be in a "closed" state; that is, it will not accept customer input.</p> <p>The prepared text is:<br/>X'FFEEDDCCBBAA99887766554433221100'</p> <p>A count indicating the number of good wrap tests performed will be displayed. If a compare error occurs and a stop on error was requested, the 90022 message is displayed.</p>  |

Complete Commands (cont.)

| Command   | Meaning  |
|---|--|
| <p><b>052 ZZZ Y TEXT</b></p> <p>ZZZ = number of times to run the test. If ZZZ = 0, the test continues until the RE (reset) key is pressed twice.</p> <p>Y = 0 to stop on compare errors; 1 to continue on compare errors.</p> <p>TEXT = up to 50 hexadecimal characters. Two input characters equal one output character. If an odd number of characters are keyed in, the high-order four bits of the output are set to zero. The message must contain an even number of bytes. If not, one byte of X'00' is added to the end of the output.</p> | <p>Wrap-test the 3614 Consumer Transaction Facility using TEXT as the message.</p> <p>A count indicating the number of good wrap tests performed will be displayed. If a compare error occurs and a stop on error was requested, the 90022 message is displayed.</p>   |
| <p><b>053</b></p>   | <p>Display the 3614 error log data. This command causes the eight most recent 3614 error log records to be displayed in hexadecimal.</p> <p>For a description of the 3614 error log messages which pertain to loading, refer to the <i>IBM 3614 Consumer Transaction Facility Programmers Guide</i>, GC27-0010. The balance of the error log messages are for maintenance purposes only.</p> |
| <p><b>055 X</b></p> <p>X = 3604 model number.</p>   | <p>Run the 3604 display test. This test fills the display with check character 1, waits about three seconds, erases the display, then displays check character 2, waits, erases, then repeats with check character 1. Press the RE (reset) key twice to end.</p>   |
| <p><b>060 X</b></p> <p>X = 1 to bypass the check on the write to the test component; 0 to check all writes to the test component.</p>   | <p>Bypass of the check after write operations causes the 3618 to operate faster because of the increased use of the buffers. If the check is bypassed when writing to a 3610, 3611, or 3612, the first line is lost and the second line is printed twice.</p>  |
| <p><b>061 X</b></p> <p>X = 0 for no hard copy; 1 for hard copy.</p> <p style="text-align: center;"><i>(continued on next page)</i></p>  | <p>Provide a hard copy of all keyboard and display messages on the assigned output printer (see the 005 and 006 commands).</p> <p>All hard copy of the input is preceded by **. If only ** is printed, then the EM (enter) key was pressed without any translation input.</p>  |



Complete Commands (cont.)

| Command   | Meaning   |
|---|---|
| <p><b>061 X (cont)</b></p>  | <p>If a printer write error is detected while a hard copy command is in effect, message 90007 is displayed, and, unless the 005 command was used, the hard-copy function stops. To start it again, you must give another hard-copy command (the printer is still assigned).</p>   |
| <p><b>062 X YY</b></p> <p>X = 0 to terminate the test and to display exception status; 1 to try to continue the test ignoring exception status YY.</p> <p>YY specifies errors or exception condition to be ignored:</p> <ul style="list-style-type: none"> <li>80 = intervention required</li> <li>40 = unit exception</li> <li>10 = prior operation</li> <li>02 = unit check</li> <li>FF = all of above</li> </ul> <p>Until any 062 command is issued, intervention required, unit exception, and prior operation are ignored.</p>   | <p>Ignore error conditions specified during read (024 command) or write operations to test components. To obtain status as soon as any error condition(s) or exception condition(s) are detected, key and enter 062 0 and then run the test again.</p> <p>If you want the controller to ignore specific errors or exception conditions during a test, key and enter 062 1 YY and then run the test (where YY is the conditions to ignore).</p> <p>When running a test with Unit Check ignored, there is a possibility that the number of lines printed will not equal the number requested. This depends upon when the Unit Check is encountered.</p> |
| <p><b>063 XX Y</b></p> <p>XX = value in hexadecimal indicating the type of request:</p> <ul style="list-style-type: none"> <li>01 = reset temporary file</li> <li>02 = use Y value on next startup</li> <li>04 = use Y value on all subsequent automatic startups</li> <li>80 = load system immediately; same as pressing controller RESET switch.</li> </ul> <p>Y = startup value. Required only if XX = 02 or 04. See "Startup of the 3600 System" for valid startup values. If Y = 0, the startup value for the request type specified by XX is deleted.</p> <p>Optional module ID 5E is required.</p> | <p>Perform the functions indicated by XX.</p> <p>Care should be exercised when using this instruction; the temporary files (including the system log) will be lost if the reset is requested or an incorrect value is specified for the next or subsequent startups.</p> <p>Multiple requests can be combined with one command by adding the XX code values. For example, 063 83 1 gives the 01, 02, and 80 values. The codes are sequentially processed, in numerical order.</p>   |

Complete Commands (cont.)

| Command   | Meaning   |
|---|---|
| <p><b>066</b></p>   | <p>This command is used when cleaning the print wheels on the 3610, 3611, and 3612 printers. It causes the printer to print 128 characters on each line, in 16 character positions, for 20 lines or until the end of the form or passbook is reached. See "Cleaning the Print Wheel" in the applicable printer operating procedure.</p> |
| <p><b>069 XY</b></p> <p>X = 0 to turn off the lights; 8 to turn on the lights.<br/>           Y = 1, 2, 4, or 8 to identify the light labeled 1, 2, 3, or 4 respectively, or Y = 3, 5, 6, 7, or 9 through F to identify a combination of lights whose individual values add up to Y. For example, 6 would indicate lights 2 and 3.</p> <p>XY = FF to turn on the CHECK light of the 3604 at which the control operator has logged on. To turn off this light, press the RE (reset) key one time.</p>  | <p>Turn on/off the lights on the test component, or turn on the CHECK light of the 3604 at which the control operator has logged on.</p> <p><i>Note: Some 3604s may have an audible alarm associated with one or more of these lights.</i></p>  |
| <p><b>070 X X X X X X X</b></p> <p>Up to seven Xs may be entered. X may be 0–9. Each of these numbers specifies a particular type of event-recording (logging), as follows:</p> <ul style="list-style-type: none"> <li>0 = host link level 1</li> <li>1 = terminal component</li> <li>2 = host link input/output</li> <li>3 = diskette input/output</li> <li>4 = disk file input/output</li> <li>5 = diskette read/write</li> <li>6 = reserved</li> <li>7 = loop control</li> <li>8 = reserved</li> <li>9 = reserved</li> </ul> <p>If no Xs are entered, all events are recorded.</p> | <p>Turn on diagnostic event-recording.</p> <p>This function will be used only under the direction of the 3600 Industry System Support Center. This function is not reset by subsequent loads.</p>   |
| <p><b>071 X X X X X X X</b></p> <p>X = same as in the 070 command. If no Xs are entered, all diagnostic event recording is turned off.</p>  | <p>Turn off diagnostic event-recording, see the 070 command.</p>  |

Complete Commands (cont.)

| Command   | Meaning   |
|---|---|
| <p><b>090 X</b></p> <p>X = 0 to resume scheduling; 1 to inhibit scheduling.</p> <p>Not available on starter diskette; optional module ID 58 is required.</p>  | <p>Inhibit scheduling prevents the scheduling of disk file operations by any work station other than the one issuing the inhibit. This command can reset the inhibit (resume scheduling) regardless of who set the inhibit.</p>   |
| <p><b>091 0 (X)RRR</b></p> <p>RRR = record number in decimal (1–120).<br/>XRR = record number in hexadecimal (1–78).</p> <p>Not available on starter diskette; optional module ID 58 is required.</p>   | <p>Read the specified record from the CE track and display the first 64 bytes. Additional bytes in the record can be displayed, if desired, by pressing the EM (enter) key up to three times.</p>   |
| <p><b>092 0 (X)RRR XX</b></p> <p>RRR = record number in decimal (1–120).<br/>XRR = record number in hexadecimal (1–78).<br/>XX = one or two hexadecimal characters. If no XX is specified, 0's are used.</p> <p>Not available on starter diskette; optional module ID 58 is required.</p>   | <p>Write a 256-byte record to the specified record location on the CE track. The record will be made up of the character specified by X or the character pair specified by XX.</p>  |
| <p><b>093 0 (X)TTT (X)BB (X)TTT</b></p> <p>TTT = track number in decimal (0–999).<br/>XTTT = track number in hexadecimal (0–3E7).<br/>BB = block number in decimal (0–59).<br/>XBB = block number in hexadecimal (0–3B).</p> <p>The maximum valid track number is 337 for the 5 meg disk file and 605 for the 9.3 meg unit.</p> <p>Not available on starter diskette; optional module ID 58 is required.</p>  | <p>Do a disk file seek test. The same block number in the first track and then in the second track will be alternately read until the RE (reset) key is pressed twice or another work station issues an inhibit scheduling. Scheduling is inhibited during each pair of alternate track read operations and is resumed between pairs.</p>   |
| <p><b>094 (X)TTT F</b></p> <p>TTT = track number in decimal (0–999).<br/>XTTT = track number in hexadecimal (0–3E7).</p> <p>F = 0 for moveable head; not 0 for fixed head request.<br/>Default is F = 0.</p> <p>The maximum valid track number is 337 for the 5 meg disk file and 605 for the 9.3 meg unit. However, tracks 334–337 (5 meg) and 602–605 (9.3 meg) are reserved and should not be specified.</p> <p>The valid fixed-head track numbers are 0–7.</p> <p style="text-align: center;"><i>(continued on next page)</i></p> | <p>Move system track to track TTT.</p> <p>There are two possible prompt messages that may result from this command:</p> <p>00040 TTT Y – The requested track is not available. TTT identifies the first available track; Y = 0 indicates moveable head; Y = 1, fixed head. Reply: Enter 0 to use first available track TTT; not 0 to not move system track.</p> <p>00041 TTT – An error was detected while reading a block on the current system track. TTT identifies the DSCB number of the record that is displayed in hexadecimal following the message. Reply: Press EM (enter) key to leave data in block as it is, or enter new data replacing old data (use</p> |

Complete Commands (cont.)

| Command   | Meaning  |
|---|--|
| <p><b>094 (X)TTT F (cont)</b></p> <p>Not available on starter diskette; optional module ID 58 is required.</p>  | <p>advance key to space over old data that is not to be changed); press EM (enter) key after last data byte change.</p> <p><i>Note: The scheduling is inhibited until the system track is moved. If scheduling is inhibited when this command is issued, it waits in a pause loop until scheduling is resumed or the RE (reset) key is pressed twice.</i></p>          |
| <p><b>095 (X)DDD A</b></p> <p>DDD = DSCB number in decimal.<br/>           XDD = DSCB number in hexadecimal.<br/>           A = 0 to display specified DSCB; 1 to display first active DSCB starting with specified DSCB. Press EM (enter) key to display subsequent active DSCBs up to the highest numbered active DSCB.</p> <p>Not available on starter diskette; optional module ID 58 is required.</p>  | <p>Read and display the specified DSCB. The display format consists of two lines: The first line contains the DSCB number in decimal, then eight bytes of the DSCB beginning with the flag byte after the user data (user data is not displayed). The second line contains the last 13 bytes of the DSCB, beginning with the first extent's starting track number.</p> |
| <p><b>123 XX</b></p> <p>XX = work station identification. This can be one or two characters.</p>  | <p>Enter debug mode for work station specified by XX.</p> <p>Once the debug mode is entered, only the two-digit debug commands are valid. To leave the debug mode, enter 00.</p> <p>Refer to "Debug Mode" for information.</p>   |
| <p><b>888</b></p> <p>Available on the starter diskette or with some system monitor versions.</p>  | <p>Enter transmit diskette function. When this function is active, the only keyboard entries allowable are replies that must be made to displayed system messages. See "Transmit Diskette" for prompt messages and information.</p>  |
| <p><b>929 ZZZ C FF AA TT</b></p> <p>ZZZ = number of times to run the test.<br/>           C = 0 to stop on any error; 1 to continue wrap test only if wrap failed (status = 0203).<br/>           FF = 01 to perform adapter wrap test; 02 to perform modem wrap test.<br/>           AA = adapter address (15 or 80 to 83).<br/>           TT = 00 for synchronous adapter; 01 for asynchronous adapter. Default is TT = 00.</p> <p>Available on starter diskette only; optional module ID 6A is required.</p> | <p>Wrap host link adapter.</p>   |

Complete Commands (cont.)

| Command  | Meaning   |
|--|---|
| <p><b>936 (X)TTRR XX S</b></p> <p>TTRR = track and record number in decimal.<br/>           XTTRR = track and record number in hexadecimal.<br/>           XX = one or two hexadecimal characters. If no XX is specified, 0's are used.<br/>           S = side of diskette to use; see 031 for details.<br/>           If S is entered, XX must also be entered.</p> <p>Available on the starter diskette only.</p>   | <p>Write a 256-byte record to the diskette track and record location specified by TTRR. TTRR cannot be lower than 3901 on either side. The record will be made up of the character specified by X or the character pair specified by XX. A good exercise would be to make XX = 5A in one test and A5 in the next.</p> <p>Any diskette, including the starter diskette, that is written on using this command can no longer be loaded; a new diskette must be created on it.</p>   |
| <p><b>973 LSSTT</b></p> <p>L = loop number (1–8).<br/>           SS = modulus indication:<br/>               02 for modulus 4<br/>               03 for modulus 8<br/>           TT = device type<br/>               31 = 3604<br/>               32 = 3610, 3611, 3612<br/>               33 = 3614<br/>               34 = 3618<br/>               35 = 3606, 3608</p> <p>Available on the starter diskette only.</p>  | <p>Activate or deactivate the specified device. A 973 command without LSSTT deactivates all activated devices. The command with LSSTT deactivates the activated device or activates the device if it is not activated.</p>  |
| <p><b>999 H M T VVVVVVCCMM...MMXXXXX</b></p> <p>H = 0 for session initiation by the host; 1 for session initiation by the controller. If 1 is entered, Subsystem Support Services (SSS) must be active in the host.<br/>           M = 0 to use a mounted diskette; 1 to cause a request for another diskette to be mounted. Default is M = 0.<br/>           T = 0 to indicate that a temporary file is not to be overwritten with zeros; 1 to indicate that a temporary file is to be overwritten with zeros. Default is T = 0.<br/>           VVVVVV = VOLID to be written on the diskette. Default is six blanks.<br/>           CC = control unit address (CUA) to be written on the diskette. Default is X'40'.<br/>           MM...MM = control operator ID code to be written on the diskette. The ID consists of from 1 to 16 characters. Valid characters are 0–9, A–F, X, and blank. Default is 16 blanks.<br/>           XXXXX = transmission ID for the switched network. If entered, MM...MM must be 16 characters. Default is X'00000'.</p> | <p>Enter create diskette function. When this function is active, the only keyboard entries allowable are replies that must be made to displayed system messages. See "Create Diskette" for prompt messages and information.</p> <p><i>Note: If any fields are entered with the 999 command, no prompt messages, except possibly 00012 or 00013, will be displayed.</i></p> <p>Once 999 is entered, the system must be reloaded before other functions can be performed at the keyboard. This function is available on the starter diskette or with some system monitor versions.</p> <p><i>Note: If the fields following the H M T fields are not entered, the defaults will be taken unless the host has sent values for these fields.</i></p> |

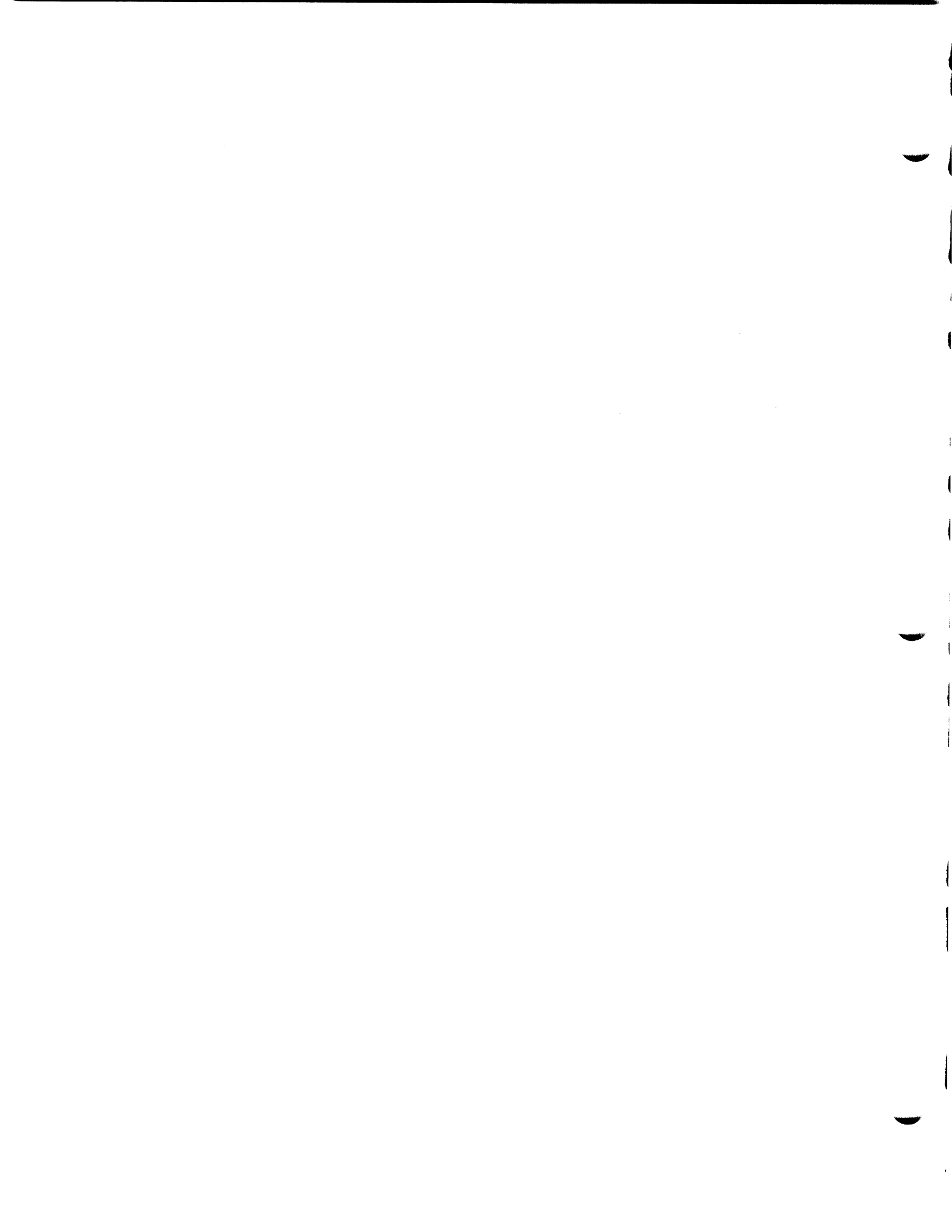


## Contents – Create Diskette

|   |   |
|---|---|
| General . . . . .                                   | 1 |
| Typical Procedure for Creating a Diskette . . . . . | 1 |

CREATE DISKETTE

This page precedes the System Operating Procedures, Create Diskette page 1.



## Create Diskette

### GENERAL

The create diskette function, which is available on the starter diskette and with some versions of the system monitor, has two purposes:

1. To create an operating diskette for a specific controller (from host-transmitted data).
2. To replace the application programs on an existing operating diskette (from host-transmitted data).

Before an operating diskette can be created:

1. The configuration image and the application program(s) for the 3600 system that will use the operating diskette must be prepared by the host.
2. The communication link between the host and the controller that will create the operating diskette must be working.
3. Communication between the controller location and the host must take place to coordinate the create diskette function. (The host must know which 3600 system the operating diskette will be created for and also which controller will perform the create diskette function. The controller location must know when the host is ready and when to activate the create diskette function.) Both locations will follow your institution's procedures for performing this communication and coordination.

At the point in your institution's procedure at which you are instructed to activate the create diskette function, insert the starter diskette and start up the controller. After startup is complete, key and enter 999 at the 3604 at which you are logged on to enter the create diskette function. While the create diskette function is active, no other system monitor functions are allowed. Enter only the responses to the prompting messages that appear on the 3604 display. One of the prompt messages will tell you to remove the starter diskette and to insert a formatted diskette into the controller. The control code, configuration image, and application program(s) are transmitted to the controller and placed on the formatted diskette, thus creating the operating diskette.

**Note:** *If your system has the BSC RPO installed, refer to the IBM 3600 Finance Communication System Custom Feature Description for BSC3 Communication, RPO 8K0598 and 8K0599, GC22-9026, for further information.*

### TYPICAL PROCEDURE FOR CREATING A DISKETTE

Although your institution will prepare its own procedure for creating a diskette, the procedure below is a typical example. The following tables list the create diskette function prompt messages and the actions required on your part and the 9007X error messages that can appear *only* during the create diskette procedure. Other 900XX error messages, however, may appear. For these messages, refer to "Messages" under "General Operating Procedures."

1. Insert the starter diskette and press the RESET switch on the controller.

Follow the rules for using the starter diskette. (See "Startup of the 3600 System.")

**2. Make sure that the startup message has the correct VOLID and CUA.**

The VOLID (volume ID) for the starter diskette is STRDSK.

If the CUA (control unit address) on the diskette is not the correct address for the controller being used, it can be changed in either of two ways:

- a. In response to 00001 of the startup message, key and enter 4 to cause a prompt mode startup. The "Startup Prompt Mode Messages" table shows how a CUA can be written on the diskette in a prompt mode startup. The CUA written on the starter diskette in this way remains across startups. After the prompt mode startup sequence is completed, 00001 is again displayed.
- b. In response to 00001 of the startup message, key and enter 8 to cause a cold start with no start link command issued. When the automatic logon message 92222 appears, start the link and give the correct CUA by keying and entering: 041 0 YY ZZ XX, where XX is the CUA, and YY and ZZ are as specified in "Complete Commands." This CUA remains across logoffs, but not across startups.

Optional modules are not automatically loaded by the starter diskette. If other functions are to be performed before the create diskette function, then the appropriate optional modules should be loaded. See the 00005 message in the "Startup Prompt Mode Messages" table.

**3. Key and enter an 8 to cause a cold start without starting the communication link.**

**4. Wait for the 92222 message.**

When the 92222 message appears, the system is active and ready to accept commands.

**5. When the 92222 message appears, enter the 041 command (start link command) with parameters to match your institution's communication link.**

See the 041 command.

The starter diskette communication link has been defined with all defaults taken. If the definition is not the same as for the controller being used, the 041 command must be issued before entering the create diskette function. The communication link default definitions are as follows:

- a. NRZI encoding
- b. Nonwrappable modem
- c. High-speed line
- d. Nonswitched line
- e. Data terminal ready
- f. Control request to send

**6. Key and enter 999 to activate the create diskette function.**

If no parameters are entered with the 999 command, the prompt messages in the following steps are displayed. If any parameters are entered, no prompt messages will be displayed, unless M = 1 was entered. (M = 1 will cause the 00012 or 00015 message to be displayed.) Note that the parameters are positional, and trailing parameters do not have to be entered if their defaults are acceptable (see the 999 command).

**7. When the 00010 message appears, enter 0.**

0 means the host will initiate the session.

**8. When the 00012 message appears, insert the formatted diskette with the VOLID identified in the 00012 message.**

Between messages 00012 and 00030, the top line of the display will show the Key List Index (0001 to 0005) followed by the track and record number being written on the diskette.

**9. When the 00030 message appears, enter 0, or enter 1, space, and then the VOLID desired.**

0 means use the VOLID given in the 00012 message.

**10. When the 00032 message appears, enter 0, or enter 1, space, and then the CUA desired.**

0 means use the CUA given in the 00032 message.

**11. When the 00034 message appears, enter 0, or enter 1, space, and then the control operator ID code desired.**

0 means use the ID code transmitted from the host. If a new ID code is entered, the 90000 message is displayed. Enter the ID code transmitted from the host; if the wrong code is entered, the new code will not take effect and the 00034 message will be displayed again and the sequence must be repeated. If an ID code was not transmitted from the host, blanks are used, and just pressing EM (enter) is sufficient.

**12. When the 00036 message appears, enter either 0 or 1.**

0 means to not write zeros in the temporary file on the diskette; 1 means to write zeros.

**13. When the 00038 message appears, enter 0, or enter 1, space, and then the XID desired.**

0 means to use the XID given in the 00032 message.

**14. When the 00014 message appears, the create diskette function is finished, and you now have a new operating diskette.**



Create Diskette Prompt Messages

| Message               | Meaning   | Action   |
|-----------------------|---|--|
| 00010                 | <p>This message appears after the 999 command has been entered or if a restart is required. It asks: Who will initiate the session, the host or the controller?</p> <p>If the session is initiated by the controller, only a complete diskette can be created. Application program replacements must be initiated by the host.</p>  | <p>Key and enter 0 or 1.<br/>0 = host will initiate session;<br/>1 = controller will initiate session.</p> <p>If 1 is entered, Subsystem Support Services (SSS) must be active in the host.</p>  |
| 00012<br>XXXXXX*<br>S | <p>This message is a request to remove the starter diskette and insert a diskette in the diskette drive. This message appears when a complete diskette is to be created. The characters XXXXXX may or may not be displayed. If they are displayed, the diskette with VOLID=XXXXXX should be inserted.** If these characters are not displayed, any formatted diskette can be inserted. If the characters are not displayed, XXXXXX = six blanks. When S is displayed, insert a one-sided diskette if it is 1, or a two-sided diskette if it is 2.</p> | <p>Remove the starter diskette and insert the requested diskette in the controller diskette drive. No operator keyboard response is required. About 10 seconds after the diskette has been inserted, the diskette drive should move to track 0 where the VOLID is read. If there is no diskette drive activity after a 15-second period, open and close the diskette drive door.</p>   |
| 00013<br>XXXXXX*      | <p>This message means either:</p> <ol style="list-style-type: none"> <li>1. The diskette inserted in the diskette drive is not in keeping with the request in message 00012.</li> <li>2. The diskette is in keeping with the request to load any formatted diskette. XXXXXX is the VOLID of the inserted diskette.</li> </ol>   | <p>Either of the following:</p> <ul style="list-style-type: none"> <li>● Key and enter 0 to indicate that the create diskette function should continue, regardless of whether the VOLID is in keeping with message 00012.</li> <li>● Key and enter 1 to tell the system to read the diskette VOLID again. Then load a diskette that is in keeping with message 00012 or load any diskette you are willing to use.</li> </ul> |
| 00014                 | <p>The create diskette function, whether creating a complete diskette or replacing the application program(s), has been completed. This message may be followed by message 00010, 00012, 00015, or an error message, depending on the next message received from the host.</p>  | <p>No operator response is required.</p>   |

\* } (See notes at end of table.)  
\*\* }

Create Diskette Prompt Messages (cont.)

| Message          | Meaning  | Action   |
|------------------|--|--|
| 00015            | This message is the same as 00012, except that only the application programs will be replaced. The rest of the diskette will not be changed.   | Remove the starter diskette and insert the requested diskette in the controller diskette drive.<br><br>Because only the application programs are replaced, it is important that the diskette with the VOLID requested be inserted.   |
| 00020            | The control operator has signaled attention by pressing the RE (reset) key twice.  | Either of the following: <ul style="list-style-type: none"> <li>● Key and enter 0 to continue at the point interrupted.</li> <li>● Key and enter 1 to tell the host to terminate the session. When the host has terminated the session, the 00010 message is displayed.</li> </ul>                                       |
| 00030<br>XXXXXX* | This is a request for the control operator to indicate the VOLID that should be written on the diskette just created. If there is no XXXXXX, then the VOLID is blank. This message will not appear if only application programs were replaced.   | Either of the following: <ul style="list-style-type: none"> <li>● Key and enter 0 to indicate that the displayed XXXXXX should be the VOLID written on the diskette.</li> <li>● Key and enter 1 followed by a space and as many as six characters that give the VOLID to be written on the diskette.</li> </ul>          |
| 00032<br>XX*     | This is a request for the control operator to indicate the control unit address (CUA) that should be written on the diskette just created. This message will not appear if only application programs were replaced. If the load request from the host did not contain a CUA, then the CUA used at startup time is substituted and appears in this message. | Either of the following: <ul style="list-style-type: none"> <li>● Key and enter 0 to indicate that the displayed XX should be the CUA written on the diskette.</li> <li>● Key and enter 1 followed by a space, followed by one or two hexadecimal characters that give the CUA to be written on the diskette.</li> </ul> |

\*(See note at end of table.)

Create Diskette Prompt Messages (cont.)

| Message        | Meaning   | Action   |
|----------------|---|--|
| 00034          | This is a request for the control operator to indicate the control operator ID that is to be written on the diskette just created. This message will not appear if only application programs were replaced.   | <p>Either of the following:</p> <ul style="list-style-type: none"> <li>• Key and enter 0 to indicate that the control operator ID code transmitted from the host is the one to be written on the diskette.</li> <li>• Key and enter 1 followed by a space and the control operator ID code to be written on the diskette. The ID consists of 1 to 16 characters. Valid characters are 0–9, A–F, X, and blank. After the new ID code is entered, the 9000 message is displayed. Enter the ID code transmitted from the host. If the wrong code is entered, the new code will not take effect; the 00034 message will be displayed again and the sequence must be repeated.</li> </ul> |
| 00036          | This is a request for the control operator to indicate if the temporary file on the diskette is to be overwritten with zeros.   | <p>Either of the following:</p> <ul style="list-style-type: none"> <li>• Key and enter 0 to indicate that the temporary file on the diskette is not to be overwritten with zeros.</li> <li>• Key and enter 1 to indicate that the temporary file on the diskette is to be overwritten with zeros.</li> </ul>   |
| 00038<br>XXXXX | This is a request for the control operator to verify the XID to be associated with this diskette, where XXXXX is the currently assigned XID. This message appears only if specified by the system programmer. | <p>Either of the following:</p> <ul style="list-style-type: none"> <li>• Key and enter 0 to accept the currently assigned XID.</li> <li>• Key and enter 1 followed by a space and NNNNN to change the XID to NNNNN.</li> </ul>   |

*\*In this table, the XXXXXX characters are shown under the 000NN part of the message. On the display, the XXXXXX characters are on the same line as the 000NN part of the message.*

*\*\*The VOLID of an existing diskette is displayed each time the diskette is loaded. The top line of the startup message contains seven groups of characters. The VOLID is the second group of characters. If unable to load a diskette, the VOLID can be obtained by displaying track 0, record 7, of the diskette in question. To do so, log on as the control operator and issue the 031 command for that track and record (see the 031 command in "Complete Commands" for the required format). Remove the current diskette and insert the diskette in question in the diskette drive. After 15 seconds, key and*

enter 031 7. The first 64 bytes of the record (0 to 3F), in hexadecimal characters, will be displayed. If this is a valid IBM 3600 diskette, the first 10 characters will contain E5D6D3F1 (VOL1) XXXXXX, where XXXXXX is the VOLID in hexadecimal. To display the next 64 bytes (40 to 7F), press the EM (enter) key. Location 75 (4B) should contain an F1, which indicates this is a properly formatted diskette. Anything other than an F1 causes a 90077 error message, and the diskette cannot be used for the create diskette function. The diskette format service program can be used to reinitialize a diskette so that it can again be used for the create diskette function.

#### Create Diskette Error Messages

| Message | Meaning  |
|---------|--|
| 90071   | Invalid or unexpected response or input received from the host.  |
| 90072   | An error was detected during a read operation to the host.   |
| 90073   | Contact with the host was lost during a read or write operation.   |
| 90074   | An error was detected during a write operation to the host.  |
| 90075   | The image just received from the host used all the space on the diskette just created. No tracks are available for the temporary file.   |
| 90076   | The controller was unable to establish a session with the host.  |
| 90077   | This message means either: <ol style="list-style-type: none"> <li>1. The diskette inserted in the diskette drive is not formatted correctly, or</li> <li>2. The diskette does not contain a previously created 3600 system when attempting to add or replace an application program.</li> </ol> This message will be followed by a 00012 or 00015 message. |
| 90078   | The controller was unable to load a create diskette overlay.   |

#### Notes:

1. All error messages except 90077 terminate the load.
2. A complete error message is in the following format:

*9007X AAAA BBBB CC DDDD ZZZ . . . Z*

*AAAA = Device status bytes*

*BBBB = CPU read control field*

*CC = Communication link status byte*

*DDDD = CPU write control field*

*ZZZ . . . Z = First 20 bytes of data in input/output segment*

All characters after 9007X are in hexadecimal. Refer to the *IBM Finance, Communication System: Instructions and Macros Reference*, GC27-0003, for device status bytes information, and to the *Programmer's Guide and Component Descriptions, Vol. 1*, GC22-9045, for information about the remaining fields.

3. *When errors occur that require a negative response to the host, four bytes of sense data must also be sent. The following bytes can be sent by the controller create diskette function:*
- a. *X'08 0A 00 00' – Bind command for other than Subsystem Support Services (SSS) was received.*
  - b. *X'00 00 C7 00' – An error occurred while reading or writing the diskette being created.*
  - c. *X'00 00 CD 00' – The RU command received from SSS is one that is not supported or that is invalid.*
  - d. *X'00 00 D3 00' – The Key List Index received is not greater than the previous one.*
  - e. *X'00 00 D4 00' – The parameter list data in the RU command is invalid.*
  - f. *X'00 00 D5 00' – Protocol error; an unexpected message was received.*

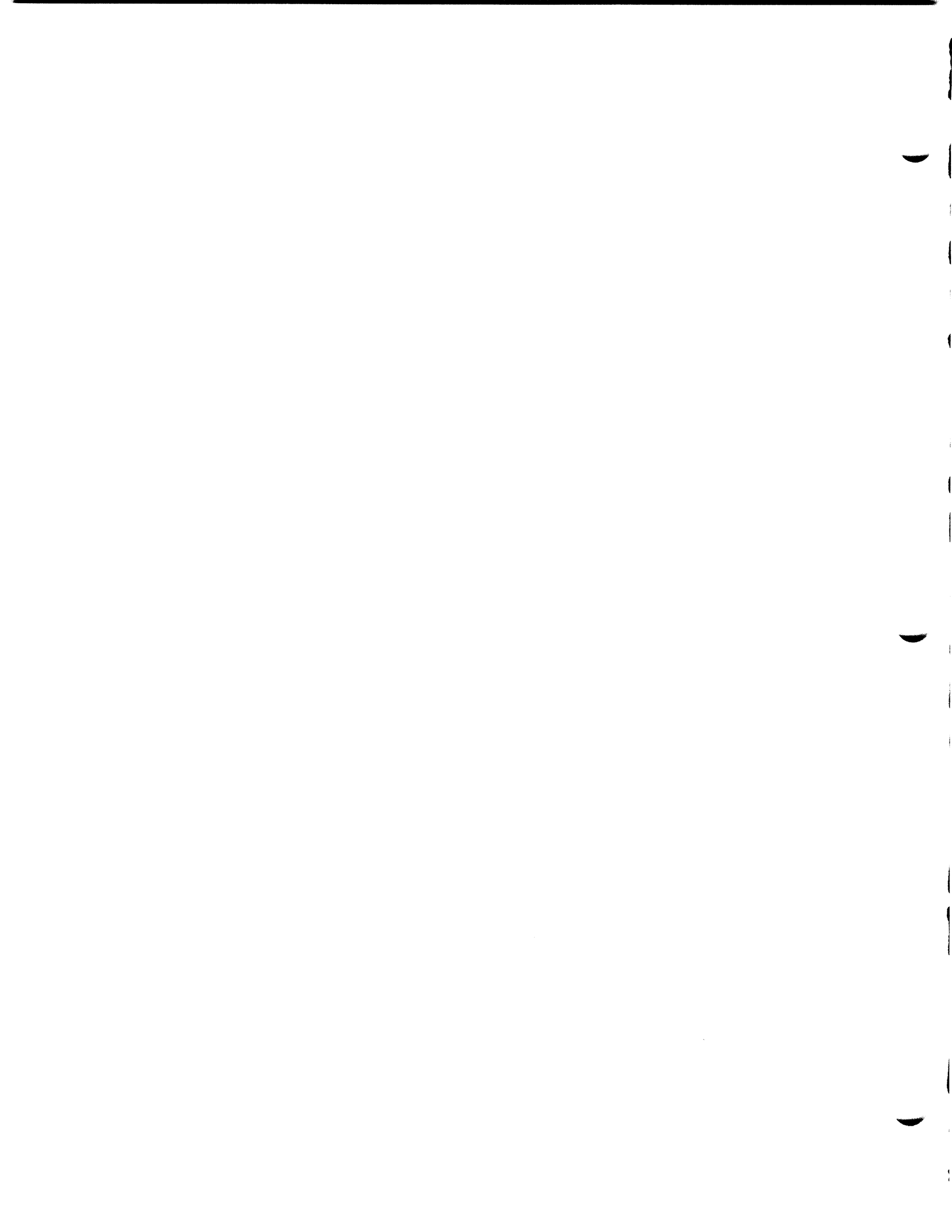


## Contents – Diskette Formatting

|   |   |
|---|---|
| General . . . . .                                     | 1 |
| Typical Procedure for Formatting a Diskette . . . . . | 1 |

DISKETTE FORMATTING

This page precedes the System Operating Procedures, Diskette Formatting page 1.



## Diskette Formatting

### GENERAL

The diskette format service program allows you to format or reinitialize a diskette so that it may be used in a 3600 system controller. This function is available only on the starter diskette, and it uses the 3604 at address 1 on loop 1 for the "control operator 3604."

While the diskette formatting function is active, no other system monitor functions are allowed; the system must be reloaded at the completion of the formatting. Enter only the responses to the prompt messages that appear on the 3604 display. One of the prompt messages will tell you to remove the starter diskette and insert the diskette to be formatted into the controller. The proper formatting information will then be placed on the diskette.

### TYPICAL PROCEDURE FOR FORMATTING A DISKETTE

Although your institution will prepare its own procedure for formatting a diskette, the procedure below is a typical example. The tables below list diskette formatting prompt messages, the actions required on your part, and the 70000, 70090, and 720XX error messages that can appear *only* during diskette formatting. If other messages appear, refer to "Messages" under "General Operating Procedures."

1. **Insert the starter diskette and press the RESET switch on the controller.**

Follow the rules for using the starter diskette. (See "Startup of the 3600 System.")

2. **The 3604 displays the diagnostic test messages.**
3. **When loading is complete, the 3604 displays the startup message (00001).**
4. **Key and enter 0 70 in response to the 00001 message**

0 70 is the diskette format service program.

5. **Wait for the 70001 message.**
6. **When the 70001 message appears, remove the starter diskette and insert the diskette to be formatted in the diskette drive.**
7. **When the 70002 message appears, enter either 0 or 1.**

0 means 128-byte records; 1 means 256-byte records.  
(The cursor will appear on the first line.)

8. **Wait for the 70003 message and then the 70001 message.**

The 70003 message means formatting is complete.  
(The display will be blanked just before the 70003 message is displayed.)

9. When the 70001 message appears, remove the formatted diskette.
10. If another diskette is to be formatted, insert it in the diskette drive and go back to step 7. If no other diskette is to be formatted, reload the system.

**Diskette Formatting Prompt Messages**

| Message | Meaning  | Actions   |
|---------|--|---|
| 70001   | This message is a request to remove the starter diskette and insert the diskette to be formatted in the diskette drive. If this message follows the 70003 message, it is then a request to remove the already formatted diskette and to insert another diskette to be formatted. | Remove the diskette in the controller diskette drive and insert another diskette. No operator response is required until, after about 10 seconds, the 70002 message is displayed.   |
| 70002   | This message is a request to enter the desired record size.  | Key and enter 0 or 1.<br>0 = 128-byte records;<br>1 = 256-byte records<br><br>If the entry is not valid, the 70002 message will be displayed again and until a valid entry is made.<br><br>After the EM (enter) is pressed, the diskette drive should move to track 0 and start the formatting. |
| 70003   | The diskette in the diskette drive has been formatted.<br><br>The format of the 70003 message, if there is a surface defect, is:<br>70003 TT0 TT0<br>TT = defective track number in decimal.   | No operator response is required until the 70001 message is displayed.<br><br>If a defective track number(s) is displayed, use of this diskette for an operational diskette is not recommended.   |

### Diskette Formatting Error Messages

| Message | Meaning   | Actions  |
|---------|---|--|
| 70000   | Controller error.   | Same as for 82000 message (see "Messages").  |
| 70090   | An error has been detected while trying to format the diskette.   | This message is followed by the 70001 message; open and close the diskette drive door to try again to format the diskette in the diskette drive; otherwise, replace the diskette.        |
| 72000   | Controller error during loading of the diskette format service program.   | Reload the system and, if the message occurs again, call the service representative and report the displayed message.  |
| 72070   | The control storage may be too small.   | Reload the system; if the message occurs again, diskette formatting is not possible in this system.  |
| 72076   | The diskette format service program could not be found.   | Insert a starter diskette with the program and reload the system.  |
| 72080   | After the controller data was loaded into storage, a check-sum error was detected. The controller data on the diskette was probably changed and cannot be used. | Reload the system; if the error occurs again, try another starter diskette. If the error still occurs, a probable controller error is indicated. See the 82080 message under "Messages." |
| 72090   | A diskette read error occurred.   | Same as 72080.   |

#### Notes:

1. *Formatting is terminated by an error message.*
2. *A complete 70090 error message is in the following format:*

*70090 AA B C D E F G H I*

*AA = Error code:*

- 00 – Unable to start formatting.*
- 06 – Track 0 write error.*
- 12 – Unable to format diskette.*
- 16 – Unable to write track 0 control records.*

*B = 1 – Intervention required. Indicates the diskette drive door was opened during formatting.*

*C = 1 – Command reject. A malfunction or controller error occurred.*

*D = 1 – A record could not be found during a read-back check.*

*E = 1 – Bad cyclic redundancy check (CRC).*

*F = 1 – Bad diskette. It does not meet 3600 system requirements.*

*G = 1 – Hardware malfunction. An asynchronous interruption from the diskette was lost.*

*H = 1 – Seek failure. The desired track could not be located.*

*I = 1 – Overrun. One or more data bytes entering the controller were lost.*



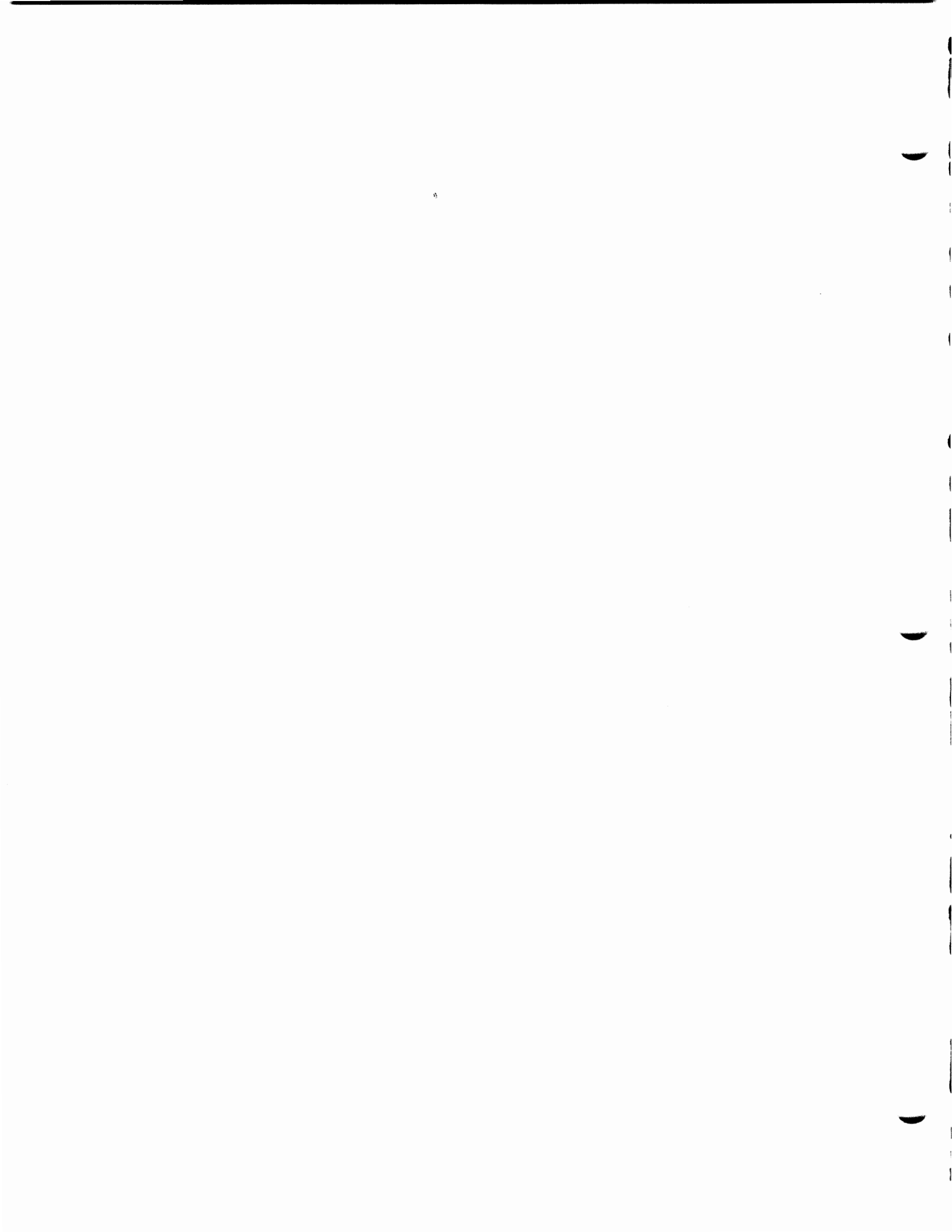
3. *The only entry permitted is a 0 or 1 response to the 70002 message. These keys are defined by the universal translation table.*
4. *Unrequested input should not be entered, but if it is, a number of results are possible. Most of the time, the keyboard is not enabled for input and if a key is pressed during this time, action will be delayed until the keyboard is enabled. When read, the entry is displayed and then discarded, or, under certain circumstances, formatting is terminated (perhaps incomplete), and the 70001 message is displayed.  
If the entry is immediately displayed, the system waits for the EM (enter) key to be pressed before continuing.*
5. *If formatting is interrupted by opening the diskette drive door, and the 70090 message is not displayed, it is necessary to reload the system.*

## Contents – Transmit Diskette

|   |   |
|---|---|
| General . . . . .                                       | 1 |
| Identifying the TTRRs . . . . .                         | 1 |
| Typical Procedure for Transmitting a Diskette . . . . . | 2 |

TRANSMIT DISKETTE

This page precedes the System Operating Procedures, Transmit Diskette page 1.



## Transmit Diskette

### GENERAL

The transmit diskette facility allows diskette records to be transmitted to the host system. This function is available on the starter diskette or with some system monitor versions. The data that can be transmitted is specified by track and record (TTRR) numbers. Permanent storage records, user programs, and the temporary file area are transmitted by specifying a beginning and ending TTRR for the required record(s). (Individual temporary file records within a block cannot be sent.)

Any properly formatted 128- or 256-byte diskette, one- or two-sided, can be sent to the host system. With a two-sided diskette, cylinder mode is used (except for the controller dump); that is, a track on side 0 is sent followed by the same track on side 1. Three different length records can be transmitted:

1. 256 bytes — all records other than those following;
2. 128 bytes — track 0 on 3600-formatted diskettes or all records on a 128-byte formatted diskette.
3. 6 bytes — control records found on any diskette.

Its format is : DELXXXXYY

Where: XXXX = 0080 for 128-byte records;  
          0100 for 256-byte records.

      YY = first character of the record.

### IDENTIFYING THE TTRRs

The beginning and ending TTRRs of the extents of permanent storage, user programs, and the temporary file can be obtained by using the 031 command to display track 2, record 1. Enter 031 0201. After the first 64 bytes of TTRR 0201 are displayed, press the EM (enter) key once. The display will now show the required TTRRs in the following format:

```
X0201 0201 0 — 0040
XXXX XXXX XXXX XXXX XXXX XXXX XXXX XXXX
AAAA BBBB XXXX XXXX XXXX XXXX XXXX XXXX
CCCC DDDD XXXX XXXX EEEE FFFF XXXX XXXX
XXXX XXXX XXXX XXXX XXXX XXXX XXXX XXXX
```

Where: AAAA BBBB = permanent storage beginning and ending TTRRs.  
      CCCC DDDD = user programs beginning and ending TTRRs.  
      EEEE FFFF = temporary file beginning and ending TTRRs.

## TYPICAL PROCEDURE FOR TRANSMITTING A DISKETTE

Although your institution will prepare its own procedure for transmitting a diskette, the procedure below is a typical example. The tables below list transmit diskette prompt messages, the actions required on your part, and the 90061 to 90066 error messages that can appear *only* during transmitting a diskette. If other messages appear, refer to "Messages" under "General Operating Procedures."

1. **Insert the starter diskette and press the RESET switch on the controller.**

Follow the rules for using the starter diskette. (See "Startup of the 3600 System.")

2. **The 3604 displays the diagnostic test messages.**
3. **When loading is complete, the 3604 displays the startup message (00001).**
4. **Key and enter 8 in response to the 00001 message.**

8 is cold start with no start link command given.

5. **Wait for the 92222 message.**
6. **When the 92222 message appears, enter the 041 0 command to start the link.**

See the 041 command for the parameters to be specified to describe the link being used.

7. **Key and enter 888 to activate the transmit diskette function.**
8. **When the 00091 message appears, insert the diskette with the data to be transmitted in the diskette drive.**

When the diskette is ready, the VOLID is displayed on the next line.

9. **When the 00092 message appears, enter the identifiers for the data to be transmitted.**

Enter one of the following:

(X)TTRR (X)TTRR – the beginning and ending TTRRs.

0 – transmit the entire diskette.

EM (enter) key only – transmit controller dump.

3801 3812 – transmit the controller operational information on dump diskettes.

10. **When the 00093 message appears, enter either 0 or 1.**

0 means the host will initiate the session; 1 means the 3600 system will initiate the session to SYSSSS. During transmission, the 3604 will display the TTRR and side of the record just transmitted.

11. When the 00099 message appears, transmission is complete or terminated by an error.
12. If another diskette or records are to be transmitted, go back to step 7. If the transmissions are finished, remove the transmitted diskette and reinsert the starter diskette.
13. Wait about 15 seconds, then enter the 042 0 command to start the diskette.

If the correct diskette was mounted, no error messages will appear and normal operations can continue; other system monitor commands can be entered without reloading the system.

#### Transmit Diskette Prompt Messages

| Message | Meaning   | Action  |
|---------|---|---|
| 00090   | This message is a response to the RE (reset) key being pressed twice.                                   | Key and enter 0 or 1.<br>0 = continue transmissions;<br>1 = terminate transmission.   |
| 00091   | This message is a request to insert the diskette with the data to be transmitted in the diskette drive. | Remove the diskette in the controller diskette drive and insert the diskette to be transmitted.   |
| 00092   | This message is a request to enter the identifiers for the data to be transmitted.                      | Enter one of the following: <ul style="list-style-type: none"> <li>• (X)TTRR (X)TTRR – beginning and ending TTRRs.</li> <li>• 0 – transmit entire diskette.</li> <li>• EM (enter) key only – transmit controller dump.</li> <li>• 3801 3812 – transmit the controller operational information on dump diskettes.</li> </ul> |
| 00093   | This message asks: Who will initiate the session, the host or the controller?                           | Key and enter 0 or 1.<br>0 = host will initiate session;<br>1 = controller will initiate session to SYSSSS.   |
| 00099   | Transmission is complete.   | All other system commands are now valid.  |



## Transmit Diskette Error Messages

| Message | Meaning  |
|---------|--|
| 90061   | Invalid or unexpected response or input received from the host.  |
| 90062   | An error was detected during a read operation to the host.       |
| 90063   | Contact with the host was lost during a read or write operation. |
| 90064   | An error was detected during a write operation to the host.      |
| 90066   | The controller was unable to establish a session with the host.  |

### Notes:

1. *All error messages terminate the transmission.*
2. *A complete error message is in the following format:*

*9006X AAAA BBBB CC DDDD ZZZ . . . Z*

*AAAA = Device status bytes*

*BBBB = CPU read control field*

*CC = Communication link status byte*

*DDDD = CPU write control field*

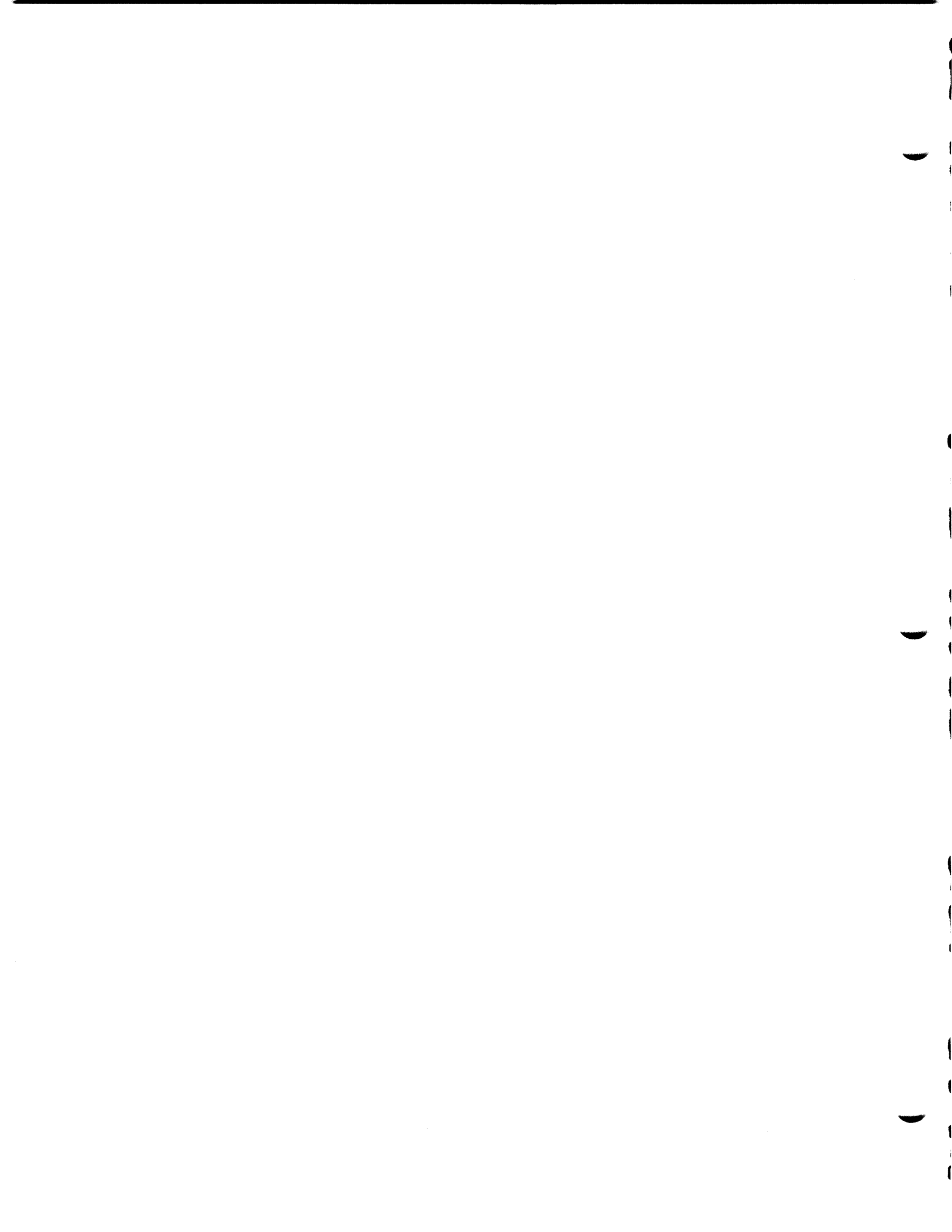
*ZZZ . . . Z = First 20 bytes of data in input/output segment*

All characters after 9006X are in hexadecimal. Refer to the *IBM Finance Communication System: Instructions and Macros Reference*, GC27-0003, for device status bytes information, and to the *Programmer's Guide and Component Descriptions*, GC27-0004, for information about the remaining fields.

## Contents – Display/Print Controller Log

|                        |   |
|------------------------|---|
| General . . . . .      | 1 |
| Log Messages . . . . . | 1 |

This page precedes the System Operating Procedures, Display/Print Controller Log page 1.



# Display/Print Controller Log

## GENERAL

The controller log is a temporary file located on the diskette. The controller places messages in this log that relate to maintenance and engineering data. Your institution's programs also have the ability to place messages in this log. The maximum message size is 252 bytes.

**Note:** *The controller log is lost by:*

- a. *a cold start,*
- b. *a reset temporary file request by the application program, or*
- c. *an 063 command to reset the temporary file.*

*It is not lost by a warm start.*

Controller log messages generated by the controller are stacked in a queue (waiting line). From there the log messages are written on the diskette any-time the diskette is not busy. Up to four log messages can be stacked in the queue. If messages are generated faster than they can be written on the diskette, those generated while the queue is full will not be written on the log.

The format of the messages, when displayed by the system monitor, is as follows: MMMM XY ZZZ DATA

MMMM = The four-digit message sequence number. Message sequence numbers are assigned in the order in which they are written. (The message sequence number is not part of the message; it is put on by the system monitor when displaying or printing the message.)

XY = Significance. These two digits are significant:

X = 1 means a controller-written log message.

X = Not 1 means a user-written log message. The user should not start the message with a 1.

Y = 1 means the log message requires *immediate* attention. To alert you to the presence of such a message, the controller turns on the Log Message light on the control operator's 3604 that was used during startup.

Y = Not 1 means the log message does not require immediate attention and does not turn on the Log Message Light.

**Note:** *The Log Message light is defined during the configuration generation process. It can be any one of the four lights (CHECK, 1, 2, or 3), with the CHECK light being the default.*

ZZZ = Message type.

DATA = The message information.

Your institution's log messages can have any format.

You can examine a display or a printout of the controller log by logging on at any operating 3604 and then giving a 001, 002, or 046 command as described in "Complete Commands."

When displaying and paging down the log by repeatedly pressing the EM (enter) key after entering the 001 command, the controller will display message 90001 if the EM (enter) key is pressed after message number one has

been displayed. When paging through the log by means of the 001 command, the 4-digit log message number and a space plus the first 35 bytes of the message are displayed. To display the full text, enter 002, space, and the message number. If the message is longer than the display size, the first line(s) of the message will be replaced by the last line(s) of the message. To see the full text, use the 046 command to send the message to the output printer.

## LOG MESSAGES

The controller places the following types of messages in the controller log:

- 11 001 \*\* 900XX SSSS \*\*

900XX = Control operator message number XX; see "Messages."

SSSS = Two status bytes displayed as four hexadecimal characters.

See "Complete Commands" and "Messages" for details.

- 10 002 AA BBBBBB CCCCCCCC DDDDDD EE FF GGGG,

A = The control code supplemental version ID.

B = Volume identification (VOLID)

C = Configuration generation identification (GENID).

D = The EC level of the controller data.

E = Control unit address (CUA).

F = Relocate count. A count of the number of the diskette records moved to the error track because of diskette surface defects.

G = Session identification (ID). The number of cold starts since the diskette was created.

On a cold start, message 10 002 is placed in the log and the session identification is incremented. On a warm start, message 10 002 is placed in the log but the session identification is not incremented.

- 11 003 NNNNNNNN SS PP AAAA CCCC IIII

N = Application program name.

S = Work station identification in hexadecimal.

P = Program check code in hexadecimal.

A = Program check address in hexadecimal.

C = Loop threshold count in hexadecimal (number of AP instructions executed since last exit).

I = First two bytes of instruction. If PP = 0B (user's instruction counter invalid), IIII is not valid data.

The above information is related to your institution's application program.

- 11 004 . . . . .

This message contains design support information found in the 82000 message. The service representative may request this information when aid is required to correct a problem. This message will appear only once when the diskette is used to start the system after it was stopped by an 82000 error.

- 11 005 LOOP X ERROR, CODE = Y – Z

X = Loop number.

Y = Loop status:

0 = The controller loop control card and the modem (if a remote loop) passed the wrap test.

1 = Modem failed wrap test.

2 = Controller loop control card failed wrap test.

4 = Machine check.

6 = Combination of 2 and 4.

8 = User requested stop loop.

Z = Line status (600-bps loops only):

0 = Transmit and receive not ready.

1 = Receive ready (carrier detect).

2 = Transmit ready (clear to send).

3 = Combination of 1 and 2.\*

\*Line status of 3 indicates the modem is operational. Any other status implies a modem or telephone line failure; see "Problem Recovery Procedures."

- 11 006 (host link error message) has three formats:

Format 1: 11 006 A

A = 0. An error condition caused the controller to run wrap tests, and they were successful. The controller automatically wrap-tests the modem if it is a wrappable modem and it was defined as such in the configuration generation process. The controller may or may not automatically wrap-test an external modem. This is determined by each institution's configuration image and the external modem capability.

A = 2. A stop link command was issued by the system monitor or your institution's application program.

Format 2: 11 006 AXXXBXXXXXXXXXXXXX

A = 1. An error condition caused the controller to run wrap tests, and they were not run successfully. The service representative should be called:

If B = 9, the adapter failed.

If B = D, the modem failed.

Format 3: 11 006 ASSSSSSTTTTXXTTTTTTRRRRRRCC

**Note:** *The 28 hexadecimal characters that follow A are for programming information.*

A = 3. A message was received in error. If ASSSS = 38004, XX means the station does not exist. All other occurrences of this message indicate a network error.

S...S = Sense returned to the host, if possible, on a bad message.

T...T = Transmission header of the failing message.

R...R = Request header of the failing message.

CC = First byte of the request unit.



See Appendix A, "Communication Sense Codes," in the *3600 Programmer's Guide and Component Descriptions, Vol. 1, GC22-9045*.

- 11 007 CCFFIIAAIDIDSSSSBBBBXXXXYYYY

CC = code identifying the type of error:  
X'01' = Initialize failure.  
X'02' = Fixed head refresh failure.  
X'03' = Label read error.  
X'04' = DSCB extent conflict found.  
X'05' = Surface format is not valid.\*  
X'11' = DSCB I/O error.

FF = the logical adapter function requested:  
X'00' = Initialize disk.  
X'06' = Write sector.  
X'07' = Read sector.  
X'40' = Assign alternative sector.  
X'42' = Write ID.  
X'43' = Read ID.  
X'46' = Write displaced ID.  
X'47' = Read displaced ID.

II = the data set ID being referenced, if any.

AA = the physical adapter address.

IDID = the sector physical address in error:  
Bits 0–9 = track number.  
Bits 10–15 = sector number.

The remainder of this message contains design support information. The service representative may request this information when aid is required to correct a problem.

- 11 010 X

X = error return code:  
X'1' = Link adapter type unknown.  
X'2' = Link module requested cannot be found.  
X'3' = Default taken, but no link module matches adapter.

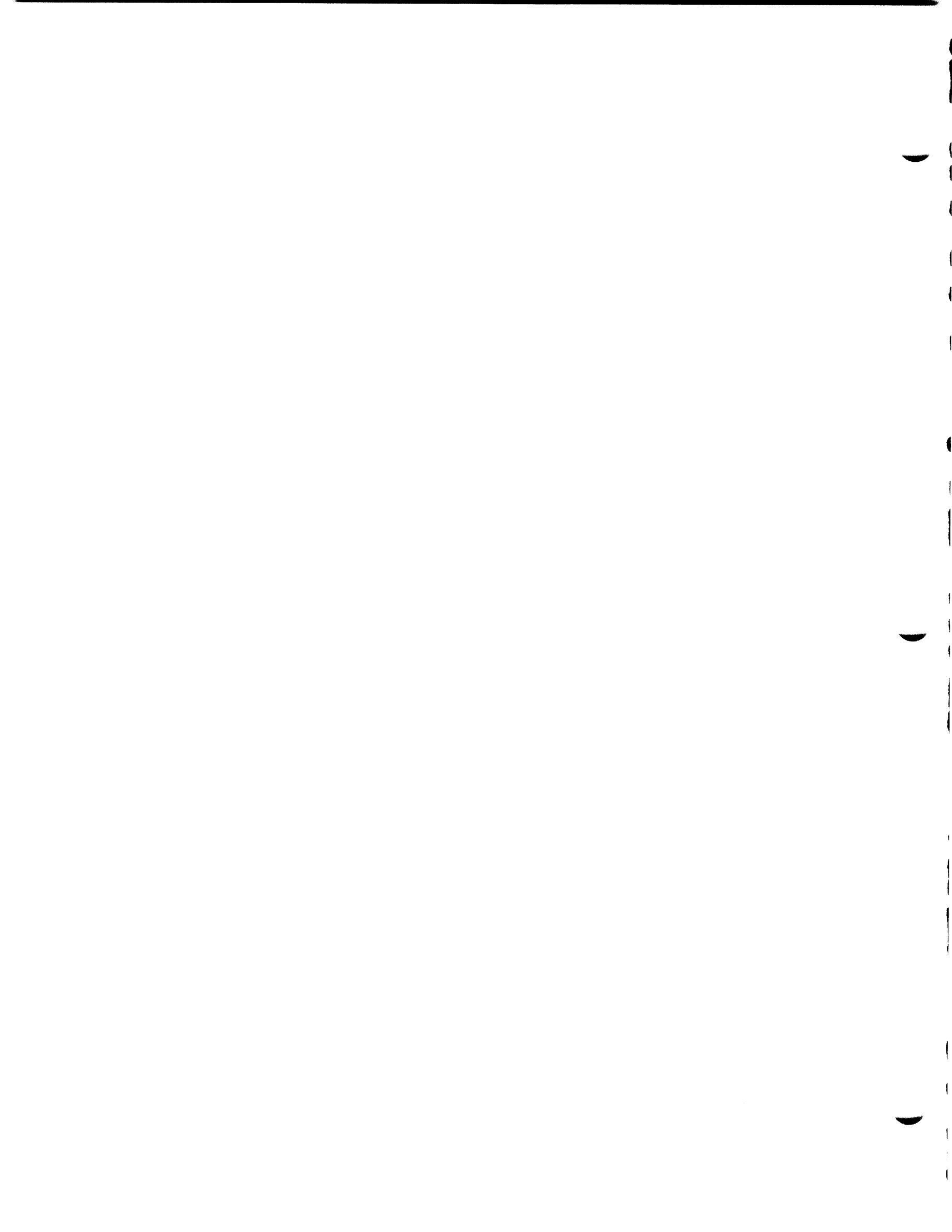
\*The disk file's surface format is not correct. To reformat the surface correctly, run the Clearing the Initial Tracks and then the Reformatting Sector facilities; see Disk File Error Recovery Procedures.

- 10 030 DATA

DATA is any text up to 176 characters, keyed in by the control operator for a diskette test. Refer to the 030 command in "Complete Commands."

If an attempt is made to write log message 030 while you are logged on and the log area is full, the controller will display message 90012 4000 or 90012 5000.

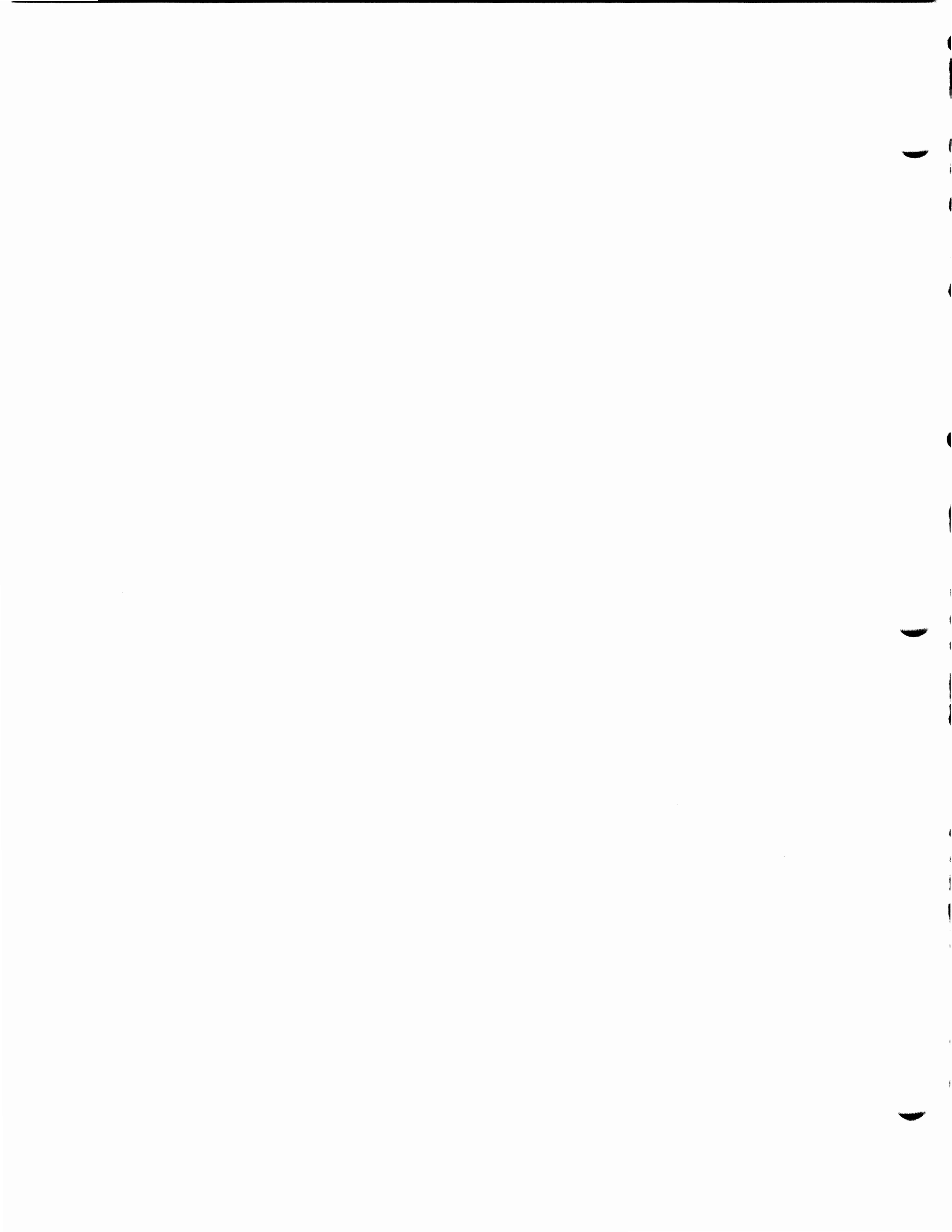
- Any other messages were written by the institution's application programs by means of a Write to Log command, and the institution's procedures should be followed.



## Contents – Display/Print Statistical Counters

|  |   |
|--|---|
| General . . . . .                          | 1 |
| Host Communication Link Counters . . . . . | 2 |
| Diskette Counters . . . . .                | 5 |
| Disk File Counters . . . . .               | 5 |
| Loop Control Counters . . . . .            | 7 |
| Terminal Component Counters . . . . .      | 7 |

This page precedes the System Operating Procedures, Display/Print Statistical Counters page 1.



# DISPLAY/PRINT STATISTICAL COUNTERS

## GENERAL

In addition to recording errors in the controller log, the controller maintains statistical counters for each of the following components of the system:

- controller host communication link
- controller diskette
- controller disk file
- controller loop control (for each loop)
- 3604 keyboard
- 3604 display
- 3604 magnetic stripe encoder
- 3606 or 3608 keyboard, display, and magnetic stripe reader
- 3608 printer
- 3610 document printer
- 3611 passbook printer
- 3612 document printer
- 3612 passbook printer
- 3614 Consumer Transaction Facility
- 3618 printer

### Notes:

1. *Statistical counters count events at components at terminal addresses. Units in terminal groups are collectively counted by counters associated with the common terminal addresses. For example, five 3606s in a terminal group at terminal address 7 will be counted as if they are one 3606 at terminal address 7. The counters, thus, do not distinguish between subaddresses within the terminal group.*
2. *The events counted include hardware errors (for example, machine failures) and improper operations (for example, incorrectly passing a magnetic stripe card through the magnetic stripe reader), or provide information (for example, indicating an out-of-forms condition or that the STOP PRINT key was pressed).*
3. *The statistical counters are located in functional storage and are lost each time there is a startup (reset). In contrast, the controller log is located on the diskette. Thus, this log is lost only on a cold start or a reset of the temporary file.*

After logging on at a 3604, key in either of two commands to obtain the statistical counts:

1. 010 LSSDD to display the statistics of a specified component.
2. 012 X to print the statistics for all components on the assigned output printer. X is the number of loops attached to the controller. See the 010 and 012 commands for the format.

The *output format* for the statistical counters of any component is:

LSDM TT SS XXX XXX XXX . . . . ., where:

- L = loop number (1–8).
- S = terminal address in hexadecimal.
- D = component address in hexadecimal.
- M = modulus value for a terminal component, or the speed of a loop (see below).



TT = component type (see below).  
SS = work station identification (not applicable for non-terminal components).  
XXX = count in decimal.  
LSD0 = 9010 for host link.  
LSD0 = 9020 for diskette.  
LSD0 = 9100 for disk file.  
LSD0 = X0YY for loop control where X = number of the loop.

If YY = loop speed, values are as follows:

01 = 4800 bps  
02 = 2400 bps  
04 = 1200 bps  
08 = 600 bps  
8X = this loop is used for clocking.

Component types (TT) are as follows:

01 = host link  
02 = diskette or disk file  
80 = loop control  
81 = keyboard  
82 = display  
83 = 3610, 3611, or 3612 printer  
85 = 3618 printer  
86 = 3604 magnetic stripe encoder  
87 = 3614 terminal  
88 = 3606 or 3608 keyboard, display, and magnetic stripe reader  
89 = 3608 printer

Concerning the counters, note that:

1. Each XXX represents the decimal count in one counter. The counters are designated as counter 1, counter 2, etc., from left to right.
2. If a counter reaches 256, additional statistics of that type will cause the counter to return to 128 and continue from there. Thus, counts of 128 or over are not definitive.
3. Counts represent the number of events, not the number of retries per operation. A single event may increment more than one counter.

## HOST COMMUNICATION LINK COUNTERS

*Counter*      *Stepped By:*

- 1\*      A Set Normal Response Mode (SNRM) or a Set Disconnect Response Mode (SDRM) SDLC command has been received. The SNRM is used for the initial contact on the link while SDRM is the final transmission on the link. Hence, after the controller makes contact with the host, this counter will be 1. If the cluster is subsequently deactivated, the count will be incremented by 1. For user information.

---

\*This counter provides information for programmer use.

*Counter Stepped By:*

- 2 If the 3704/3705 diagnostics which use the Send Test Message function are loaded, each SDLC test message (denoted by a special SDLC command) received without error by the controller will be returned to the 3704/3705, and this counter will be incremented. If the test message is not received correctly, error recording continues as for any normal message. For service representative information.
- 3 Write retry. When the controller sends a message as the result of a poll from the 3704/3705, it waits for confirmation that the complete message was received. If this confirmation is not found, the controller resends the entire message and increments this counter. If a part of the message was received, the parts not received are re-sent, but this counter is not incremented. This is a soft error.\*
- 4 Timeout. The line has been inactive for a period of time specified by the user for the CPGEN on the CTG parameter in the COMLINK macro, the adapter is reset, an automatic wrap test is performed, and this counter is incremented. If the wrap test is not successful, a message is recorded in the controller log, and the adapter is disabled. If the wrap test is successful, a message is also recorded in the controller log, and the controller waits for traffic on the line; any subsequent timeouts are ignored until communication is restored. This is a hard error on the line.\*
- 5 Overrun. One or more data bytes entering the controller were lost because the controller was late in servicing a service request. This counter denotes a controller problem and should be reported. The error is corrected by the controller without loss of contact. This is a soft error; call the service representative.\*
- 6 Underrun. One or more data bytes leaving the controller were lost because the controller was late in giving data to a service request. This counter denotes a controller problem and should be reported. The error is corrected by the controller without loss of contact. This is a soft error; call the service representative.\*
- 7 Connection problem. In association with counter 3, if a complete message is resent more than a preset number of times, this counter is incremented. This is a hard error on the line.\*

---

\*A soft error means there is no interruption in the session. A hard error interrupts the session and the adapter is wrap-tested.

*Counter Stepped By:*

- 8 The interface between the hardware adapter and the controller data is incompatible. Either the adapter is malfunctioning or a data error is present. This is a hard error; call the service representative.\*\*
- 9\* Block check count (BCC). The cyclic redundancy check (CRC) failed for the last message received. Indicates a transient communication line error. This is a soft error on the line.\*\*
- 10 The controller detected an abnormal termination of a message by the host. This is a soft error on the line.\*\*
- 11\* Data communication equipment (DCE) error. Indicates a modem problem. This is a modem failure.
- 12\* Controller is busy because of no available receive buffers. Indicates a probable controller configuration procedure problem. For user information.
- 13\* A command reject condition that resulted from messages received out of sequence. Frame has good BCC. Indicates a message was lost. This is a soft error on the line.\*\*
- 14 Machine check. The hardware adapter is malfunctioning or not physically located in the controller. This is a hard error; call the service representative.\*\*
- 15 A command reject condition that resulted from receipt of a data field with an otherwise valid write command for which no data field is defined. Frame has good BCC. Indicates network error. This is a hard error; call the service representative.\*\*
- 16 A command reject condition that resulted from receipt of an invalid command in a frame which has good BCC. Indicates network error. This is a hard error; call the service representative.\*\*

---

\*These counters provide information for programmer use.

\*\*A soft error means there is no interruption in the session. A hard error interrupts the session and the adapter is wrap-tested.

## DISKETTE COUNTERS

*Counter      Stepped By:*

- 1      Intervention required. Indicates the number of times the diskette drive door was opened. The count can also indicate the diskette is not rotating or the speed is not within limits.
- 2      Command reject. The adapter malfunctioned or there was a controller error.
- 3      The record requested could not be found. An Absolute Read to Diskette was issued that contained a valid track number but an invalid record number, or, if the record number was valid, the diskette itself or its contents had been damaged and/or there was a hardware malfunction.
- 4      Bad cyclic redundancy check (CRC). There was a mismatch between the computed CRC and the CRC read from the diskette.
- 5      Bad diskette format. The diskette does not meet standards.
- 6      Diskette hardware malfunction. An asynchronous interruption from the diskette was lost.
- 7      Seek failure. The desired track could not be located. An Absolute Read to Diskette was issued but the track number was invalid, or, if the track number was valid, the diskette itself or its contents had been damaged and/or there was a hardware malfunction.
- 8      Overrun. One or more data bytes were lost entering the controller.
- 9      A diskette surface defect was encountered when attempting to write a data record in the temporary file area. The record is then written in the next sector.

**Note:** *Counts in counters other than 1, 3, and 7 may indicate a hardware malfunction. If, after changing the diskette, those counts still increase, notify your service representative.*

## DISK FILE COUNTERS

*Counter      Stepped By:*

- 1      Data bus out parity error.
- 2      Command reject. The adapter malfunctioned or there was a controller error.

| <i>Counter</i> | <i>Stepped By:</i>   |
|----------------|--|
| 3              | Seek error.  |
| 4              | Data unsafe.   |
| 5              | Read sync error.   |
| 6              | Sector ID error.   |
| 7              | Reserved.  |
| 8              | Bad sector.  |
| 9              | Write bit check.   |
| 10             | Data cycle error.  |
| 11             | Bad cyclic redundancy check (CRC) in the sector ID or sector data. There was a mismatch between the computed CRC and the CRC read from the disk. |
| 12             | Not ready.   |
| 13             | Busy.  |
| 14             | Machine check.   |
| 15, 16         | Reserved.  |
| 17–19*         | Total physical input/output operations requested.  |
| 20–22*         | Number of data set control block (DSCB) blocks read.   |
| 23–25*         | Number of DSCB blocks written.   |
| 26–28*         | Number of application program overlay blocks loaded.   |
| 29–31*         | Number of blocks initialized during data set allocation.   |
| 32–34*         | Number of physical read operations eliminated because requested block was already in user storage.   |
| 35–37*         | Reserved.  |
| 38–40*         | Reserved.  |

\*The count value is the value in the first counter (17, 20, 23, etc.), multiplied by 65,536; plus the value in the second counter (18, 21, 24, etc.), multiplied by 256; plus the value in the third counter (19, 22, 25, etc.).

**Note:** *Counts in counters 1 through 16 indicate a hardware malfunction. If counts consistently appear in these counters, notify your service representative.*

*Counters 17 through 40 are statistical counters that may be of value to the system programmer.*

## LOOP CONTROL COUNTERS

| <i>Counter</i> | <i>Stepped By:</i>   |
|----------------|--|
| 1              | Sync check. The counter is stepped if the loop goes out of sync <i>and</i> sync cannot be recovered within 12 tries, in a sequence of 8 valid frames and 2 bad frames. |
| 2              | Noise errors in loop return to controller. This counter is incremented for every 16 counts of bad data.  |
| 3              | Machine check during wrap test of loop control card.   |
| 4              | Error during wrap test of loop control card.   |
| 5              | Error during wrap test of modem.   |

**Note:** *When there are counts in any of these counters, check the controller log for a 11 005 message. (Refer to "Display/Print Controller Log" for details.)*

## TERMINAL COMPONENT COUNTERS

| <i>Terminal Component</i>       | <i>Counter</i> | <i>Stepped By:</i>  |
|---------------------------------|----------------|---|
| 3604<br>keyboard                | 1              | Common loop error*  |
|                                 | 2              | Common loop error*  |
|                                 | 3              | Keyboard overrun or magnetic stripe reader error. A keyboard overrun occurs when the operator keys in more than six characters while a write-to-the-display is in progress. A magnetic stripe reader error is caused by passing the magnetic stripe through the reader too fast or with an uneven motion. |
|                                 | 4              | Translation error. A translation error occurs when an input scan code is not found in the translation table for that keyboard.  |
|                                 | 5              | The application program segment specified in the LREAD was smaller than the amount of data entered.   |
| 3604<br>display                 | 1              | Common loop error*  |
|                                 | 2              | Common loop error*  |
| 3604 magnetic<br>stripe encoder | 1              | Common loop error*  |
|                                 | 2              | Common loop error*  |
|                                 | 3              | Unable to make the encoder ready or to successfully encode. When encoding, must write twice and then read back twice successfully before a good encode is indicated.  |

\*See note at end of listing.



| <i>Terminal Component</i>                                      | <i>Counter</i> | <i>Stepped By:</i>   |
|--|----------------|--|
| 3606 and 3608 key-board, display, and magnetic stripe reader** | 1              | Common loop error*   |
|  | 2              | Common loop error*   |
|  | 3              | Read timeout. If, after 2 minutes from the last read operation sent, no response was received, this count is incremented. Probable cause is a power off, then on, of the unit after SEND key was pressed.            |
|  | 4-9            | Reserved   |
|  | 10, 11††       | Total number of transactions received from the terminal or terminal group.   |
|  | 12, 13††       | Cumulative total of the number of transaction queued (unserviced) when another transaction is received. For example, if three transactions were queued and a fourth one is received, this count is incremented by 3. |
| 3608 printer   | 14, 15††       | Total number of transactions received from the terminal or terminal group while the work station is not idle.  |
|  | 16             | The greatest number of transactions queued at any one time.  |
|  | 1              | Common loop error*   |
|  | 2              | Common loop error*   |
| 3610, 3611, and 3612 printer                                   | 3              | Emitter check. Hardware error.   |
|  | 4              | The application program attempted to print a line longer than the specified form width.  |
|  | 5              | Interventions required. Caused by a forms jam, printing off end of form, no form, or cover open.   |
|  | 6              | Timeout. If, after 2 minutes from the last operation sent to the printer, no response was received from the printer, this count is incremented.  |
| 3610, 3611, and 3612 printer                                   | 1              | Common loop error*   |
|  | 2              | Common loop error*   |
|  | 3              | Intervention required. This indicates the cover is open or the STOP PRINT switch was pressed. Note that counter number 6 (platen open) is also incremented each time the STOP PRINT switch is pressed.               |
|  | 4              | Emitter check. The print wheel is not up to speed.   |
|  | 5              | End of formst  |

\*See note at end of listing.

\*\*Each counter is common to all like units in a terminal group.

†Models 3 and 10 of the 3610 and 3612 only.

††The count value is the value in counter 10 (or 12 or 14) multiplied by 256 plus the value in counter 11 (or 13 or 15, respectively).

| <i>Terminal Component</i>                        | <i>Counter</i> | <i>Stepped By:</i>  |
|--|----------------|---|
| 3610,<br>3611, and<br>3612<br>printer<br>(cont.) | 6              | Platen open, the STOP PRINT switch pressed, or hardware malfunction. If the count is less than, or equal to, the count in counter number 3 (intervention required), then the STOP PRINT switch was probably pressed that number of times. |
|  | 7              | Timeout (no response) from 3610, 3611, or 3612. This indicates a possible hardware malfunction. If, after 40 seconds from the last operation sent to the printer, no response was received from the printer, this count is incremented.   |
|  | 8              | Missing left margin indication after carriage return. Hardware error.   |
| 3614<br>terminal                                 | 1              | Common loop error*  |
|  | 2              | Common loop error*  |
|  | 3              | Read timeout. The data transfer during a read operation did not complete within 1 minute.   |
|  | 4-16           | Not used. Should be zeros.  |
| 3618<br>printer                                  | 1              | Common loop error*  |
|  | 2              | Common loop error*  |
|  | 3              | Hammer fire check, printer sync check, illegal order, or initialization check. Counter 4 or 7 may also be incremented.  |
|  | 4              | Hammer fire check. Hardware error.  |
|  | 5              | Forms motion check. Paper jam.  |
|  | 6              | Timeout. No response in 1 minute from 3618 after an operation was started.  |
|  | 7              | Printer sync check. Hardware error.   |
|  | 8              | End-of-forms, left, or right, or both left and right.   |
|  | 9              | Unsuccessful attempt to initialize the printer. Initialization takes place only after the printer has been stopped. Usually stepped because belt was not up to speed. An error only if printer fails to print properly.                   |
|  | 10             | Belt not up to speed  |
|  | 11             | Not used  |
|  | 12             | Cover or throat open  |

\*See note at end of listing.

### Footnote for "Terminal Component Counters"

\*Common terminal statistical counters (counters 1 and 2):

Counter 1 (Loop Related) – Status 0200.

Stepped if:

- a. The entire loop goes down during an input/output operation.
- b. An input/output operation is attempted and the loop is not yet started.

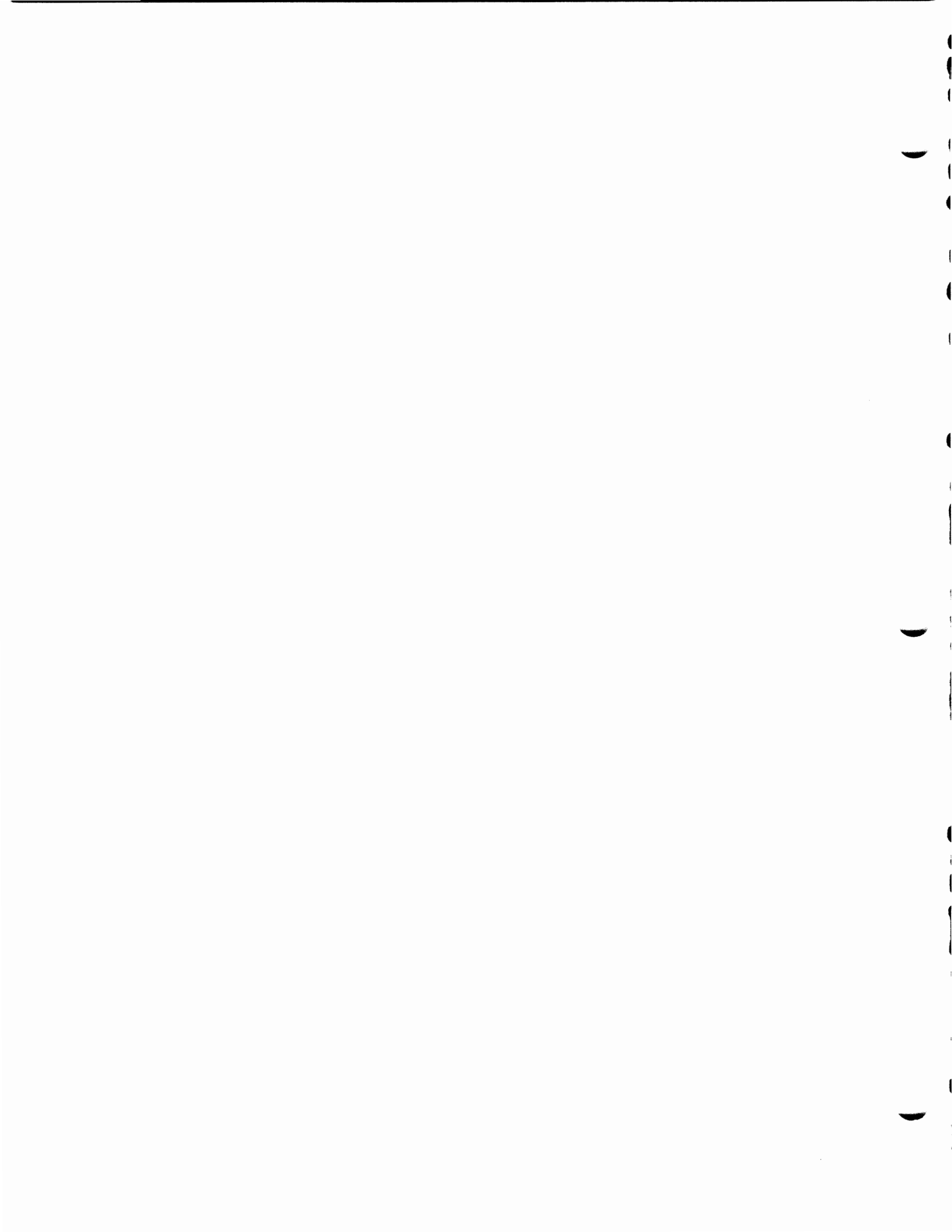
Counter 2 (Terminal Loop Adapter Related) – Status 0201.

**Note:** *If a terminal is powered off and an input/output operation (LREAD, LWRITE, or LCHECK) is attempted by the application program, a status of 0201 is returned and this counter is incremented for each attempt. Therefore, this count can get quite high if input/output operations are continued after the error is reported.*

This counter is stepped if:

- a. An input/output command is not acknowledged by the terminal loop adapter (for example, the terminal is powered off or a wrong address is set).
- b. Output data is not acknowledged by the terminal loop adapter (for example, the terminal is powered off or the terminal address is changed during operation).
- c. An attention is received from a component other than those indicated in the configuration generation process (for example, a 3604 on a 3612 address).
- d. An ambiguous situation arises during an input/output operation. This occurs when the state of the terminal loop adapter is unpredictable and a reset must be sent. (For example, turning power on or off on another component while operating causes a bit-shift and the data may be interpreted by the terminal loop adapter as a command.)
- e. An input/output request is made to a component whose terminal loop adapter has been previously determined to be not operational

This page precedes the System Operating Procedures, Application Program Modification page 1.



## Application Program Modification

The procedure to modify application programs (APs) on nonoperational diskettes (prior to IR4) is as follows:

1. Use the system monitor command 031 to display the volume record.

Example:

```
Enter
031 0201   where 0201 represents
           track 2, record 1
```

Press EM (enter) to get the second page of data. (X0201 0201 0 – 0040 will appear on the top line.) At a displacement of X'60' (third line down) is the starting track and record (TTRR), in hex, of the application program (AP). The next six bytes contain the ending TTRR, the number of records, and the number of bytes in the last record.

Example:

```
1707 1907 001F 0064 . . . . .
```

2. Calculating the displacement into the diskette for addresses not in an overlay:
  - a. Find the starting TTRR for the APs, as shown in step 1 above.
  - b. Find the address in your AP listing (if in an overlay, follow step 3) and add 16 (X'10') to it.
  - c. Divide the above address by 256 (X'100'), which yields the number of diskette records into the AP from the starting TTRR. The remainder is the number of bytes into the record where the data begins.
  - d. Add the calculated number of records to the starting TTRR to obtain the TTRR of the diskette record that contains the area you want to modify. (Remember there are 15 blocks per track on the diskette.)
  - e. If there is more than one AP on the diskette, find the first one, as described in step 1 above. Use the 031 command to display that record. The AP name, in hex, is 20 bytes (X'14') in from the beginning. The first four bytes are the total length of the first AP. Follow steps c and d, using the total length, to get to the next AP and display that address using the 031 command. The first four bytes, following the end of the first AP, are the length of the next AP. Continue this procedure until the correct AP is found.
  - f. At this point, you should use the 031 command to display the TTRR you have calculated to verify that you have found the record containing the data you want to change.
  - g. Use the system monitor command 032 to modify your AP (See 031 command to define diskette side to be used.)

Example:

```
Enter
032 2312 200 1A24
```

This entry will change the two bytes of data on diskette side 0 at TTRR address 2312 (X'170C'), at a displacement of 200 (X'C8') into the record, to X'1A24'. This entry could have used hex instead of decimal for the TTRR and DDD numbers.

If this command is issued using an operational diskette, a 90001 error message will be displayed.



3. Calculating the displacement into the diskette for addresses in an overlay:

The overlay directory follows the root on the diskette and then the overlays in the order in which they were specified. The root section is that part of the AP from the beginning up to the finish statement. There are two ways to locate overlays on the diskette: the first way is used if the APs are not in storage (starter diskette loaded); the second way is used if the diskette, containing the APs with overlays, has been loaded.

Overlays on the diskette:

- a. To find the first overlay, follow step 2, using the root length as the address. (Note: The root length, in hex, is 16 bytes in from the beginning of the AP on the diskette or in location 0 of the AP when in storage.)
- b. Immediately following the root section is the overlay directory, which consists of 16 byte entries, one for each overlay specified in the NUMOVLY parameter of the BEGIN statement. Multiply the number of entries by 16, add 2, and then add the result to the root length to get the displacement to the first overlay.
- c. Immediately following the directory is the beginning of the first overlay. The first two bytes of each overlay contain the length of the overlay. You can now use that length, added to the value from step b, as an address to get to the next overlay, and so on until you find the overlay you want.
- d. Find the address, in the overlay section, of the data you want to modify and subtract the overlay beginning address. The result is the number of bytes into the overlay that contains the data you want to change.
- e. Add the displacement into the diskette record of the beginning of the overlay to the results from d above.
- f. Divide the results from e above by 256 (X'100'), which yields the number of diskette records into the overlay from its beginning. Now follow f and g under step 2 above to modify the overlay.

Diskettes that have been loaded:

- a. The overlay directory is located at the end of segment 14. At location X'16' into the AP header is the displacement to the first overlay entry. There is one directory entry for each overlay with an X'FF00' following the last entry. Each entry contains the following:
  - Overlay name (8 bytes)
  - Beginning address of the overlay (2 bytes)
  - Reserved (2 bytes)
  - Starting TTRR for that overlay (2 bytes)
  - Displacement into record of beginning of overlay (1 byte)
  - Flag byte (1 byte)

- b. The overlay directory can be displayed by entering debug mode via the 123 command and then displaying segment 14 using the 01 command.

Example:

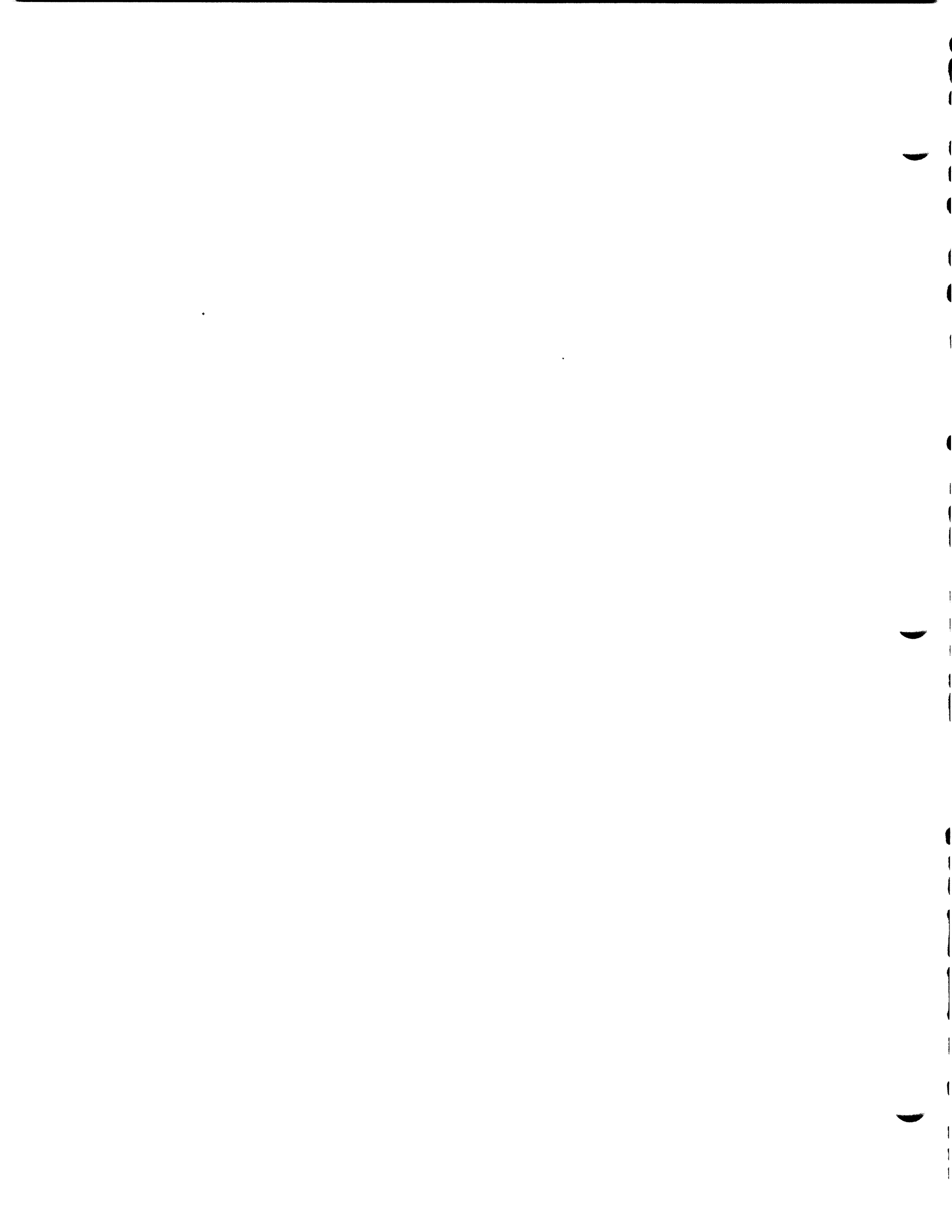
```
Enter: 123 X          X is the station ID.  
       01 14 22      22 is the displacement to the overlay directory.  
       01 14 XYYYYY  YYYYY is the displacement obtained in the above step.
```

The first eight bytes of the directory will be displayed. By pressing the EM (enter) key, the next eight bytes will be displayed. This can be done until the appropriate overlay entry is found.

From your listing, get the address, in the overlay, of the data you want to change.

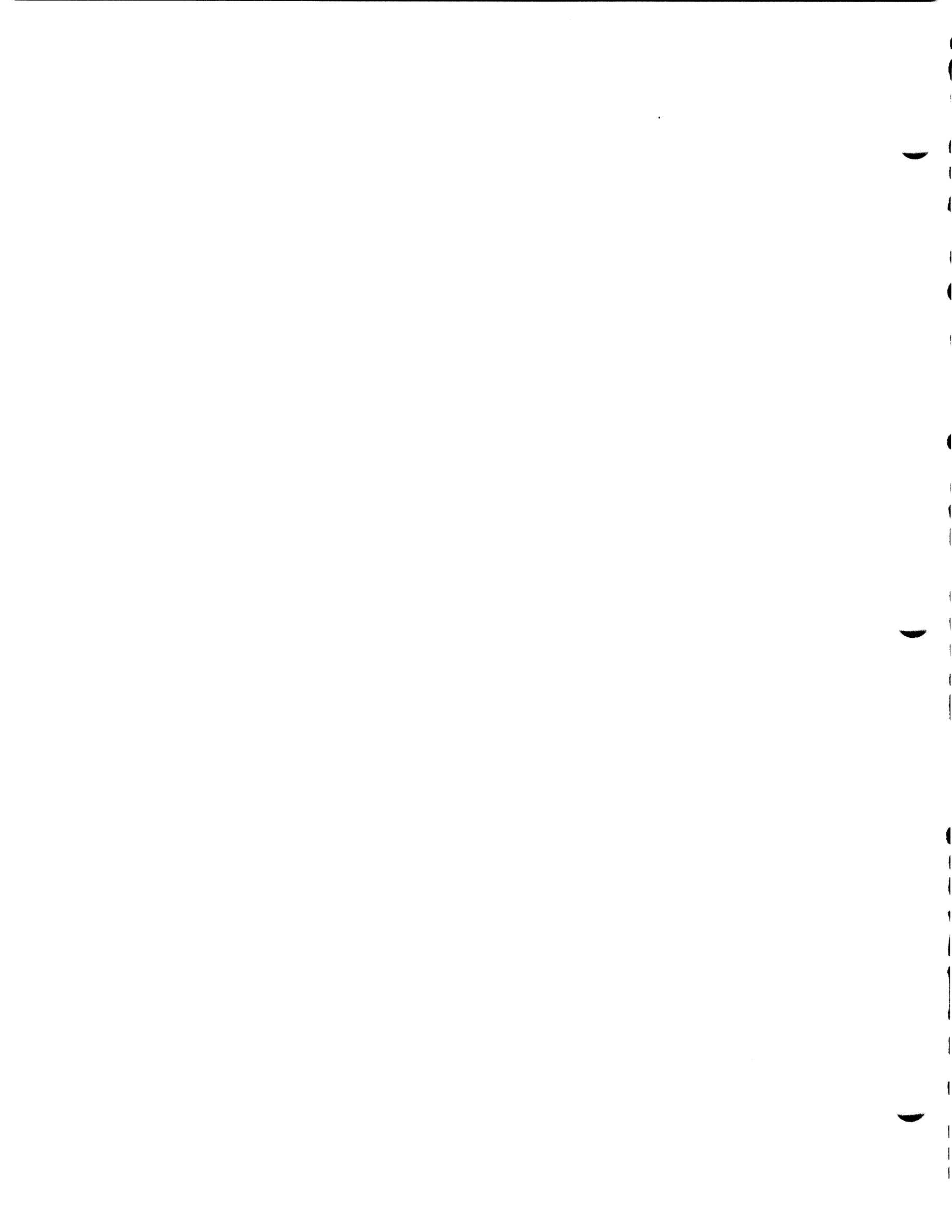
- c. Subtract the overlay beginning address, which is also found in your listing or in the directory; then add the displacement into the record which is obtained from the overlay directory.
- d. Leave debug mode, via 00 command, and then follow c and d under step 2 above, using the TTRR found in the overlay directory as the starting TTRR.

These changes are stored on the diskette only and do not become effective until the next system load or, in the case of an overlay change, until the overlay is next read from the diskette. If the application programs are stored on the disk file, these changes do not become effective until the next system load.



DEBUG MODE

This page precedes the System Operating Procedures, Debug Mode page 1.



## Debug Mode

After logging on as the control operator, key and enter 123 XX to place the controller in the debug mode. This mode allows you to perform online debugging (troubleshooting) of the logical work station identified by XX (one or two characters that can be obtained from the configuration documentation). The logical work station consists of: (1) the controller application program that runs a group of terminal components that form a physical work station, and (2) the storage area connected to the work station. This storage area may consist of as many as 16 segments (0–15).

While the debug mode is in effect, the two-digit debug commands described in the table below can be used, but the control operator commands *cannot* be used.

With reference to the table, note that:

1. The maximum size of each field is given. However, except for the two-digit command code, all fields are variable in length. The variable-length fields do not require leading zeros. Spaces must be used to separate each field.
2. The DATA fields must be entered in hexadecimal, with no spaces between fields.
3. All fields other than DATA are to be entered in decimal unless the field representation starts with (X). In this case, the field may be entered in decimal or hexadecimal. If you enter the field in hexadecimal, start the field with X. For example: to enter an address with a hexadecimal value of 1FB, key and enter any of the following:  
X01FB or X1FB (hexadecimal)  
00507 or 507 (decimal)
4. The 02, 10, or 12 command changes data only in storage. The data stays there until another 02, 10, or 12 command is issued to the same location, the system is loaded, or, if in an overlay section of an application program, another overlay is called in. Logging off does *not* cause the original data to be placed back in storage.
5. When in run mode (05 command issued), pressing the RE (reset) key twice or pressing any valid data or function key gives control to the control operator terminal, thus allowing the control operator to enter any of the debug commands.
6. Changes to storage containing the application programs and the configuration generation data using the 02, 10, and 12 commands will not be accepted when using an operational diskette; a 90086 error message will be displayed. All other debug commands are still valid.

With nonoperational diskettes, these storage changes are permitted, and a count of the number of changes made is kept. This count can be displayed, when not in debug mode, using the 047 command.

Refer to the debug error messages table following the debug commands for a description of error messages that occur only in debug mode. Refer to "Messages" for a description of any other displayed messages.



Debug Commands

| Command  | Meaning  |
|--|--|
| <p><b>00</b></p>   | <p>Leave the debug mode and return to the normal logon mode in which the control operator commands are valid. All stops will be removed and single-cycle mode and hard-copy trace will be turned off.</p>  |
| <p><b>01 SS(Z) (X)DDDDD</b></p> <p>SS = segment number (0–15). If 14, constant section of split AP will be displayed.</p> <p>SSZ = 140 for instruction section of split AP; if AP is not split, only SS = 14 is necessary.</p> <p>DDDDD = the displacement in decimal of the first byte to be displayed.</p> <p>XDDDD = the displacement in hexadecimal of the first byte to be displayed.</p>   | <p>Display (read) eight bytes of data from segment SS, beginning at the displacement specified by (X)DDDDD. After the first eight bytes have been displayed, the next eight bytes are displayed each time the EM (enter) key is pressed, up to the end of the segment.</p> <p>See the 09 command when requesting segment 0.</p>  |
| <p><b>02 SS(Z) (X)DDDDD DATA</b></p> <p>SS = segment number (0–15). If 14, constant section of split AP will be displayed.</p> <p>SSZ = 140 for instruction section of split AP; if AP is not split, only SS = 14 is necessary.</p> <p>DDDDD = the displacement in decimal of the first group of consecutive bytes in which DATA is to be stored.</p> <p>XDDDD = the displacement in hexadecimal of the first group of consecutive bytes in which DATA is to be stored.</p> <p>DATA = as many as eight bytes (16 characters) of hexadecimal data. If DATA is an odd number, the leftmost four bits will be set to 0. For example:</p> <p style="padding-left: 40px;"><b>02 14 X3CE 123</b></p> <p>will replace two bytes of data at X'3CE' with X'0123'.</p> | <p>Change the information (write) in as many as eight bytes of segment SS by replacing this information with DATA. If the DATA is accepted, eight bytes will be displayed, starting at displacement (X)DDDDD. After this display, pressing the EM (enter) key will display the next eight bytes just as if the 01 command had been entered.</p> <p>See the 09 command when requesting segment 0.</p> <p>If changes are made to an overlay section, the change is lost as soon as the next overlay is called in. See the 032 command.</p> <p>This command is valid only when using non-operational diskettes. If the change is accepted, the storage change count is incremented.</p> |

**Debug Commands (cont.)**

| Command  | Meaning   |
|--|---|
| <p><b>03 (X)DDDDD</b></p> <p>DDDDD = the byte address in decimal of an instruction in the application program of the work station being debugged.</p> <p>XDDDD = the byte address in hexadecimal of an instruction in the application program of the work station being debugged.</p> <p>The application program is stored in segment 14. As with any segment, the bytes are numbered consecutively, with the first byte being numbered 0.</p> | <p>At the byte address specified by (X)DDDDD, place a stop in the application program. Up to five stops can be placed in the program, with five different 03 commands. When the program reaches a stop address, it stops (does not do that instruction) and AT XXXX DATA is displayed, where XXXX is the hexadecimal byte address of the instruction and DATA is the six bytes beginning at the stop address. If the stop address is less than six bytes from the end of the application program, DATA will not be displayed. At this point, any of the debug commands can be entered. To start the work station again, enter a 05 command. The work station continues to run until another stop is found, the RE (reset) key is pressed twice, or any valid data or function key is pressed.</p> <p>The stop is in effect only for the work station being debugged and does not affect other work stations using the same application program.</p> <p>All stops are removed when a 00 command is issued.</p> |
| <p><b>04 (X)DDDDD</b></p> <p>DDDDD = the byte address in decimal at which a stop has been placed by a 03 command.</p> <p>XDDDD = the byte address in hexadecimal at which a stop has been placed by a 03 command.</p>  | <p>Remove the stop that has been placed at (X)DDDDD by a 03 command. If 04 0 is entered, all stops are removed.</p>   |
| <p><b>05 (X)DDDDD</b></p> <p>DDDDD = the byte address in decimal of an instruction in the application program of the work station being debugged.</p> <p>XDDDD = the byte address in hexadecimal of an instruction in the application program of the work station being debugged.</p>  | <p>This is the "go" command; start the work station being debugged if it was stopped. The work station will continue to run until another stop is encountered, the RE (reset) key is pressed twice, or any valid data or function key is pressed.</p> <p>If an address is specified with this command, the work station will begin execution at the specified address even if it is idle.</p>   |

Debug Commands (cont.)

| Command  | Meaning  |
|--|--|
| <p><b>06 XX</b><br/>           XX = one or two characters that identify any valid work station, not just the work station being debugged.</p> <p>The output format is:<br/>           LSDM</p> <p>L = loop number (1–6).<br/>           S = terminal address (0–15).<br/>           D = component address, as follows:</p> <ul style="list-style-type: none"> <li>1 = 3604 keyboard</li> <li>2 = 3604 display</li> <li>3 = magnetic stripe encoder</li> <li>4 = 3610 or 3612 document printer or 3618 printer</li> <li>5 = 3611 or 3612 passbook printer</li> <li>6 = 3606 or 3608 keyboard, display, and magnetic stripe reader</li> <li>7 = 3608 printer</li> <li>8 = 3614 terminal</li> </ul> <p>M = modulus value assigned at configuration generation time.</p> <p>If LSDM = FFFF, no component is assigned to the LDA.</p> | <p>Display information that identifies all the terminal components connected with logical work station XX. A work station may have as many as eight terminal components, each identified by a logical device address (0–7). The display consists of eight entries, corresponding to LDAs 0–7, in the form of four hexadecimal characters, LSDM.</p>  |
| <p><b>07 SS</b><br/>           SS = any segment number (0–15) that is valid for the work station being debugged.</p>   | <p>Display the header of segment SS. The header is displayed in hexadecimal and gives the following information in this order: segment length, field pointer, field length, and secondary field pointer.</p> <p>For segment 0, the header for operator A or B is displayed based upon the last 09 command. If no 09 command was issued, then the A-operator segment 0 header is displayed.</p> |
| <p><b>08</b></p>   | <p>Immediately stop the work station being debugged. That is, stop the application program at its current instruction. No further instructions will be performed until an 05 command is given.</p>   |

**Debug Commands (cont.)**

| Command  | Meaning  |
|--|--|
| <p><b>09 X</b><br/>                     X = 0 (or not 1) for A operator or 1 for B operator.</p>   | <p>If the work station being debugged has an A operator and a B operator, this command must be given before displaying or changing segment 0 of operator B. Unless a 09 command is given, any command to display or change segment 0 is assumed to be for operator A.</p>  |
| <p><b>10 SS C (X)DDDDD</b><br/>                     SS = any segment number (0-15) that is valid for the work station being debugged.<br/>                     C = code for field to be changed:<br/>                         1 = primary field pointer<br/>                         2 = field length<br/>                         3 = secondary field pointer<br/>                     DDDDD = the value in decimal to replace the field specified by C.<br/>                     XDDDD = the value in hexadecimal to replace the field specified by C.</p> | <p>Change the primary field pointer, field length, or secondary field pointer in the specified segment header.</p> <p>If the change is accepted, the full header will be displayed; see 07 command.</p> <p>For segment 0, the header for operator A or B is changed based on the last 09 command. If no 09 command was issued, then the A-operator segment 0 header is changed.</p> <p>Many application program instructions depend on the header information being valid, so be careful when using this command.</p> <p>This command is valid only when using nonoperational diskettes. If the change is accepted, the storage change count is incremented.</p> |
| <p><b>11 V (X)AAAAA</b><br/>                     V = 0 to specify control storage; 1 or 2 to specify user storage.<br/>                     AAAAA is the byte address in decimal, within the specified storage, of the first byte to be displayed.<br/>                     XAAAA is the byte address in hexadecimal, within the specified storage, of the first byte to be displayed.</p>   | <p>Display eight bytes of data beginning at byte address (X)AAAAA in the storage specified by V. This command works the same as command 01, except that you are now directly addressing a byte within control or user storage rather than addressing a byte within a segment of the storage connected with a work station.</p>   |

Debug Commands (cont.)

|   |   |
|---|---|
| <p><b>12 V (X)AAAAA DATA</b><br/>V = 1 or 2 to specify user storage; 0 is not valid.<br/>AAAAA is the byte address in decimal, within the user storage, of the first byte to be changed.<br/>XAAAA is the byte address in hexadecimal, within the user storage, of the first byte to be changed.<br/>DATA = as many as eight bytes (16 hexadecimal characters) that are to replace the original data.</p> | <p>Change as many as eight bytes of data beginning at byte address (X)AAAAA in the user storage.</p> <p>This command can be used to change information in the configuration generation data* or customer's application programs in user storage. No change can be made to control storage or to the section of user storage used by the system monitor. Care should be used when changing configuration data because an incorrect address or data may cause a system error and require a reload.</p> <p>This command works the same as command 02, except that you are now directly addressing a byte within user storage rather than addressing a byte within a segment of the storage connected with a work station.</p> <p>This command is valid only when using nonoperational diskettes. If the change is accepted, the storage change count is incremented.</p> |
|---|---|

\*The address for this data can be obtained from the configuration generation listing.

Debug Commands (cont.)

| Command   | Meaning  |
|---|--|
| <p><b>13 X</b><br/>                     X = Any character to request a hard copy trace of all instruction addresses executed.</p> | <p><b>13 - Single-cycle mode.</b> Enter the 05 command to start cycling the work station being debugged. (This command gives a function similar to the single-cycle switch on a central processor.) Thereafter, each time the EM (enter) key is pressed, the next instruction of the application program for the work station being debugged is performed. At the "control operator 3604", the message AT XXXX DATA is displayed after each cycle, where XXXX is the hexadecimal address of the program instruction to be performed next and DATA is the six bytes beginning at that address. If the XXXX address is less than six bytes from the end of the application program, DATA will not be displayed. Each time this message is displayed, other debug commands can be entered, if desired, before performing the next program instruction. If another debug command is entered, a 05 command must then be entered to cause the next instruction to be performed.</p> <p><b>13 X - Hard copy trace.</b> Enter the 05 command to start cycling the work station being debugged. The operation is the same as for the single-cycle mode above except that the AT XXXX DATA message is printed on the assigned output printer and the operation is continuous; that is, the EM (enter) key does not have to be pressed for each address printed. To temporarily stop the trace, press the RE (reset) key twice. If a printer error occurs, a 90007 message will be displayed and the single-cycle mode is entered. To restart the trace, issue the 13 X command followed by the 05 command. If the RE (reset) key was used to stop the trace, only the 05 command is needed to restart the trace.</p> <p>An output printer must have been assigned (by means of a 005 or 006 command) before entering the debug mode (123 command) if a hard copy trace is required.</p> <p>If stops have been placed in the application program, they are ignored while in single-cycle mode or hard copy trace.</p> |

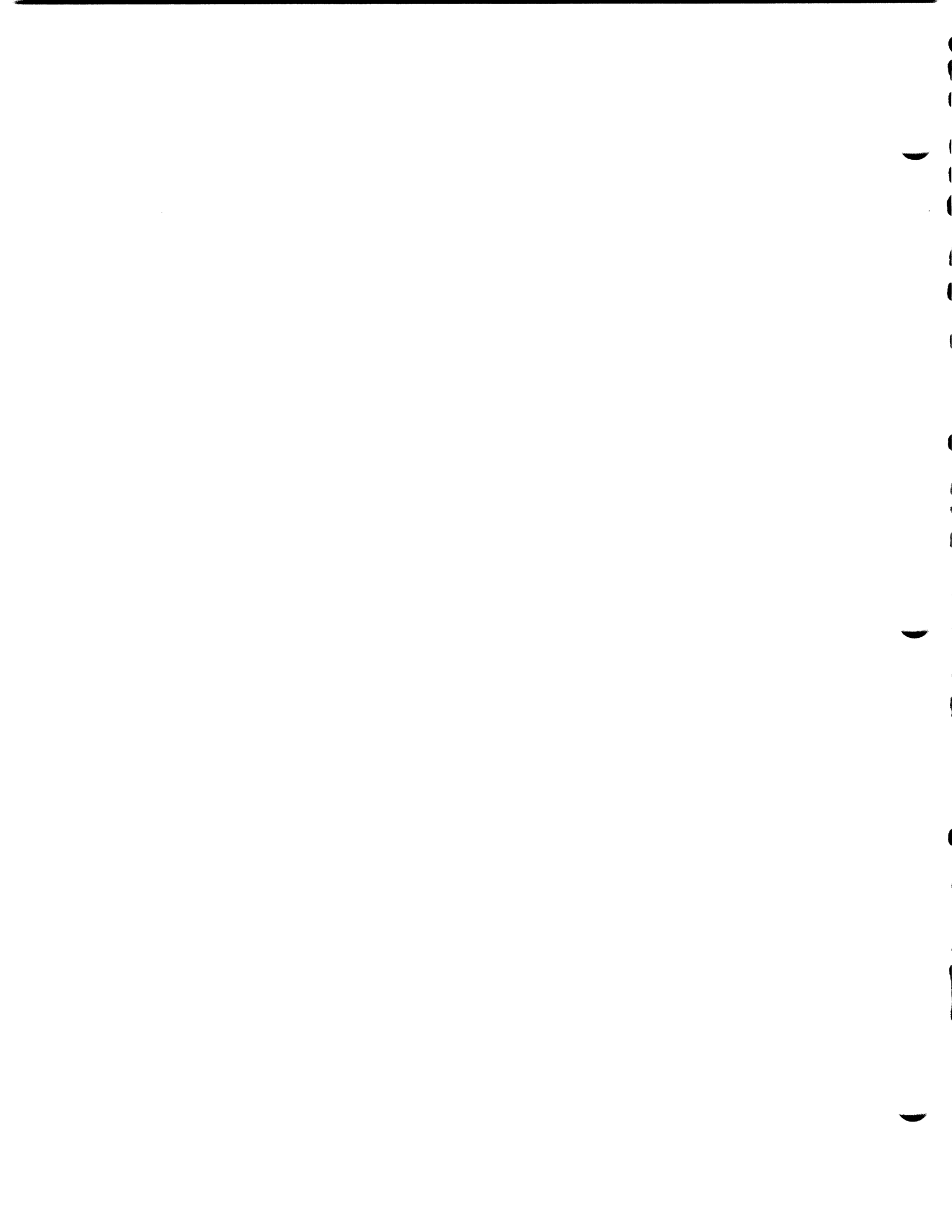


Debug Commands (cont.)

| Command   | Meaning  |
|---|--|
| <p><b>14</b></p>  | <p>Leave the single-cycle mode and turn off the hard-copy trace. This command allows the work station being debugged to start performing again without stopping or tracing after each instruction.</p> |
| <p><b>15 SS</b></p> <p>SS = segment number (0 – 15). Optional; if omitted, indexing is checked for the station only.</p> <p>The output format is:</p> <p>FF AABB CCDD</p> <p>FF = flag byte:</p> <ul style="list-style-type: none"> <li>X'80' = segment level request (that is, that SS was specified)</li> <li>X'02' = station is active for indexing</li> <li>X'01' = segment is active for indexing</li> </ul> <p>AA = number of station being tested for indexing.</p> <p>BB = for station level request is FF if the station is not active for indexing; or is the number of the segment that contains the station's Index Register Number Table, if the station is active for indexing.</p> <p>for segment level request is the number of the segment being tested (the SS operand of the command).</p> <p>CCDD = for station level request is FFFF if the station is not active for indexing; or is the displacement to the beginning of the Index Register Number Table from the beginning of segment BB, if the station is active for indexing.</p> <p>for segment level request is FFFF if the station is not active for indexing; otherwise CC is the index register number for operand 1 type fixed-field operands that refer to segment BB, and DD is the index register number for operand 2.</p> <p>Optional module ID 68 is required.</p> | <p>Test indexing status for the work station being debugged or a segment (SS) of the work station.</p>   |

### Debug Error Messages

| Message | Meaning  | Action   |
|---------|--|--|
| 90080   | Operator keyboard error. An invalid debug keyboard command was entered or one of the input fields was not valid.   | Enter the command again with the correct information.  |
| 90081   | An error was detected while writing to the display.  | Enter the command again. If the error persists, log off and try another 3604.  |
| 90082   | One of the following: <ul style="list-style-type: none"> <li>● The operator keyed an invalid segment number or an invalid address of the first byte to be displayed or changed.</li> <li>● The end of the segment was reached during a segment display.</li> </ul> | Enter the command again with the correct information.  |
| 90084   | One of the following: <ul style="list-style-type: none"> <li>● The stop table was full at the time of a 03 command.</li> <li>● An invalid address was keyed on a 04 command.</li> <li>● An invalid direct address was keyed on an 11 or 12 command.</li> </ul>     | Enter the command again with the correct information. If there is an error on the 03 command, the stop table is full. You must remove a stop with a 04 command before the next 03 command can be accepted. |
| 90086   | An attempt was made to change the storage containing application programs and the configuration data when using an operational diskette.   | These changes can be made only at the host and a new diskette created, or use a non-operational diskette.  |
| 90088   | One of the following: <ul style="list-style-type: none"> <li>● An invalid work station identification was entered on a 06 command.</li> <li>● There is no A/B operator on the work station being debugged.</li> </ul>  | Enter the command again with the correct information, if a 06 command. If there is no B operator, issue a 09 command for an A operator, then try the previous command again.                               |

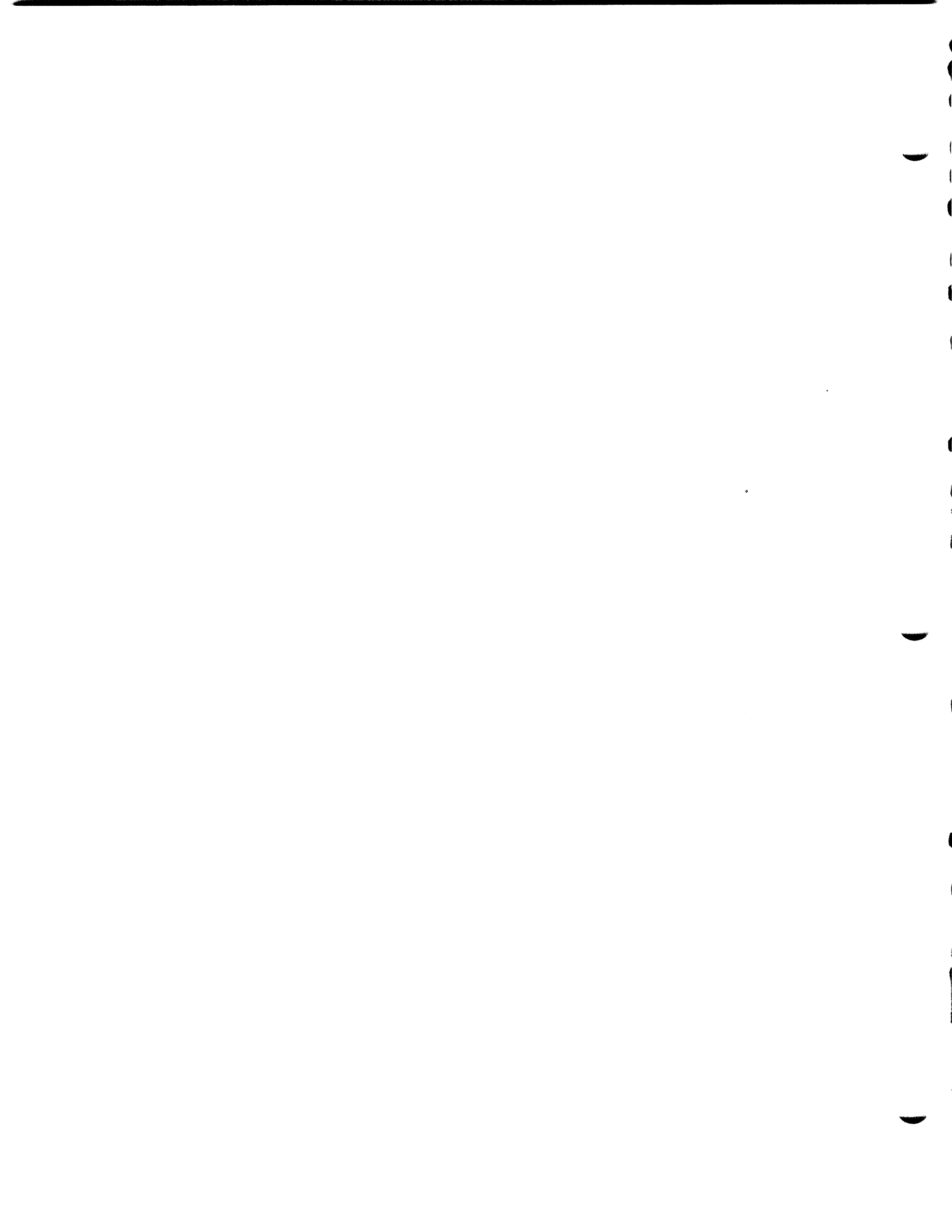


## Contents – Disk File Error Recovery Procedures

Moving the System Track  
Clearing the Initial Tracks  
Locate Flagged Sector(s) and Assign Alternative Sectors  
Reformatting Sectors  
Surface Analysis

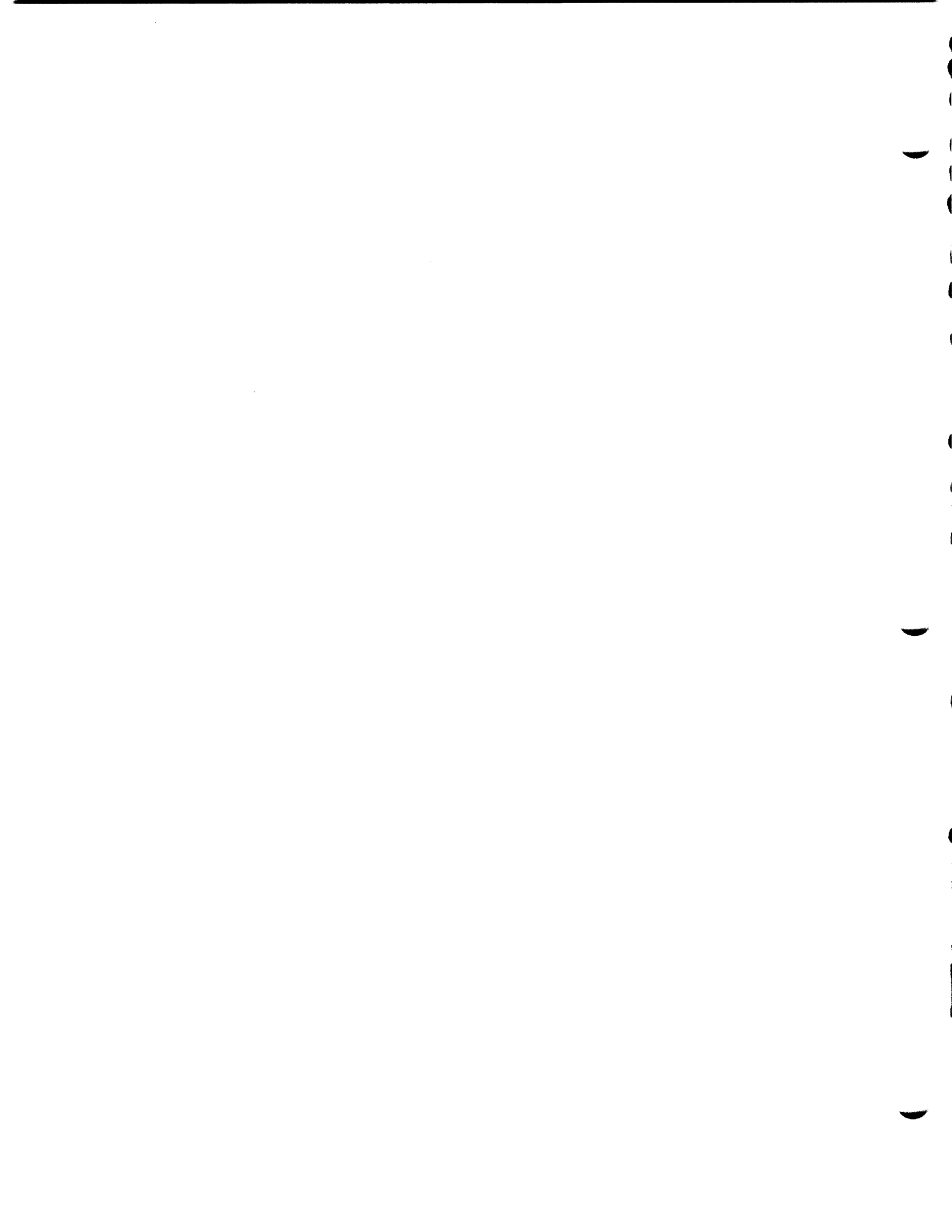
DISK FILE ERROR RECOVERY PROCEDURES

This page precedes the System Operating Procedures, Moving the System Track keying page.



This page precedes the System Operating Procedures, Moving the System Track page 1.





## **MOVING THE SYSTEM TRACK**

This procedure allows you to move the location of the system track for the disk file to another track location. This procedure requires a 3602 operational diskette.

**1. Log on at an idle 3604.**

See the logon procedure under "General Operating Procedures."

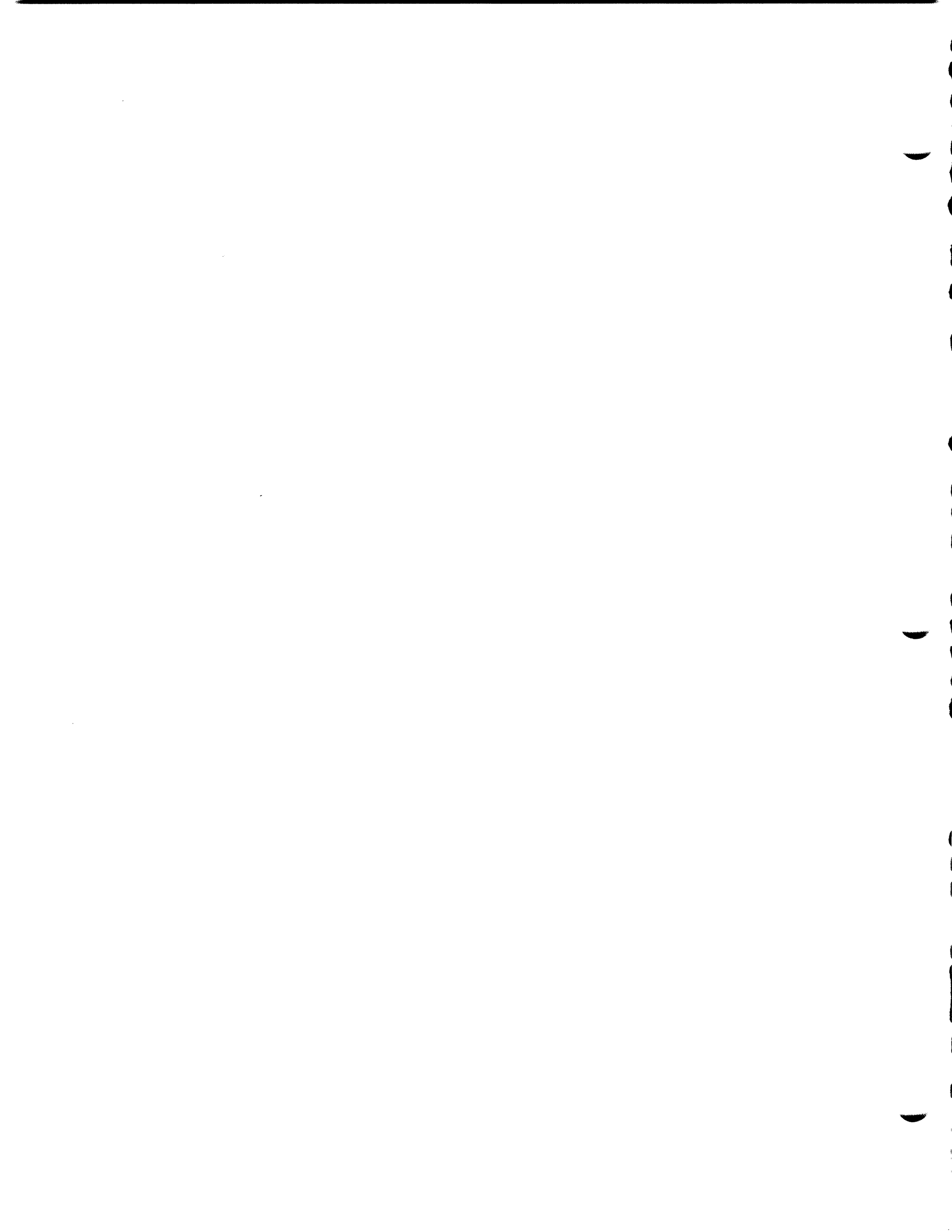
**2. Key and enter 094 XXX F.**

XXX = the new physical track number in decimal.

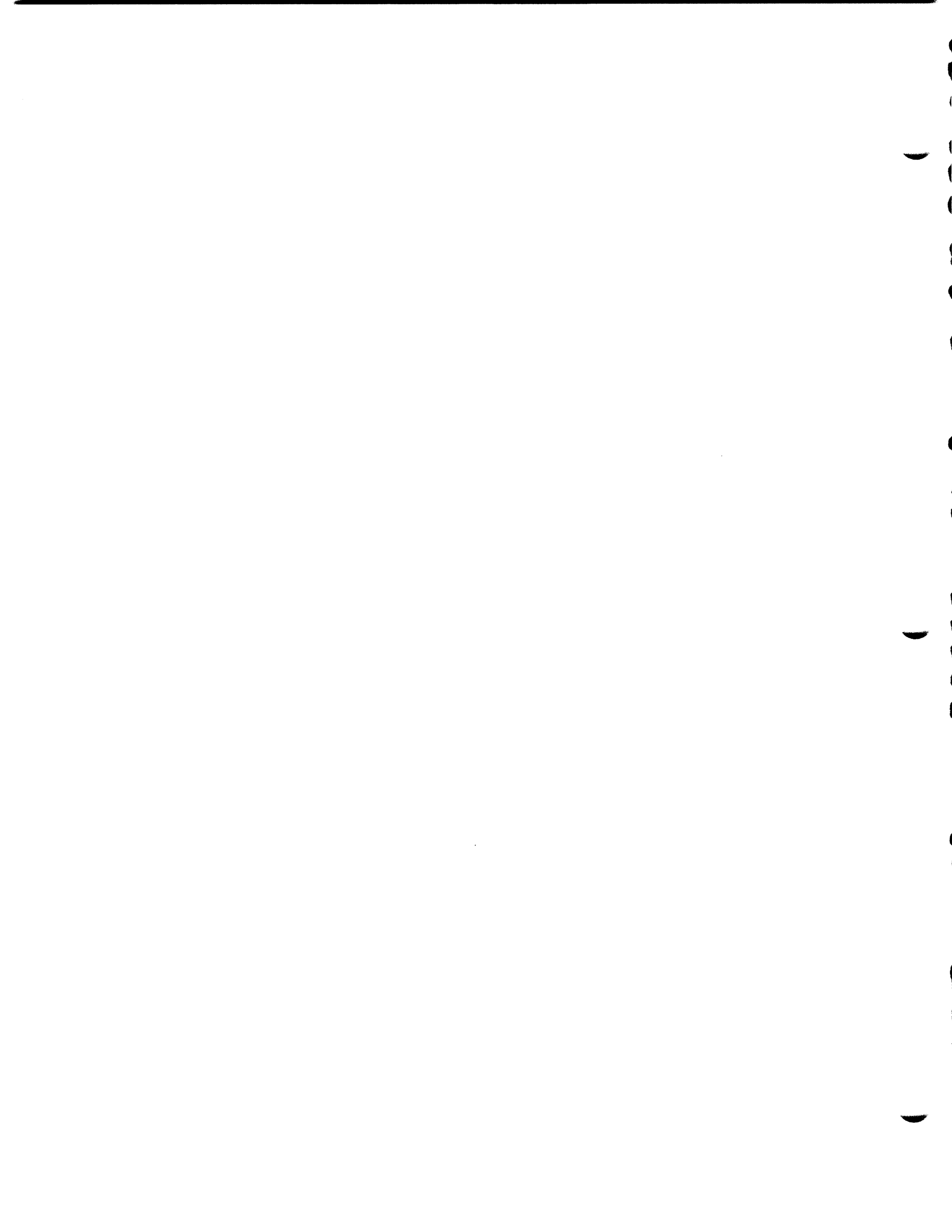
F = 0 for moveable-head; not 0 for fixed-head request.

**3. If the cursor is displayed, but no messages, the move was successful; other system monitor commands can be entered.**

Refer to the 094 command for the possible prompt messages and the appropriate replies.



This page precedes the System Operating Procedures, Clearing the Initial Tracks page 1.



## **CLEARING THE INITIAL TRACKS**

This facility clears to zeros the relocate tracks and track 0 and then assigns track 0 as the system track. This facility is used only if the entire disk file is reformatted afterward. Use the special disk file facilities diskette (IBM PN 4944351 at EC 745504 or later).

The facility may be stopped by pressing the FR (free) key on the 3604; do not press the controller RESET switch.

To be sure the disk file logic is operating properly, you may wish to run the problem identification facility ('1010') first; see the Local Location Problem Recovery procedures in this operating guide.

The tables below list the prompt and error messages and the actions required on your part during the execution of this facility.

1. **Ensure that power is on at the 3604 at address 1 of loop 1.**
2. **Insert the disk file facilities diskette and press the controller RESET switch.**
3. **Wait for the BCB0 message and cursor to be displayed.**
4. **Key and enter the 3604 model number (1, 2, 3, 4, 5, or 6).**

The model number is found on the power rating plate.
5. **Wait for the BC80 message and cursor to be displayed.**
6. **Key and enter 000001.**

00F0 is displayed after successful message entry.
7. **Wait for the 0012 message.**
8. **Key and enter C to cancel or F to execute this facility.**
9. **Wait for the 0014 message, which indicates that this facility is completed.**
10. **To restore the disk file to operational status, execute option 'C6' of the Reformatting Sectors facility next; enter C and go to step 6 of that facility.**



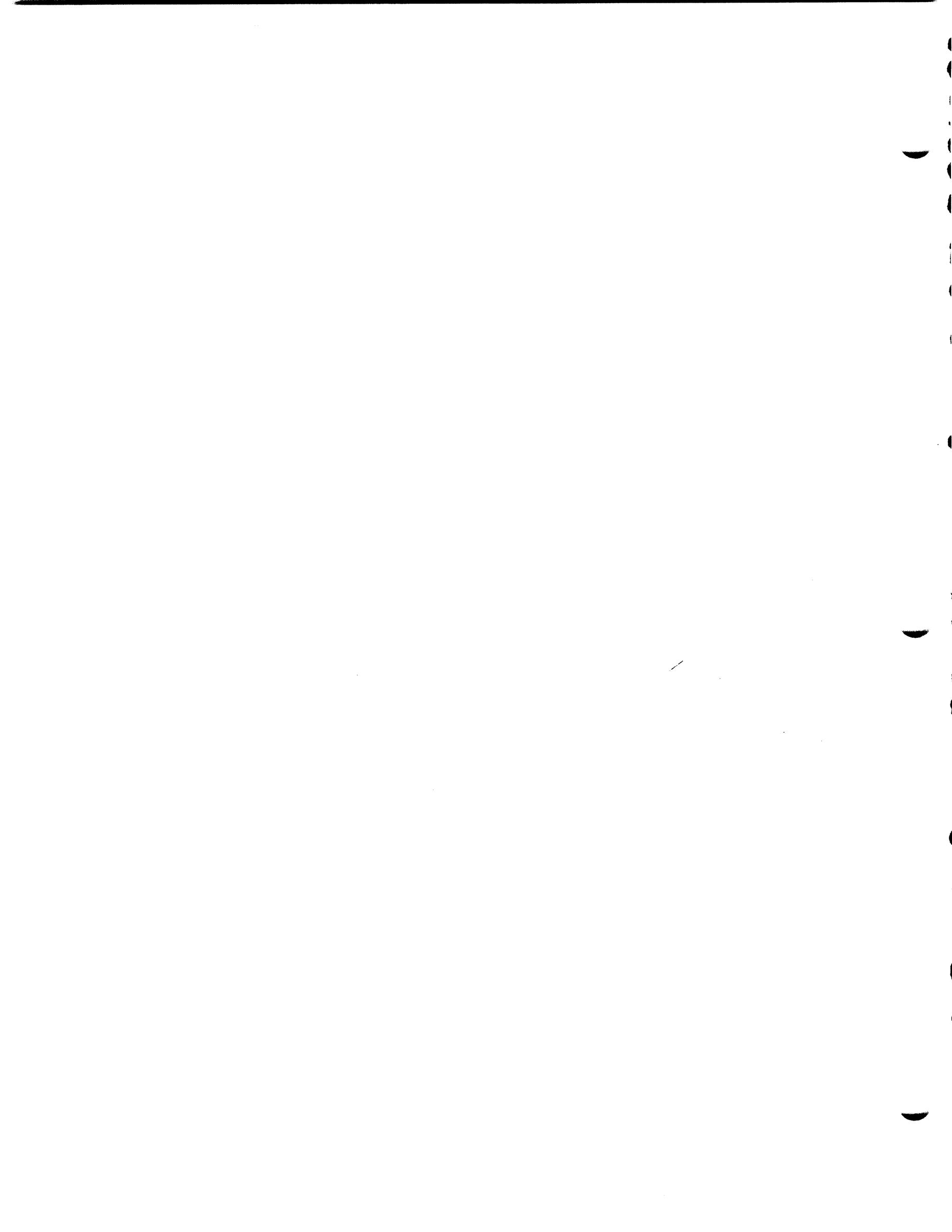
### Clearing the Initial Tracks Prompt Messages

| Message | Meaning  | Action   |
|---------|--|--|
| 0000    | Facility is terminated; same as the BC80 message.  | Go to step 6 of the next facility you wish to execute, or reload the system.             |
| 0012    | This message is a request to indicate: end (without initialization) or continue execution. | Enter C to end or F to continue this facility.   |
| 0014    | Facility is completed.   | Enter C, go to step 6 of the Reformatting Sectors facility, and execute the 'C6' option. |
| BC80    | This message is a request to identify the facility to be executed.                         | Go to step 6 of the next facility you wish to execute.                                   |
| BCB0    | This message is a request to identify the 3604 model number.                               | Enter 3604 model number.   |

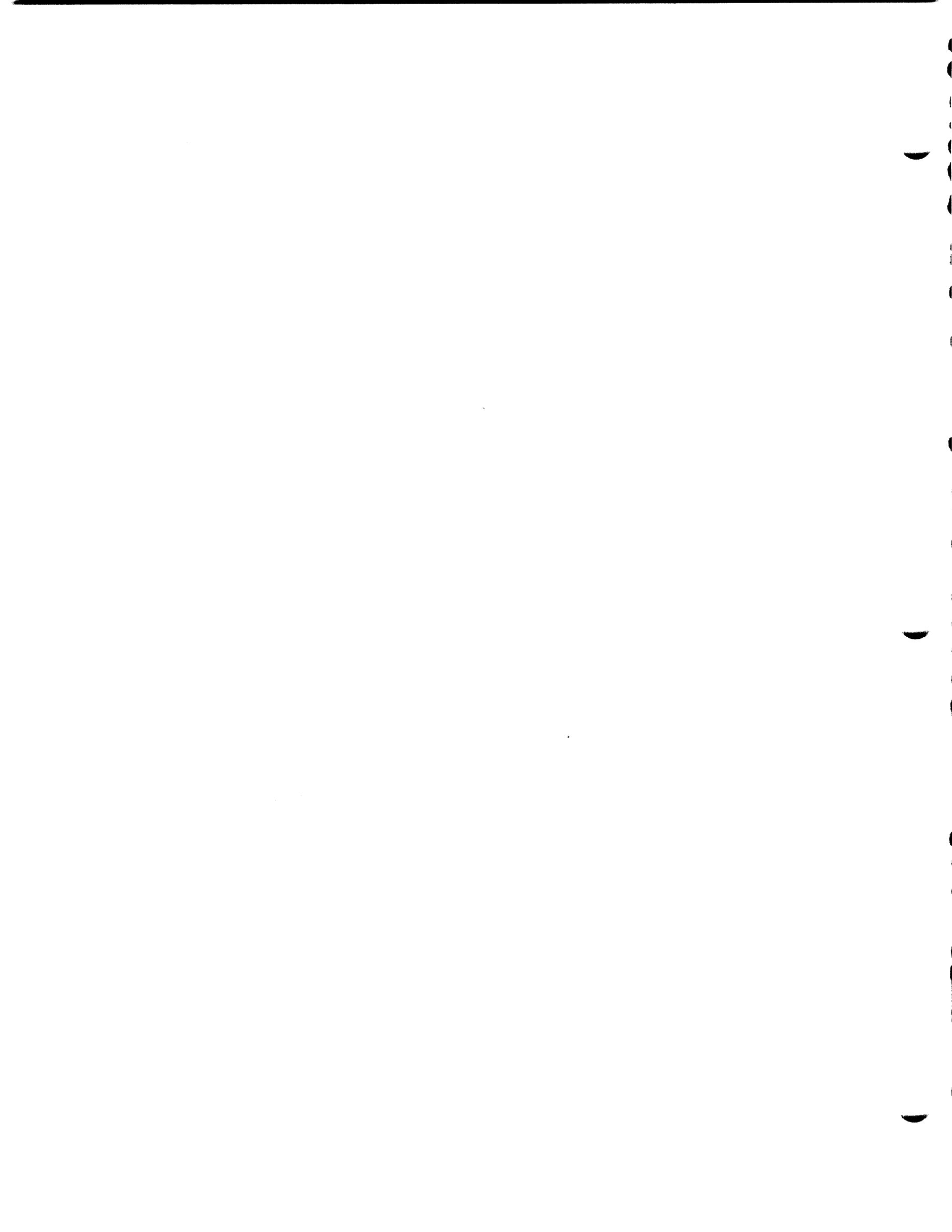
### Clearing the Initial Tracks Error Messages

| Message         | Meaning   | Action   |
|-----------------|---|--|
| 0181            | Unable to read the disk file label record.  | Press the FR (free) key to end, then retry this facility.* |
| 0182<br>D. . .D | Unable to initialize the disk file.<br><br>D. . .D = data for service representative use. | Enter C to retry this facility.*                           |
| 0183            | Unable to access the diskette for facility information.                                   | Press the FR (free) key to end, then retry this facility.* |
| 0184            | The system cannot access the disk file.   | Press the FR (free) key to end, then retry this facility.* |

\*If, after several retries, the error message continues to be displayed, contact your service representative. You may then wish to start saving critical data sets, because it may be necessary to clear the disk file to zeros.



This page precedes the System Operating Procedures, Locate Flagged Sector(s) page 1.



## **LOCATE FLAGGED SECTOR(S) AND ASSIGN ALTERNATIVE SECTORS**

This facility reads the sector IDs, looking for those that are flagged as failing, and attempts to assign an alternative sector for each failing sector. Some portion of the data stored on the disk file may be affected or lost when using this facility. Use the special disk file facilities diskette (IBM PN 4944351 at EC 745504 or later).

The facility may be stopped by pressing the FR (free) key on the 3604; do not press the controller RESET switch.

To be sure the disk file logic is operating properly, you may wish to run the problem identification facility ('1010') first; see the Local Location Problem Recovery procedures in this operating guide.

The tables below list the prompt and error messages and the actions required on your part during the execution of this facility.

- 1. Ensure that power is on at the 3604 at address 1 of loop 1.**
- 2. Insert the disk file facilities diskette and press the controller RESET switch.**
- 3. Wait for the BCB0 message and cursor to be displayed.**
- 4. Key and enter the 3604 model number (1, 2, 3, 4, 5, or 6).**

The model number is found on the power rating plate.

- 5. Wait for the BC80 message and cursor to be displayed.**
- 6. Key and enter 000003.**

00F0 is displayed after successful message entry.

- 7. Wait for the 0034 message or one of the prompting or error messages (see following tables).**
- 8. This facility is completed when the 0034 message is displayed; if you wish to run another disk file error recovery facility that uses the disk file facilities diskette, enter C and go to step 6 of the facility you wish to run. If you wish to restore normal operations, enter C and then reload the system.**



**Locate Flagged Sector(s) and Assign Alternative Sectors Prompt Messages**

| Message                 | Meaning   | Action   |
|-------------------------|---|--|
| 0000                    | Facility is terminated; same as the BC80 message.   | Go to step 6 of the next facility you wish to execute, or reload the system.   |
| 0031<br>IDID<br>D. . .D | Writing an ID or a displaced ID in sector IDID is not possible.<br><br>D. . .D = data for service representative use. | Press EM (enter) key only to retry this sector; or enter C to abandon this sector and then contact your service representative.* |
| 0034<br>XXXX            | Facility summary count.<br><br>XXXX = the count, in decimal, of the number of flagged sectors.                        | Enter C to continue.   |
| BC80                    | This message is a request to identify the facility to be executed.  | Go to step 6 of the next facility you wish to execute.   |
| BCB0                    | This message is a request to identify the 3604 model number.  | Enter 3604 model number.   |

\*You may then wish to start saving critical data sets, because it may be necessary to clear the disk file to zeros.

Locate Flagged Sector(s) and Assign Alternative Sectors Error Messages

| Message                                       | Meaning   | Action   |
|---|---|--|
| 0381  | Unable to read the disk file label record.  | Press the FR (free) key to end, then retry this facility.*   |
| 0382<br>D...D                                 | Unable to initialize the disk file.<br><br>D...D = data for service representative use.   | Enter C to retry this facility.*   |
| 0383  | Unable to access the diskette for facility information.   | Press the FR (free) key to end, then retry this facility.*   |
| 0384  | The system cannot access the disk file.   | Press the FR (free) key to end, then retry this facility.*   |
| 0385  | Unable to assign an alternative sector.   | Enter C to go to the next sector.<br>Contact your service representative.**  |
| 0386  | Unable to assign an alternative sector;<br>the relocate tracks are full.  | Enter C to go to the next sector<br>without an alternative sector being<br>assigned. Contact your service<br>representative.** |
| 0387  | Unable to restore the disk file label record.   | Contact your service representative.**   |
| 038A<br>IDID<br>D...D                         | Unable to read an ID or displaced ID in sector<br>IDID; no alternative has been assigned.<br><br>D...D = data for service representative use.   | Enter C to try to reformat the<br>sector.  |
| 038B  | Unable to find the correct track (seek error).  | Enter C to retry; or enter F to end<br>this facility and then contact your<br>service representative.**                        |
| 038C<br>IDID<br>XXYY<br>XXYY<br>.....<br>XXYY | If processing of the track identified in IDID<br>resulted in any of the track's sectors being re-<br>formatted, the facility will verify the read-<br>ability of the track by reading all of that track's<br>sector IDs. If any sector IDs are found bad<br>during the verification, this message is displayed.<br>IDID is the address of the last reformatted<br>sector of this track. Each XXYY addresses a<br>sector whose ID was found to be bad during the<br>verification (track reread) operation. | Enter C to continue; or enter F to end<br>this facility and then contact your<br>service representative.**                     |

\* }  
\*\* } (See notes on next page.)

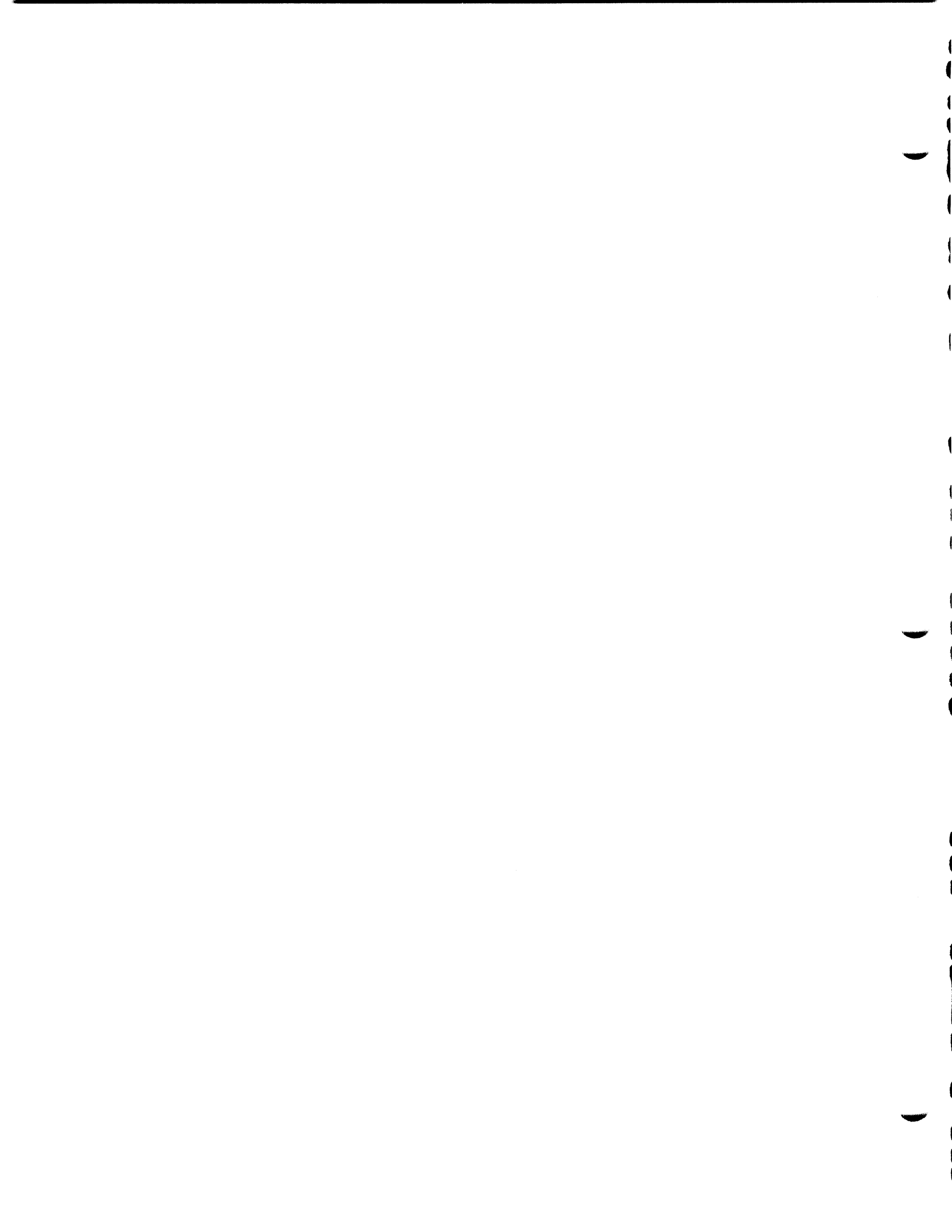
Locate Flagged Sector(s) and Assign Alternative Sectors Error Messages (cont.)

| Message      | Meaning  | Action  |
|--------------|--|---|
| 038D<br>IDID | This facility was unable to verify that the read/write head is positioned over the correct track before rewriting a sector ID. Verification is by attempting to read a sector ID containing the expected track number. If this is not possible with any of the 60 sectors, then the head position is not verified. | Enter F to retry the verification, C to go to the next track, E to force writing the sector's ID (use only at the direction of your service representative), or the FR (free) key only to end this facility. If C or the FR (free) is entered, contact your service representative.** |

\*If, after several retries, the error message continues to be displayed, contact your service representative. You may then wish to start saving critical data sets, because it may be necessary to clear the disk file to zeros.

\*\*You may then wish to start saving critical data sets, because it may be necessary to clear the disk file to zeros.

This page precedes the System Operating Procedures, Reformatting Sectors page 1.



## REFORMATTING SECTORS

This facility reformats all the disk file sectors, a single sector, or only the fixed-head area, according to the options entered. Some portion of the data stored on the disk file may be affected or lost when using this facility. Use the special disk file facilities diskette (IBM PN 4944351 at EC 745504 or later).

The facility may be stopped by pressing the FR (free) key on the 3604; do not press the controller RESET switch.

To be sure the disk file logic is operating properly, you may wish to run the problem identification facility ('1010') first; see the Local Location Problem Recovery procedures in this operating guide.

The tables below list the prompt and error messages and the actions required on your part during the execution of this facility.

1. Ensure that power is on at the 3604 at address 1 of loop 1.
2. Insert the disk file facilities diskette and press the controller RESET switch.
3. Wait for the BCB0 message and cursor to be displayed.
4. Key and enter the 3604 model number (1, 2, 3, 4, 5, or 6).

The model number is found on the power rating plate.

5. Wait for the BC80 message and cursor to be displayed.
6. Key and enter 000004.

00F0 is displayed after successful message entry.

7. Wait for the 0045 message.
8. Key and enter CX, FXIDID, or A0IDID.

See 0045 message in the following table for option meanings.

9. If formatting single sectors (option F or A in step 8), wait for the 0045 message and repeat step 8 or, to end the facility, press the FR (free) key. If formatting the entire disk file (option C), wait for the 0044 message.
10. This facility is completed when the 0044 message is displayed; if you wish to run another disk file error recovery facility that uses the disk file facilities diskette, enter C and go to step 6 of the facility you wish to run. If you wish to restore normal operations, enter C and then reload the system.



Reformatting Sectors Prompt Messages

| Message                 | Meaning   | Action   |
|-------------------------|---|--|
| 0000                    | Facility is terminated; same as the BC80 message.   | Go to step 6 of the next facility you wish to execute, or reload the system.   |
| 0041<br>IDID<br>D. . .D | Writing an ID or a displaced ID in sector IDID is not possible.<br><br>D. . .D = data for service representative use. | Press EM (enter) key only to retry; or enter C to abandon this sector and then contact your service representative.*   |
| 0044<br>XXXX            | Facility summary count.<br><br>XXXX = the count, in decimal, of the number of flagged sectors.                        | Enter C to continue.   |
| 0045                    | This message is a request to enter the facility options, in hexadecimal.  | Enter CX, FXIDID, or A0IDID.<br>C = format the entire disk file.<br>F = format only the single sector at physical address IDID.<br>A = unconditionally assign an alternative sector for the sector at physical address IDID, even if it is good.<br>X = one of the following:<br>'1' to format only unreadable sector IDs and write zeros in the data field.<br>'2' to format each sector with good IDs.**<br>'4' to write zeros in the data field of each sector being formatted.<br>'8' to format only the fixed-head area; not used if a single sector option is selected.<br>'5', '6', '9', 'A', 'C', 'D', or<br>'E' to identify a combination of options. |

\*(See note on next page.)

Reformatting Sectors Prompt Messages (cont.)

| Message                 | Meaning  | Action   |
|-------------------------|--|--|
| 0046<br>IDID<br>D. . .D | <p style="text-align: center;"><i>If CX or FXIDID was used:</i></p> <p>Writing the data field in sector IDID is not possible.</p> <p>D. . .D = data for service representative use.</p> <p style="text-align: center;"><i>If AOIDID was used:</i></p> <p>An alternative sector cannot be assigned for sector IDID.</p> <p>D. . .D = data for service representative use.</p> | <p>Press EM (enter) key only to retry writing data in this sector; if this message appears again with the same IDID, enter C to attempt to assign an alternative sector.</p> <p>Enter C to retry; or enter F to end this AOIDID request and then contact your service representative.*</p> |
| BC80                    | This message is a request to identify the facility to be executed.   | Go to step 6 of the next facility you wish to execute.   |
| BCB0                    | This message is a request to identify the 3604 model number.   | Enter 3604 model number.   |

\*You may then wish to start saving critical data sets, because it may be necessary to clear the disk file to zeros.

\*\*The data field is not affected. If an alternative sector had been previously assigned to a reformatted sector, the user data in the alternative sector can no longer be referred to after this sector is reformatted; it is effectively lost data.

Reformatting Sectors Error Messages

| Message                                      | Meaning   | Action   |
|--|---|--|
| 0481   | Unable to read the disk file label record.  | Press the FR (free) key to end, then retry this facility.*   |
| 0482<br>D . . D                              | Unable to initialize the disk file.<br>D . . D = data for service representative use.   | Enter C to retry this facility.*   |
| 0483   | Unable to access the diskette for facility information.   | Press the FR (free) key to end, then retry this facility.*   |
| 0484   | The system cannot access the disk file.   | Press the FR (free) key to end, then retry this facility.*   |
| 0485   | Unable to assign an alternative sector.   | Enter C to go to the next sector.<br>Contact your service representative.**  |
| 0486   | Unable to assign an alternative sector; the relocate tracks are full.   | Enter C to continue with this sector flagged bad and without an alternative sector being assigned.<br>Contact your service representative.**   |
| 0487   | Unable to restore the disk file label record.   | Contact your service representative.**   |
| 048B   | Unable to find the correct track (seek error).  | Enter C to retry; or enter F to end this facility and then contact your service representative.**  |
| 048C<br>IDID<br>XXYY<br>XXYY<br>....<br>XXYY | <p style="text-align: center;"><i>If FXIDID or A0IDID was used:</i></p> <p>This sector, IDID, has been successfully formatted; the IDs of sector(s) XXYY (in IDID format) of this same track could not be read.</p> <p style="text-align: center;"><i>(continued on next page.)</i></p> | <p>Reformat sector(s) XXYY by entering C to display the 0045 message. After formatting each XXYY sector in the track, the number of XXYYs displayed with this message should be reduced by 1; if not, contact your service representative.** Also, if the entire disk file surface had been analyzed with the Surface Analysis facility, and any unexpected XXYY sectors are displayed, contact your service representative.**</p> |

\* }  
\*\* } (See notes on next page.)

Reformatting Sectors Error Messages (cont.)

| Message         | Meaning   | Action   |
|-----------------|---|--|
| 048C<br>(cont.) | <p style="text-align: center;"><i>If CX was used:</i></p> <p>If processing of the track identified in IDID resulted in any of the track's sectors being reformatted, the facility will verify the readability of the track by reading all of that track's sector IDs. If any sector IDs are found bad during the verification, this message is displayed. IDID is the address of the last reformatted sector of this track. Each XXYY addresses a sector whose ID is bad.</p> | <p>Enter C to continue; or enter F to end this facility and then contact your service representative.**</p>  |
| 048D<br>IDID    | <p>This facility was unable to verify that the read/write head is positioned over the correct track before rewriting a sector ID. Verification is by attempting to read a sector ID containing the expected track number. If this is not possible with any of the 60 sectors, then the head position is not verified.</p>   | <p>Enter F to retry the verification, C to continue or to display the 0045 message if in single-sector mode (option F), E to force writing the sector's ID (use only at the direction of your service representative), or the FR (free) key only to end this facility.</p> |

\*If, after several retries, the error message continues to be displayed, contact your service representative. You may then wish to start saving critical data sets, because it may be necessary to clear the disk file to zeros.

\*\*You may then wish to start saving critical data sets, because it may be necessary to clear the disk file to zeros.

1

2

3

This page precedes the System Operating Procedures, Surface Analysis page 1.



1

1

1

## **SURFACE ANALYSIS**

This facility analyzes the entire disk file, a single sector, or only the fixed-head area for surface defects, according to the options entered. Some portion of the data stored on the disk file may be affected or lost when using this facility. Use the special disk file facilities diskette (IBM PN 4944351 at EC 745504 or later).

The facility may be stopped by pressing the FR (free) key on the 3604; do not press the controller RESET switch.

To be sure the disk file logic is operating properly, you may wish to run the problem identification facility ('1010') first; see the Local Location Problem Recovery procedures in this operating guide.

The tables below list the prompt and error messages and the actions required on your part during the execution of this facility.

- 1. Ensure that power is on at the 3604 at address 1 of loop 1.**
- 2. Insert the disk file facilities diskette and press the controller RESET switch.**
- 3. Wait for the BC80 message and cursor to be displayed.**
- 4. Key and enter the 3604 model number (1, 2, 3, 4, 5, or 6).**

The model number is found on the power rating plate.

- 5. Wait for the BC80 message and cursor to be displayed.**
- 6. Key and enter 000005.**

00F0 is displayed after successful message entry.

- 7. Wait for the 0055 message.**
- 8. Key and enter F71DID.**

F71DID analyzes the sector at physical address IDID. To identify all of the failing sectors, enter C7 in lieu of F71DID. (See 0055 message for definition of X = 7.)

- 9. Wait for and note each 0051, 0052, and/or 0053 message with its associated data or the 0054 or 0055 message.**
- 10. After noting each message and its associated data, enter C to continue. Repeat steps 9 and 10 until the 0054 message is displayed, then go to step 11. If the 0055 message is displayed, return to step 8 or press the FR (free) key to end.**

This information will be necessary if you are to run the Reformatting Sectors facility.

11. This facility is completed when the 0054 message is displayed; if you wish to run another disk file error recovery facility that uses the disk file facilities diskette, enter C and go to step 6 of the facility you wish to run. If you wish to restore normal operations, enter C and then reload the system.

Surface Analysis Prompt Messages

| Message                      | Meaning   | Action  |
|------------------------------|---|---|
| 0000                         | Facility is terminated; same as the BC80 message.   | Go to step 6 of the next facility you wish to execute, or reload the system.  |
| 0051<br>IDID<br>AAAA<br>BBCC | <p>The data field of sector IDID has been flagged as failing, and a stop on flagged sector has been requested.</p> <p>AAAA = alternative sector physical address (0000 if none assigned).</p> <p>BB = sector flag byte:<br/>Bits<br/>0-5 not used.<br/>6 failing sector.<br/>7 alternative sector already assigned.</p> <p>CC = meaningless data.</p> | Enter C to continue; if an alternative sector has not been assigned, use the Reformatting Sectors facility to assign an alternative sector.   |
| 0052<br>IDID                 | The ID field of sector IDID cannot be read, and a stop on unreadable sector IDs has been requested.   | Press EM (enter) key only to retry this sector, or enter C to abandon this sector. Entering C implies that this sector should subsequently be reformatted using the Reformatting Sectors facility (suggest X = 6 response to the 0045 message). |
| 0053<br>IDID                 | The data field of sector IDID has been detected as being bad, and a stop on bad sector data has been requested.   | Press EM (enter) key only to retry this sector, or enter C to abandon this sector. Entering C implies that this sector should subsequently be reformatted using the Reformatting Sectors facility (suggest X = 6 response to the 0045 message). |

Surface Analysis Prompt Messages (cont.)

| Message                                      | Meaning  | Action  |
|--|--|---|
| 0054<br>AAAA<br>BBBB<br>CCCC<br>DDDD<br>EEEE | <p>Facility summary count.</p> <p>The data is the count, in decimal (four digits each), of the number of:</p> <p>AAAA = flagged sectors (see 0051 message).</p> <p>BBBB = flagged sectors with alternatives assigned (see 0051 message).</p> <p>CCCC = sectors with bad IDs (see 0052 message).</p> <p>DDDD = sectors with bad data fields (see 0053 message).</p> <p>EEEE = assigned alternative sectors as read from the disk file label record.</p> | <p>Enter C to continue, unless BBBB is greater than EEEE, in which case contact your service representative.*</p>   |
| 0055   | <p>This message is a request to enter the facility options, in hexadecimal.</p>  | <p>Enter CX or FXIDID.</p> <p>C = analyze the entire disk surface.</p> <p>F = analyze only the single sector at physical address IDID.</p> <p>X = one of the following:</p> <ul style="list-style-type: none"> <li>'1' to stop on sectors with unreadable IDs (see 0052 message).</li> <li>'2' to stop on sectors with bad data fields (see 0053 message).</li> <li>'4' to stop on flagged sectors (see 0051 message).</li> <li>'8' to test only the fixed-head area; not used if a single sector option is selected.</li> <li>'3', '5', '6', '7', or '9' through</li> <li>'F' to identify a combination of options.</li> </ul> |
| BC80   | <p>This message is a request to identify the facility to be executed.</p>  | <p>Go to step 6 of the next facility you wish to execute.</p>   |
| BCB0   | <p>This message is a request to identify the 3604 model number.</p>  | <p>Enter 3604 model number.</p>   |

\*You may then wish to start saving critical data sets, because it may be necessary to clear the disk file to zeros.

### Surface Analysis Error Messages

| Message         | Meaning   | Action   |
|-----------------|---|--|
| 0581            | Unable to read the disk file label record.  | Press the FR (free) key to end, then retry this facility.* |
| 0582<br>D . . D | Unable to initialize the disk file.<br><br>D . . D = data for service representative use. | Enter C to retry this facility.*                           |
| 0583            | Unable to access the diskette for facility information.                                   | Press the FR (free) key to end, then retry this facility.* |
| 0584            | The system cannot access the disk file.   | Press the FR (free) key to end, then retry this facility.* |

\*If, after several retries, the error message continues to be displayed, contact your service representative. You may then wish to start saving critical data sets, because it may be necessary to clear the disk file to zeros.

Place all Problem Recovery pages after this tab.



## **Contents – Problem Recovery**

### **Problem Recovery Procedures**

General

Recovery Procedures Index

Local Location Procedures

Remote Location, External Modem or Integrated 1200-BPS

Remote Loop Procedures

Remote Location, Integrated 600-BPS Remote Loop  
Procedures

### **Problem Report Sheets**

General

3600 System/Controller Problem Report

3604 Problem Report

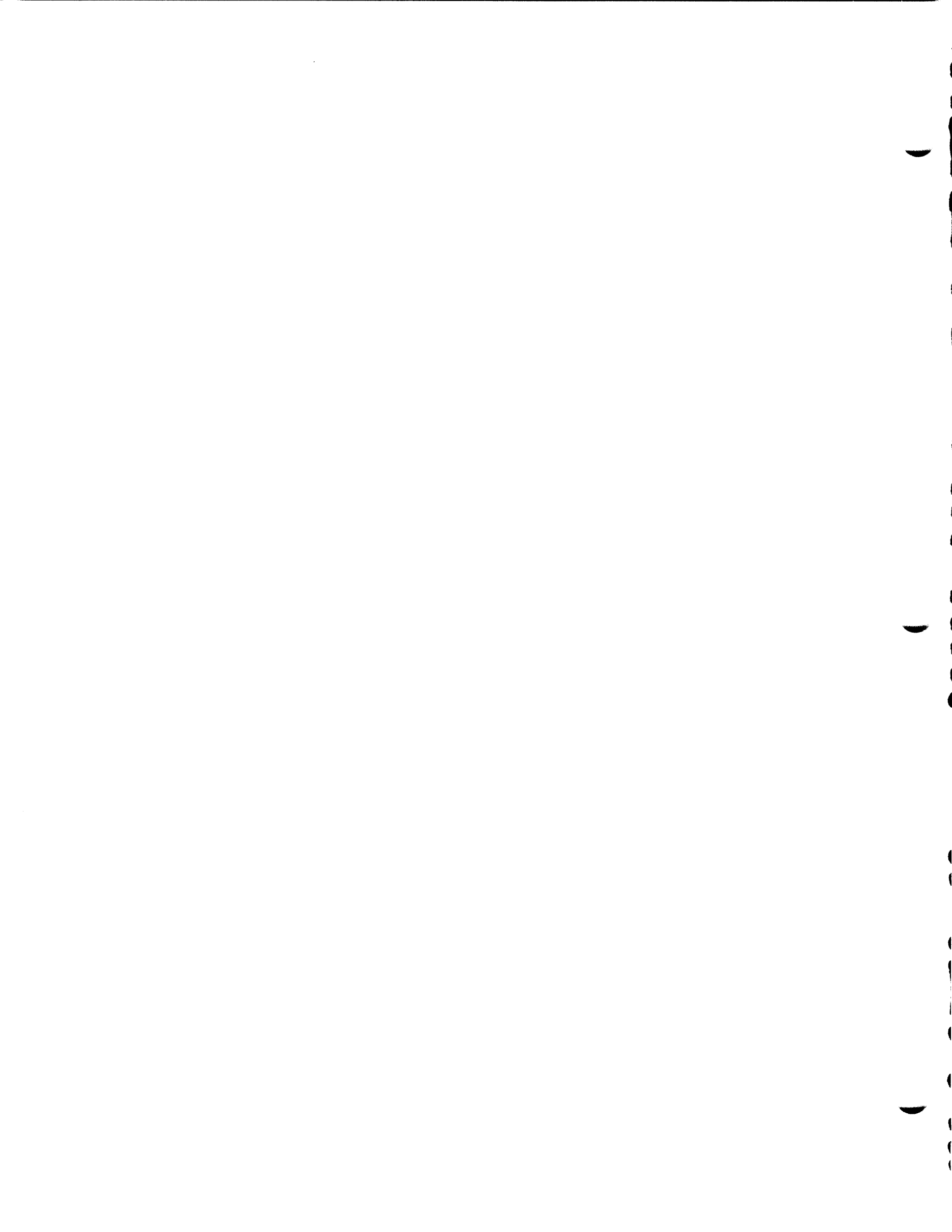
3610 Problem Report

3611 Problem Report

3612 Problem Report

3618 Problem Report

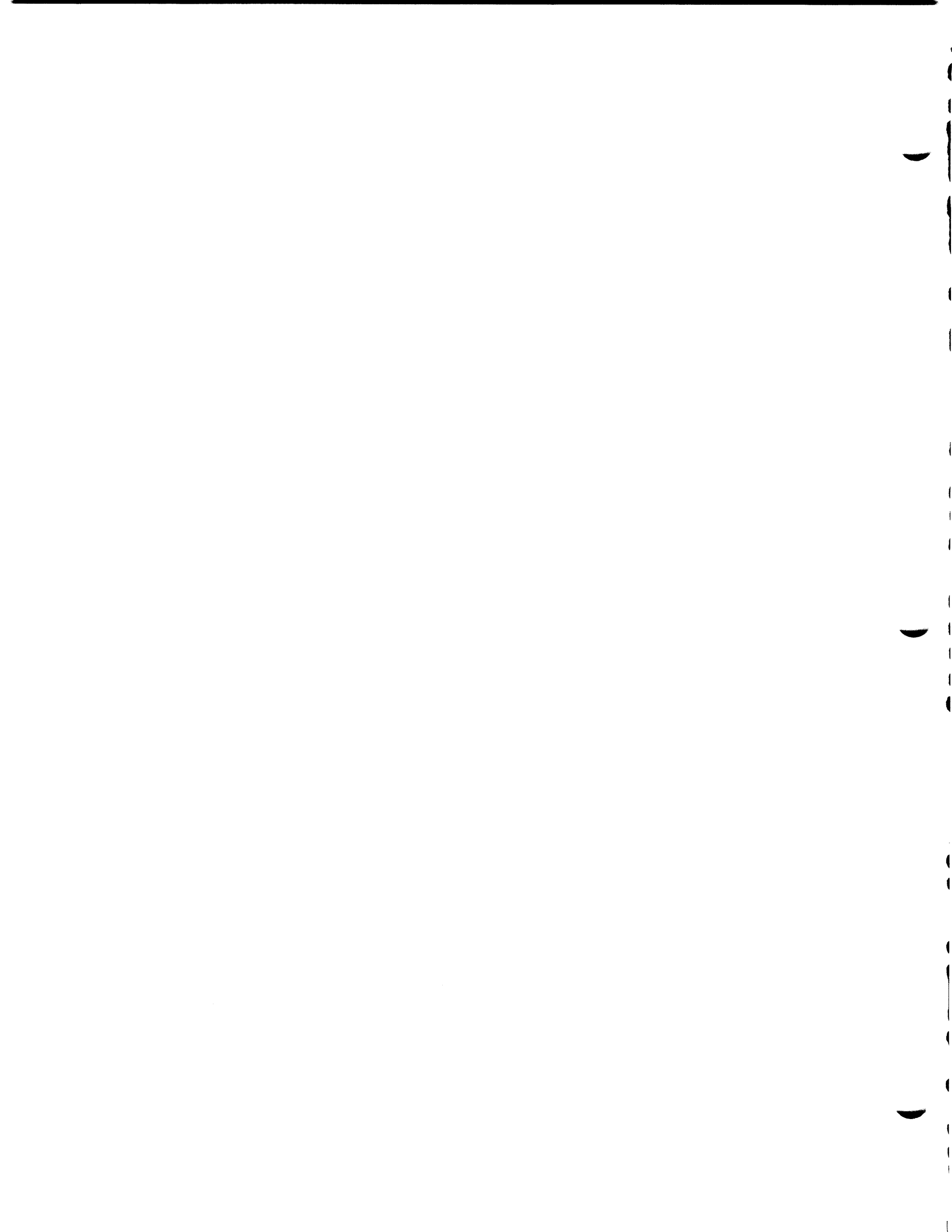
This page follows the Problem Recovery tab.



## Contents – Problem Recovery Procedures

- General
- Recovery Procedures Index
- Local Location Procedures
- Remote Location, External Modem or Integrated 1200-BPS
  - Remote Loop Procedures
- Remote Location, Integrated 600-BPS Remote Loop Procedures

This page precedes the Problem Recovery, Problem Recovery Procedures page 1.



# Problem Recovery Procedures

## GENERAL

The Problem Recovery Procedures help save valuable time by allowing the control operator or other responsible people to resolve a problem or to help determine whether IBM or another supplier is responsible for resolving a problem. In most cases, the Problem Recovery Procedures allow you to narrow down a problem that is affecting an entire loop operation to a failing terminal. The procedures then tell you how to bypass the failing terminal so that you can use the rest of the loop while you are waiting for the service representative (SR) to arrive.

These procedures are designed to identify or locate a problem that may occur in an operational system. The installation checkout procedures for each unit should be used to identify any installation problems.

**Note:** *Always begin with the first symptom of a problem. Don't start pressing keys randomly trying to solve the problem, because you may change the symptom and end up wasting time. Always begin at the start of the procedure or at the point in the procedure you are directed to by the symptom index on page 2.*

The procedures are divided into three parts:

1. Local location procedures.
2. Remote location, external modem or integrated 1200-bps remote loop procedures.
3. Remote location, integrated 600-bps remote loop procedures.  
(The integrated 600-bps remote loop is used in countries other than the USA.)

The Problem Recovery Procedures use a two-column presentation. The left column is the procedure, which consists of steps to do and questions to answer. You do each step or answer each question in the sequence indicated. Each question has a yes (Y) or no (N) answer. Select the appropriate Y or N leg and continue; do not go back unless directed to. On each page, the steps and questions are numbered for easy reference. When the procedure is continued on another page, a two-part numbering scheme is used to direct you: an identifying letter, and the page number within the chapter to go to. For example, the procedure on page 2 continues on page 3. The reference at the bottom of page 2 is  $\frac{3}{F}$ , indicating that you continue at F on page 3. On page 3, the procedure continues with the reference of  $\frac{F}{2}$ , indicating that you came from F on page 2.

The right column gives additional information. This information may tell you why a step is performed, may give information about results, or may refer you to another section of the guide for details. This added information is useful when you first go through the procedure but may not be required after you become familiar with the procedure.

## RECOVERY PROCEDURES INDEX

| <i>Symptom</i>   | <i>Go to Page</i> |
|--|-------------------|
| The READY lights on all the terminals on a local loop are off or flashing.   | 2*                |
| Disk file errors.  | 2*                |
| The local loop is working correctly, but one terminal is failing.  | 20*               |
| During startup, the normal startup message does not get displayed.   | 14*               |
| The controller can't communicate with the central site.  | 40*               |
| On an external modem or integrated 1200-bps remote loop, the READY lights on all the terminals at a remote location are off or flashing.   |                   |
| Remote location procedures.  | 1**               |
| Local location procedures.   | 2*                |
| On an external modem or integrated 1200-bps remote loop, the subloop is working correctly but one terminal is failing.   | 6**               |
| On an external modem or integrated 1200-bps multi-location remote loop, the telephone line operates normally most of the time, but every now and then a problem comes and goes, or the READY lights on all the terminals at the remote locations are on, but the terminals cannot be used. | 34*               |
| On an integrated 600-bps remote loop, the READY lights on all the terminals at a remote location are off or flashing.  |                   |
| Remote location procedures.  | 1†                |
| Local location procedures.   | 38*               |
| On an integrated 600-bps remote loop, the subloop is working correctly but one terminal is failing.  | 5†                |

The system log may provide useful information to clarify the problem. See "Display/Print Controller Log."

Electrostatic discharges can cause some terminals to operate improperly; for example, displays and/or indicators may be blanked or show erroneous information and keyboards may not accept any entries. High static electrical charges can be built up on people and furniture as a result of the action of people, carts, furniture, etc., in contact with furniture or floor coverings. Some contributors to this problem are high-resistance floor surface material, carpeting that does not have anti-static properties, plastic seat coverings, metal frame furniture, or very low humidity.

If, as a result of electrostatic discharges, the display(s) or indicators are operating improperly, retry the transaction or entry that was in process. If the keyboard(s) does not work, press the RESET or CLEAR key, and retry the transaction or entry. If the keyboard still does not work, press each keyboard key in sequential order, starting with the upper-left key and continuing through the keys to the lower-right key. If there are still problems, turn the terminal power off, then on again, and retry the transaction or entry. If all of these attempts fail, the terminal will probably remain inoperable until the next system startup.

---

\*These pages are in the Local Location Procedures.

\*\*These pages are in the External Modem/1200-BPS Remote Loop Procedures.

†These pages are in the 600-BPS Remote Loop Procedures.

This page precedes the Problem Recovery, Local Location Procedures page 1.



1  
2  
3  
4  
5  
6  
7  
8  
9  
10  
11  
12  
13  
14  
15  
16  
17  
18  
19  
20  
21  
22  
23  
24  
25  
26  
27  
28  
29  
30  
31  
32  
33  
34  
35  
36  
37  
38  
39  
40  
41  
42  
43  
44  
45  
46  
47  
48  
49  
50  
51  
52  
53  
54  
55  
56  
57  
58  
59  
60  
61  
62  
63  
64  
65  
66  
67  
68  
69  
70  
71  
72  
73  
74  
75  
76  
77  
78  
79  
80  
81  
82  
83  
84  
85  
86  
87  
88  
89  
90  
91  
92  
93  
94  
95  
96  
97  
98  
99  
100

## LOCAL LOCATION PROCEDURES

These procedures should be located at every local location, that is, a location that has a controller.

Page 2 asks questions to determine the type of problem and directs you to the page for that problem. Pages 2 through 20 deal with local loop problems, and pages 40 and 41 deal with a host link failure.

For remote loop problems (a remote loop is a loop connected to the controller by an external or integrated modem or a 3603), you, as the local control operator, coordinate and assist the people in the remote location when problems arise — if your assistance is needed. Accordingly, pages 21 through 37 deal with external modem or integrated 1200-bps remote loop problems, and pages 38 and 39 deal with integrated 600-bps remote loop problems. (The integrated 600-bps remote loop procedure is not used in the USA; it deals with a loop speed of 600 bps used in other countries.) Advice is given about when to contact the remote location and how to coordinate their efforts, when to gather information about the problem, and who to call for repair.

In these recovery procedures, the READY light on the terminals and the SYNC light on the 3603s play an important role, and many times you are asked to check the condition of these lights.

In the Normal mode, there are only three possible conditions:

1. On (the light is on all the time).
2. Off (the light is off all the time).
3. Flashing (the light is blinking on and off).

In the Wrap Test mode, there are only two possible conditions:

1. On (the light is on all the time).
2. Off (the light is off all the time).

**Note:** *In the Wrap Test mode, if the SYNC light of a 3603 or the READY light of a modem unit should exhibit an occasional flicker, its condition should be considered "on."*

For remote locations, call:

| Location | Telephone No. |
|----------|---------------|
| _____    | _____         |
| _____    | _____         |
| _____    | _____         |
| _____    | _____         |
| _____    | _____         |
| _____    | _____         |

For service, call \_\_\_\_\_ .

For telephone company service, call \_\_\_\_\_ .

START

01 Is local loop 1 operating correctly (the READY lights on all the terminals on the loop on)?

N Y

02 Is any local loop failing?

N Y

03 Is only one terminal on the local loop failing?

N Y

04 Go to A on page 20.

05 Go to G on page 3.

06 Is a remote loop failing?

N Y

07 For a loop using external modems or a 1200-bps remote loop, go to B on page 21.

08 For an integrated 600-bps remote loop, go to C on page 38. See **1**.

09 Is the host link failing (you can not communicate with the host computer)?

Y N

Log on at a 3604 and display the controller log. See "Display/Print Controller Log" and **2**.

Go to D on page 40.

10 Are there other loops attached to this controller?

N Y

11 Are any of the loops working correctly?

N Y

13 Return to question 03 on this page.

14 Did the failure occur during startup?

Y N

14 3

E F

### Notes

**1** This procedure is not used in the USA. It deals with a loop speed of 600 bps used in other countries.

**2**

| Message | Meaning                            | Action  |
|---------|------------------------------------|---|
| 11 001  | Disk file message 90027, 28, or 29 | See the system programmer.                                |
| 11 003  | Application program check          | See the system programmer.                                |
| 11 004  | Controller error                   | Contact your service representative.                      |
| 11 005  | Loop error message                 | Refer to recovery procedure.                              |
| 11 006  | Host link error message            | Refer to recovery procedure.                              |
| 11 007  | Disk file error message            | Run problem identification facility to determine action.* |

\*Procedure for running the disk file problem identification facility (3602 only) using the disk file facilities diskette IBM PN 4944351:

**Note:** *The results of this facility are valid only if the complete procedure is followed from power on or reset. The facility expects to start from a reset condition.*

1. Power off all terminals on loop 1, other than the 3604 at address 1, to prevent interference.
2. Insert the disk file facilities diskette and press the RESET switch.
3. Wait for the BC00 message, then enter the 3604 model number (1, 2, etc.)
4. Wait for the BC80 message, then enter 1010. This command selects and runs all disk file tests that do not require manual intervention; they take about five minutes to run.
5. Messages will be displayed defining machine status:
  - 1000 = Tests completed successfully. Tell the system programmer that you had an 11 007 message, but there is no hardware error.
  - 1080 = Temporarily unable to output to the 3604. This is normal for short periods of time. A stop of 1 minute or more at this point indicates a hardware problem; contact your service representative if this occurs.
  - 10EE = Machine failure. Contact your service representative.
  - 10F0 = Tests are running; take no action.
  - BCXX = Procedure error; correct input and try again. If error persists, contact your service representative.
6. The facility may be ended by pressing the FR (free) key on the 3604.  
**CAUTION: Do NOT press the RESET switch to end the facility.**
7. For any other problem in running this facility, contact your service representative.

G F  
2 2

01 Open the controller's outer hinged cover; is the diskette turning? (If you can't tell if the diskette is turning, take the "N" leg and do checks a-d in step 02.)

Y N

02 At the controller, do the following checks. After each check, see if the diskette starts to turn. If it does, the check you just did corrected the problem. If not, go on to the next check.

- a. Check that the ON/OFF switch is on (press ON).
- b. Check that the diskette drive door is closed.  
See **1**.
- c. Check that the power plug is in all the way in the outlet.
- d. Check that there is power at the outlet. See **2**.

03 Did you get here because in step 01 you couldn't tell if the diskette was turning?

N Y

04 Go to step 06.

05 If the checks in step 02 did not solve the problem:

- Fill out a Problem Report Sheet for the controller.
- Call the SR and report the failing controller.
- Notify the remote locations that the controller is failing.
- End of procedure.

06 Is an 82XXX message displayed?

N Y

07 Go to the "Messages" and follow the instructions for the displayed message.

08 Turn on all the terminals on the local loop.

09 Are the READY lights on on all the terminals?

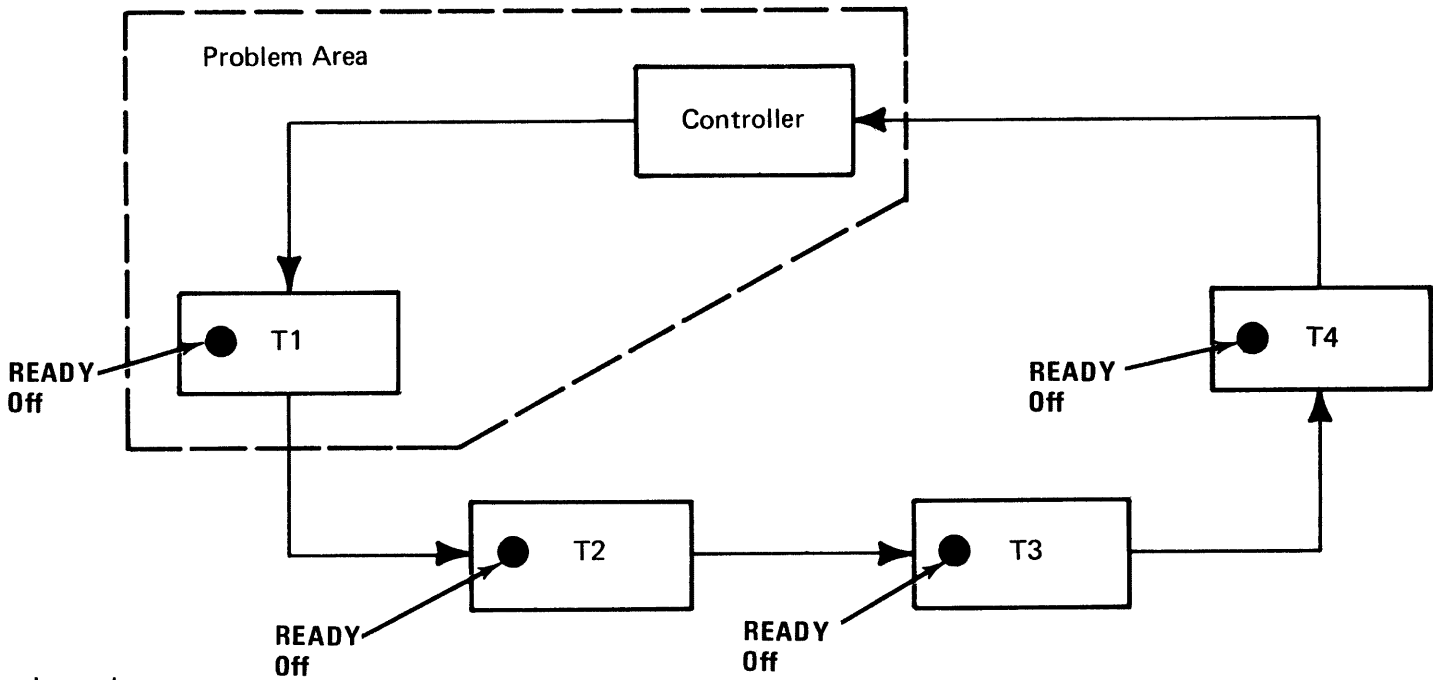
Y N

10 Refer to Figures 1 through 4. Select the figure that shows the condition of the READY lights. Go to the page referenced and follow the procedure on that page.

12  
H

## Notes

- 1** Don't open and close the diskette drive door without checking to see if an 82060 message is displayed on the "control operator 3604." This message relates to a system error that requires information to be written (dumped) on a diskette. If an 82060 message is displayed, go to "Messages" and do the action listed for the message.
- 2** If a lamp or any electrical appliance plugged into the outlet works, the outlet has power. If the outlet does not have power, notify the person responsible for building maintenance.

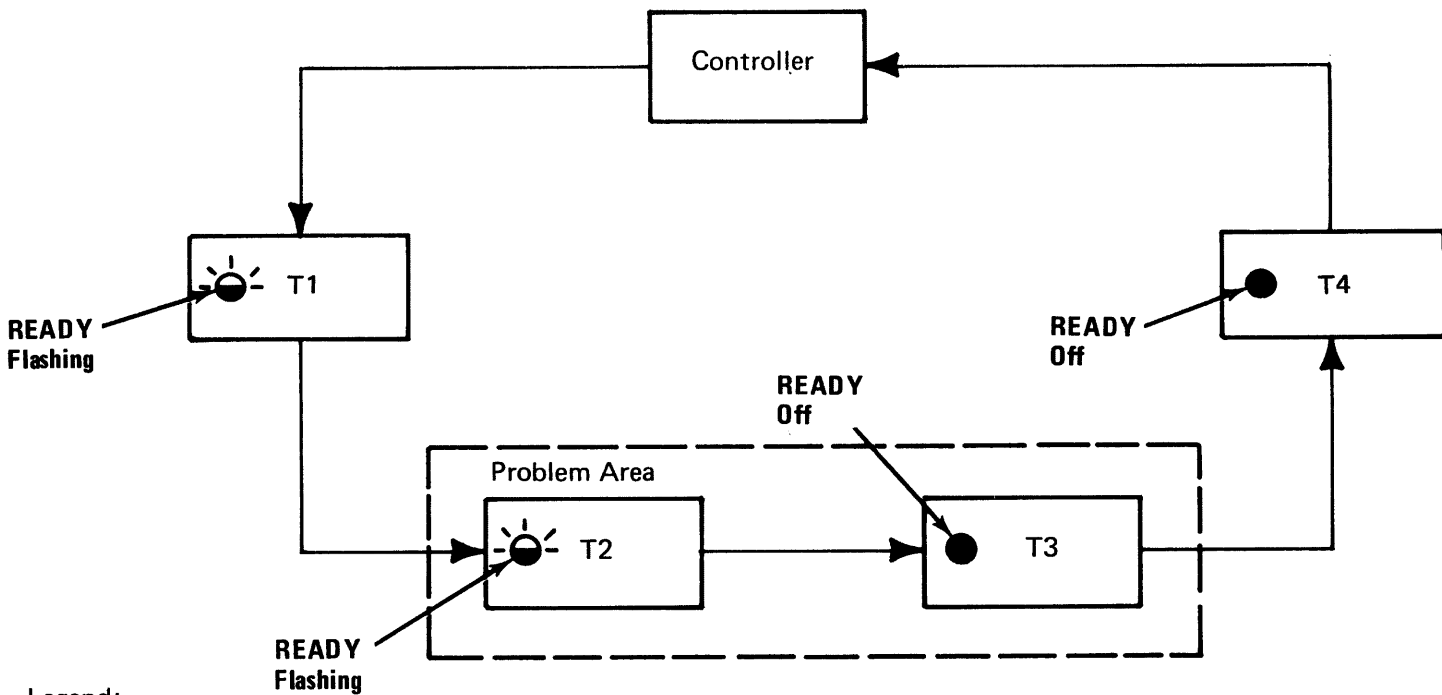


Legend:

- T1 = first terminal on loop.
- T2 = second terminal on loop.
- T3 = third terminal on loop.
- T4 = fourth terminal on loop.

*Note: Refer to the Local Loop Description Sheet for the failing loop to make sure you know which terminals are on the loop and the physical order of the terminals on the loop.*

**Figure 1. All READY lights are off. Go to I on page 6.**



Legend:

- T1 = first terminal on loop.
- T2 = second terminal on loop.
- T3 = third terminal on loop.
- T4 = fourth terminal on loop.

*Note: Refer to the Local Loop Description Sheet for the failing loop to make sure you know which terminals are on the loop and the physical order of the terminals on the loop.*

**Figure 2. Some READY lights are flashing and some are off. Go to J on page 8.**

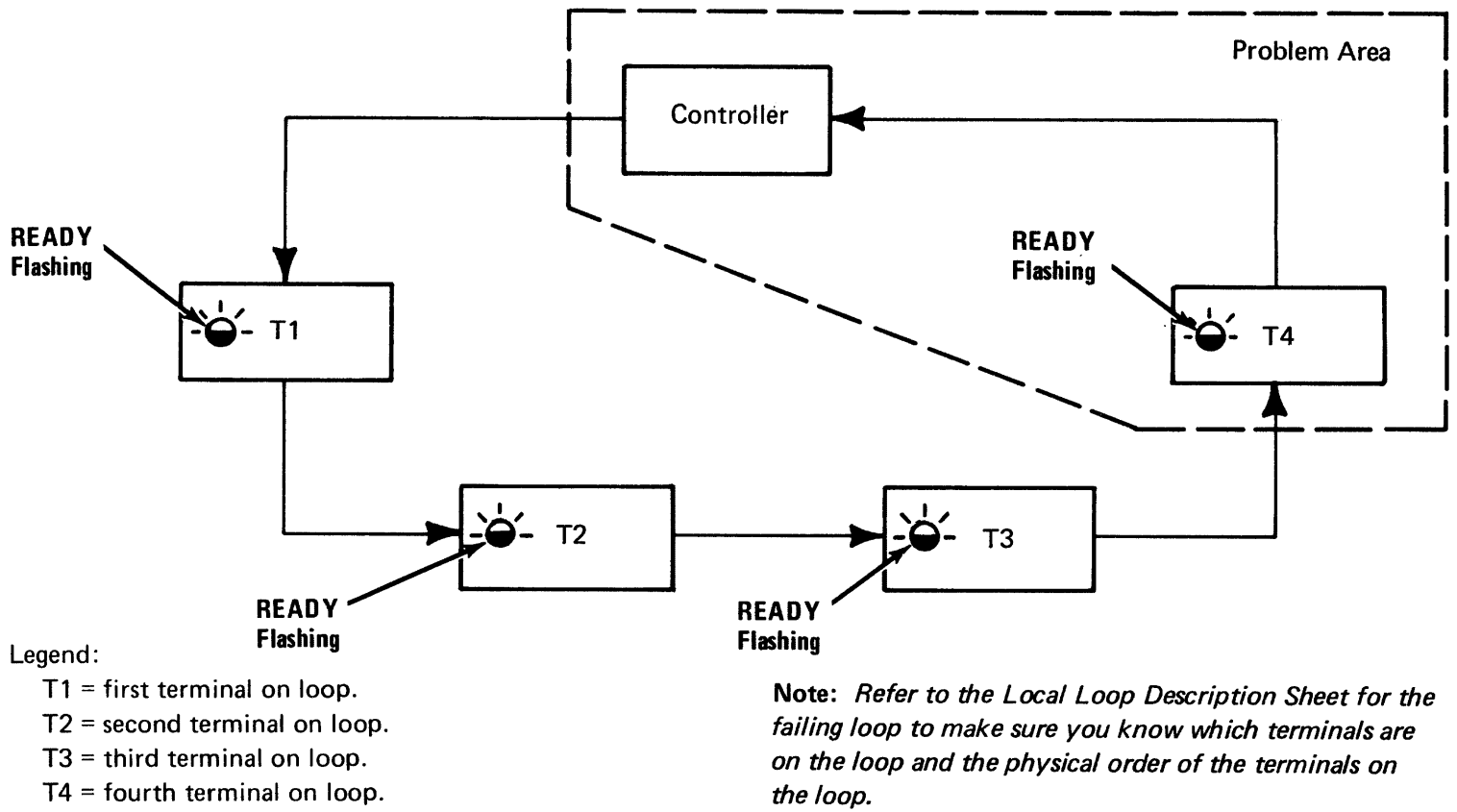


Figure 3. All READY lights are flashing. Go to K on page 11.

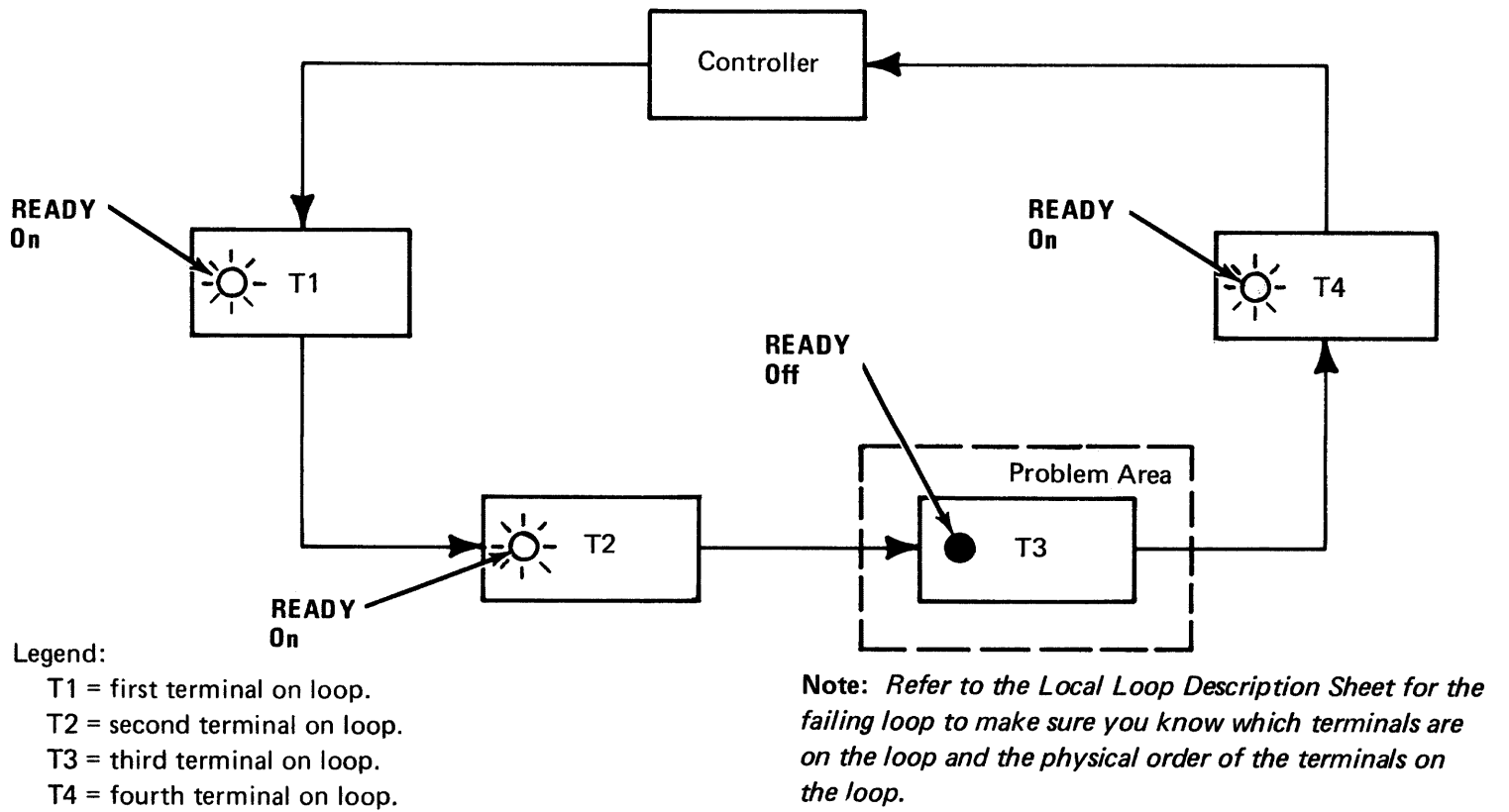


Figure 4. One READY light is off and the others are on. Go to L on page 20.

## Notes

4  
01 Go to the *first terminal on the loop* (T1 in Figure 1) and perform steps a–d below. After each step, check the READY lights on the other terminals on the loop. If the READY lights come on, the step you just did corrected or bypassed the problem.

- a. Check that the speed switches on terminal T1 are set to the correct loop speed. (If T1 is a 3614, skip this step.) See **1**.
- b. If step a did not correct the problem, turn off terminal T1. [If T1 is a 3614, **DON'T TURN IT OFF**, but set its DSBL UNIT switch to the DSBL UNIT position (up position).] If the READY lights on the other terminals on the loop *don't* come on, turn T1 back on and go to step c. If the READY lights *do* come on, terminal T1 is failing. Leave T1 turned off and go to step 02 or 03 on this page.
- c. If terminal T1 is a 3606-1 or 3608-1, unplug the terminal's signal cable from the loop port and plug it in again. If terminal T1 is not a 3606-1 or 3608-1, pull out the loop cables from the terminal and plug them in again. The connectors may not have been fully seated. See **2**.
- d. If step c did not correct the problem, and terminal T1 is a 3606-1 or 3608-1 unplug it from the loop port. If it is not a 3606-1 or 3608-1, pull out the loop cables and plug them together. (If T1 is the only terminal on the loop, go to step 03 on page 7.) If the READY lights on the other terminals on the loop don't come on, plug the terminal back into the loop, and go to step 01 on page 7. If the READY lights do come on, terminal T1 is failing, go to step 02 or 03 on this page.

02 If terminal T1 is a 3606-1 or 3608-1:

- Replace the failing terminal with a spare.
- End of procedure.

03 If terminal T1 is a 3614, refer to the Problem Recovery Procedures in the *3614 Operator's Guide*, GA66-0001.

- Fill out a Problem Report Sheet for the failing terminal.
- Call the SR and report the failing terminal.
- End of procedure.

- 1** The loop speed and address switches are located in different places for different terminals. On the 3604, they are located on the bottom of the terminal; to get at them, you must tip up the 3604. *Have someone help you tip it up.* On the 3606 and 3608, the loop speed, terminal address, and subaddress switches are located behind the red display filter. (The 3606-2 and 3608-2 do not have any loop speed switches.) On the 3610, 3611, 3612, and 3618 printers, the switches are located inside the printer. For the location of the switches on these terminals and for information on the loop speed and address switch settings, see "Loop Speed and Address Switches" under "Installation Details." The 3614 does not have loop speed and address switches; the speed and address are fixed.

**CAUTION:** The loop speed and address setting should be changed only by authorized personnel under the direction of your institution's management.

- 2** To pull out the loop cables, all terminals except the 3606-1, 3608-1, 3614, and 3618 must be tipped up. *Have a second person help you tip up the terminal.* The 3606-1 and 3608-1 can be disconnected from the loop by pulling the connector, on the end of the 6-foot (1.8 m) signal cable attached to the unit, straight out from the loop port. To get at the loop cables on a 3614, open its rear door. On the 3618, face the rear of the printer and reach under the right rear corner. On all terminals, the cables are easily removed by grasping the plugs and pulling straight out.

**CAUTION:** Cables should be removed only by authorized personnel under the direction of your institution's management. If your institution prohibits removing the cables, call your service representative for assistance.



6 (Step 01)

01 If another loop is available, log on a 3604 on that loop and enter a 040 0 command to try to start the loops. See **1**.

02 Are all loops (local and remote) on this controller failing? See **2**.

Y N

03 Is a Loop Repeater installed on the loop between the controller and terminal T1?

N Y

04 Check to see if the Loop Repeater is failing by:

- Unplugging the Loop Repeater from the loop.
- Plugging a spare Loop Repeater into the loop.
- Plugging the power plug of the spare Loop Repeater into an outlet.

05 Is the loop still failing?

Y N

06 Replace the original Loop Repeater with the spare.

- End of procedure.

07 Replace the original Loop Repeater into the loop and continue to step 08.

08 Fill out a Problem Report Sheet for the failing loop(s).

- Tell the service representative that the loop(s) is failing.
- End of procedure.

09 Try to do a restart (press RESET on the controller).

See **3**.

10 Try to do a restart with a backup diskette.

11 If all the loops are still failing:

- Fill out a Problem Report Sheet for the controller.
- Call the SR and report the failing controller.
- End of procedure.

Notes

**1** To log on, press RE (reset) on the 3604 keyboard three times; then respond correctly. For a description of the logon procedure, see "Logon and Logoff."

**2** If all loops attached to a controller are failing, the problem is probably a failure of that controller.

**3** After pressing RESET on the controller, it takes about two minutes to complete the restart operation. At the end of this time and if the restart was successful, 00001 is displayed. For a description of the startup and restart options, see "Startup of the 3600 System."

01 Go to the *last terminal on the loop whose READY light is flashing* (T2 in Figure 2) and perform steps a–d below. After each step, check the READY lights on the other terminals on the loop. If the READY lights come on, the step you just did corrected or bypassed the problem.

- a. Check that the speed switches on terminal T2 are set to the correct loop speed. (If T2 is a 3614, skip this step.) See **1**.
- b. If step a did not correct the problem, turn off terminal T2. [If T2 is a 3614, **DON'T TURN IT OFF**, but set its DSBL UNIT switch to the DSBL UNIT position (up position).] If the READY lights on the other terminals on the loop *don't* come on, turn T2 back on and go to step c. If the READY lights *do* come on, terminal T2 is failing. Leave T2 turned off and go to step 02 or 03 on this page.
- c. If terminal T2 is a 3606-1 or a 3608-1, unplug the terminal's signal cable from the loop port and plug it in again.

If terminal T2 is not a 3606-1 or 3608-1, pull out the loop cables from the terminal and plug them in again. The connectors may not have been fully seated. See **2**.

- d. If step c did not correct the problem, and terminal T2 is a 3606-1 or 3608-1, unplug it from the loop port. If terminal T2 is not a 3606-1 or 3608-1, pull out the loop cables and plug them together.

If the READY lights on the other terminals don't come on, plug the terminal back into the loop, and go to step 01 on page 9. If the READY lights on the other terminals do come on, terminal T2 is failing. Go to step 02 or 03 on this page.

02 If terminal T2 is a 3606-1 or 3608-1:

- Replace it with a spare.
- End of procedure.

03 If terminal T2 is a 3614, refer to the Problem Recovery Procedures in the 3614 Operator's Guide, Form GA66-0001.

- Fill out a Problem Report Sheet for the failing terminal.
- Call the SR and report the failing terminal.
- End of procedure.

**1** The loop speed and address switches are located in different places for different terminals. On the 3604, they are located on the bottom of the terminal; to get at them, you must tip up the 3604. *Have someone help you tip it up.* On the 3606 and 3608, the loop speed, terminal address, and subaddress switches are located behind the red display filter. (The 3606-2 and 3608-2 do not have any loop speed switches.) On the 3610, 3611, 3612, and 3618 printers, the switches are located inside the printer. For the location of the switches on these terminals and for information on the loop speed and address switch settings, see "Loop Speed and Address Switches" under "Installation Details." The 3614 does not have loop speed and address switches; the speed and address are fixed.

**CAUTION:** The loop speed and address setting should be changed only by authorized personnel under the direction of your institution's management.

**2** To pull out the loop cables, all terminals except the 3606-1, 3608-1, 3614, and 3618 must be tipped up. *Have a second person help you tip up the terminal.* The 3606-1 and 3608-1 can be disconnected from the loop by pulling the connector, on the end of the 6-foot (1.8 m) signal cable attached to the unit, straight out from the loop port. To get at the loop cables on a 3614, open its rear door. On the 3618, face the rear of the printer and reach under the right rear corner. On all terminals, the cables are easily removed by grasping the plugs and pulling straight out.

**CAUTION:** Cables should be removed only by authorized personnel under the direction of your institution's management. If your institution prohibits removing the cables, call your service representative for assistance.

01 If the previous steps didn't solve the problem, go to the *first terminal on the loop whose READY light is off* (T3 in Figure 2) and perform steps a–d below. After each step, check the READY lights on the other terminals on the loop. If the READY lights come on, the step you just did corrected or bypassed the problem.

a. Check that the speed switches on terminal T3 are set to the correct loop speed. (If T3 is a 3614, skip this step.) See **1**.

b. If step a did not correct the problem, turn off terminal T3. [If T3 is a 3614, **DON'T TURN IT OFF**, but set its DSBL UNIT switch to the DSBL UNIT position (up position).] If the READY lights on the other terminals on the loop *don't* come on, turn T3 back on and go to step c. If the READY lights *do* come on, terminal T3 is failing. Leave T3 turned off and go to step 08 or 09 on page 10.

c. If terminal T3 is a 3606-1 or 3608-1, unplug the terminal's signal cable from the loop port and plug it in again.

If terminal T3 is not a 3606-1 or 3608-1, pull out the loop cables from the terminal and plug them in again. The connectors may not have been fully seated. See **2**.

d. If step c did not correct the problem, and terminal T3 is a 3606-1 or 3608-1, unplug it from the loop port. If terminal T3 is not a 3606-1 or 3608-1 pull out the loop cables and plug them together.

If the READY lights on the other terminals on the loop don't come on, unplug the cables, plug them back into T3 and go to step 01 on page 10.

If the READY lights do come on, terminal T3 is failing. Go to step 08 or 09 on page 10.

## Notes

**1** The loop speed and address switches are located in different places for different terminals. On the 3604, they are located on the bottom of the terminal; to get at them, you must tip up the 3604. *Have someone help you tip it up.* On the 3606 and 3608, the loop speed, terminal address, and subaddress switches are located behind the red display filter. (The 3606-2 and 3608-2 do not have any loop speed switches.) On the 3610, 3611, 3612, and 3618 printers, the switches are located inside the printer. For the location of the switches on these terminals and for information on the loop speed and address switch settings, see "Loop Speed and Address Switches" under "Installation Details." The 3614 does not have loop speed and address switches; the speed and address are fixed.

**CAUTION:** The loop speed and address setting should be changed only by authorized personnel under the direction of your institution's management.

**2** To pull out the loop cables, all terminals except the 3606-1, 3608-1, 3614, and 3618 must be tipped up. *Have a second person help you tip up the terminal.* The 3606-1 and 3608-1 can be disconnected from the loop by pulling the connector, on the end of the 6-foot (1.8 m) signal cable attached to the unit, straight out from the loop port. To get at the loop cables on a 3614, open its rear door. On the 3618, face the rear of the printer and reach under the right rear corner. On all terminals, the cables are easily removed by grasping the plugs and pulling straight out.

**CAUTION:** Cables should be removed only by authorized personnel under the direction of your institution's management. If your institution prohibits removing the cables, call your service representative for assistance.

N  
9  
|

01 Is a Loop Repeater installed on the loop between terminals T2 and T3?

N Y  
|

02 Check to see if the Loop Repeater is failing by:

- Unplugging the Loop Repeater from the loop.
- Plugging a spare Loop Repeater into the loop.
- Plugging the power plug of the spare Loop Repeater into an outlet.

03 Did the READY lights on the terminals on the loop come on?

N Y  
|

04 Replace the original Loop Repeater with a spare.

- End of procedure.

05 Replace the original Loop Repeater into the loop and continue with step 06.

06 If the previous steps did not solve the problem, replace the loop cable between terminals T2 and T3 if a spare is available (it appears that this cable is failing). See **1**.

07 If the loop is still failing:

- Fill out a Problem Report Sheet for the failing loop.
- Call the SR and report the failing local loop.
- End of procedure.

08 If terminal T3 is a 3606-1 or 3608-1:

- Replace it with a spare.
- End of procedure.

09 If terminal T3 is a 3614, refer to the Problem Recovery Procedures in the *3614 Operator's Guide*, GA66-0001.

- Fill out a Problem Report Sheet for the failing terminal.
- Call the SR and report the failing terminal.
- End of procedure.

## Notes

- 1** To pull out the loop cables, all terminals except the 3606-1, 3608-1, 3614, and 3618 must be tipped up. *Have a second person help you tip up the terminal.* The 3606-1 and 3608-1 can be disconnected from the loop by pulling the connector, on the end of the 6-foot (1.8 m) signal cable attached to the unit, straight out from the loop port. To get at the loop cables on a 3614, open its rear door. On the 3618, face the rear of the printer and reach under the right rear corner. On all terminals, the cables are easily removed by grasping the plugs and pulling straight out.

**CAUTION:** Cables should be removed only by authorized personnel under the direction of your institution's management. If your institution prohibits removing the cables, call your service representative for assistance.

- 01 Go to the *last terminal on the loop* (T4 in Figure 3) and perform steps a–d below. After each step, check the READY lights on the other terminals on the loop. If the READY lights come on, the step you just did corrected or bypassed the problem.
- Check that the speed switches on terminal T4 are set to the correct loop speed. (If T4 is a 3614, skip this step.) See **1**.
  - If step a did not correct the problem, turn off terminal T4. [If T4 is a 3614, **DON'T TURN IT OFF**, but set its DSBL UNIT switch to the DSBL UNIT position (up position).] If the READY lights on the other terminals on the loop *don't* come on, turn T4 back on and go to step c. If the READY lights *do* come on, terminal T4 is failing. Leave T4 turned off and go to step 02 or 03 on this page.
  - If terminal T4 is a 3606-1 or 3608-1, unplug the terminal's signal cable from the loop port and plug it in again. If terminal T4 is not a 3606-1 or 3608-1, pull out the loop cables from the terminal and plug them in again. The connectors may not have been fully seated. See **2**.
  - If step c did not correct the problem, and terminal T4 is a 3606-1 or 3608-1, unplug it from the loop port. If T4 is not a 3606-1 or 3608-1, pull out the loop cables and plug them together. If T4 is the only terminal on the loop or if the READY lights on the other terminals on the loop don't come on, plug the terminal back into the loop, and go to step 01 on page 12. If the READY lights do come on, terminal T4 is failing, go to step 02 or 03 on this page.
- 02 If terminal T4 is a 3606-1 or 3608-1:
- Replace the failing terminal with a spare.
  - End of procedure.
- 03 If terminal T4 is a 3614, refer to the Problem Recovery Procedures in the *3614 Operator's Guide*, GA66-0001.
- Fill out a Problem Report Sheet for the failing terminal.
  - Call the SR and report the failing terminal.
  - End of procedure.

## Notes

- 1** The loop speed and address switches are located in different places for different terminals. On the 3604, they are located on the bottom of the terminal; to get at them, you must tip up the 3604. *Have someone help you tip it up.* On the 3606 and 3608, the loop speed, terminal address, and subaddress switches are located behind the red display filter. (The 3606-2 and 3608-2 do not have any loop speed switches.) On the 3610, 3611, 3612, and 3618 printers, the switches are located inside the printer. For the location of the switches on these terminals and for information on the loop speed and address switch settings, see "Loop Speed and Address Switches" under "Installation Details." The 3614 does not have loop speed and address switches; the speed and address are fixed.

**CAUTION:** The loop speed and address setting should be changed only by authorized personnel under the direction of your institution's management.

- 2** To pull out the loop cables, all terminals except the 3606-1, 3608-1, 3614, and 3618 must be tipped up. *Have a second person help you tip up the terminal.* The 3606-1 and 3608-1 can be disconnected from the loop by pulling the connector, on the end of the 6-foot (1.8 m) signal cable attached to the unit, straight out from the loop port. To get at the loop cables on a 3614, open its rear door. On the 3618, face the rear of the printer and reach under the right rear corner. On all terminals, the cables are easily removed by grasping the plugs and pulling straight out.

**CAUTION:** Cables should be removed only by authorized personnel under the direction of your institution's management. If your institution prohibits removing the cables, call your service representative for assistance.

H O

3 11

01 Is a Loop Repeater installed on the loop between terminal T4 and the controller?

N Y

02 Check to see if the Loop Repeater is failing by:

- Unplugging the Loop Repeater from the loop.
- Plugging a spare Loop Repeater into the loop.
- Plugging the power plug of the spare Loop Repeater into an outlet.

03 Do the READY lights on the terminals come on?

N Y

04 Replace the original Loop Repeater with the spare.

- End of procedure.

05 Replace the original Loop Repeater into the loop and continue to step 06.

06 Fill out a Problem Report Sheet for the failing loop(s).

- Tell the service representative that the loop(s) is failing.
- End of procedure.

07 Are all terminals on the local loop failing? See **1**, **2**.

Y N

08 Check the settings of the speed and address switches on the failing terminals. (If a failing terminal is a 3614, skip this step.) See **3**.

09 At each failing terminal, one at a time, turn it off and then on. (For a failing 3614 skip this step; **DON'T TURN IT OFF.**) See **4**. If these steps didn't correct the problem, go to step 01 or 02 on page 13.

10 Is another loop failing? (If there is only one loop on this controller, take the "N" path.)

Y N

11 Check the settings of the speed and address switches on all terminals on the failing loop. (For failing 3614s, skip this step.) See **3**.

12 Go to the first terminal on the loop, turn it off and check for correct loop operation. [If it is a 3614, **DON'T TURN IT OFF**, but set its DSBL UNIT switch to the DSBL UNIT position (up position).] If the loop does *not* operate correctly, turn the terminal back on and go to the next terminal. Do this at each terminal in turn. If the loop does not operate correctly after you have tried all terminals, turn on all the terminals and go on to step 03 on page 13. If the loop operates correctly after a terminal is turned off or disabled, the terminal you just turned off or disabled is failing. Leave it turned off or disabled and go to step 01 or 02 on page 13.

13 13

P Q

## Notes

- 1** You can decide if all terminals are failing by trying to perform normal operations at the terminals. Or you can try to log on a 3604. If the 3604 CHECK light comes on when you are trying to log on, another 3604 is logged on as the "control operator 3604". If you cannot log on a 3604, take the "Y" path.
  - 2** If all terminals on a loop are failing, the problem is probably a failure of that loop.
  - 3** The loop speed and address switches are located in different places for different terminals. On the 3604, they are located on the bottom of the terminal; to get at them, you must tip up the 3604. *Have someone help you tip it up.* On the 3606 and 3608, the loop speed, terminal address, and subaddress switches are located behind the red display filter. (The 3606-2 and 3608-2 do not have any loop speed switches.) On the 3610, 3611, 3612, and 3618 printers, the switches are located inside the printer. For the location of the switches on these terminals and for information on the loop speed and address switch settings, see "Loop Speed and Address Switches" under "Installation Details." The 3614 does not have loop speed and address switches; the speed and address are fixed.
- CAUTION: The loop speed and address setting should be changed only by authorized personnel under the direction of your institution's management.**
- 4** Turning a terminal OFF and then ON may reset other terminals on the loop. Therefore, try to verify that the other terminals on the loop are not being used before doing this check. If this is not possible, keep this activity to a minimum.

P Q  
12 12

- 01 If the failing terminal is a 3606-1 or 3608-1:
- Replace the failing terminal(s) with a spare(s).
  - End of procedure.
- 02 If the failing terminal is a 3614, refer to the Problem Recovery Procedure in the *3614 Operator's Guide*, GA66-0001.
- Fill out the Problem Report Sheet for the failing terminal(s).
  - Call the SR and report the failing terminal(s).
  - End of procedure.
- 03 Is this the only loop on the controller?
- Y N
- Fill out a Problem Report Sheet for the failing loop.
  - Call the SR and report the failing loop.
  - End of procedure.
- 04 Try to restart with a backup diskette (press RESET on the controller). See **1**, **2**.
- 05 Is the loop still failing?
- Y N
- The problem was the operating diskette.
  - End of procedure.
- 06 Is an error message (82XXX) displayed?
- N Y
- 07 Go to "Messages" and do the actions listed for the displayed error message.
- 08 Are all loops (local and remote) on the controller failing?
- See **3**.
- Y N
- Fill out a Problem Report Sheet for the failing loops.
  - Call the SR and report that more than one loop is failing.
  - End of procedure.
- 09 Try to restart with a backup diskette (press RESET on the controller). See **1**, **2**.
- 10 Did that correct your problem?
- N Y
- The problem was the operating diskette.
  - End of procedure.
  - Fill out a Problem Report Sheet for the controller.
  - Call the SR and report the failing controller.
  - Notify the remote location(s) that the controller is failing.
  - End of procedure.

## Notes

- 1** After pressing RESET on the controller, it takes about two minutes to complete the restart operation. At the end of this time and if the restart was successful, 00001 is displayed. For a description of the startup and restart options, see "Startup of the 3600 System."
- 2** A backup diskette is a second copy of the operating diskette.
- 3** If all the loops attached to a controller are failing, the problem is probably a failure of that controller.



E  
2  
|  
01 Check that the correct diskette is properly inserted and that the diskette door is closed.

02 Is the diskette turning? (If you can't tell if the diskette is turning, take the "N" leg.)

Y N  
|  
03 At the controller, do the following checks. After each check, see if the diskette starts to turn. If it does, the check you just did corrected the problem. If not, go on to the next check.

a. Check that the ON/OFF switch is on (press ON).  
b. Check that the power plug is in all the way in the outlet.  
c. Check that there is power at the outlet. See **1** .

04 If the checks did not solve the problem, see if the diskette is damaged.

05 Is the diskette damaged?

N Y  
|  
06 Try a restart with a **SPARE** diskette to see if the **SPARE** diskette gets damaged; **DO NOT USE THE BACKUP DISKETTE**. See **2** , **3** .

07 Did the spare diskette get damaged?

N Y  
|  
● Fill out a Problem Report Sheet for the controller.  
● Call the SR and report the failing controller.  
● Notify the remote location(s) that the controller is failing.  
● End of procedure.

08 Try a restart with the backup diskette. See **2** , **3** .

## Notes

- 1** If a lamp or any electrical appliance plugged into the outlet works, the outlet has power. If the outlet does not have power, notify the person responsible for building maintenance.
- 2** A backup diskette is a second copy of the operating diskette. A spare diskette is a blank or back-level diskette.
- 3** After pressing RESET on the controller, it takes about two minutes to complete the restart operation. At the end of this time and if the restart was successful, 00001 is displayed. For a description of the startup and restart options, see "Startup of the 3600 System."

R  
14

01 Is the restart with the backup diskette successful?

N Y

02 You have found the problem; the original diskette was bad.

- End of procedure.

03 Did you get here because in step 02 on page 10-14 you couldn't tell if the diskette was turning?

Y N

- Fill out a Problem Report Sheet for the controller.
- Call the SR and report the failing controller.
- Notify the remote location(s) that the controller is failing.
- End of procedure.

04 Is the display blank?

Y N

05 Is DTC displayed?

Y N

06 Go to T on page 18.

07 Go to the "control operator 3604" and:

- Check that the ON/OFF switch is on (press ON).
- Check that the power plug is in all the way in the outlet.
- Check that there is power at the outlet. See **1**.
- Pull out the loop cables and plug them in again (they may be loose). See **2**.

16  
S

## Notes

- 1** If a lamp or any electrical appliance plugged into the outlet works, the outlet has power. If the outlet does not have power, notify the person responsible for building maintenance.
- 2** To pull out the loop cables, all terminals except the 3606-1, 3608-1, 3614, and 3618 must be tipped up. *Have a second person help you tip up the terminal.* The 3606-1 and 3608-1 can be disconnected from the loop by pulling the connector, on the end of the 6-foot (1.8 m) signal cable attached to the unit, straight out from the loop port. To get at the loop cables on a 3614, open its rear door. On the 3618, face the rear of the printer and reach under the right rear corner. On all terminals, the cables are easily removed by grasping the plugs and pulling straight out.

**CAUTION:** Cables should be removed only by authorized personnel under the direction of your institution's management. If your institution prohibits removing the cables, call your service representative for assistance.

S  
15  
|  
01  
02  
N Y  
|  
03  
N Y  
|  
04  
05  
a.  
b.  
c.  
d.  
06  
See 1 .  
07  
N Y  
|  
08  
●  
●  
●  
09  
10  
11  
N Y  
|  
●  
●  
●  
●  
17  
U

01 Do a restart (press RESET on the controller). See **1** .  
02 Is the startup message displayed on the "control operator 3604"?

- You have found and corrected the problem.
- End of procedure.

03 Is another (alternate) 3604 available?

- 04 Turn off the "control operator 3604."  
05 Go to the alternate 3604 and do the following checks:
- Check that the ON/OFF switch is on (press ON).
  - Check that the power plug is in all the way in the outlet.
  - Check that there is power at the outlet. See **2** .
  - Pull out the loop cables and plug them in again (they may be loose). See **3** .

06 Do a restart (press RESET on the controller).  
See **1** .

07 Is the startup message displayed on an alternate 3604?

- 08 The "control operator 3604" is failing.
- Fill out a Problem Report Sheet for the "control operator 3604."
  - Call the SR and report the failing "control operator 3604."
  - End of procedure.

09 Turn on the "control operator 3604."

10 Do a restart with a backup diskette (press RESET on the controller). See **1** , **4** .

11 Was the restart successful?

- You have found and corrected the problem.
- End of procedure.
- Fill out a Problem Report Sheet for the controller.
- Call the SR and report the failing controller.
- Notify the remote location(s) that the controller is failing.
- End of procedure.

### Notes

**1** After pressing RESET on the controller, it takes about two minutes to complete the restart operation. At the end of this time and if the restart was successful, 00001 is displayed. For a description of the startup and restart options, see "Startup of the 3600 System."

**2** If a lamp or any electrical appliance plugged into the outlet works, the outlet has power. If the outlet does not have power, notify the person responsible for building maintenance.

**3** To pull out the loop cables, all terminals except the 3606-1, 3608-1, 3614, and 3618 must be tipped up. *Have a second person help you tip up the terminal.* The 3606-1 and 3608-1 can be disconnected from the loop by pulling the connector, on the end of the 6-foot (1.8 m) signal cable attached to the unit, straight out from the loop port. To get at the loop cables on a 3614, open its rear door. On the 3618, face the rear of the printer and reach under the right rear corner. On all terminals, the cables are easily removed by grasping the plugs and pulling straight out.

**CAUTION:** Cables should be removed only by authorized personnel under the direction of your institution's management. If your institution prohibits removing the cables, call your service representative for assistance.

**4** A backup diskette is a second copy of the operating diskette.

U  
16

01 Turn off all the terminals on the loop except the "control operator 3604"; turn it on. [For a 3614, **DON'T TURN IT OFF** but set its DSBL UNIT switch to the DSBL UNIT position (up position).]

02 Do a restart (press RESET on the controller). See **1**.

03 Was the restart successful?

N Y

04 Turn on the other terminals on the loop, one at a time. Check the operation of the loop as you turn on each terminal. If a terminal causes the loop to fail, turn it off [for a 3614, **DON'T TURN IT OFF** but set its DSBL UNIT switch to the DSBL UNIT position (up position)] and go to step 05 or 06 on this page.

05 If the failing terminal(s) is/are 3606-1 or 3608-1(s):

- Replace the failing terminal(s) with a spare(s).
- End of procedure.

06 If the failing terminal is a 3614, refer to the Problem Recovery Procedures in the *3614 Operator's Guide*, GA66-0001.

- Fill out the Problem Report Sheet for the failing terminal(s).
- Call the SR and report the failing terminal(s).
- End of procedure.

07 Is a Loop Repeater installed on the local loop?

N Y

08 Check to see if the Loop Repeater is failing by:

- Unplugging the Loop Repeater from the loop.
- Plugging a spare Loop Repeater into the loop.
- Plugging the power plug of the spare Loop Repeater into an outlet.

09 Do a restart (press RESET on the controller).

See **1**.

10 Was the restart successful?

N Y

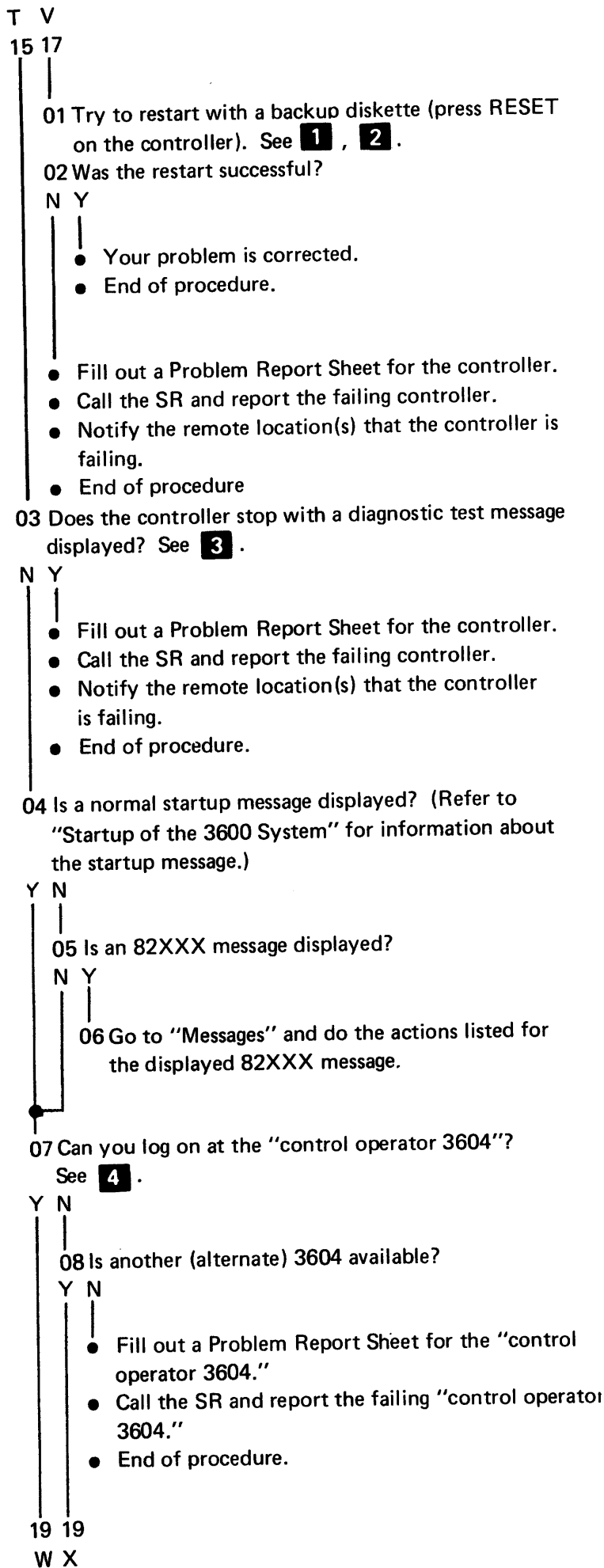
11 Replace the original Loop Repeater with the spare.

- End of procedure.

12 Replace the original Loop Repeater into the loop and continue to step 01 on page 18.

18  
V

- 1** After pressing RESET on the controller, it takes about two minutes to complete the restart operation. At the end of this time and if the restart was successful, 00001 is displayed. For a description of the startup and restart options, see "Startup of the 3600 System."



## Notes

- 1** After pressing RESET on the controller, it takes about two minutes to complete the restart operation. At the end of this time and if the restart was successful, 00001 is displayed. For a description of the startup and restart options, see "Startup of the 3600 System."
- 2** A backup diskette is a second copy of the operating diskette.
- 3** On a startup, a series of diagnostic test messages appears in the upper left corner of the display. Each message is displayed for a number of seconds and is then replaced by the next one. If the startup diagnostic tests detect an error, the startup is terminated and one of these messages is displayed. For more information on startup, see "Startup of the 3600 System."
- 4** Press RE (reset) on the 3604 keyboard three times. then respond correctly. For a description of the logon procedure, see "Logon and Logoff."

W X  
18 18

## Notes

- 01 Turn off the "control operator 3604."  
02 Do a restart with a backup diskette (press RESET on the controller). See **1**, **2**.  
03 Can you log on at an alternate 3604? See **3**.

Y N

- Fill out a Problem Report Sheet for the controller.
  - Call the SR and report the failing controller.
  - Notify the remote location(s) that the controller is failing.
  - End of procedure.
- 
- Fill out a Problem Report Sheet for the "control operator 3604."
  - Call the SR and report the failing "control operator 3604."
  - End of procedure.

04 Is the loop operating normally?

N Y

- You have recovered from the problem.
- End of procedure.

05 Is a 9XXXX message displayed?

N Y

06 Go to "Messages" and do the actions listed for the displayed 9XXXX message.

- Fill out a Problem Report Sheet for the failing loop.
- Call the SR and report the failing loop.
- End of procedure.

- 1** After pressing RESET on the controller, it takes about two minutes to complete the restart operation. At the end of this time and if the restart was successful, 00001 is displayed. For a description of the startup and restart options, see "Startup of the 3600 System."
- 2** A backup diskette is a second copy of the operating diskette.
- 3** Press RE (reset) on the 3604 keyboard three times; then respond correctly. For a description of the logon procedure, see "Logon and Logoff."

- 01 Go to the failing terminal or the terminal whose READY light is off (such as T3 in Figure 4) and do the following checks. After each check, see if the READY light came on. If so, the step you just did corrected the problem. If not, go to the next check.
- Check that the ON/OFF switch is on (press ON).
  - Check that the power plug is in all the way in the outlet.
  - Set the ON/OFF switch to OFF (press OFF); then check that there is power at the outlet. See **1 3**.
  - If the terminal is a 3614, skip the rest of the checks and refer to the Problem Recovery Procedures in the *3614 Operator's Guide, GA66-0001*.
  - Check the setting of the address switches. See **2**.
  - Check that the speed switches are set to the correct loop speed. See **2**.
  - If the terminal is a printer, check that there are forms in the printer and that they are loaded properly. If the terminal is a 3608-1, check that there is no forms jam or obstruction in the forms slot.
  - Check that the covers are closed properly. If the checks did not correct the problem, go to step 02 or 03 on this page.
- 02 If the terminal is a 3606-1 or 3608-1:
- Replace the failing terminal with a spare.
  - End of procedure.
- 03 If the terminal is not a 3606-1 or 3608-1:
- Fill out a Problem Report Sheet for the failing terminal.
  - Call the SR and report the failing terminal.
  - End of procedure.

## Notes

- 1 If a lamp or any electrical appliance plugged into the outlet works, the outlet has power. If the outlet does not have power, notify the person responsible for building maintenance.
- 2 The loop speed and address switches are located in different places for different terminals. On the 3604, they are located on the bottom of the terminal; to get at them, you must tip up the 3604. *Have someone help you tip it up.* On the 3606 and 3608 the loop speed, terminal address, and subaddress switches are located behind the red display filter. (The 3606-2 and 3608-2 do not have any loop speed switches.) On the 3610, 3611, 3612, and 3618 printers, the switches are located inside the printer. For the location of the switches on these terminals and for information on the loop speed and address switch settings, see "Loop Speed and Address Switches" under "Installation Details." The 3614 does not have loop speed and address switches; the speed and address are fixed.

**CAUTION:** The loop speed and address setting should be changed only by authorized personnel under the direction of your institution's management.

- 3 Turning the terminal off and then on may reset other terminals on the loop. Therefore, try to verify that the other terminals on the loop are not being used before doing this check. If this is not possible, keep this activity to a minimum.



When an external modem or integrated 1200-bps remote loop fails, the problem could be caused by a failure:

- within the controller, an external modem, or a local 3603;
- the telephone lines interconnecting the locations, or
- a modem, 3603, modem unit (see **1**) and/or terminals at a remote location.

To help you and the remote control operator determine the location of the problem, "wrap tests" can be performed at the local location and each remote location.

At your location, when the controller detects a loop failure, it automatically does a wrap test. That is, the controller generates a signal that checks the controller, checks its modem (integrated and some external modems), and returns (wraps) to the controller. If the wrap test is successful, it means that the controller and its tested modem are OK and the problem is not at your location. (Where a 3603 or an external modem that cannot be automatically wrap-tested is used, only the test of the controller is valid.) The results of this wrap test are recorded in a 11 005 message in the controller log. To display the controller log, enter a 001 command. With a local 3603, one can manually perform a wrap test by pulling out the loop cable connectors upwards from the top of the 3603 and plugging them together. This will bypass the 3603 and the rest of the remote loop attached to it. If the loop still fails, go to step 02 on page 2 and test the loop in its present form as a local loop. If the loop does not fail, the 3603 can itself be tested by manually moving the Wrap Test toggle switch from NORMAL to WRAP UNIT. (See **2**, **3**.) A successful test of the 3603 will be indicated if the SYNC light comes on. If the test of the 3603 is unsuccessful, the unit is failing. Replace the failing 3603 with a spare.

At remote location(s), the remote control operator does a similar wrap test to check out the modem unit and terminals. If the remote locations are subscriber locations, the local control operator must contact each subscriber on the failing loop at which a remote 3603 is installed to perform a wrap test and report the results.

If the wrap test at the local and remote location(s) are successful, a telephone line(s) is apparently failing.

## Notes

- 1** In these recovery procedures, a unit that can interface directly with telephone lines or a modem is called a "modem unit." The units in the 3600 system that can interface directly with telephone lines or a modem are: the 3603; the 3604-2, -3, -4; the 3606-2; the 3608-2; and any 3614 model. You can recognize a 3604 modem unit because it has a TEST UNIT/DSBL UNIT switch to the right of the keyboard. A 3606-2 modem unit has a DSBL/TEST switch on its right side. A 3608-2 modem unit has a DSBL UNIT/TEST UNIT switch on its front face. A 3614 modem unit has a TEST UNIT switch behind its rear door. The 3603 modem unit is a small wall-mounted unit that has a single toggle switch and SYNC light (the 3603-1 also has a rotary selector switch) on its front panel.
- 2** **CAUTION:** To change the switch setting of the Wrap Test toggle switch, it is necessary to pull outward on the toggle handle to unlock it before attempting to reset it. This built-in locking feature prevents the setting of the switch from being accidentally altered.
- 3** Never set the Wrap Test toggle switch on a 3603 that is installed at a local site to the WRAP UNIT/LOOP position. The resulting indication on the 3603 SYNC light will not be valid. Also, the results of any automatic wrap tests conducted by the controller while the Wrap Test toggle switch is in this position will be invalid.

The remote control operator(s) are told by their procedures to contact the local control operator and report the results obtained with their procedures.

Remote subscriber locations should be instructed, by their procedures, to not initiate *any* corrective action. If they cannot complete a transaction following normal procedures, they should be instructed to contact a "service operator" in your institution, who will assist them in completing the transaction and in the process obtain information on trouble symptoms. The service operator should immediately notify the local control operator responsible for the remote loop that is failing and relay information on trouble symptoms. The local control operator is responsible for contacting subscriber locations for status information and should use the following procedures to isolate the problem and know whom to call for repair.

01 Is the problem a degraded telephone line (problems come and go) in a multi-location remote loop?

N Y  
| |  
02 Go to Z on page 34.

03 Are the READY lights at all the terminals on?

N Y  
| |  
04 Are all the terminals failing?

N Y  
| |  
● 05 Go to Z on page 34.

06 Check that the phone connections are correct and secure. See **1**.

07 Log on the "control operator 3604" and enter a 040 0 command to start all loops that are stopped. See **2**.

08 Is the remote loop now working correctly (the READY lights are on and you can do normal functions)?

N Y  
| |  
● The problem has been solved, the loop was stopped.  
● End of procedure.

Notes

- 1** In these recovery procedures, a unit that can interface directly with telephone lines or a modem is called a "modem unit." The units in the 3600 system that can interface directly with telephone lines or a modem are: the 3603; the 3604-2, -3, or -4; the 3606-2; the 3608-2; and any 3614 model. You can recognize a 3604 modem unit because it has a TEST UNIT/DSBL UNIT switch to the right of the keyboard. A 3606-2 modem unit has a DSBL/TEST switch on its right side. A 3608-2 modem unit has a DSBL UNIT/TEST UNIT switch on its front face. A 3614 modem unit has a TEST UNIT switch behind its rear door. The 3603 modem unit is a small wall-mounted unit that has a single toggle switch and SYNC light (the 3603-1 also has a rotary selector switch) on its front panel.
- 2** Press RE (reset) on the 3604 keyboard three times; then respond correctly. For a description of the logon procedure, see "Logon and Logoff."



01 Is the failing remote loop a multi-location loop?

See **1**.

Y N

02 Contact the remote location. Was the Wrap Test successful? See **2**, **3**.

Y N

03 Is the remote subloop at this location attached to a 3603?

N Y

04 Was the WRAP UNIT Wrap Test successful?

N Y

05 The remote 3603 is OK. The attached remote subloop is failing.

- Have the subscriber or remote control operator reset the Wrap Test toggle switch to NORMAL and unplug the remote subloop from the top of the 3603 to restore operation to the loop.
- Notify the installation/repair man employed by your institution of the failing remote subloop.
- End of procedure.

06 The 3603 at this location is failing, call the installation/repair man employed by your institution and report the failing subloop.

- End of procedure.

07 If the remote subloop consists of a 3606-2 or a 3608-2, the terminal is failing.

- Call the installation/repair man employed by your institution and report the failing terminal.
- End of procedure.

08 If the remote subloop is attached to a 3604 or 3614, call the SR and report the failing subloop.

- End of procedure.

09 If there is an external modem, perform its test procedures, and, if it fails, contact the SR for it. If it passes, call the telephone company and tell them there is a telephone line failure between your location and the remote location.

- End of procedure.

Notes

**1** For multi-location remote loops you, as the local control operator, must coordinate the actions of the remote control operators.

**2** At the remote location, ask the remote control operator, if the remote modem unit is:

- a 3603, to set the Wrap Test toggle switch to the WRAP UNIT/LOOP position, and then to the WRAP UNIT position.
- a 3604, to press TEST UNIT of the TEST UNIT/DSBL UNIT switch.
- a 3606-2, to press TEST of the blue DSBL/TEST switch
- a 3608-2, to press TEST UNIT of the blue DSBL UNIT/TEST UNIT switch.
- a 3614, to press the TEST UNIT switch to the TEST UNIT position.

A successful wrap test of the remote modem unit and the attached remote subloop indicates that the problem is not within this remote subloop.

**3** **CAUTION:** To change the switch setting of the Wrap Test toggle switch on the 3603, it is necessary to pull outward on the toggle handle to unlock it before attempting to reset it. This built-in locking feature prevents the setting of the switch from being accidentally altered.

01 Contact the remote locations attached to the failing remote loop. See **1**. As you call, record the status of the READY light (off or flashing) of the modem unit (the SYNC light of the 3603) in NORMAL mode, and the results of the wrap test. See **2**, **3**, **4**, **5**.

02 Is the wrap test successful?

Y N

03 This remote location is failing. Go to step 01 on page 26.

04 In the NORMAL mode, is the status of the READY light of the modem unit (the SYNC light of the 3603) the same as that of the previously called remote location? (If this is the first location called, assume the controller location is the previously called location and that the status of its READY light is flashing.)

Y N

05 Is there another location(s) on this loop between these two locations?

N Y

06 Select a location midway between these two to contact next, and go back to step 01 on this page.

07 The telephone line between these two sites is failing.

08 Call the telephone company and tell them of the failing telephone line, and identify the location at each terminus.

09 Are the remote locations at each end of the failing telephone line attached to a 3603-1 with at least one DAA each?

Y N

● End of procedure.

10 To establish communications over the switched network and bypass the failing leased line, go to step 01 on page 31.

11 Select another location between this location and the controller in a direction along the loop away from the previously called location and go back to step 01 on this page. If this is the last location on this remote loop, go back to step 05 on this page.

**1** If the failing remote loop is one to which you have subscribers attached, use the location status reports that you receive from the "service operator" to indicate which remote location to contact first. For example, in the *Normal* mode:

- A READY (or SYNC) light flashing on a remote modem unit is generally indicative of an interruption of the data flow path after that remote location.
- A READY (or SYNC) light off on a remote modem unit is indicative of an interruption of the data flow path *within* or *before* that remote location (see Figure 5, 6, and 7). Using a binary search technique, one can rapidly isolate the failing loop element to the failing remote location or the failing communications link with a minimum number of calls.

**2** In these recovery procedures, a unit that can interface directly with telephone lines or a modem is called a "modem unit." The units in the 3600 system that can interface directly with telephone lines or a modem are: the 3603; the 3604-2, -3, or -4; the 3606-2; the 3608-2; and any 3614 model. You can recognize a 3604 modem unit because it has a TEST UNIT/DSBL UNIT switch to the right of the keyboard. A 3606-2 modem unit has a DSBL/TEST switch on its right side. A 3608-2 modem unit has a DSBL UNIT/TEST UNIT switch on its front face. A 3614 modem unit has a TEST UNIT switch behind its rear door. The 3603 modem unit is a small wall-mounted unit that has a single toggle switch and SYNC light (the 3603-1 also has a rotary selector switch) on its front panel.

**3** NORMAL mode for the . . .

- 3603 modem unit is when the Wrap Test toggle switch is set to NORMAL.
- 3604 modem unit is when the TEST UNIT/DSBL UNIT switch is in the normal position.
- 3606-2, modem unit is when the blue DSBL/TEST switch is in the normal position.
- 3608-2 modem unit is when the blue DSBL UNIT/TEST UNIT switch is in the normal position.
- 3614 modem unit is when the TEST UNIT switch is in the normal position.

**4** }  
**5** } See page 26 for notes 4 and 5.

AD  
25

01 Is the remote subloop at this failing location attached to a 3603?

N Y

02 Was the WRAP UNIT wrap test successful?

N Y

03 The remote 3603 is OK. The attached remote subloop is failing.

- Have the subscriber or remote control operator reset the Wrap Test toggle switch to NORMAL and unplug the hard-wire remote subloop from the top of the 3603 to restore loop operation.
- Notify the installation/repair man employed by your institution of the failing remote subloop.
- End of procedure.

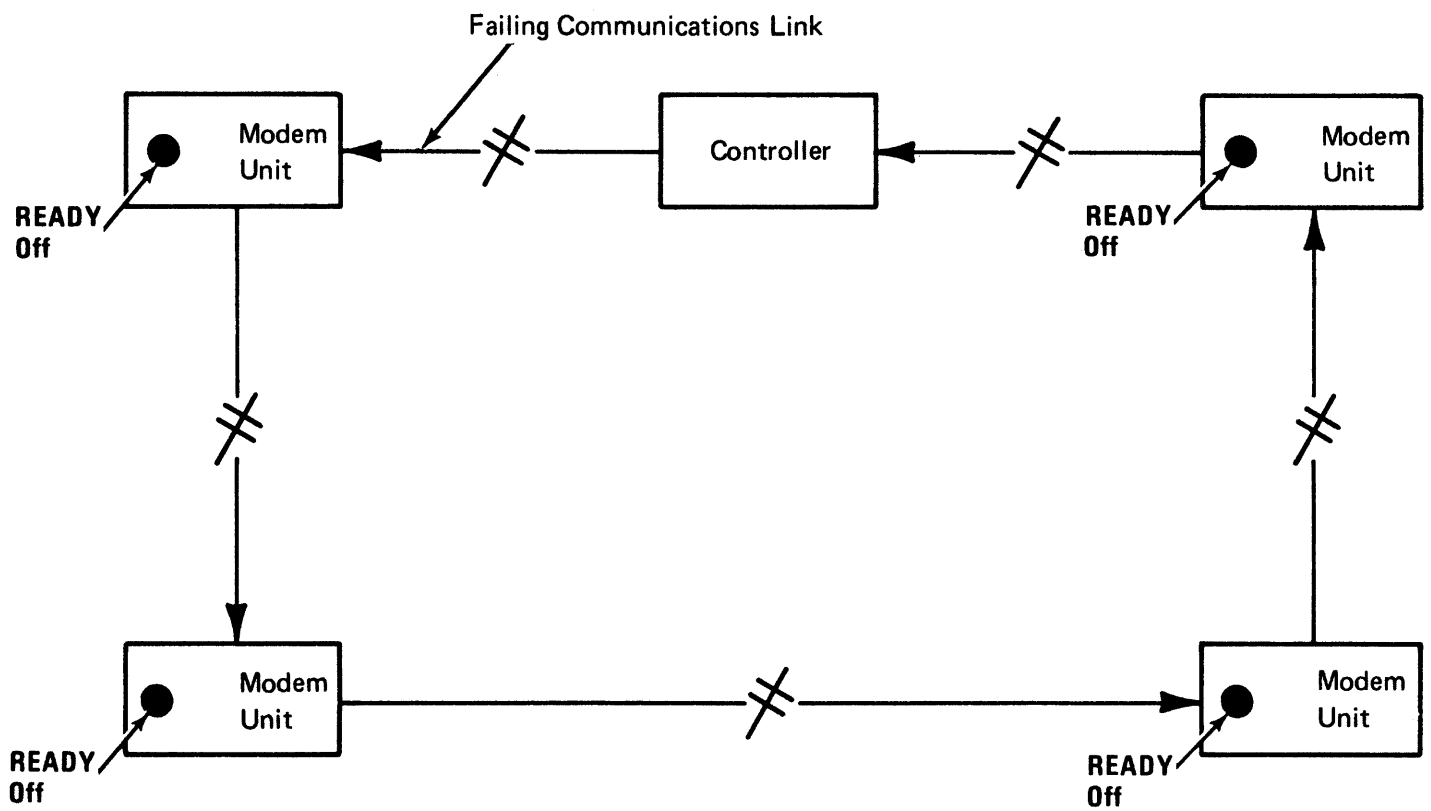
**4** At the remote location, ask the remote control operator, if the remote modem unit is:

- a 3603, to set the Wrap Test toggle switch to the WRAP UNIT/LOOP position, and then to the WRAP UNIT position.
- a 3604, to press TEST UNIT of the TEST UNIT/DSBL UNIT switch.
- a 3606-2, to press TEST of the blue DSBL/TEST switch
- a 3608-2, to press TEST UNIT of the blue DSBL UNIT/TEST UNIT switch.
- a 3614, to press the TEST UNIT switch to the TEST UNIT position.

A successful wrap test of the remote modem unit and the attached remote subloop indicates that the problem is not within this remote subloop.

**5 CAUTION:** To change the switch setting of the 3603 Wrap Test toggle switch, it is necessary to pull outward on the toggle handle to unlock it before attempting to reset it. This built-in locking feature prevents the setting of the switch from being accidentally altered.

30 30  
AE AF

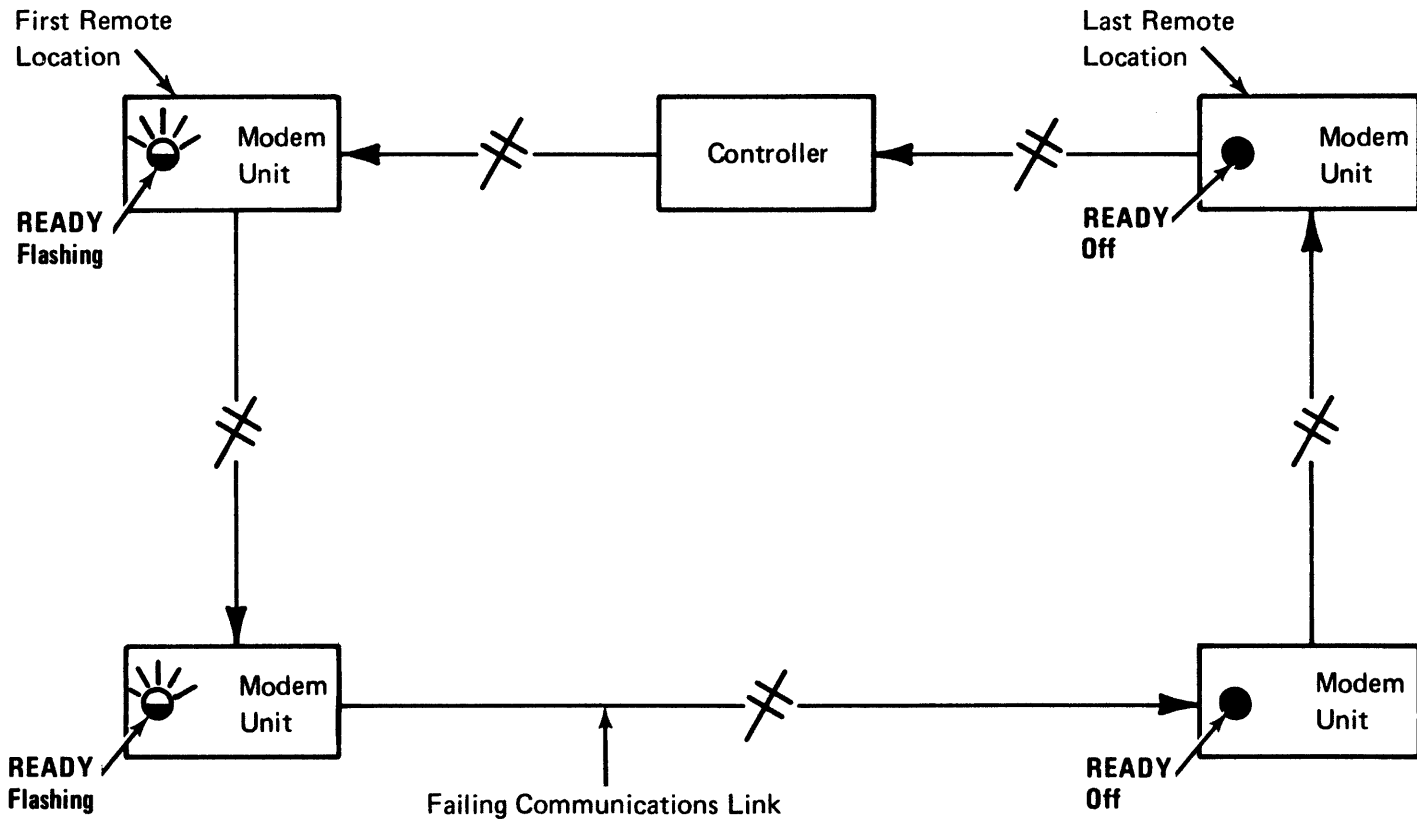


**Notes:**

- 1 The failing communications link is the one connecting the controller and the first remote location.
- 2 Refer to the Remote Loop Location Directory for information about the remote location and the physical order of the remote location on the remote loop.

**Figure 5.** The READY lights on the modem units are off.

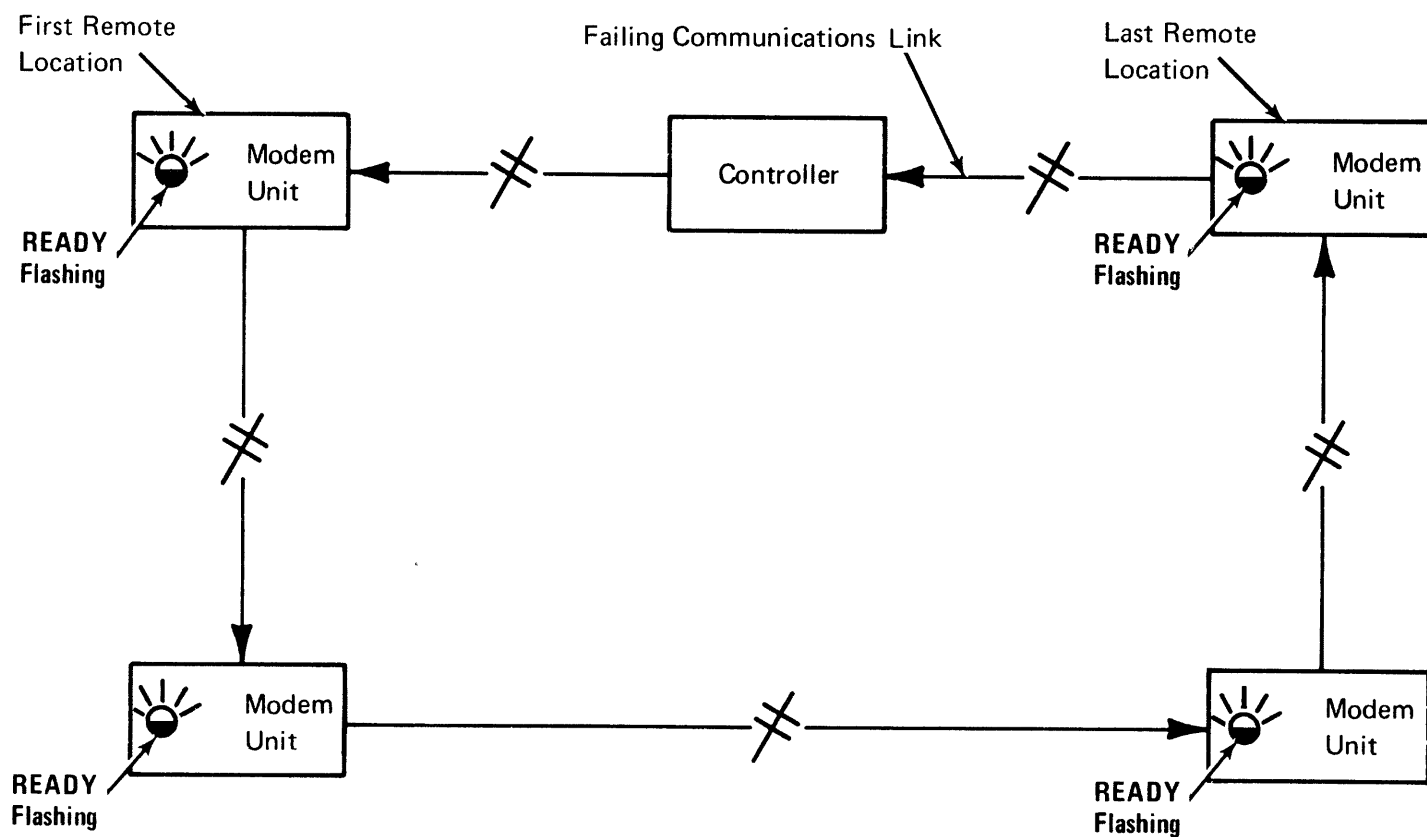




**Notes:**

- 1 The failing communications link is the one connecting the last modem unit whose READY light is flashing and the first modem unit whose READY light is off.
- 2 Refer to the Remote Loop Location Directory for information about the remote location and the physical order of the remote location on the remote loop.

**Figure 6.** The READY lights on some modem units are flashing and some are off.



**Notes:**

- 1 The failing communications link is the one connecting the last remote branch and the controller.
- 2 Refer to the Remote Loop Locations Directory for information about the remote locations and the physical order of the remote locations on the remote loop.

Figure 7. The READY lights on the modem units are flashing.

AE AF  
26 26

01 Do the remote locations, on both sides of the failing location have a 3603-1 with Data Access Arrangements?

N Y

02 To establish communications via the switched network to bypass the failing location, go to step 01 on page 31.

03 Notify the remaining locations on this remote loop of the problem and of the estimated time that the loop will be restored.

- 04 ● If there is an external modem at the failing location, perform its test procedures and, if it fails, contact the SR for it.
- If the remote location has a 3606-2 or a 3608-2 modem unit, notify the remaining locations on this remote loop of the problem and of the estimated time that the loop will be restored.
  - If the remote subloop is attached to a modem unit other than a 3603, 3606-2, or 3608-2, call the SR and report the failing location.
  - End of procedure.

25 (step 10) or  
30 (step 02)

- 01 The following procedure is recommended for bypassing a failing telephone line or failing location if the adjacent remote locations are equipped with a 3603-1 modem unit with at least one Data Access Arrangement (DAA) attached. (See Figure 8 or 9.)
- Check that the rotary selector switch on the standby 3603-1 is set to TSMT/REC.
  - Dial a communications link with the secondary DAA telephone on your standby 3603 to the primary DAA at "site S" (See Figure 8 or 9.) See **1**.
  - Have the subscriber first set the rotary selector switch on his 3603-1 to TRANSMIT and then pull up the white button on the cradle of his DAA telephone to establish the data link and uncouple his telephone. (You should hear a steady tone on your DAA telephone when the subscriber pulls up the white button). See **2**.
  - Pull up the white button on the cradle of the telephone of your secondary DAA. See **2**.
  - Dial a communications link with the primary DAA telephone on your standby 3603-1 to the primary DAA at "site T." (See Figure 8 or 9.) See **1**.
  - Have the subscriber first set the rotary selector switch on his 3603-1 to RECEIVE and then pull up the white button on the cradle of his DAA telephone to establish the data link and uncouple his DAA telephone. See **2**.
  - Pull up the white button on the cradle of the telephone of your primary DAA. See **2**. The SYNC light on the standby 3603-1 should come on, indicating that the loop is operational. See **3**.

## Notes

- 1** After voice communication has been established, if either party experiences difficulty in hearing the other, or if the communications channel is noisy (i.e., the presence of static or cross talk), both parties should hang up, and you should redial the connection.
- 2** Caution the subscriber *not* to hang up the hand piece of the telephone on the cradle after establishing the data link, as this will break the connection and you will have to dial up again.
- 3** If these procedures have been followed properly and the loop is not operational, it is probably due to a poor connection in one of the dialed links. It will be necessary to repeat the procedure.

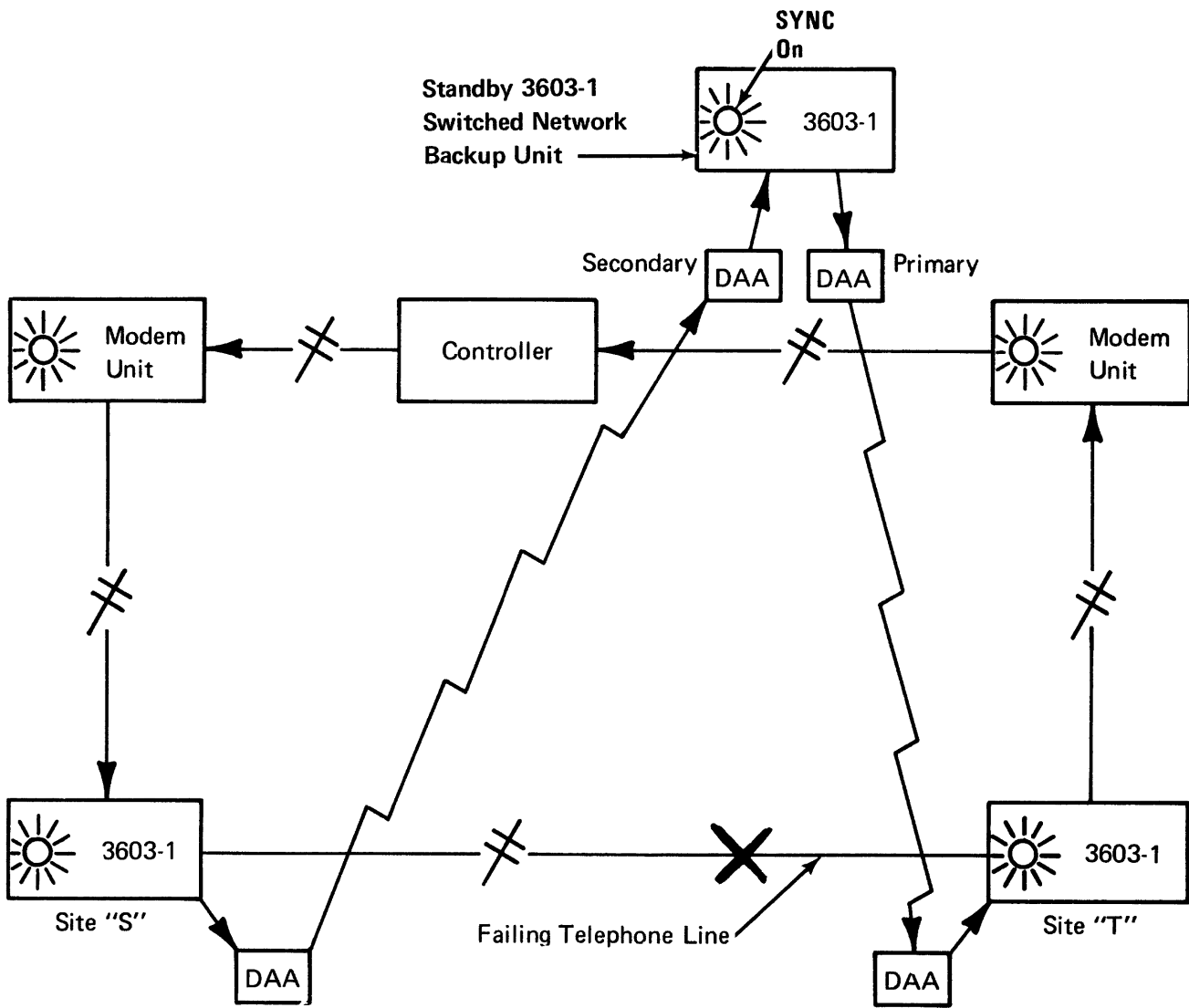


Figure 8. Bypassing a Failing Telephone Line Using the Switched Network

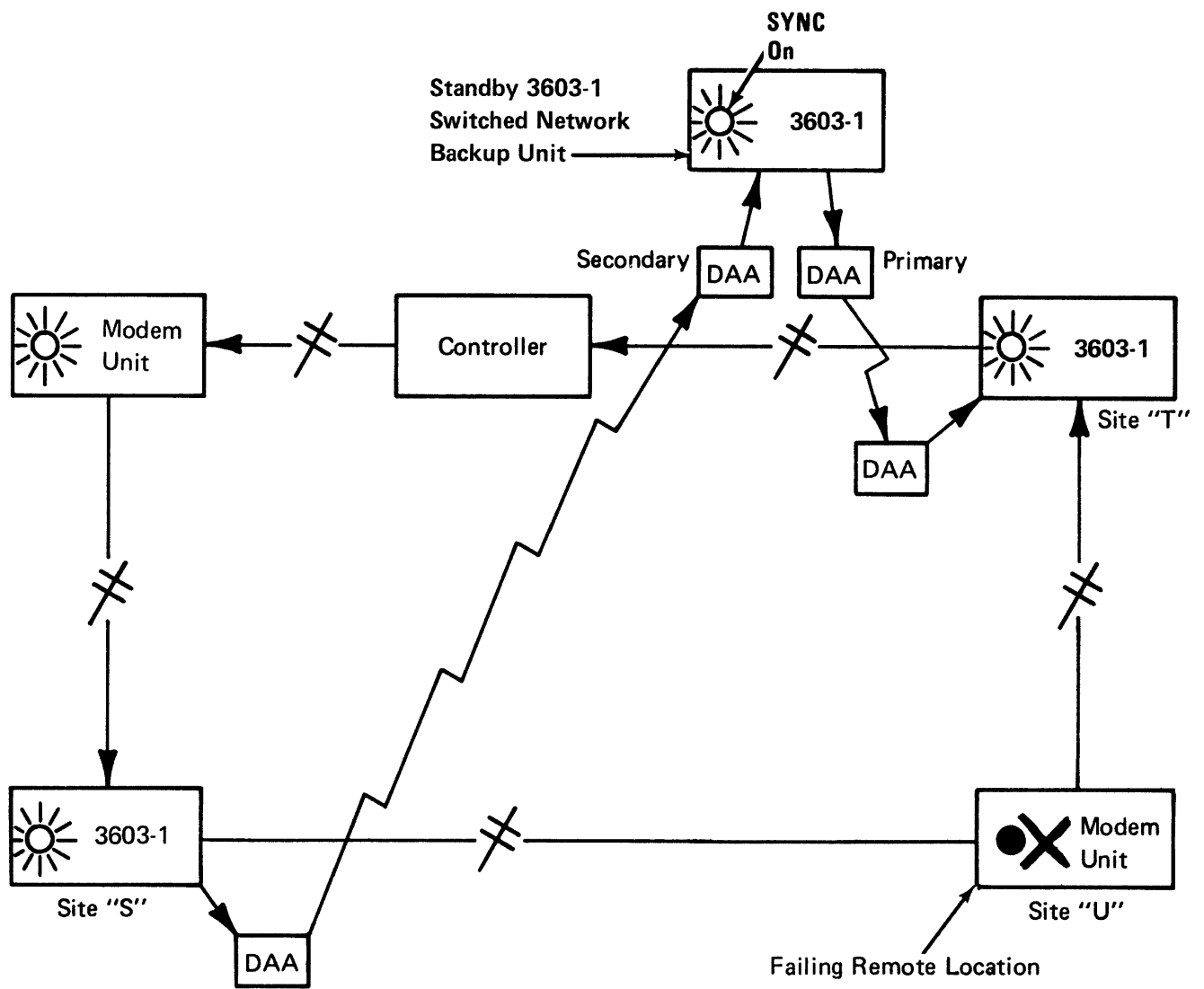


Figure 9. Bypassing a Failing Remote Location with the Switched Network

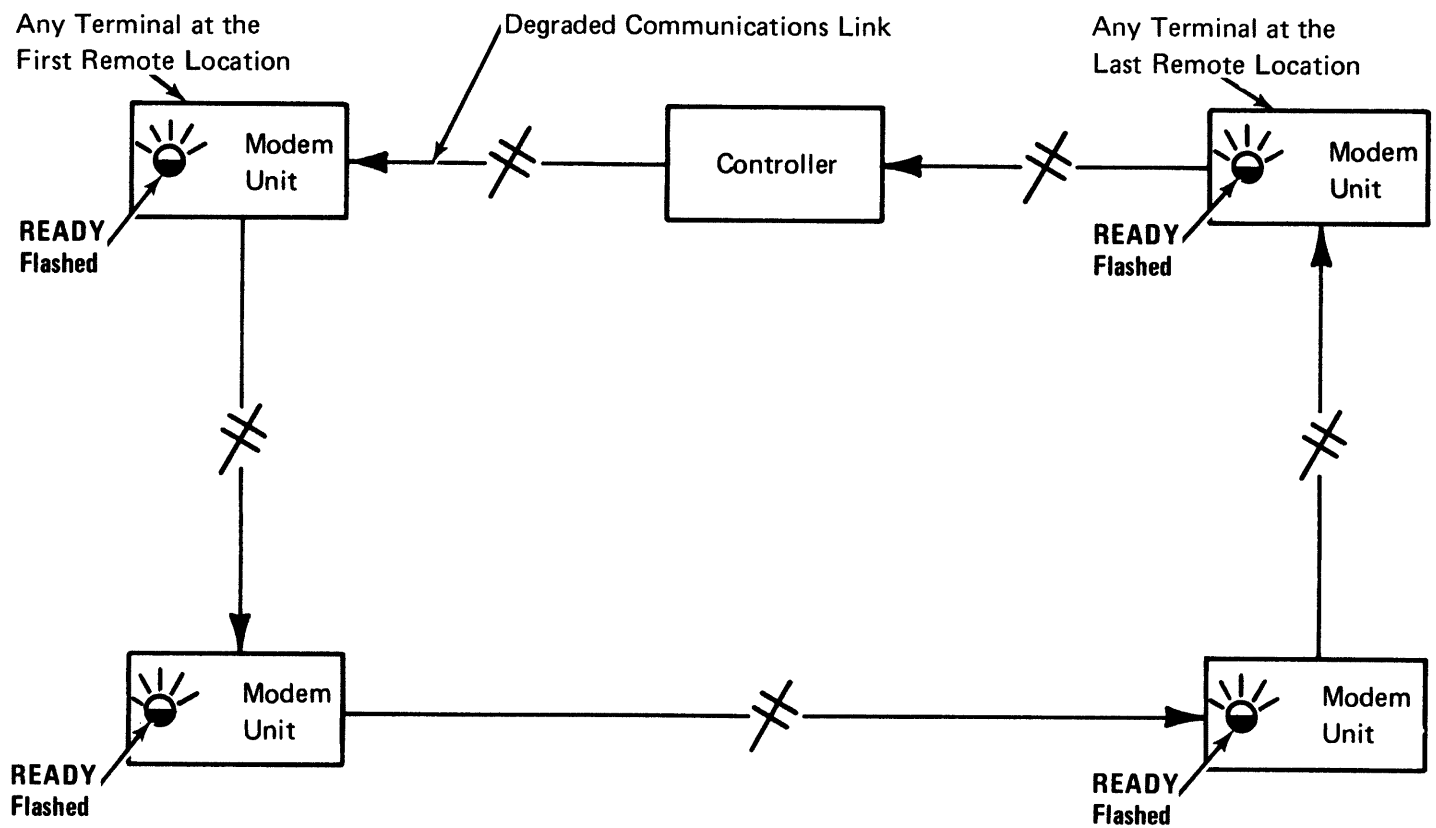
This procedure identifies a "degraded" communications link in external modem or integrated 1200-bps multi-location remote loop configurations. A degraded communications link is a link that operates normally most of the time but every now and then causes problems that are intermittent; that is, the problems come and go. Usually the problems are related to "noise" on the telephone line, which may show up in different ways. For example, while entering information at the keyboard all or part of the display may be erased and you have to enter the information again. Or, the passbook may be ejected from the printer before you have finished the transaction and you have to start over. A third example would be a hesitation in the displaying of data on the 3604. A fourth example would be when all the READY lights are on, but the terminals cannot be used. Usually intermittent problems do not occur often and are only a nuisance. But when they occur so often that they interfere greatly with normal operations, you may decide to identify the degraded link and have it fixed. See **1**.

- 01 Stop all operations on the external modem or integrated 1200-bps multi-location remote loop. *Do not enter an 040 1 command to stop the loop!* Contact the remote locations and tell them not to use the terminals on the remote loop but to keep power on all the terminals.
- 02 While the loop is running but all activity is stopped, have someone at each remote location watch the READY light on any terminal for about one minute to see if the READY light stays on or flashes every now and then (perhaps only once or twice). See **2**.
- 03 At the end of the one minute, contact the remote locations and ask them if the READY lights stayed on or flashed during that time. (If there were no flashes during that one minute, repeat the procedure but have them watch the READY lights for two minutes.) Write down their answers.
- 04 Refer to Figures 10, 11, and 12. Select the figure that shows the condition of the READY lights on the terminals as reported by the remote locations.
- 05 If there is an external modem, perform its test procedures and, if it fails, contact the SR for it. If it passes, call the telephone company and report the degraded telephone line.
  - End of procedure.

## Notes

- 1** For multi-location remote loops you, as the local control operator, must coordinate the actions of the remote control operators.
- 2** At remote subscriber locations, it is recommended that repair or service personnel from your institution be used for this purpose.

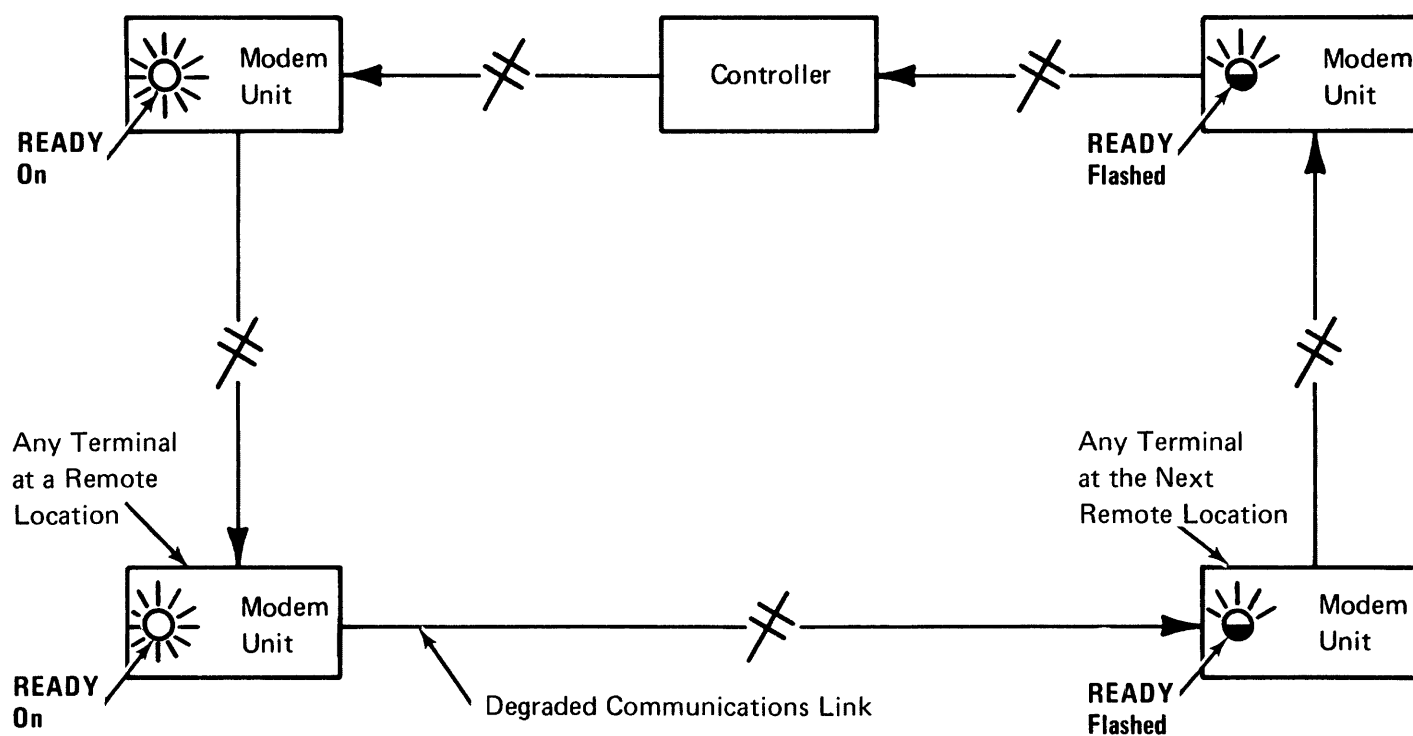




**Notes:**

- 1 The degraded communications link is the one connecting the controller and the first remote location.
- 2 The *READY* lights on the terminals after the degraded communications link will flash every now and then.
- 3 Refer to the *Remote Loop Location Directory* for information about the remote location and the physical order of the remote location on the remote loop.

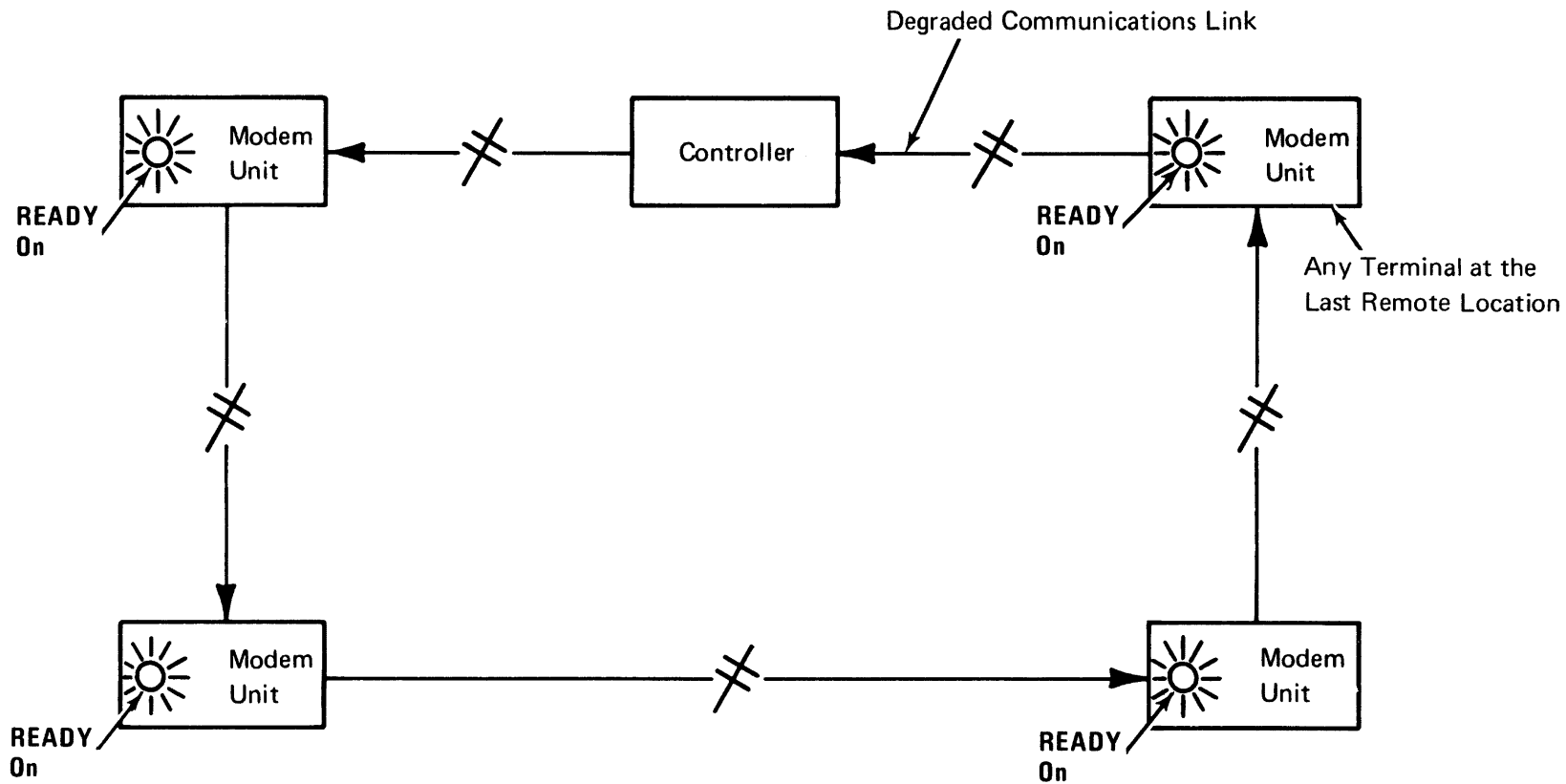
Figure 10. The *READY* light on the terminal at all remote locations flashed.



**Notes:**

- 1 The degraded communications link is the one connecting the last remote location whose READY light(s) is on and the first remote location whose READY light(s) flashed.
- 2 The READY lights on the terminals before the degraded communications link will be on. The READY lights on the terminals after the degraded communications link will flash every now and then.
- 3 Refer to the Remote Loop Location Directory for information about the remote locations and the physical order of the remote locations on the remote loop.

Figure 11. All READY lights at a remote location are on and all READY lights at the next remote location flashed.



**Notes:**

- 1 The degraded communications link is the one connecting the last remote location and the controller.
- 2 The READY lights on the terminals before the degraded communications link will be on.
- 3 Refer to the Remote Loop Location Directory for information about the remote location and the physical order of the remote location on the remote loop.

Figure 12. The READY lights at all locations are on.

C

2 See 1 .

When an integrated 600-bps remote loop fails, the problem could be caused by a failure in the controller or its modem (external or integrated) at the local location, in the modem and/or terminals at the remote location(s), or of the telephone lines connecting the location(s). Unlike most external modem or integrated 1200-bps remote loops, however, the 600-bps modem cannot be wrap-tested. See 2 .

01 Check that the phone connections from the modem unit are correct and secure. See 3 .

02 Log on the "control operator 3604" (see 4 ), and enter a 040 0 command to start all loops that are stopped.

03 Is the remote loop now working correctly?

N Y

- The problem has been corrected, the loop was stopped.
- End of procedure.

04 Wait about 2 minutes or until the CHECK light on the "control operator 3604" comes on, and then enter a 001 command to display the five most recent controller log messages. See 5 .

05 Refer to the 11 005 message format in the "Notes" column. See 6 . In the 11 005 message displayed for the failing loop, is the number in the Y position a 0?

Y N

- Fill out a Problem Report Sheet for the controller.
- Call the SR and report the failing controller; it is a remote loop problem.
- Notify the remote location(s) that the controller is failing.
- End of procedure.

06 Is the number in the Z position a 2 or a 3? See 6 .

Y N

- Fill out a Problem Report Sheet for the failing modem unit.
- Call the SR and report the failing modem unit.
- Notify the remote location(s) that the modem unit is failing.
- End of procedure.

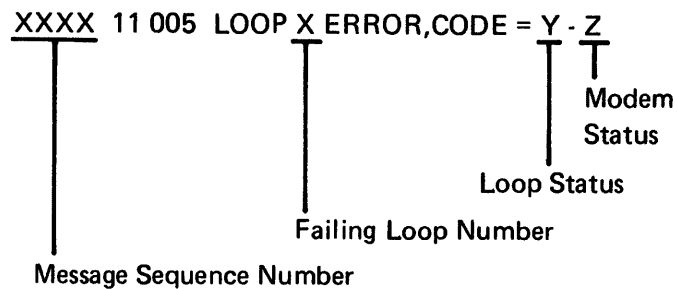
39  
AG

### Notes

- 1 This procedure is not used in the USA. It deals with a loop speed of 600 bps used in other countries.
- 2 For multi-location remote loops you, as the local control operator, must coordinate the actions of the remote control operators.
- 3 In these recovery procedures, a unit that can interface directly with telephone lines or a modem is called a "modem unit." The units in the 3600 system that can interface directly with telephone lines or a modem at 600 bps are: the 3604-2, -3, or -4 and any 3614 model. You can recognize a 3604 modem unit because it has a TEST UNIT/DSBL UNIT switch to the right of the keyboard. A 3614 modem unit has a TEST UNIT switch behind its rear door.
- 4 Press RE (reset) on the 3604 keyboard three times, then respond correctly. For a description of the logon procedure, see "Logon and Logoff."

5 The most recent message is displayed on the top line, the second most recent message is displayed on the second line, and so on.

6 Log message format:



If the log message indicated by these procedures is not displayed, it is possible the log message area is full and messages have been lost. To determine if the area is full, do a Write to Log command by entering 030 TEXT. If the area is not full, the message will be entered in the log; if the area is full, a 90012 message will be displayed.

- 01 Is the modem unit a 3614? See **1**.
- N Y
- 02 Have the remote control operator refer to the Problem Recovery Procedures in the *3614 Operator's Guide*, GA66-0001. See **2**.
- 03 On the 3604 modem unit at the remote location, have the remote control operator press TEST UNIT of the TEST UNIT/DSBL UNIT switch. Does the 1 light on the 3604 come on solid?
- Y N
- 04 Is a Loop Repeater installed on the loop at the remote location?
- N Y
- 05 Check to see if the Loop Repeater is failing by having the remote control operator:
- Unplug the Loop Repeater from the loop.
  - Plug a spare Loop Repeater into the loop.
  - Plug the power plug of the spare Loop Repeater into an outlet.
- 06 Have the remote control operator press TEST UNIT of the TEST UNIT/DSBL UNIT switch. Does the 1 light on the 3604 come on solid?
- N Y
- 07 Have the remote control operator replace the original Loop Repeater with a space.
- End of procedure.
- 08 Have the remote control operator replace the original Loop Repeater into the loop at the remote location and continue with step 09.
- 09 Have the remote control operator fill out a Problem Report Sheet for the remote location 3604 modem unit.
- Call the SR and report a remote loop problem; the remote location 3604 modem unit is failing.
  - Notify the remote location(s) that the 3604 remote location modem unit is failing.
  - End of procedure
- 10 Call the telephone company; it is a telephone line problem.
- Notify the remote location that there is a telephone line problem.
  - End of procedure.

- 1** In these recovery procedures, a unit that can interface directly with telephone lines or a modem is called a "modem unit." The units in the 3600 system that can interface directly with telephone lines or a modem at 600 bps are: the 3604-2, -3, or -4 and any 3614 model. You can recognize a 3604 modem unit because it has a TEST UNIT/DSBL UNIT switch to the right of the keyboard. A 3614 modem unit has a TEST UNIT switch behind its rear door.
- 2** For multi-location remote loops you, as the local control operator, must coordinate the actions of the remote control operators.

D

2 See 1 .

01 Log on the "control operator 3604." See 2 .

02 Enter a 001 command to display the five most recent controller log messages. See 3 .

03 Refer to the 11 006 message format in the "Notes" column to answer the following questions. (See "Display/Print Controller Log" for a discussion of this message.) See 4 .

04 Does A = 0?

N Y

05 The controller detected an error and performed a successful wrap test. Contact the host site and tell them the wrap test was successful but you have a host link failure. Follow their instructions.

06 Does A = 1?

N Y

07 Refer to the 11 006 message format in the "Notes" column to answer the following questions. See 4 .

08 Does B = 9?

N Y

- Fill out a Problem Report Sheet for the controller.
- Call the SR and report the failing controller; it is a host link failure.
- End of procedure.

09 B = D. The controller performed the automatic wrap test of the modem and it failed.

- Call the SR for the modem.
- End of procedure.

10 Does A = 2?

N Y

11 The controller was idle, and the control operator requested the link to stop by entering a stop link command. To reestablish the link, enter a start link command.

41  
AH

## Notes

**1** When the host link fails, the problem could be caused by a failure in the controller or its modem (external or integrated) at the local location, in the modem at the host site, or of the telephone lines connecting the two. To help you determine if the problem is at your local location, the controller automatically checks itself and the modem (integrated or some external models) if programmed to do so. This check is called a "wrap test". If the wrap test is successful, it means that the controller and its tested modem are OK and the problem is not at your local location. The results of this wrap test are recorded in a 11 006 message in the controller log. To display the controller log, enter a 001 command.

**2** Press RE (reset) on the 3604 keyboard three times, then respond correctly. For a description of the logon procedure, see "Logon and Logoff."

**3** The most recent message is displayed on the top line, the second most recent message is displayed on the second line, and so on.

**4** Log message format:

```

XXXXXXXX 11 006 AXXXXB.....

```

All messages may not have this data.

Message Sequence Number

If the log message indicated by these procedures is not displayed, it is possible the log message area is full and messages have been lost. To determine if the area is full, do a Write to Log command by entering 030 TEXT. If the area is not full, the message will be entered in the log; if the area is full, a 90012 message will be displayed.

AH  
40

01 Does A = 3? See **1** .

N Y

02 A message was received in error. The 28 characters following the "3" are for programming information. Contact the host site and tell them:

- You have a host link failure.
- In the 11 006 message, A = 3.
- Follow their instructions.

03 If A equals anything other than 0, 1, 2, or 3, that message was written by your institution's application program. Follow your institution's procedures.

- End of procedure.

### Notes

**1** Log message format:

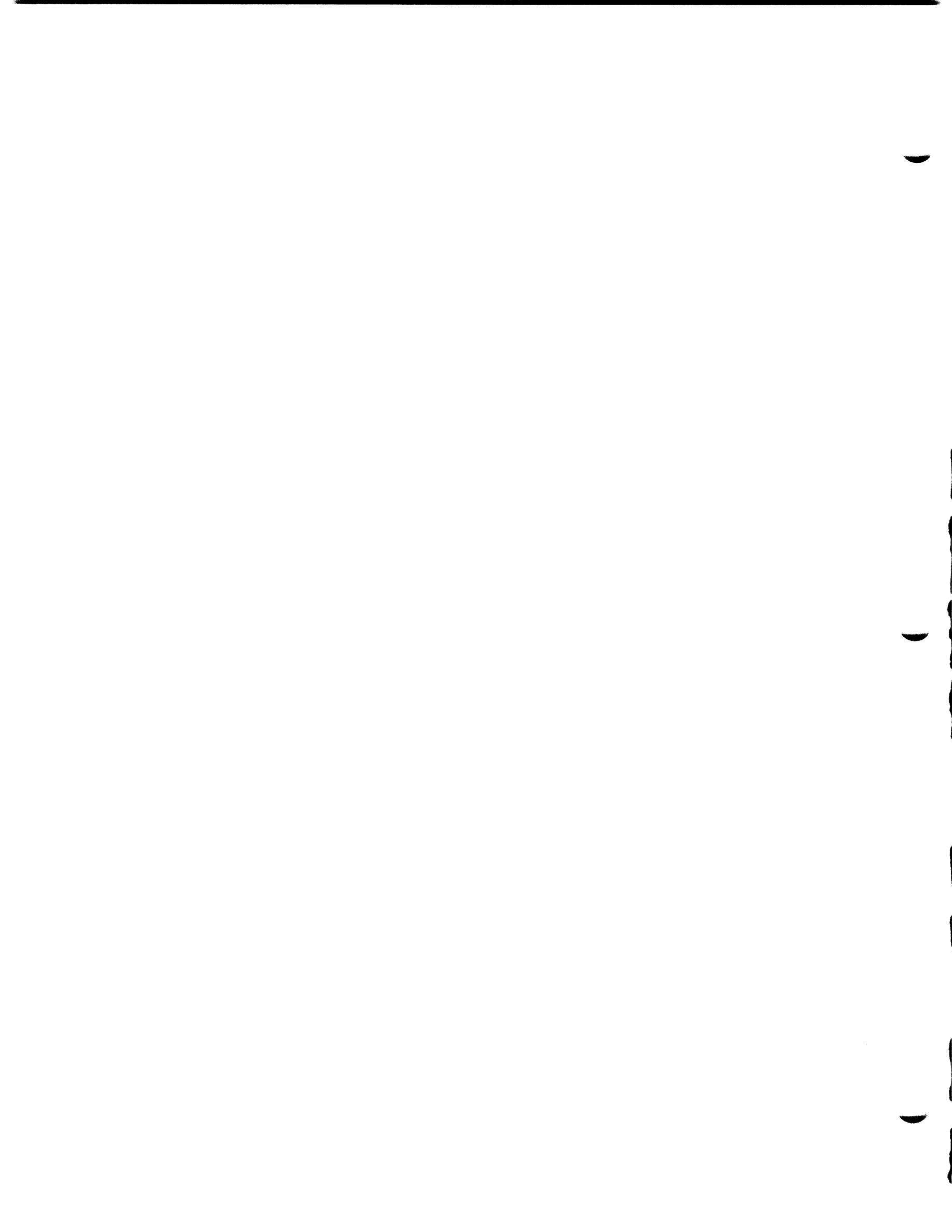
XXXX 11 006 A<sup>1 2 3 4 5</sup>XXXB.....]

↖ All messages may not have this data.

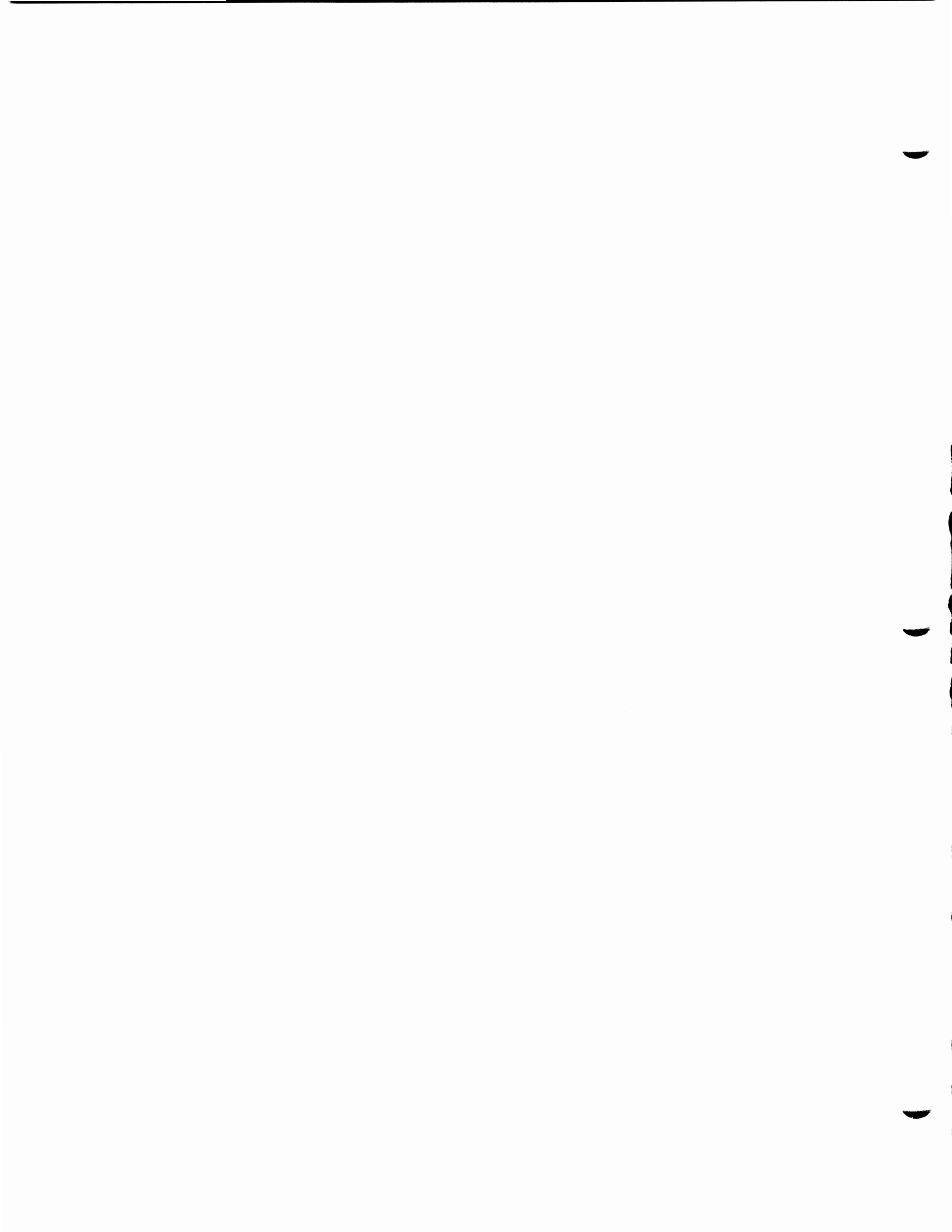
Message Sequence Number

If the log message indicated by these procedures is not displayed, it is possible the log message area is full and messages have been lost. To determine if the area is full, do a Write to Log command by entering 030 TEXT. If the area is not full, the message will be entered in the log; if the area is full, a 90012 message will be displayed.





This page precedes the Problem Recovery, External Modem/1200-BPS Remote Loop Procedures page 1.



## REMOTE LOCATION, EXTERNAL MODEM OR INTEGRATED 1200-BPS REMOTE LOOP PROCEDURES

These procedures should be located at every remote location that has a remote control operator and is on an external modem or integrated 1200-bps remote loop. The procedures lead you, the remote control operator, through actions that determine the nature and location of the problem. If the problem is with your modem unit or the telephone lines, you are directed to contact the local control operator for instructions. If the problem is with a terminal other than the modem unit or with a loop cable connecting terminals, the procedures isolate the problem and direct your recovery actions.

In these recovery procedures, the READY light on the terminals and the SYNC light on the 3603s play an important role, and many times you are asked to check the condition of these lights.

In the Normal mode, there are only three possible conditions:

1. On (the light is on all the time).
2. Off (the light is off all the time).
3. Flashing (the light is blinking on and off).

In the Wrap Test mode, there are only two possible conditions:

1. On (the light is on all the time).
2. Off (the light is off all the time).

**Note:** *In the Wrap Test mode, if the SYNC light of a 3603 or the READY light of a modem unit should exhibit an occasional flicker, its condition should be considered "on."*

For local location, call \_\_\_\_\_.

For service, call \_\_\_\_\_.

START

Notes

When an external modem or integrated 1200-bps remote loop fails, the problem could be caused by a failure in the controller or its modem (external or integrated) at the local location, or of the telephone lines connecting the locations. To check out your remote location, the following procedures have you do a "wrap test." On a wrap test, your remote subloop is disconnected from the telephone lines. The modem unit generates a test signal that goes out on the subloop, through each terminal, and returns (wraps) to the modem unit. See 1. If the READY light on the modem unit comes on, the wrap test was successful, and the modem unit and the cables connecting the terminals are OK. If the READY light stays off, the wrap test was unsuccessful, and the problem is within your subloop and not with the telephone lines or the local location. See 2.

01 Is the READY (or SYNC) light on the modem unit on?

Y N

02 Set or press the appropriate switch:

- On a 3603, set the Wrap Test toggle switch to WRAP UNIT/LOOP and then to WRAP UNIT. See 3.
- On a 3604, press TEST UNIT of the TEST UNIT/DSBL UNIT switch.
- On a 3606-2, press TEST of the blue DSBL/TEST switch.
- On a 3608-2, press TEST UNIT of the blue DSBL UNIT/TEST UNIT switch.
- On a 3614, press the TEST UNIT switch to the TEST UNIT position.

03 Was the wrap test successful?

N Y

04 Check that the phone connections are correct and secure.

05 If the modem unit is a 3603-2, perform the test procedures of the external modem and if it fails, contact the SR for it. If it passes, the problem is not at your location.

06 Call your local location and tell the control operator the conditions of the READY lights on all the terminals on the subloop when the modem unit is in the normal mode. See 4. Follow the operator's instructions.

1 In these recovery procedures, a unit that can interface directly with telephone lines or a modem is called a "modem unit." The units in the 3600 system that can interface directly with telephone lines or a modem are: the 3603; the 3604-2, -3, or -4; the 3606-2; the 3608-2; and any 3614 model. You can recognize a 3604 modem unit because it has a TEST UNIT/DSBL UNIT switch to the right of the keyboard. A 3606-2 modem unit has a DSBL/TEST switch on its right side. A 3608-2 modem unit has a DSBL UNIT/TEST UNIT switch on its front face. A 3614 modem unit has a TEST UNIT switch behind its rear door. The 3603 modem unit is a small wall-mounted unit that has a single toggle switch and SYNC light (the 3603-1 also has a rotary selector switch) on its front panel.

2 The local location is the location that has the controller to which your remote subloop is attached.

3 CAUTION: To change the switch setting of the 3603 Wrap Test toggle switch, it is necessary to pull outward on the toggle handle to unlock it before attempting to reset it. This built-in locking feature prevents the setting of the switch from being accidentally altered.

4 NORMAL mode for the . . .
• 3603 modem unit is when the Wrap Test toggle switch is set to NORMAL.
• 3604 modem unit is when the TEST UNIT/DSBL UNIT switch is in the normal position.
• 3606-2, modem unit is when the blue DSBL/TEST switch is in the normal position.
• 3608-2, modem unit is when the blue DSBL UNIT/TEST UNIT switch is in the normal position.
• 3614 modem unit is when the TEST UNIT switch is in the normal position.

3
IAJ

AJ

2

01 Is the remote subloop at this location attached to a 3603?

N Y

02 Was the WRAP UNIT wrap test successful?

Y N

03 The 3603 is failing.

- Notify the local control operator of the failing 3603.
- Replace the 3603 with a spare.
- End of procedure.

04 If the modem unit is a 3603-2, perform the test procedures of the external modem and if it fails, contact the SR for it. If it passes, continue with step 07.

05 Is the modem unit at this location a 3606-2 or a 3608-2?

N Y

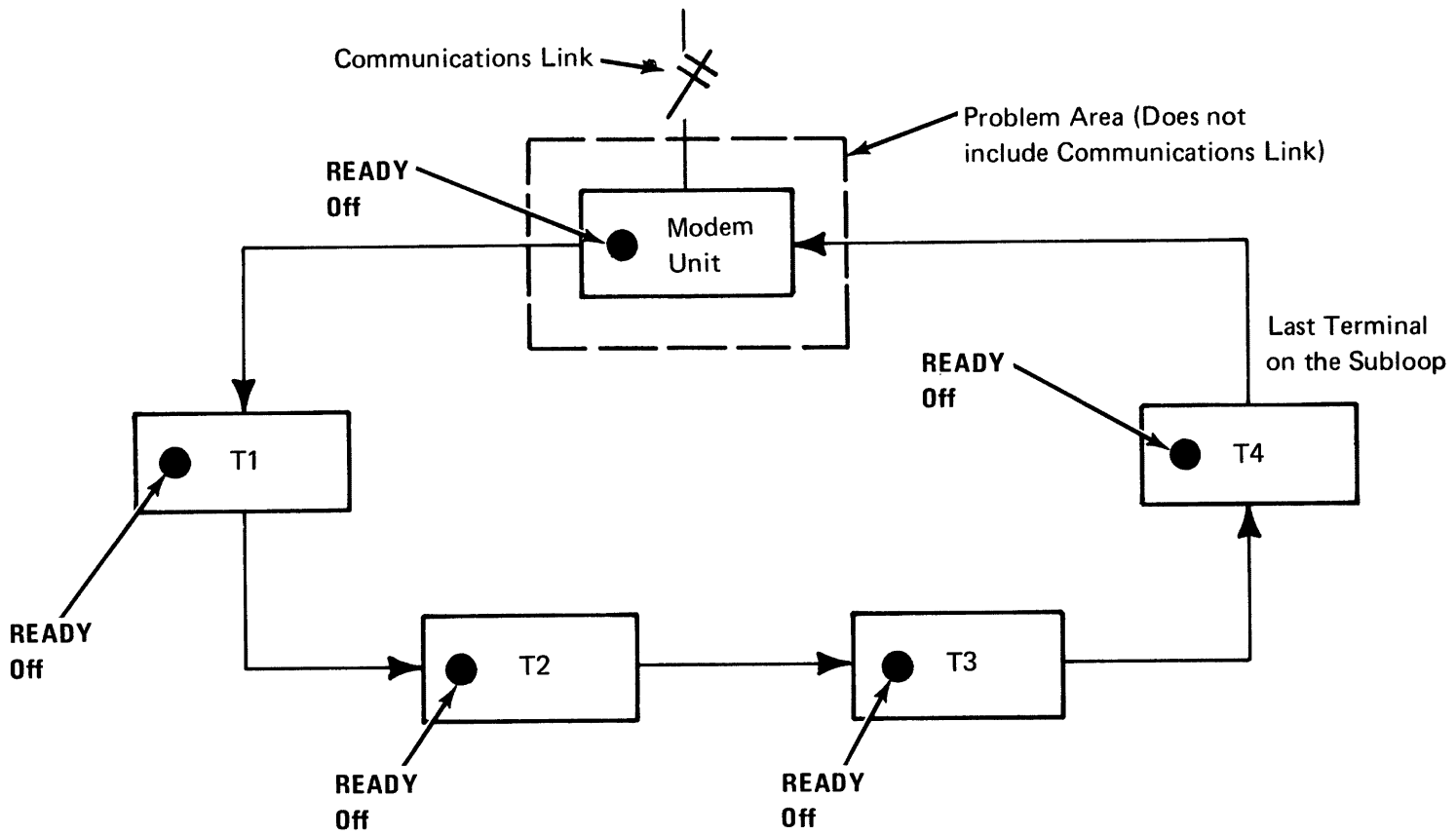
06 The 3606-2 or 3608-2 modem unit is failing.

- Notify the local control operator of the failing modem unit.
- Replace the 3606-2 or 3608-2 with a spare.
- End of procedure.

07 Refer to Figures 1, 2, and 3. Select the figure that shows the condition of the READY lights on the terminals when the modem unit is in the normal mode. See **1**. Go to the page referenced and follow the procedure on that page.

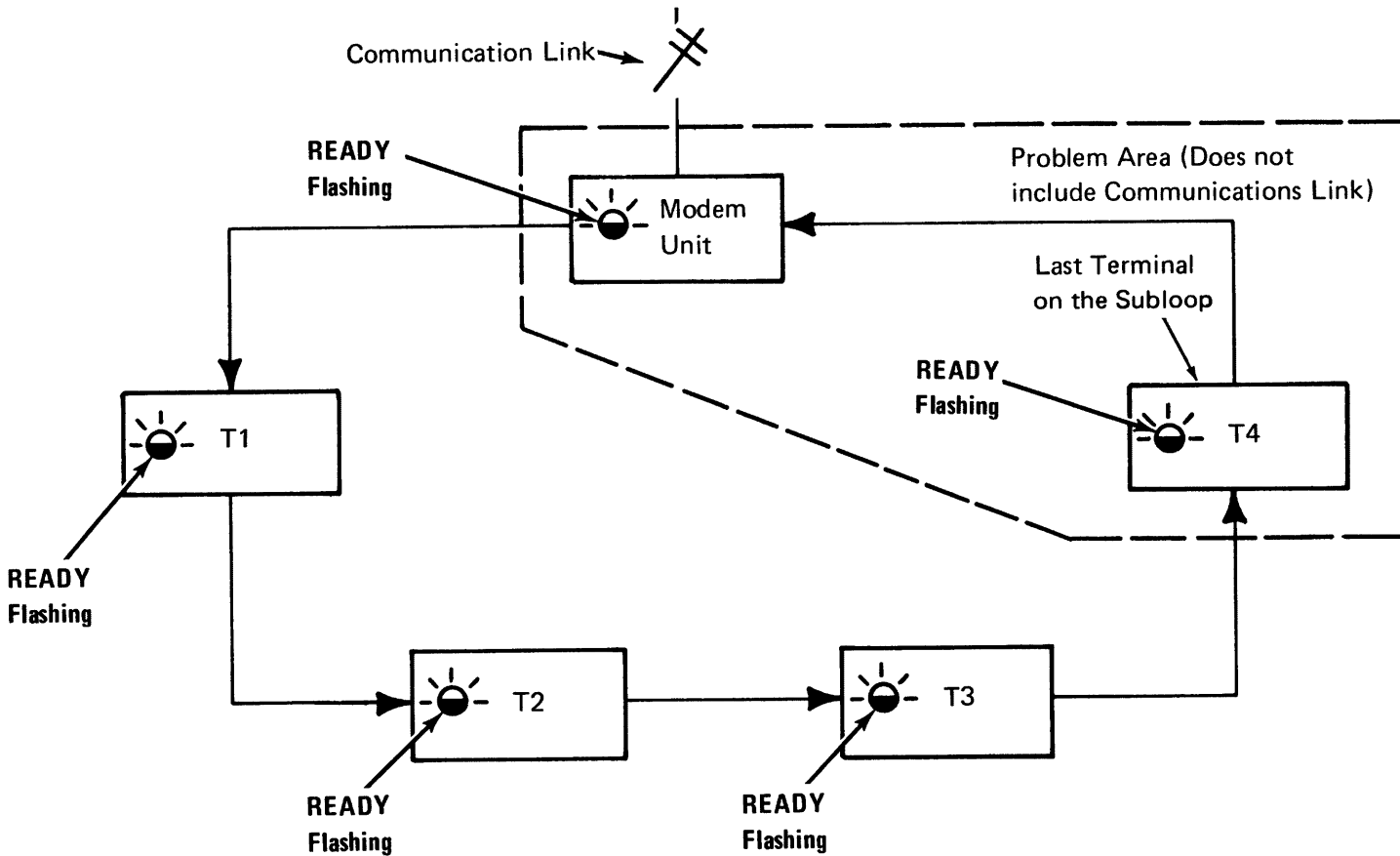
## Notes

- 1** NORMAL mode for the . . .
  - 3603 modem unit is when the Wrap Test toggle switch is set to NORMAL.
  - 3604 modem unit is when the TEST UNIT/DSBL UNIT switch is in the normal position.
  - 3606-2, modem unit is when the blue DSBL/TEST switch is in the normal position.
  - 3608-2, modem unit is when the blue DSBL UNIT/TEST UNIT switch is in the normal position.
  - 3614 modem unit is when the TEST UNIT switch is in the normal position.



**Note:** Refer to the Remote Loop Description Sheet for the failing subloop to make sure you know which terminals are on the subloop and the physical order of the terminals on the subloop.

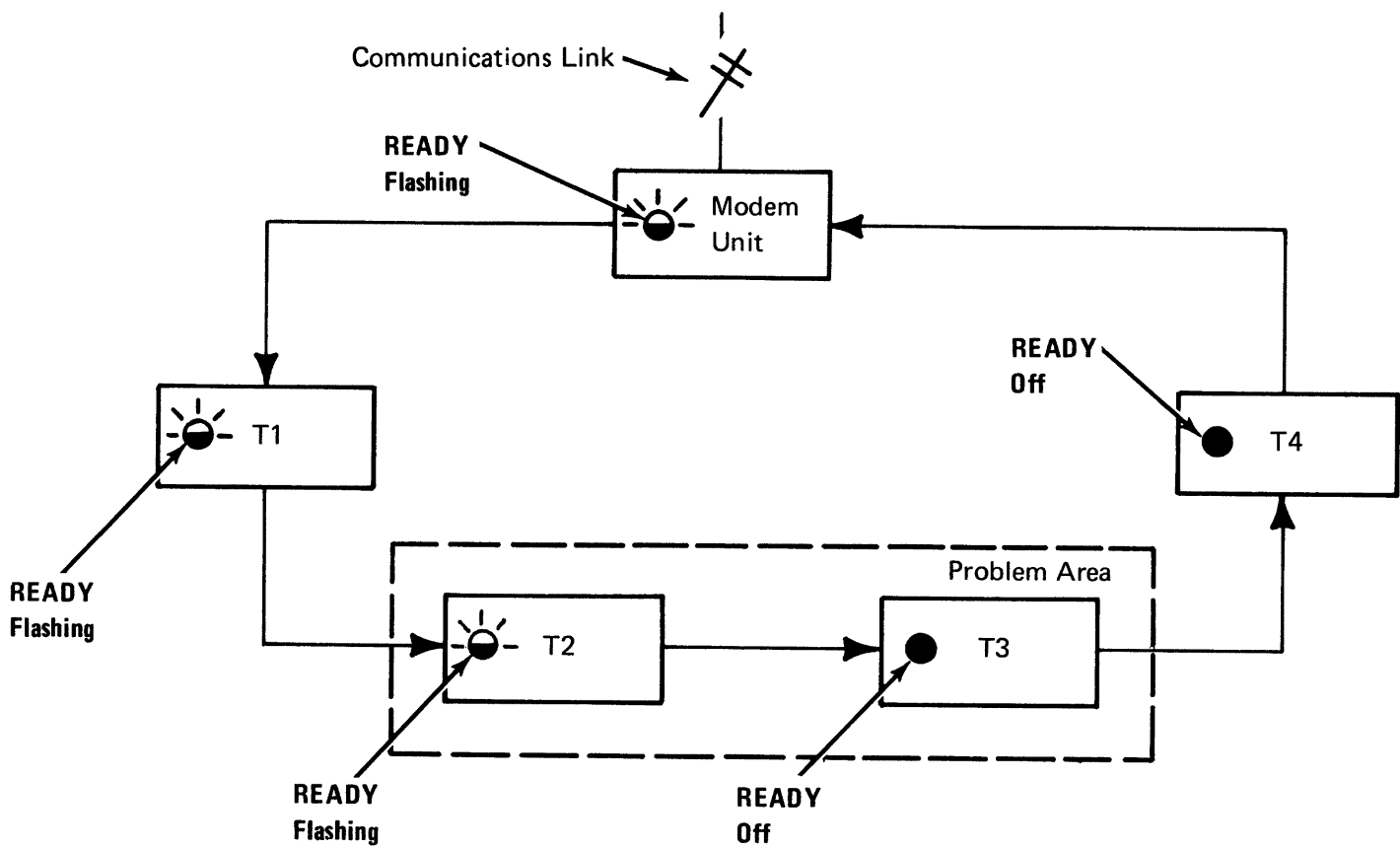
**Figure 1.** All READY lights are off. Go to AK on page 7.



**Note:** Refer to the Remote Loop Description Sheet for the failing subloop to make sure you know which terminals are on the subloop and the physical order of the terminals on the subloop.

**Figure 2.** All READY lights are flashing. Go to AL on page 8.





**Note:** Refer to the Remote Loop Description Sheet for the failing subloop to make sure you know which terminals are on the subloop and the physical order of the terminals on the subloop.

**Figure 3.** Some READY lights are flashing and some are off. Go to AM on page 12.

AI  
2  
|

- 01 If the modem unit is a 3606-2 or a 3608-2, go to step 07; if not continue with step 02.
- 02 Check that the 3603 Wrap Test toggle switch, the TEST UNIT/DSBL UNIT switch on the 3604 modem unit, or the TEST UNIT switch on the 3614 modem unit is in the normal position. See **1**.
- 03 Check the settings of the address switches on all the terminals on the subloop (for the 3614s, skip this step). See **2**.
- 04 Check that the speed switches on all the terminals on the subloop are set to the correct loop speed (for 3614s, skip this step). See **2**.
- 05 Is the subloop operating correctly but one terminal is failing?

N Y  
|

- 06 At the failing terminal, do the following checks. After each check, see if the READY light came on. If so, the step you just did corrected the problem. If not, go to the next check.
- Check that the ON/OFF switch is on (press ON).
  - Check that the power plug is in all the way in the outlet.
  - Check that there is power at the outlet. See **3**.
  - If the terminal is a 3614, skip the rest of the checks and refer to the Problem Recovery Procedures in the *3614 Operator's Guide*, GA66-0001.
  - If the terminal is a 3608, check that there is no forms jam or obstruction in the forms slot. If the terminal is a printer, check that there are forms in the printer and that they are loaded properly.
  - Check that the covers are closed properly.
  - Turn off the terminal and then turn it back on. (Skip this step if the terminal is a 3604 modem unit.) See **4**.
- If the checks did not correct the problem, go to steps 07 or 08 on this page.
- 07 If the terminal is not a 3606-2 or 3608-2:
- Replace the failing terminal with a spare.
  - End of procedure.
- 08 If the terminal is a 3606-2 or 3608-2:
- Fill out a Problem Report Sheet for the failing terminal.
  - Call the SR and report the failing terminal.
  - End of procedure.
- 09 If the modem unit is a 3603-2, perform the test procedures of the external modem and if it fails, contact the SR for it. If it passes, fill out a Problem Report Sheet for the failing subloop.
- Call your local location and tell the control operator that the remote subloop is not operating correctly. Follow the control operator's instructions.

## Notes

- 1** In these recovery procedures, a unit that can interface directly with telephone lines or a modem is called a "modem unit." The units in the 3600 system that can interface directly with telephone lines or a modem are: the 3603; the 3604-2, -3, or -4; the 3606-2; the 3608-2; and any 3614 model. You can recognize a 3604 modem unit because it has a TEST UNIT/DSBL UNIT switch to the right of the keyboard. A 3606-2 modem unit has a DSBL/TEST switch on its right side. A 3608-2 modem unit has a DSBL UNIT/TEST UNIT switch on its front face. A 3614 modem unit has a TEST UNIT switch behind its rear door. The 3603 modem unit is a small wall-mounted unit that has a single toggle switch and SYNC light (the 3603-1 also has a rotary selector switch) on its front panel.
- 2** The loop speed and address switches are located in different places for different terminals. On the 3604, they are located on the bottom of the terminal; to get at them, you must tip up the 3604. *Have someone help you tip it up.* On the 3606 and 3608, the loop speed, terminal address, and subaddress switches are located behind the red display filter. (The 3606-2 and 3608-2 do not have any loop speed switches.) On the 3610, 3611, 3612, and 3618 printers, the switches are located inside the printer. For the location of the switches on these terminals and for information on the loop speed and address switch settings, see "Loop Speed and Address Switches" under "Installation Details." The 3614 does not have loop speed and address switches; the speed and address are fixed.
- CAUTION:** The loop speed and address setting should be changed only by authorized personnel under the direction of your institution's management.
- 3** If a lamp or any electrical appliance plugged into the outlet works, the outlet has power. If the outlet does not have power, notify the person responsible for building maintenance.
- 4** Turning the terminal off and then on may reset other terminals on the subloop. Therefore, try to verify that the other terminals on the loop are not being used before doing this check. If this is not possible keep this activity to a minimum.

AK

4

01 Go to the modem unit (see **1**) and do the steps indicated:

- 1) Steps a–e for the 3604, or
- 2) Steps a–d for the 3614.

After each step, see if the READY light came on. If so, the step you just did corrected the problem. If not, go to the next check.

- a. Check that the power plug is all the way in the outlet.
- b. Check that there is power at the outlet. See **2**.
- c. Check that the phone connections are correct and secure.
- d. Check that the ON/OFF switch is on (press ON).
- e. Check that the speed switches are set to loop speed. See **3**.

02 Are there more terminals on the subloop beside the modem unit? See **4**.

Y N

03 The modem unit is the failing terminal.

- If the modem unit is a 3614, refer to the Problem Recovery Procedures in the *3614 Operator's Guide*, GA66-0001.
- Fill out a Problem Report Sheet for the modem unit.
- Call your local location and tell the control operator that your modem unit and remote location are failing. Follow the control operator's instructions. See **5**.

04 Press DSBL UNIT of the TEST UNIT/DSBL UNIT switch on the 3604 modem unit (on the 3614 modem unit press the DSBL UNIT switch to DSBL UNIT).

05 Turn on the other terminals. If the READY lights on the other terminals come on, leave the modem unit on and the switch in DSBL UNIT.

06 The modem unit is the failing terminal.

- If the modem unit is a 3614, refer to the Problem Recovery Procedures in the *3614 Operator's Guide*, GA66-0001.
- Fill out a Problem Report Sheet for the modem unit.
- Call your local location and tell the control operator that your modem unit and remote location are failing. Follow the control operator's instructions. See **5**.

## Notes

**1** In these recovery procedures, a unit that can interface directly with telephone lines or a modem is called a "modem unit." The units in the 3600 system that can interface directly with telephone lines or a modem are: the 3603; the 3604-2, -3, or -4; the 3606-2; the 3608-2; and any 3614 model. You can recognize a 3604 modem unit because it has a TEST UNIT/DSBL UNIT switch to the right of the keyboard. A 3606-2 modem unit has a DSBL/TEST switch on its right side. A 3608-2 modem unit has a DSBL UNIT/TEST UNIT switch on its front face. A 3614 modem unit has a TEST UNIT switch behind its rear door. The 3603 modem unit is a small wall-mounted unit that has a single toggle switch and SYNC light (the 3603-1 also has a rotary selector switch) on its front panel.

**2** If a lamp or any electrical appliance plugged into the outlet works, the outlet has power. If the outlet does not have power, notify the person responsible for building maintenance.

**3** The loop speed and address switches are located in different places for different terminals. On the 3604, they are located on the bottom of the terminal; to get at them, you must tip up the 3604. *Have someone help you tip it up.* On the 3606 and 3608, the loop speed, terminal address, and subaddress switches are located behind the red display filter. (The 3606-2 and the 3608-2 do not have any loop speed switches.) On the 3610, 3611, 3612, and 3618 printers, the switches are located inside the printer. For the location of the switches on these terminals and for information on the loop speed and address switch settings, see "Loop Speed and Address Switches" under "Installation Details." The 3614 does not have loop speed and address switches; the speed and address are fixed.

**CAUTION:** The loop speed and address setting should be changed only by authorized personnel under the direction of your institution's management.

**4** You must be able to identify the terminals that are attached to the failing subloop. And because you may have terminals attached to other loops in your location, or you may have loops attached to different controllers, you can avoid confusion by always using the Remote Loop Description Sheet to identify the terminals on the failing subloop.

**5** The local location, is the location that has the controller to which your remote subloop is attached.

AL

4

01 Check that the speed switches on all the terminals are set to the loop speed. (For a 3606-2, a 3608-2, or a 3614, skip this step.) See **1**.

9

AN

## Notes

- 1** The loop speed and address switches are located in different places for different terminals. On the 3604, they are located on the bottom of the terminal; to get at them, you must tip up the 3604. *Have someone help you tip it up.* On the 3606 and 3608, the loop speed, terminal address, and subaddress switches are located behind the red display filter. (The 3606-2 and 3608-2 do not have any loop speed switches.) On the 3610, 3611, 3612, and 3618 printers, the switches are located inside the printer. For the location of the switches on these terminals and for information on the loop speed and address switch settings, see "Loop Speed and Address Switches" under "Installation Details." The 3614 does not have loop speed and address switches; the speed and address are fixed.

**CAUTION:** The loop speed and address setting should be changed only by authorized personnel under the direction of your institution's management.

AN

8

01 On the modem unit, check that its phone connections are correct and secure. See **1** .

02 Are there other terminals on the loop in addition to the modem unit? See **2** .

Y N

03 On the modem unit, pull out the loop cables and plug them in again. (They may be loose.) See **3** .

04 If the above step did not correct the problem, the modem unit loop cable may be failing. Try a spare loop cable. If this does not correct the problem:

- If the modem unit is a 3614, refer to the Problem Recovery Procedures in the *3614 Operator's Guide*, GA66-0001.
- Fill out a Problem Report Sheet for the modem unit.
- Call your local location and tell the control operator that your modem unit and remote location are failing. Follow the control operator's instructions. See **4** .

05 If the modem unit is a 3603, go to step 01 on page 10.

06 Press DSBL UNIT of the TEST UNIT/DSBL UNIT switch on the 3604 modem unit. (On the 3614 modem unit, press the DSBL UNIT switch to DSBL UNIT.)

07 Check the READY lights on all the other terminals on the subloop. If the READY lights *do not* come on, place the switch in the normal position and go to the next step. If the READY lights *do* come on, the modem unit is failing. Leave the switch in DSBL UNIT and:

- If the modem unit is a 3614, refer to the Problem Recovery Procedures in the *3614 Operator's Guide*, GA66-0001.
- Fill out a Problem Report Sheet for the failing modem unit.
- Call your local location and tell the control operator that your modem unit and remote location are failing. Follow the control operator's instructions. See **4** .

10

AO

## Notes

- 1** In these recovery procedures, a unit that can interface directly with telephone lines or a modem is called a "modem unit." The units in the 3600 system that can interface directly with telephone lines or a modem are: the 3603; the 3604-2, -3, or -4; the 3606-2; the 3608-2; and any 3614 model. You can recognize a 3604 modem unit because it has a TEST UNIT/DSBL UNIT switch to the right of the keyboard. A 3606-2 modem unit has a DSBL/TEST switch on its right side. A 3608-2 modem unit has a DSBL UNIT/TEST UNIT switch on its front face. A 3614 modem unit has a TEST UNIT switch behind its rear door. The 3603 modem unit is a small wall-mounted unit that has a single toggle switch and SYNC light (the 3603-1 also has a rotary selector switch) on its front panel.
- 2** You must be able to identify the terminals that are attached to the failing subloop. And because you may have terminals attached to other loops in your location, or you may have loops attached to different controllers, you can avoid confusion by always using the Remote Loop Description Sheet to identify the terminals on the failing subloop.
- 3** To pull out the loop cables, all of the terminals except the 3606-1, 3608-1, 3614, and 3618 must be tipped up. *Have a second person help you tip up the terminal.* The 3606-1 and 3608-1 can be disconnected from the loop by pulling the connector, on the end of the 6 foot (1.8 m) signal cable attached to the unit, straight out from the loop port. To get at the loop cables on a 3614, open its rear door. On the 3618, face the rear of the printer and reach under the right rear corner. On all terminals, the cables are easily removed by grasping the plugs and pulling straight out.  
  
**CAUTION:** Cables should be removed only by authorized personnel under the direction of your institution's management. If your institution prohibits removing the cables, call your service representative for assistance.
- 4** The local location is the location that has the controller to which your remote subloop is attached.

- 01 Go to the *last terminal on the subloop* (T4 in Figure 2) and perform steps a–d below. After each step, check the READY lights on the other terminals on the subloop. If the READY lights come on, the step you just did corrected or bypassed the problem.
- a. If terminal T4 is a 3606-1 or 3608-1, unplug the terminal's signal cable from the loop port and plug it in again. If terminal T4 is not a 3606-1 or 3608-1, pull out the loop cables from the terminal and plug them in again. The connectors may not have been fully seated. See **1**.
  - b. If step a did not correct the problem, turn off terminal T4. [If T4 is a 3614, **DON'T TURN IT OFF**, but set its DSBL UNIT switch to DSBL UNIT position (up position).] If the READY lights on the other terminals on the subloop *do not* come on, go to step c. If the READY lights *do* come on, terminal T4 is failing. Leave T4 turned off (or the switch in DSBL UNIT) and:
    - If T4 is a 3606-1 or 3608-1, replace the terminal with a spare.
    - End of procedure.
    - If T4 is a 3614, refer to the Problem Recovery Procedures in the *3614 Operator's Guide*, GA66-0001.
    - Fill out a Problem Report Sheet for the failing terminal.
    - Call the SR and report the failing terminal; tell the SR to come to your remote location.
    - End of procedure.
  - c. If T4 is a 3606-1 or 3608-1, unplug it from the loop port. If T4 is not a 3606-1 or 3608-1, pull the loop cables out of the unit and plug them together. If the READY lights on the other terminals on the subloop do not come on, plug the terminal back into the loop, and go to the next step. If the READY lights do come on, terminal T4 is failing. Leave the terminal unplugged from the subloop and go to step 07 or 08 on page 11.
  - d. If step c did not correct the problem, continue with step 01 on page 11.

## Notes

- 1** To pull out the loop cables, all the terminals except the 3606-1, 3608-1, 3614, and 3618 must be tipped up. *Have a second person help you tip up the terminal.* The 3606-1 and 3608-1 can be disconnected from the loop by pulling the connector, on the end of the 6-foot (1.8 m) signal cable attached to the unit, straight out from the loop port. To get at the loop cables on a 3614, open its rear door. On the 3618, face the rear of the printer and reach under the right rear corner. On all terminals, the cables are easily removed by grasping the plugs and pulling straight out.

**CAUTION:** Cables should be removed only by authorized personnel under the direction of your institution's management. If your institution prohibits removing the cables, call your service representative for assistance.

AP  
10

01 Is a Loop Repeater installed on the loop at this remote location between terminal T4 and the modem unit?

N Y

02 Check to see if the Loop Repeater is failing by:

- Unplugging the Loop Repeater from the loop.
- Plugging a spare Loop Repeater into the loop.
- Plugging the power plug of the spare Loop Repeater into an outlet.

03 Did the READY lights on the terminals on the subloop come on?

N Y

04 Replace the original Loop Repeater with a spare.

- End of procedure.

05 On the modem unit, pull out the loop cables and plug them in again. (They may be loose.) See **1**.

06 If the above step did not correct the problem, the modem unit loop cable may be failing. Try a spare loop cable. If this does not correct the problem:

- If the modem unit is a 3614, refer to the Problem Recovery Procedures in the *3614 Operator's Guide*, GA66-0001.
- Fill out a Problem Report Sheet for the modem unit.
- Call your local location and tell the control operator that your modem unit and remote location are failing. Follow the control operator's instructions. See **2**.

07 If terminal T4 is a 3606-1 or 3608-1:

- Replace the failing terminal with a spare.
- End of procedure.

08 If terminal T4 is a 3614, refer to the Problem Recovery Procedures in the *3614 Operator's Guide*, GA66-0001.

- Fill out a Problem Report Sheet for the failing terminal.
- Call the SR and report the failing terminal.
- End of procedure.

## Notes

- 1** To pull out the loop cables, all the terminals except the 3606-1, 3608-1, 3614, and 3618 must be tipped up. *Have a second person help you tip up the terminal.* The 3606-1 and 3608-1 can be disconnected from the loop by pulling the connector, on the end of the 6-foot (1.8 m) signal cable attached to the unit, straight out from the loop port. To get at the loop cables on a 3614, open its rear door. On the 3618, face the rear of the printer and reach under the right rear corner. On all terminals, the cables are easily removed by grasping the plugs and pulling straight out.

**CAUTION:** Cables should be removed only by authorized personnel under the direction of your institution's management. If your institution prohibits removing the cables, call your service representative for assistance.

- 2** The local location is the location that has the controller to which your remote subloop is attached.



- 01 Turn on all terminals on the subloop.
- 02 On the modem unit, check that the phone connections are correct and secure. See **1**.
- 03 Go to the last terminal on the subloop whose READY light is flashing (T2 in Figure 3) and continue with step 04 on this page.
- 04 At this terminal perform steps a–d below. After each step, check if the READY lights on the other terminals on the subloop come on. If the READY lights come on, the step you just did corrected or bypassed the problem:
- Check that the speed switches on this terminal are set to the loop speed. (If this terminal is a 3614, skip this step.) See **2**.
  - If step a did not correct the problem, and this terminal is a 3606-1 or 3608-1, unplug the terminal's signal cable from the loop port and plug it in again. If this terminal is not a 3606-1 or 3608-1, pull out the loop cables from the terminal and plug them in again. The connectors may not have been fully seated. See **3**.
  - If step b did not correct the problem, turn off this terminal unless it is a 3614. If this terminal is a 3614, **DON'T TURN IT OFF**, but set its DSBL UNIT switch to the DSBL UNIT position (up position). If the READY lights on the other terminals on the subloop *do not* come on, turn this terminal back on and go to step d. If the READY lights *do* come on, this terminal is failing. Leave this terminal turned off (or the switch in DSBL UNIT) and:
    - If this terminal is a 3606-1 or 3608-1, replace the terminal with a spare.
    - End of procedure.
- If this terminal is a 3614, refer to the Problem Recovery Procedures in the *3614 Operator's Guide*, GA66-0001.
  - Fill out a Problem Report Sheet for the failing terminal.
  - Call the SR and report the failing terminal; tell the SR to come to your remote location.
  - End of procedure.

- 1** In these recovery procedures, a unit that can interface directly with telephone lines or a modem is called a "modem unit." The units in the 3600 system that can interface directly with telephone lines or a modem are: the 3603; the 3604-2, -3, or -4; the 3606-2; the 3608-2; and any 3614 model. You can recognize a 3604 modem unit because it has a TEST UNIT/DSBL UNIT switch to the right of the keyboard. A 3606-2 modem unit has a DSBL/TEST switch on its right side. A 3608-2 modem unit has a DSBL UNIT/TEST UNIT switch on its front face. A 3614 modem unit has a TEST UNIT switch behind its rear door. The 3603 modem unit is a small wall-mounted unit that has a single toggle switch and SYNC light (the 3603-1 also has a rotary selector switch) on its front panel.
- 2** The loop speed and address switches are located in different places for different terminals. On the 3604, they are located on the bottom of the terminal; to get at them, you must tip up the 3604. *Have someone help you tip it up.* On the 3606 and 3608, the loop speed, terminal address, and subaddress switches are located behind the red display filter. (The 3606-2 and 3608-2 do not have any loop speed switches.) On the 3610, 3611, 3612, and 3618 printers, the switches are located inside the printer. For the location of the switches on these terminals and for information on the loop speed and address switch settings, see "Loop Speed and Address Switches" under "Installation Details." The 3614 does not have loop speed and address switches; the speed and address are fixed.
 

**CAUTION: The loop speed and address setting should be changed only by authorized personnel under the direction of your institution's management.**
- 3** To pull out the loop cables, all terminals except the 3606-1, 3608-1, 3614, and 3618 must be tipped up. *Have a second person help you tip up the terminal.* The 3606-1 and 3608-1 can be disconnected from the loop by pulling the connector, on the end of the 6-foot (1.8 m) signal cable attached to the unit, straight out from the loop port. To get at the loop cables on a 3614, open its rear door. On the 3618, face the rear of the printer and reach under the right rear corner. On all terminals, the cables are easily removed by grasping the plugs and pulling straight out.
 

**CAUTION: Cables should be removed only by authorized personnel under the direction of your institution's management. If your institution prohibits removing the cables, call your service representative for assistance.**

- d. If this terminal is a 3606-1 or 3608-1, unplug it from the loop port. If this terminal is not a 3606-1 or 3608-1, pull out the loop cables and plug them together. See **1**. If the READY lights on the other terminals on the subloop do not come on, plug this terminal back into the subloop, and go to the next step. If the READY lights do come on, this terminal is failing. Leave the terminal out of the subloop, and:
- If this terminal is a 3606-1 or 3608-1, replace it with a spare.
  - End of procedure.
  - If this terminal is a 3614, refer to the Problem Recovery Procedures in the *3614 Operator's Guide*, GA66-0001.
  - Fill out a Problem Report Sheet for the failing terminal.
  - Call the SR and report the failing terminal; tell the SR to come to your remote location.
  - End of procedure.

01 Have you just completed checking out the last terminal on the subloop whose READY light was flashing (T2 in Figure 3)?

N Y

02 Go to the first terminal on the subloop whose READY light is off (T3 in Figure 3) and continue with step 04 on page 12.

03 Is a Loop Repeater installed on the subloop at this remote location between terminals T2 and T3?

N Y

04 Check to see if the Loop Repeater is failing by:

- Unplugging the Loop Repeater from the subloop.
- Plugging a spare Loop Repeater into the subloop.
- Plugging the power plug of the spare Loop Repeater into an outlet.

05 Did the READY lights on the terminals on the subloop come on?

N Y

06 Replace the original Loop Repeater with a spare.

- End of procedure.

07 If the problem has not been corrected, it is probably a failing loop cable between the last terminal whose READY light is flashing (T2 in Figure 3) and the first terminal whose READY light is off (T3 in Figure 3). Try a spare cable. If this does not correct the problem:

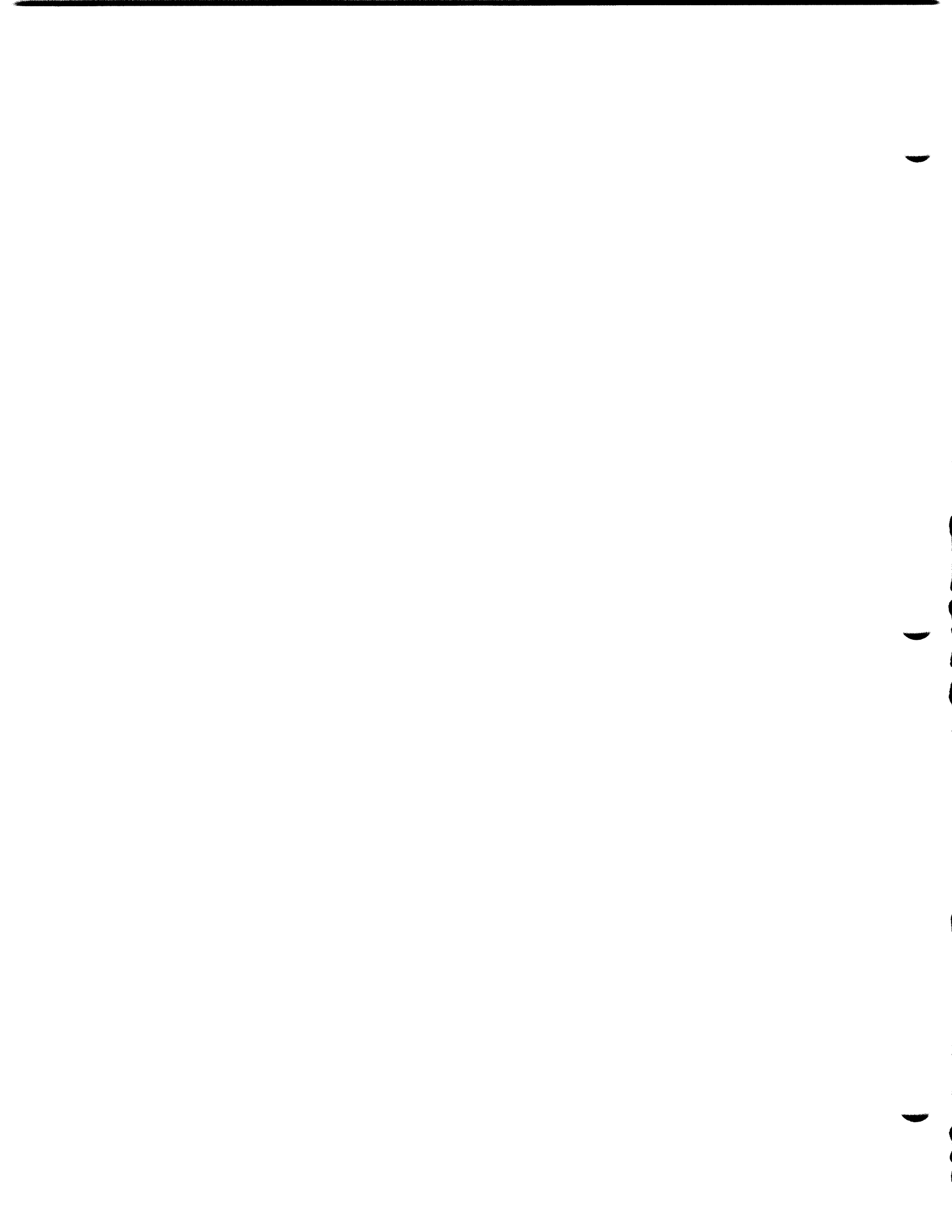
- Call your local location and tell the control operator that your remote loop is failing. Follow the control operator's instructions. See **2**.
- Fill out a Problem Report Sheet for the failing loop.
- End of procedure.

## Notes

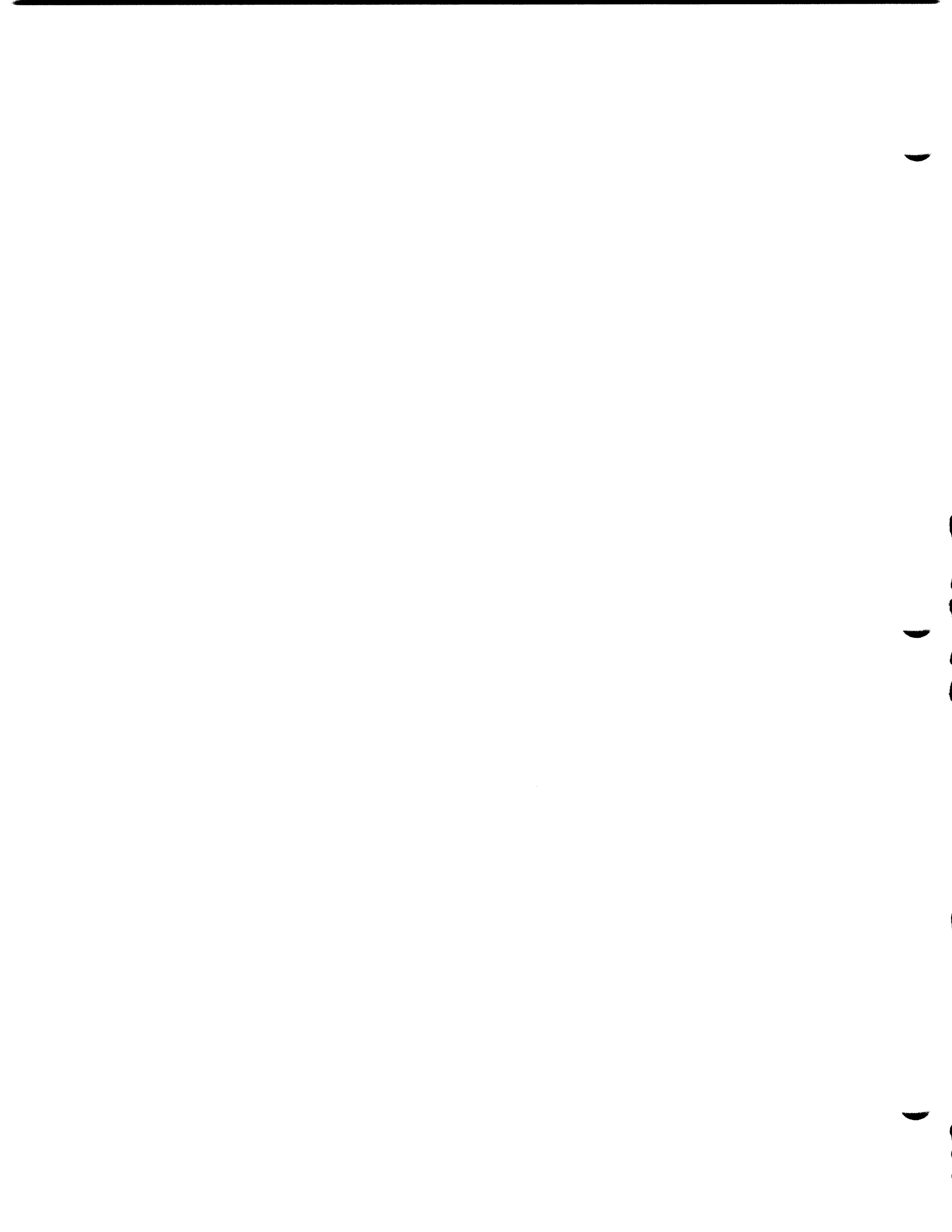
- 1** To pull out the loop cables, all terminals except the 3606-1, 3608-1, 3614, and 3618 must be tipped up. *Have a second person help you tip up the terminal.* The 3606-1 and 3608-1 can be disconnected from the loop by pulling the connector, on the end of the 6-foot (1.8 m) signal cable attached to the unit, straight out from the loop port. To get at the loop cables on a 3614, open its rear door. On the 3618, face the rear of the printer and reach under the right rear corner. On all terminals, the cables are easily removed by grasping the plugs and pulling straight out.

**CAUTION:** Cables should be removed only by authorized personnel under the direction of your institution's management. If your institution prohibits removing the cables, call your service representative for assistance.

- 2** The local location is the location that has the controller to which your remote subloop is attached.



This page precedes the Problem Recovery, 600-BPS Remote Loop Procedures page 1.



## REMOTE LOCATION, INTEGRATED 600-BPS REMOTE LOOP PROCEDURES

These procedures should be located at every remote location on an integrated 600-bps remote loop. (These 600-bps remote loop procedures are not used in the USA; it deals with a loop speed of 600 bps used in other countries.) The procedures lead you, the remote control operator, through actions that determine the nature and location of the problem. If the problem is with your modem unit or the telephone lines, you are directed to contact the local control operator for instructions. If the problem is with a terminal other than the modem unit or with a loop cable connecting terminals, the procedures isolate the problem and direct your recovery actions.

In these recovery procedures, the READY light on the terminals and the SYNC light on the 3603s play an important role, and many times you are asked to check the condition of these lights.

In the Normal mode, there are only three possible conditions:

1. On (the light is on all the time).
2. Off (the light is off all the time).
3. Flashing (the light is blinking on and off).

In the Wrap Test mode, there are only two possible conditions:

1. On (the light is on all the time).
2. Off (the light is off all the time).

**Note:** *In the Wrap Test mode, if the SYNC light of a 3603 or the READY light of a modem unit should exhibit an occasional flicker, its condition should be considered "on".*

For local location, call \_\_\_\_\_.

For service, call \_\_\_\_\_.

START

See **1**.

When an integrated 600-bps remote loop fails, the problem could be caused by a failure in the controller or its modem (external or integrated) at the local location, in the modem and/or terminals in your remote location, or of the telephone lines connecting the locations. Unlike most external modem or integrated 1200-bps remote loops, however, the 600-bps modem cannot be wrap-tested.

01 Is the READY light on the modem unit on? See **2**.

Y N

02 Refer to Figures 1, 2, and 3. Select the figure that shows the condition of the READY lights on the terminals. Go to the page referenced and follow the procedure on that page.

03 Check that the TEST UNIT/DSBL UNIT switch on the 3604 modem unit is in the normal position. [For a 3614 modem unit, check that the DSBL UNIT switch is in the normal (down) position.]

04 Check the settings of the address switches on all the terminals on the subloop (for 3614s, skip this step). See **3**.

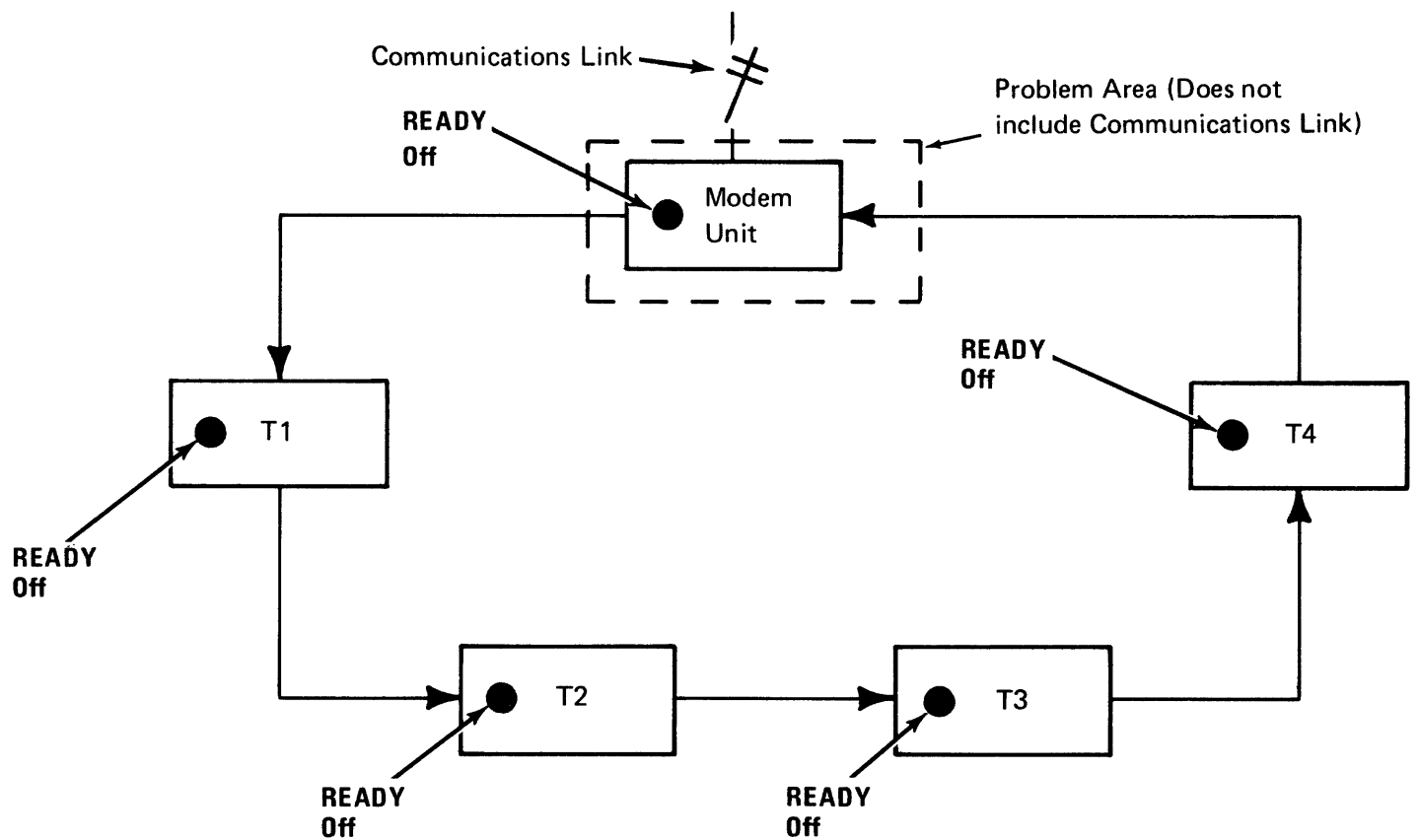
05 Check that the speed switches on all the terminals on the subloop are set to the loop speed. (For 3614s, skip this step.) See **3**.

Notes

- 1** This procedure is not used in the USA. It deals with a loop speed of 600 bps used in other countries.
- 2** In these recovery procedures, a unit that can interface directly with telephone lines or a modem is called a "modem unit." The units in the 3600 system that can interface directly with telephone lines or a modem at 600 bps are: the 3604-2, -3, or -4 and any 3614 model. You can recognize a 3604 modem unit because it has a TEST UNIT/DSBL UNIT switch to the right of the keyboard. A 3614 modem unit has a TEST UNIT switch behind its rear door.
- 3** The loop speed and address switches are located in different places for different terminals. On the 3604, they are located on the bottom of the terminal; to get at them, you must tip up the 3604. *Have someone help you tip it up.* On the 3606 and 3608, the loop speed, terminal address, and subaddress switches are located behind the red display filter. (The 3606-2 and 3608-2 do not have any loop speed switches.) On the 3610, 3611, 3612, and 3618 printers, the switches are located inside the printer. For the location of the switches on these terminals and for information on the loop speed and address switch settings, see "Loop Speed and Address Switches" under "Installation Details." The 3614 does not have loop speed and address switches; the speed and address are fixed

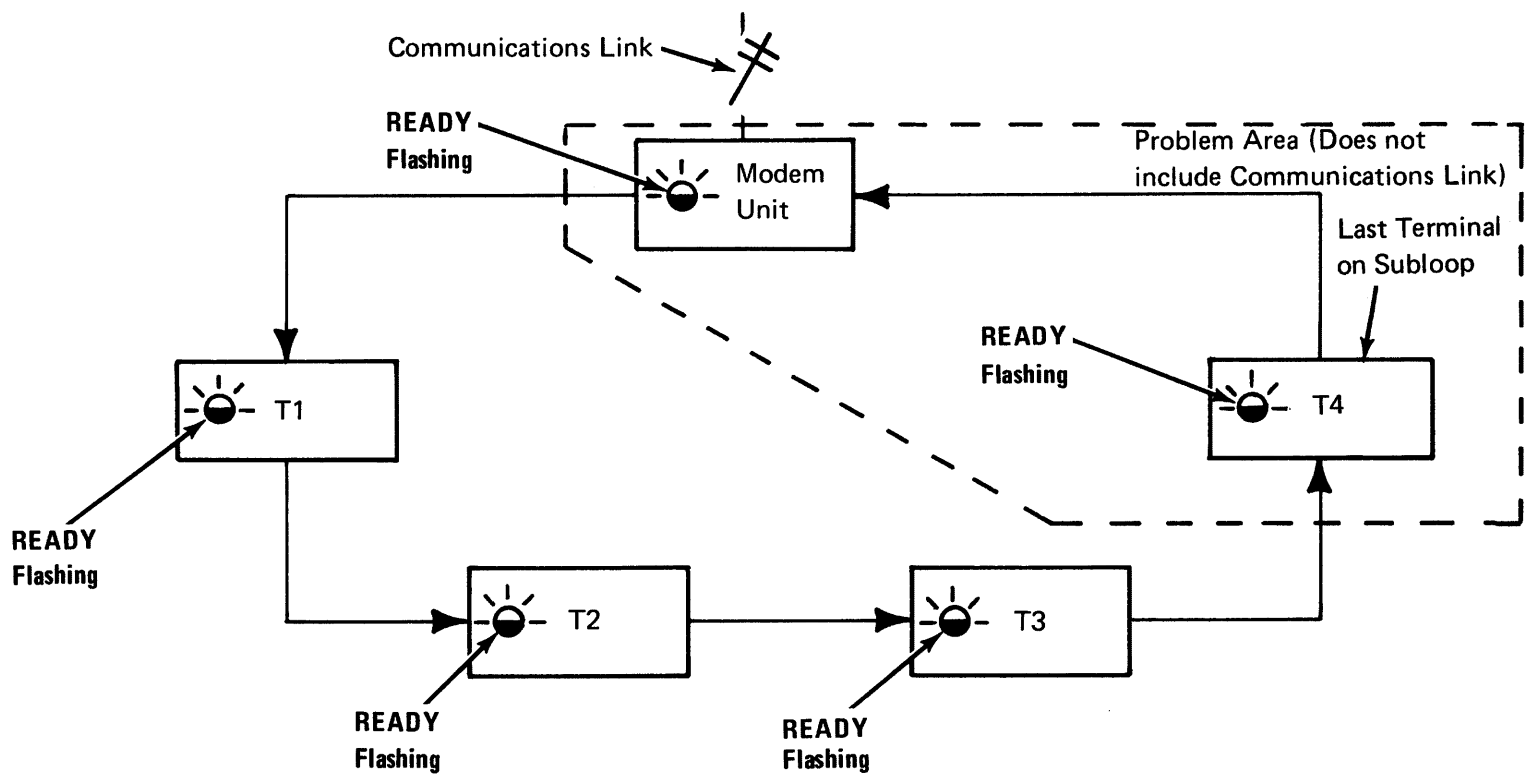
**CAUTION:** The loop speed and address setting should be changed only by authorized personnel under the direction of your institution's management.





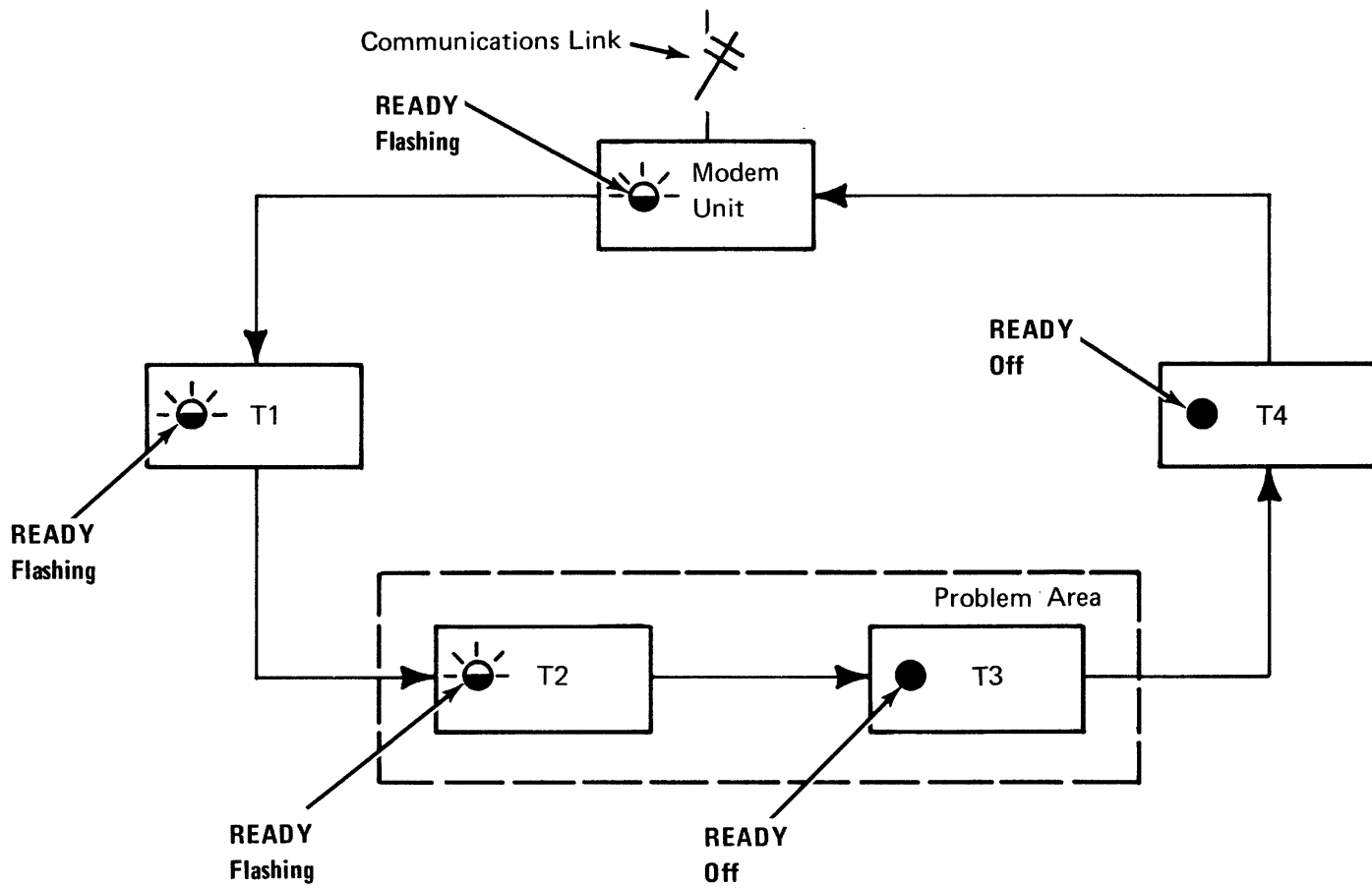
Note: Refer to the Remote Loop Description Sheet for the failing subloop to make sure you know which terminals are on the subloop and the physical order of the terminals on the subloop.

Figure 1. All READY lights are off. Go to AS on page 6.



Note: Refer to the Remote Loop Description Sheet for the failing subloop to make sure you know which terminals are on the subloop and the physical order of the terminals on the subloop.

Figure 2. All READY lights are flashing. Go to AT on page 8.



**Note:** Refer to the Remote Loop Description Sheet for the failing subloop to make sure you know which terminals are on the subloop and the physical order of the terminals on the subloop.

**Figure 3.** Some READY lights are flashing and some are off. Go to AU on page 12.

AR

2

01 Is the subloop operating correctly but one terminal is failing?

N Y

02 At the failing terminal, do the following checks:

- a. Check that the ON/OFF switch is on (press ON).
- b. Check that the power plug is in all the way in the outlet.
- c. Check that there is power at the outlet. See **1**.
- d. If the terminal is a 3614, skip the rest of the checks and refer to the Problem Recovery Procedures in the *3614 Operator's Guide*, GA66-0001.
- e. If the terminal is a printer, check that there are forms in the printer and that they are loaded properly. If the terminal is a 3608-1, check that there is no forms jam or other obstruction in the forms slot.
- f. Check that the covers are closed properly.
- g. Turn off the terminal and then turn it back on. (Skip this step if the terminal is a 3604 modem unit.) See **2**.

If these checks did not correct the problem, go to step 03 or 04 on this page.

03 If the terminal is a 3606-1 or 3608-1:

- Replace the failing terminal with a spare.
- End of procedure.

04 If the terminal is not a 3606-1 or 3608-1:

- Fill out a Problem Report Sheet for the failing terminal.
- Call the SR and report the failing terminal.
- End of procedure.

05 Call your local location and tell the control operator that your remote subloop is failing. Follow the control operator's instructions. See **3**.

## Notes

- 1** If a lamp or any electrical appliance plugged into the outlet works, the outlet has power. If the outlet does not have power, notify the person responsible for building maintenance.
- 2** Turning the terminal off and then on may reset other terminals on the subloop. Therefore, try to verify that the other terminals on the loop are not being used before doing this check. If this is not possible, keep this activity to a minimum.
- 3** The local location is the location that has the controller to which your remote subloop is attached.

AS  
3

- 01 Check that the ON/OFF switch on the modem unit is on. (Press ON.) See **1** .
- 02 Check that the phone connections are correct and secure.
- 03 Check that the speed switches on all terminals are set to the loop speed (for 3614s, skip this step). See **2** .
- 04 Are there more terminals on this subloop beside the modem unit?

N Y

- 05 Press DSBL UNIT on the TEST UNIT/DSBL UNIT switch on the 3604 modem. [For a 3614 modem unit, set its DSBL UNIT switch to the DSBL UNIT position (up position).] Do the READY lights on the terminals come on?

N Y

- 06 Leave the modem unit on and the switch in DSBL UNIT. The modem unit is failing.
- If the modem unit is a 3614, refer to the Problem Recovery Procedures in the *3614 Operator's Guide, GA66-0001*.
  - Fill out a Problem Report Sheet for the modem unit.
  - Call your local location and tell the control operator that your modem unit and remote location are failing. Follow the control operator's instructions. See **3** .

## Notes

- 1** In these recovery procedures, a unit that can interface directly with telephone lines or a modem is called a "modem unit." The units in the 3600 system that can interface directly with telephone lines or a modem at 600 bps are: the 3604-2, -3, or -4 and any 3614 model. You can recognize a 3604 modem unit because it has a TEST UNIT/DSBL UNIT switch to the right of the keyboard. A 3614 modem unit has a TEST UNIT switch behind its rear door.
- 2** The loop speed and address switches are located in different places for different terminals. On the 3604, they are located on the bottom of the terminal; to get at them, you must tip up the 3604. *Have someone help you tip it up.* On the 3606 and 3608, the loop speed, terminal address, and sub-address switches are located behind the red display filter. (The 3606-2 and the 3608-2 do not have any loop speed switches.) On the 3610, 3611, 3612, and 3618 printers, the switches are located inside the printer. For the location of the switches on these terminals and for information on the loop speed and address switch settings, see "Loop Speed and Address Switches" under "Installation Details." The 3614 does not have loop speed and address switches; the speed and address are fixed.

**CAUTION:** The loop speed and address setting should be changed only by authorized personnel under the direction of your institution's management.

- 3** The local location is the location that has the controller to which your remote subloop is attached.

7  
AV

AV  
6

01 Is the modem unit a 3604?

N Y

02 Press TEST UNIT on the TEST UNIT/DSBL UNIT switch on the 3604 modem unit. Does the 1 light on the 3604 modem unit come on?

Y N

03 The 3604 modem unit is failing:

- Fill out a Problem Report Sheet for the 3604 modem unit.
- Call your local location and tell the control operator that your 3604 modem unit and remote location are failing. Follow the control operator's instructions. See **1**.

04 Call your local location and tell the control operator the condition of all the READY lights. Follow the operator's instructions. See **1**.

05 On the 3614 modem unit, is the TSLD light on the operator's panel on? See **2**.

Y N

06 The 3614 modem unit is failing.

- Refer to the Problem Recovery Procedures in the *3614 Operator's Guide, GA66-0001*.
- Call your local location and tell the control operator that your 3614 modem unit and remote location are failing. Follow the control operator's instructions. See **1**.

07 Call your local location and tell the control operator the condition of all the READY lights. Follow the control operator's instructions. See **1**.

## Notes

- 1** The local location is the location that has the controller to which your remote subloop is attached.
- 2** In these recovery procedures, a unit that can interface directly with telephone lines or a modem is called a "modem unit." The units in the 3600 system that can interface directly with telephone lines or a modem at 600 bps are: the 3604-2, -3, or -4 and any 3614 model. You can recognize a 3604 modem unit because it has a TEST UNIT/DSBL UNIT switch to the right of the keyboard. A 3614 modem unit has a TEST UNIT switch behind its rear door.

AT

3

|

01 Is the modem unit a 3604? See **1** .

N Y

|

02 Press TEST UNIT on the TEST UNIT/DSBL UNIT switch on the 3604 modem unit. Does the 1 light come on?

Y N

|

03 The 3604 modem unit is failing.

- Fill out a Problem Report Sheet for the 3604 modem unit.
- Call your local location and tell the control operator that your 3604 modem unit and remote location are failing. Follow the control operator's instructions. See **2** .

04 Go to AW on page 9.

05 On the 3614 modem unit, is the TSLD light on the operator's panel on?

Y N

|

- The 3614 modem unit is failing.
- Refer to the Problem Recovery Procedures in the *3614 Operator's Guide*, GA66-0001.
- Call your local location and tell the control operator that your 3614 modem unit and remote location are failing. Follow the control operator's instructions. See **2** .

9

AW

### Notes

- 1** In these recovery procedures, a unit that can interface directly with telephone lines or a modem is called a "modem unit." The units in the 3600 system that can interface directly with telephone lines or a modem at 600 bps are: the 3604-2, -3, or -4 and any 3614 model. You can recognize a 3604 modem unit because it has a TEST UNIT/DSBL UNIT switch to the right of the keyboard. A 3614 modem unit has a TEST UNIT switch behind its rear door.
- 2** The local location is the location that has the controller to which your remote subloop is attached.

AW

8

|

01 Check that the speed switches on all terminals are set to the loop speed. See **1**.

02 Check that the phone connections are correct and secure.

03 Are there more terminals on this subloop beside the modem unit?

Y N

|

04 Pull out the loop cables and plug them in again (they may be loose). See **2**.

05 If the above step did not correct the problem:

- Call your local location and tell the control operator that your remote loop is failing. Follow the control operator's instructions. See **3**.

06 Go to the *last terminal on the subloop* (T4 in Figure 2) and perform steps a–c. After each step, check the READY lights on the other terminals on the subloop; if the READY lights come on, the step you just did corrected or bypassed the problem.

- a. If terminal T4 is a 3606-1 or 3608-1, unplug it from the loop port and plug it back in. If T4 is not a 3606-1 or 3608-1, pull out the loop cables and plug them in again. The connectors may not have been fully seated. See **2**.

10

AX

## Notes

- 1** The loop speed and address switches are located in different places for different terminals. On the 3604, they are located on the bottom of the terminal; to get at them, you must tip up the 3604. *Have someone help you tip it up.* On the 3606 and 3608, the loop speed, terminal address, and subaddress switches are located behind the red display filter. (The 3606-2 and 3608-2 do not have any loop speed switches.) On the 3610, 3611, 3612, and 3618 printers, the switches are located inside the printer. For the location of the switches on these terminals and for information on the loop speed and address switch settings, see "Loop Speed and Address Switches" under "Installation Details." The 3614 does not have loop speed and address switches; the speed and address are fixed.

**CAUTION:** The loop speed and address setting should be changed only by authorized personnel under the direction of your institution's management.

- 2** To pull out the loop cables, all terminals except the 3603-1, 3608-1, 3614, and 3618 must be tipped up. *Have a second person help you tip up the terminal.* The 3606-1 and 3608-1 can be disconnected from the loop by pulling the connector, on the end of the 6-foot (1.8 m) signal cable attached to the unit, straight out from the loop port. To get at the loop cables on a 3614, open its rear door. On the 3618, face the rear of the printer and reach under the right rear corner. On all terminals, the cables are easily removed by grasping the plugs and pulling straight out.

**CAUTION:** Cables should be removed only by authorized personnel under the direction of your institution's management. If your institution prohibits removing the cables, call your service representative for assistance.

- 3** The local location is the location that has the controller to which your remote subloop is attached.



b. If step a did not correct the problem, turn off terminal T4 unless it is a 3614. If T4 is a 3614, **DON'T TURN IT OFF**, but set its DSBL UNIT switch to the DSBL UNIT position (up position). If the READY lights on the other terminals on the sub-loop *do not* come on, turn T4 back on and go to step c. If the READY lights *do* come on, terminal T4 is failing. Leave T4 turned off (or the switch in DSBL UNIT) and:

- If T4 is a 3606-1 or 3608-1, replace the terminal with a spare.
- End of procedure.
  
- If T4 is a 3614, refer to the Problem Recovery Procedures in the *3614 Operator's Guide*, GA66-0001.
- Fill out a Problem Report Sheet for the failing terminal.
- Call the SR and report the failing terminal; tell the SR to come to your remote location.
- End of procedure.

c. If terminal T4 is a 3606-1 or 3608-1, unplug it from the loop port. If T4 is not a 3606-1 or 3608-1, pull out its loop cables and plug them together. See **1**. If the READY lights on the other terminals on the subloop do not come on, plug the terminal back into the loop, and go to the next step. If the READY lights do come on, terminal T4 is failing. If terminal T4 is a 3606-1 or 3608-1:

- Replace the failing terminal with a spare.
- End of procedure.

If terminal T4 is not a 3606-1 or 3608-1:

- If T4 is a 3614, refer to the Problem Recovery Procedures in the *3614 Operator's Guide*, GA66-0001.
- Fill out a Problem Report Sheet for the failing terminal.
- Call the SR and report the failing terminal; tell the SR to come to your remote location.
- End of procedure.

- 1** To pull out the loop cables, all terminals except the 3606-1, 3608-1, 3614, and 3618 must be tipped up. *Have a second person help you tip up the terminal.* The 3606-1 and 3608-1 can be disconnected from the loop by pulling the connector, on the end of the 6-foot (1.8 m) signal cable attached to the unit, straight out from the loop port. To get at the loop cables on a 3614, open its rear door. On the 3618, face the rear of the printer and reach under the right corner. On all terminals, the cables are easily removed by grasping the plugs and pulling straight out.

**CAUTION:** Cables should be removed only by authorized personnel under the direction of your institution's management. If your institution prohibits removing the cables, call your service representative for assistance.

AY  
10  
|

01 Go to the modem unit and do steps a and b. After each step, check the READY lights on the other terminals on the subloop. If the READY lights come on, the step you just did corrected or bypassed the problem.

- a. Pull out the loop cables and plug them in again (they may be loose). See **1**.
- b. If step a did not correct the problem, press DSBL UNIT on the TEST UNIT/DSBL UNIT switch. [For a 3614 modem unit, set its DSBL UNIT switch to DSBL UNIT position (up position).] Do the READY lights on the other terminals on the subloop come on?

Y N

02 Is a Loop Repeater installed on the loop at this remote location between terminal T4 and the modem unit?

N Y

03 Check to see if the Loop Repeater is failing by:

- Unplugging the Loop Repeater from the loop.
- Plugging a spare Loop Repeater into the loop.
- Plugging the power plug of the spare Loop Repeater into an outlet.

04 Did the READY lights on the terminals on the subloop come on?

N Y

05 Replace the original Loop Repeater with a spare.

- End of procedure.

06 The problem is probably a failing loop cable between terminal T4 and the modem unit. Try a spare cable. If this does not correct the problem:

- Fill out a Problem Report Sheet for the failing subloop.
- Call your local location and tell the control operator that your remote loop is failing. Follow the control operator's instructions. See **2**.

07 The modem unit is failing:

- If it is a 3614, refer to the Problem Recovery Procedures in the *3614 Operator's Guide*, GA66-0001.
- Fill out a Problem Report Sheet for the failing modem unit.
- Call your local location and tell the control operator that your modem unit and remote location are failing. Follow the control operator's instructions. See **2**.

## Notes

- 1** To pull out the loop cables, all terminals except the 3606-1, 3608-1, 3614, and 3618 must be tipped up. *Have a second person help you tip up the terminal.* The 3606-1 and 3608-1 can be disconnected from the loop by pulling the connector, on the end of the 6-foot (1.8 m) signal cable attached to the unit, straight out from the loop port. To get at the loop cables on a 3614, open its rear door. On the 3618, face the rear of the printer and reach under the right rear corner. On all terminals, the cables are easily removed by grasping the plugs and pulling straight out.

**CAUTION:** Cables should be removed only by authorized personnel under the direction of your institution's management. If your institution prohibits removing the cables, call your service representative for assistance.

- 2** The local location is the location that has the controller to which your remote subloop is attached.

- 01 Turn on all terminals on the subloop.
- 02 Go to the last terminal on the subloop whose READY light is flashing (T2 in Figure 3) and continue with step 03 on this page.
- 03 At this terminal perform steps a–d below. After each step, check the READY lights on the other terminals on the subloop. If the READY lights come on, the step you just did corrected or bypassed the problem:
- Check that the speed switches on this terminal are set to the loop speed. (If this terminal is a 3614, skip this step.) See **1**.
  - If step a did not correct the problem, and if this terminal is a 3606-1 or 3608-1, unplug it from the loop port and plug it back in. If this terminal is not a 3606-1 or 3608-1, pull out the loop cables from this terminal and plug them in again. The connectors may not have been fully seated. See **2**.
  - If step b did not correct the problem, turn off this terminal unless it is a 3614. If this terminal is a 3614, **DON'T TURN IT OFF**, but set its DSBL UNIT switch to the DSBL UNIT position (up position). If the READY lights on the other terminals on the subloop *do not* come on, turn this terminal back on and go to step d. If the READY lights *do* come on, this terminal is failing. Leave this terminal turned off (or the switch in DSBL UNIT position) and:
    - If this terminal is a 3606-1 or 3608-1, replace the terminal with a spare.
    - End of procedure.
    - If this terminal is a 3614, refer to the Problem Recovery Procedures in the *3614 Operator's Guide*, GA66-0001.
    - Fill out a Problem Report Sheet for the failing terminal.
    - Call the SR and report the failing terminal; tell the SR to come to your remote location.
    - End of procedure.

## Notes

- 1** The loop speed and address switches are located in different places for different terminals. On the 3604, they are located on the bottom of the terminal; to get at them, you must tip up the 3604. *Have someone help you tip it up.* On the 3606 and 3608, the loop speed, terminal address, and subaddress switches are located behind the red display filter. (The 3606-2 and 3608-2 do not have any loop speed switches.) On the 3610, 3611, 3612, and 3618 printers, the switches are located inside the printer. For the location of the switches on these terminals and for information on the loop speed and address switch settings, see "Loop Speed and Address Switches" under "Installation Details." The 3614 does not have loop speed and address switches; the speed and address are fixed.

**CAUTION:** The loop speed and address setting should be changed only by authorized personnel under the direction of your institution's management.

- 2** To pull out the loop cables, all terminals except the 3606-1, 3608-1, 3614, and 3618 must be tipped up. *Have a second person help you tip up the terminal.* The 3606-1 and 3608-1 can be disconnected from the loop by pulling the connector, on the end of the 6-foot (1.8 m) signal cable attached to the unit, straight out from the loop port. To get at the loop cables on a 3614, open its rear door. On the 3618, face the rear of the printer and reach under the right rear corner. On all terminals, the cables are easily removed by grasping the plugs and pulling straight out.

**CAUTION:** Cables should be removed only by authorized personnel under the direction of your institution's management. If your institution prohibits removing the cables, call your service representative for assistance.

AZ

12

d. If this terminal is a 3606-1 or 3608-1, unplug it from the loop port. If this terminal is not a 3606-1 or 3608-1, pull out the loop cables and plug them together. See **1**. If the READY lights on the other terminals on the subloop do not come on, plug this terminal back into the subloop, and go to the next step. If the READY lights do come on, this terminal is failing. Leave the terminal out of the subloop, and:

- If this terminal is a 3606-1 or 3608-1, replace it with a spare.
- End of procedure.
  
- If this terminal is a 3614, refer to the Problem Recovery Procedures in the *3614 Operator's Guide*, GA66-0001.
- Fill out a Problem Report Sheet for the failing terminal.
- Call the SR and report the failing terminal; tell the SR to come to your remote location.
- End of procedure.

01 Have you just completed checking out the last terminal on the subloop whose READY light was flashing (T2 in Figure 3)?

N Y

02 Go to the first terminal on the subloop whose READY light is off (T3 in Figure 3) and continue with step 03 on page 12.

03 Is a Loop-Repeater installed on the subloop at this remote location between terminals T2 and T3?

N Y

04 Check to see if the Loop Repeater is failing by:

- Unplugging the Loop Repeater from the subloop.
- Plugging a spare Loop Repeater into the subloop.
- Plugging the power plug of the spare Loop Repeater into an outlet.

05 Did the READY lights on the terminals on the subloop come on?

N Y

06 Replace the original Loop Repeater with a spare.

- End of procedure.

07 If the problem has not been corrected, it is probably a failing loop cable between the last terminal whose READY light is flashing (T2 in Figure 3) and the first terminal whose READY light is off (T3 in Figure 3).

Try a spare cable. If this does not correct the problem:

- Call your local location and tell the control operator that your remote loop is failing. Follow the control operator's instructions. See **2**.
- Fill out a Problem Report Sheet for the failing loop.
- End of procedure.

## Notes

**1** To pull out the loop cables, all terminals except the 3606-1, 3608-1, 3614, and 3618 must be tipped up. *Have a second person help you tip up the terminal.* The 3606-1 and 3608-1 can be disconnected from the loop by pulling the connector, on the end of the 6-foot (1.8 m) signal cable attached to the unit, straight out from the loop port. To get at the loop cables on a 3614, open its rear door. On the 3618, face the rear of the printer and reach under the right rear corner. On all terminals, the cables are easily removed by grasping the plugs and pulling straight out.

**CAUTION:** Cables should be removed only by authorized personnel under the direction of your institution's management. If your institution prohibits removing the cables, call your service representative for assistance.

**2** The local location is the location that has the controller to which your remote subloop is attached.



**Contents – Problem Report Sheets**

General

3600 System/Controller Problem Report

3604 Problem Report

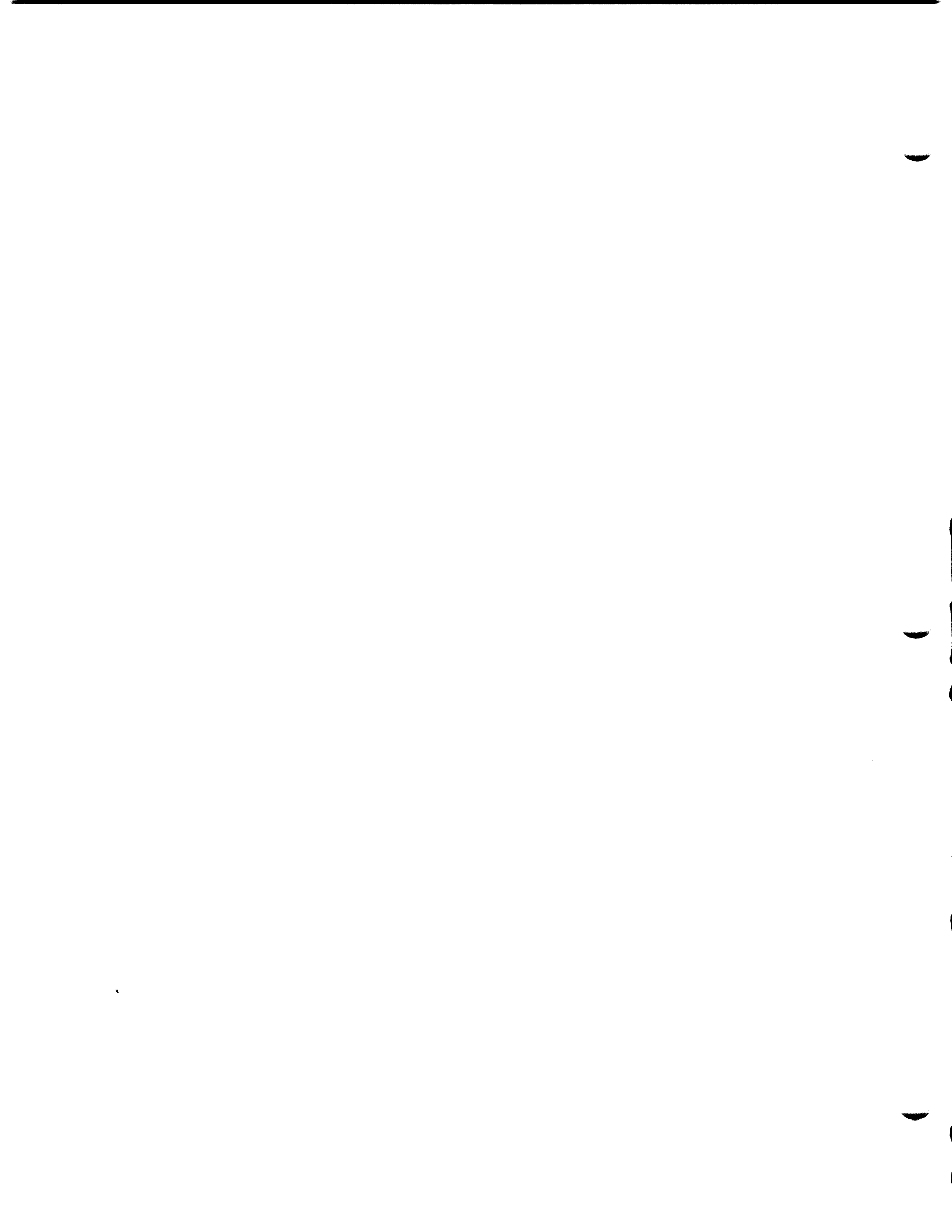
3610 Problem Report

3611 Problem Report

3612 Problem Report

3618 Problem Report

This page precedes the Problem Recovery, Problem Report Sheets page 1.





## Problem Report Sheets

### GENERAL

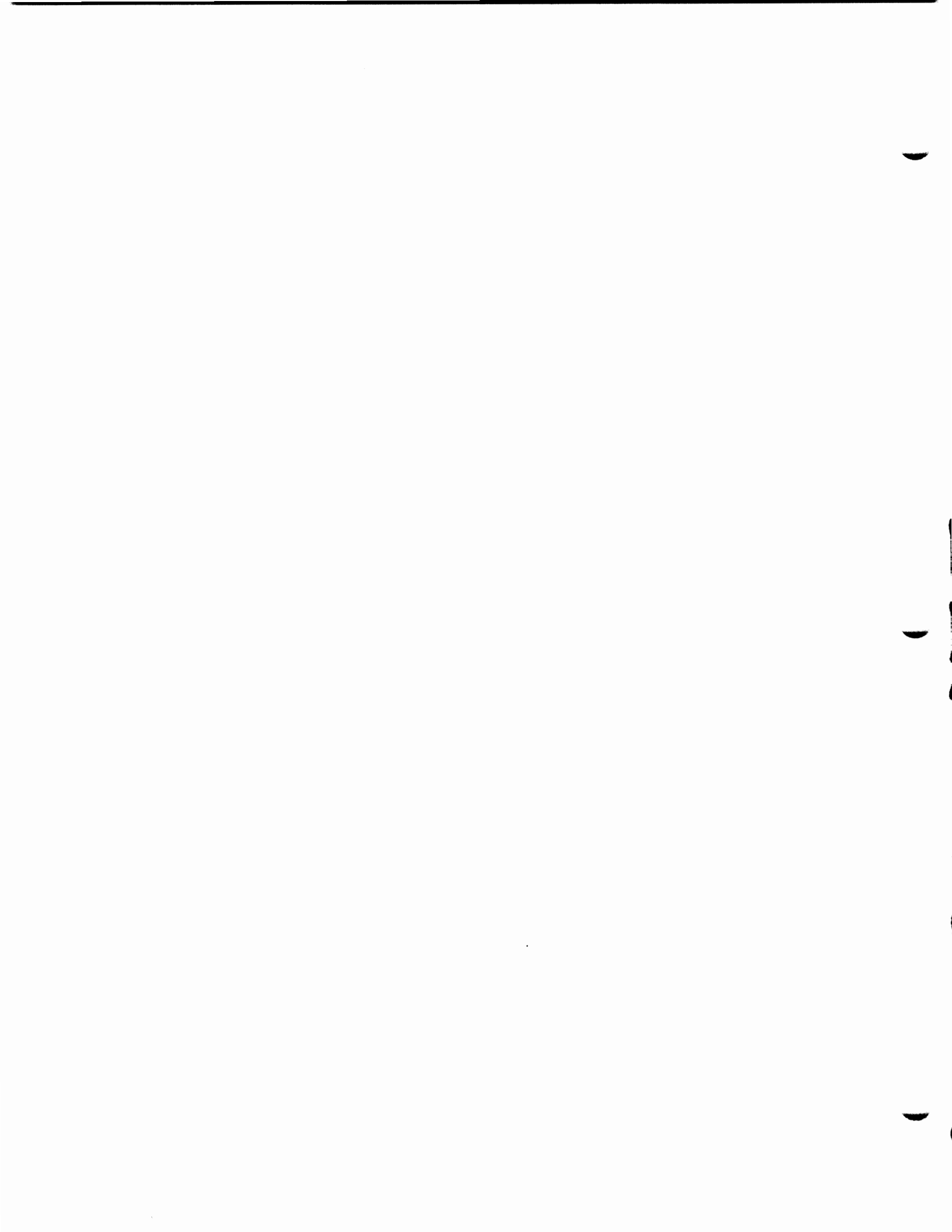
This subsection contains problem report sheets designed for each terminal. These sheets are time-saving aids for both you and the service representative. In many cases, the information about the failure on the problem report sheet will help isolate the problem quickly. When you have a problem or a failing unit, fill out the appropriate sheet to provide information about the problem for the service representative who may come later.

Three copies of each problem report sheet are provided here; but you may order additional sheets in pads of 25, by means of their associated form number:

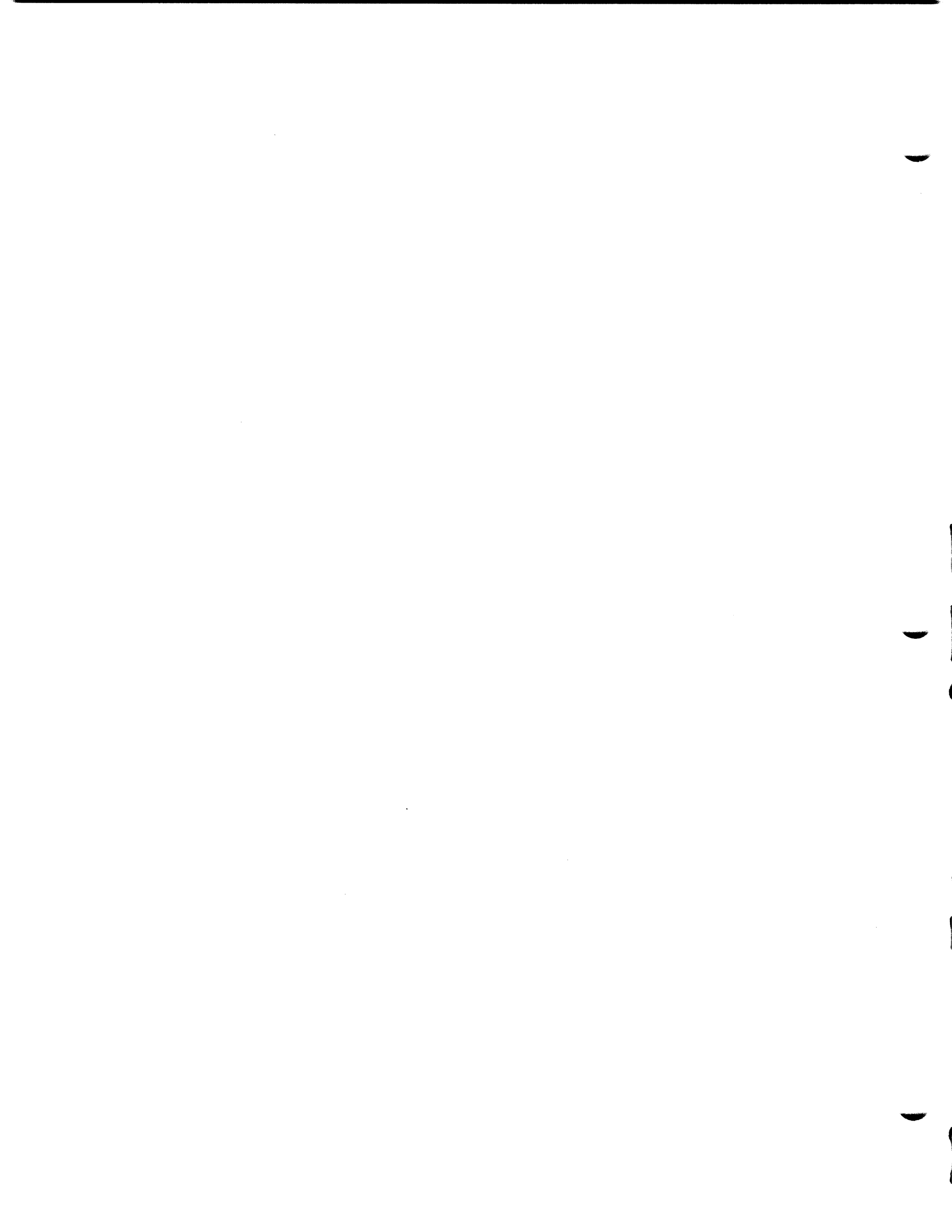
- 3600 System/Controller Problem Report, Form GX27-2958.
- 3604 Problem Report, Form GX27-2959.
- 3610 Problem Report, Form GX27-2960.
- 3611 Problem Report, Form GX27-2977.
- 3612 Problem Report, Form GX27-2961.
- 3618 Problem Report, Form GX27-2962.

The 3603, 3606, and 3608 are repair-center-serviced units. Use the special repair authorization form, GX27-2981.

For 3614 problem reports, refer to the *IBM 3614 Consumer Transaction Facility Operator's Guide*, Form GA66-0001.



This page precedes the 3600 System/Controller Problem Report sheets.



# 3600 System/Controller Problem Report

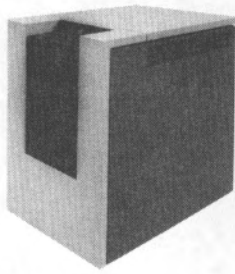
Check the box next to all statements that accurately describe the problem.

Date and Time: \_\_\_\_\_

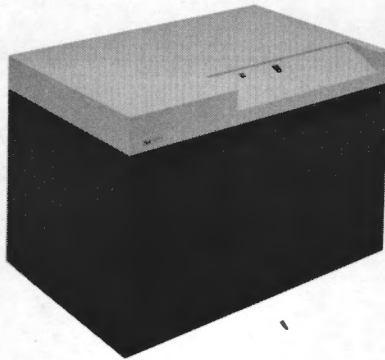
Reported By: \_\_\_\_\_

Controller Identification: \_\_\_\_\_

Control Operator 3604: \_\_\_\_\_



3601



3602

Power problem.

Is the power cord plugged into a good outlet?

### Diskette or Disk File Problem

- Cannot load a diskette — mechanical problem
- Diskette does not turn
- Diskette track pointer does not move
- Diskette track pointer does not go to 0 during startup
- Abnormally noisy

#### Failing Commands\*:

|       |       |       |       |
|-------|-------|-------|-------|
| __030 | __042 | __093 | __999 |
| __031 | __090 | __094 |       |
| __032 | __091 | __888 |       |
| __034 | __092 | __936 |       |

### Startup Problem (Using Controller and Control Operator 3604)

- Stops with no message displayed
- Startup completes but no terminals respond
- Log message 11 001

Stops with this message displayed:  
\_\_\_\_\_

### Operating Normally — Problem Occurred

#### CONTROLLER LOG MESSAGE

- 11 004 \_\_\_\_\_
- 11 005 LOOP \_\_\_\_\_ ERROR, CODE = \_\_\_\_\_
- 11 006 LINK ERROR \_\_\_\_\_, \_\_\_\_\_
- 11 007 \_\_\_\_\_

Control Operator CHECK light on.

No terminals respond, no message displayed

### Failing Commands\*:

|       |       |       |       |       |       |       |       |       |       |       |       |       |
|-------|-------|-------|-------|-------|-------|-------|-------|-------|-------|-------|-------|-------|
| __000 | __005 | __008 | __012 | __023 | __028 | __040 | __044 | __047 | __051 | __060 | __063 | __070 |
| __001 | __006 | __009 | __020 | __024 | __033 | __041 | __045 | __048 | __052 | __061 | __066 | __071 |
| __002 | __007 | __010 | __021 | __025 | __035 | __043 | __046 | __049 | __053 | __062 | __069 | __123 |

Problem is described below.

\*Failing control operator commands that test specific terminals appear on the Problem Report Sheet for that terminal.

Address comments concerning this form to  
IBM Corporation, SCD, Dept. 52L  
Neighborhood Road, Kingston, N.Y. 12401

**Problem Recovery**

GX27-2958-4 U/M 025\*  
Printed in U.S.A.

\*No. of forms per pad may vary slightly

**Problem Report Sheets**

# 3600 System/Controller Problem Report

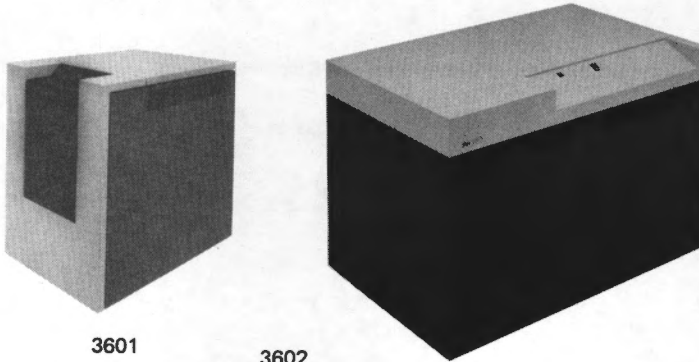
Check the box next to all statements that accurately describe the problem.

Date and Time: \_\_\_\_\_

Reported By: \_\_\_\_\_

Controller Identification: \_\_\_\_\_

Control Operator 3604: \_\_\_\_\_



3601

3602

Power problem.

Is the power cord plugged into a good outlet?

|  |  |  |
|--|--|--|
| <b>Diskette or Disk File Problem</b>   |  | Failing Commands*:   |
| <input type="checkbox"/> Cannot load a diskette – mechanical problem<br><input type="checkbox"/> Diskette does not turn<br><input type="checkbox"/> Diskette track pointer does not move<br><input type="checkbox"/> Diskette track pointer does not go to 0 during startup<br><input type="checkbox"/> Abnormally noisy | _ 030   _ 042   _ 093   _ 999<br>_ 031   _ 090   _ 094<br>_ 032   _ 091   _ 888<br>_ 034   _ 092   _ 936 |  |
| <b>Startup Problem (Using Controller and Control Operator 3604)</b>  |  |  |
| <input type="checkbox"/> Stops with no message displayed<br><input type="checkbox"/> Startup completes but no terminals respond<br><input type="checkbox"/> Log message 11 001   | <input type="checkbox"/> Stops with this message displayed:<br>_____                                     |  |
| <b>Operating Normally – Problem Occurred</b>   |  |  |
| CONTROLLER LOG MESSAGE   |  |  |
| <input type="checkbox"/> 11 004 _____<br><input type="checkbox"/> 11 005 LOOP _____ ERROR, CODE = _____<br><input type="checkbox"/> 11 006 LINK ERROR _____,<br><input type="checkbox"/> 11 007 _____  |  |  |
| <input type="checkbox"/> Control Operator CHECK light on.  |  | <input type="checkbox"/> No terminals respond,<br>no message displayed |
| <b>Failing Commands*:</b>  |  |  |
| _ 000   _ 005   _ 008   _ 012   _ 023   _ 028   _ 040   _ 044   _ 047   _ 051   _ 060   _ 063   _ 070<br>_ 001   _ 006   _ 009   _ 020   _ 024   _ 033   _ 041   _ 045   _ 048   _ 052   _ 061   _ 066   _ 071<br>_ 002   _ 007   _ 010   _ 021   _ 025   _ 035   _ 043   _ 046   _ 049   _ 053   _ 062   _ 069   _ 123  |  |  |

Problem is described below.

\*Failing control operator commands that test specific terminals appear on the Problem Report Sheet for that terminal.

Address comments concerning this form to  
 IBM Corporation, SCD, Dept. 52L  
 Neighborhood Road, Kingston, N.Y. 12401

GX27-2958-4 U/M 025\*  
 Printed in U.S.A.

\*No. of forms per pad may vary slightly

# 3600 System/Controller Problem Report

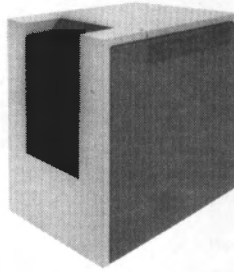
Check the box next to all statements that accurately describe the problem.

Date and Time: \_\_\_\_\_

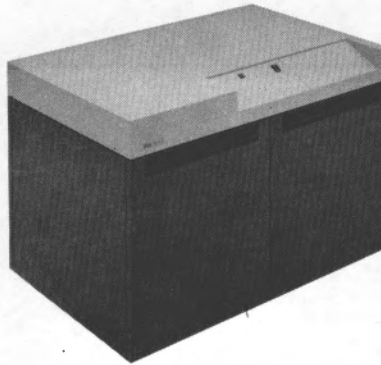
Reported By: \_\_\_\_\_

Controller Identification: \_\_\_\_\_

Control Operator 3604: \_\_\_\_\_



3601



3602

Power problem.

Is the power cord plugged into a good outlet?

|   |  |                    |
|---|--|--------------------|
| <b>Diskette or Disk File Problem</b>  |  | Failing Commands*: |
| <input type="checkbox"/> Cannot load a diskette -- mechanical problem<br><input type="checkbox"/> Diskette does not turn<br><input type="checkbox"/> Diskette track pointer does not move<br><input type="checkbox"/> Diskette track pointer does not go to 0 during startup<br><input type="checkbox"/> Abnormally noisy | _ 030   _ 042   _ 093   _ 999<br>_ 031   _ 090   _ 094<br>_ 032   _ 091   _ 888<br>_ 034   _ 092   _ 936 |                    |
| <b>Startup Problem (Using Controller and Control Operator 3604)</b>   |  |                    |
| <input type="checkbox"/> Stops with no message displayed<br><input type="checkbox"/> Startup completes but no terminals respond<br><input type="checkbox"/> Log message 11 001  | <input type="checkbox"/> Stops with this message displayed:<br>_____                                     |                    |
| <b>Operating Normally -- Problem Occurred</b>   |  |                    |
| CONTROLLER LOG MESSAGE  |  |                    |
| <input type="checkbox"/> 11 004 _____<br><input type="checkbox"/> 11 005 LOOP _____ ERROR, CODE = _____<br><input type="checkbox"/> 11 006 LINK ERROR _____,<br><input type="checkbox"/> 11 007 _____   |  |                    |
| <input type="checkbox"/> Control Operator CHECK light on.   | <input type="checkbox"/> No terminals respond, no message displayed                                      |                    |
| <b>Failing Commands*:</b>   |  |                    |
| _ 000   _ 005   _ 008   _ 012   _ 023   _ 028   _ 040   _ 044   _ 047   _ 051   _ 060   _ 063   _ 070<br>_ 001   _ 006   _ 009   _ 020   _ 024   _ 033   _ 041   _ 045   _ 048   _ 052   _ 061   _ 066   _ 071<br>_ 002   _ 007   _ 010   _ 021   _ 025   _ 035   _ 043   _ 046   _ 049   _ 053   _ 062   _ 069   _ 123   |  |                    |

Problem is described below.

\*Failing control operator commands that test specific terminals appear on the Problem Report Sheet for that terminal.

Address comments concerning this form to  
 IBM Corporation, SCD, Dept. 52L  
 Neighborhood Road, Kingston, N.Y. 12401

GX27-2958-4 U/M 025\*  
 Printed in U.S.A.

\*No. of forms per pad may vary slightly



This page precedes the 3604 Problem Report sheets.



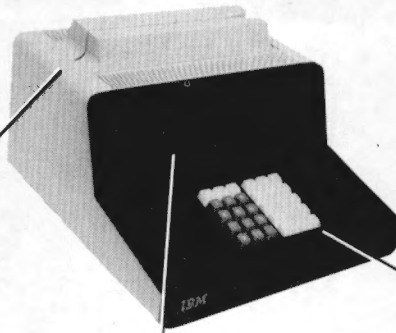
# 3604 Problem Report

Check the box next to the failing function and all statements that accurately describe the problem.

Date and Time: \_\_\_\_\_

Reported By: \_\_\_\_\_

Terminal Identification: \_\_\_\_\_



Power problem.

Is the power cord plugged into a good outlet?

|   |  |  |
|---|--|--|
| <p><input type="checkbox"/> <b>Encoder/Reader</b></p> <p>CHECK light comes on when:</p> <p><input type="checkbox"/> Any document is read.<br/> <input type="checkbox"/> Any document is encoded.</p> <p>Problem is:</p> <p><input type="checkbox"/> Documents won't pass through the read slot.<br/> <input type="checkbox"/> No system response when document is passed through read slot.</p> | <p><input type="checkbox"/> <b>Display Screen</b></p> <p>Nothing displays – screen is:</p> <p><input type="checkbox"/> Completely blank.<br/> <input type="checkbox"/> Filled with dots.</p> <p>Problem is:</p> <p><input type="checkbox"/> No cursor<br/> <input type="checkbox"/> A line of dots across the screen.</p> <p>Character Problems:</p> <p><input type="checkbox"/> Characters are displayed in the wrong positions.<br/> <input type="checkbox"/> Wrong characters are displayed.<br/> <input type="checkbox"/> Partial characters are displayed.<br/> <input type="checkbox"/> Characters contain extra dots.</p> | <p><input type="checkbox"/> <b>Keyboard</b></p> <p>CHECK light comes on when:</p> <p><input type="checkbox"/> Pressing only one or certain keys. They are: _____</p> <p><input type="checkbox"/> Pressing any key.</p> <p>Problem is:</p> <p><input type="checkbox"/> CHECK light is always on.<br/> <input type="checkbox"/> All keys fail.<br/> <input type="checkbox"/> One block of keys fail:<br/> <input type="checkbox"/> Alpha<br/> <input type="checkbox"/> Numeric<br/> <input type="checkbox"/> Special</p> |
| <p><b>Control Operator Command(s) Fail</b></p> <p><input type="checkbox"/> 044    <input type="checkbox"/> _____</p>  | <p><input type="checkbox"/> 020    <input type="checkbox"/> 021    <input type="checkbox"/> 023<br/> <input type="checkbox"/> 025    <input type="checkbox"/> 048    <input type="checkbox"/> 069</p>  | <p><input type="checkbox"/> 024    <input type="checkbox"/> 028<br/> <input type="checkbox"/> 069</p>  |

## Loop Problem

Check the boxes that describe the condition of the lights listed for your loop.

|            |       | TEST UNIT Switch Not Pressed    |                                   |                              | TEST UNIT Switch Pressed    |                                |                              |                             |
|------------|-------|---------------------------------|-----------------------------------|------------------------------|-----------------------------|--------------------------------|------------------------------|-----------------------------|
| Loop Speed | Other | <input type="checkbox"/> READY: | <input type="checkbox"/> Flashing | <input type="checkbox"/> Off | <input type="checkbox"/> On | <input type="checkbox"/> READY | <input type="checkbox"/> Off | <input type="checkbox"/> On |
|            | 600   | <input type="checkbox"/> READY: | <input type="checkbox"/> Flashing | <input type="checkbox"/> Off | <input type="checkbox"/> On | <input type="checkbox"/> 1     | <input type="checkbox"/> Off | <input type="checkbox"/> On |
|            |       |                                 |                                   |                              |                             | <input type="checkbox"/> 2     | <input type="checkbox"/> Off | <input type="checkbox"/> On |

Problem is described below.

Address comments concerning this form to  
 IBM Corporation, SCD, Dept. 52L  
 Neighborhood Road, Kingston, N.Y. 12401

GX27-2959-2 U/M 025\*  
 Printed in U.S.A.

\*No. of forms per pad may vary slightly

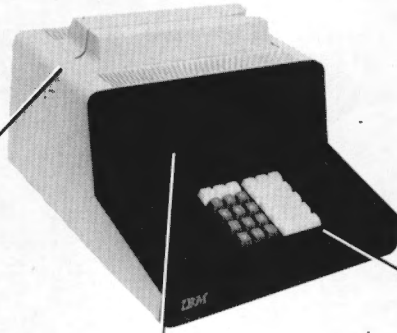
# 3604 Problem Report

Check the box next to the failing function and all statements that accurately describe the problem.

Date and Time: \_\_\_\_\_

Reported By: \_\_\_\_\_

Terminal Identification: \_\_\_\_\_



Power problem.

Is the power cord plugged into a good outlet?

|   |  |   |
|---|--|---|
| <p><input type="checkbox"/> <b>Encoder/Reader</b></p> <p>CHECK light comes on when:</p> <p><input type="checkbox"/> Any document is read.</p> <p><input type="checkbox"/> Any document is encoded.</p> <p>Problem is:</p> <p><input type="checkbox"/> Documents won't pass through the read slot.</p> <p><input type="checkbox"/> No system response when document is passed through read slot.</p> | <p><input type="checkbox"/> <b>Display Screen</b></p> <p>Nothing displays — screen is:</p> <p><input type="checkbox"/> Completely blank.</p> <p><input type="checkbox"/> Filled with dots.</p> <p>Problem is:</p> <p><input type="checkbox"/> No cursor</p> <p><input type="checkbox"/> A line of dots across the screen.</p> <p>Character Problems:</p> <p><input type="checkbox"/> Characters are displayed in the wrong positions.</p> <p><input type="checkbox"/> Wrong characters are displayed.</p> <p><input type="checkbox"/> Partial characters are displayed.</p> <p><input type="checkbox"/> Characters contain extra dots.</p> | <p><input type="checkbox"/> <b>Keyboard</b></p> <p>CHECK light comes on when:</p> <p><input type="checkbox"/> Pressing only one or certain keys. They are: _____</p> <p><input type="checkbox"/> Pressing any key.</p> <p>Problem is:</p> <p><input type="checkbox"/> CHECK light is always on.</p> <p><input type="checkbox"/> All keys fail.</p> <p><input type="checkbox"/> One block of keys fail:</p> <p style="margin-left: 20px;"><input type="checkbox"/> Alpha</p> <p style="margin-left: 20px;"><input type="checkbox"/> Numeric</p> <p style="margin-left: 20px;"><input type="checkbox"/> Special</p> |
| <p><b>Control Operator Command(s) Fail</b></p> <p><input type="checkbox"/> 044    <input type="checkbox"/> _____</p>  | <p><input type="checkbox"/> 020    <input type="checkbox"/> 021    <input type="checkbox"/> 023</p> <p><input type="checkbox"/> 025    <input type="checkbox"/> 048    <input type="checkbox"/> 069</p>  | <p><input type="checkbox"/> 024    <input type="checkbox"/> 028</p> <p><input type="checkbox"/> 069</p>   |

## Loop Problem

Check the boxes that describe the condition of the lights listed for your loop.

|            |       | TEST UNIT Switch Not Pressed |                                   |                              | TEST UNIT Switch Pressed    |          |                              |                             |      |                              |
|------------|-------|------------------------------|-----------------------------------|------------------------------|-----------------------------|----------|------------------------------|-----------------------------|------|------------------------------|
| Loop Speed | Other | ☀️ READY:                    | <input type="checkbox"/> Flashing | <input type="checkbox"/> Off | <input type="checkbox"/> On | ☀️ READY | <input type="checkbox"/> Off | <input type="checkbox"/> On |      |                              |
|            | 600   | ☀️ READY:                    | <input type="checkbox"/> Flashing | <input type="checkbox"/> Off | <input type="checkbox"/> On | ☀️ 1     | <input type="checkbox"/> Off | <input type="checkbox"/> On | ☀️ 2 | <input type="checkbox"/> Off |

Problem is described below.

Address comments concerning this form to  
IBM Corporation, SCD, Dept. 52L  
Neighborhood Road, Kingston, N.Y. 12401

GX27-2959-2 U/M 025\*  
Printed in U.S.A.

\*No. of forms per pad may vary slightly

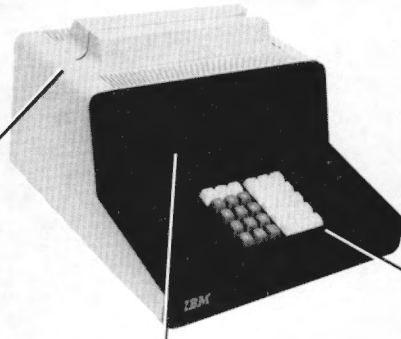
# 3604 Problem Report

Check the box next to the failing function and all statements that accurately describe the problem.

Date and Time: \_\_\_\_\_

Reported By: \_\_\_\_\_

Terminal Identification: \_\_\_\_\_



Power problem.

Is the power cord plugged into a good outlet?

|   |  |   |
|---|--|---|
| <p><input type="checkbox"/> <b>Encoder/Reader</b></p> <p>CHECK light comes on when:</p> <p><input type="checkbox"/> Any document is read.</p> <p><input type="checkbox"/> Any document is encoded.</p> <p>Problem is:</p> <p><input type="checkbox"/> Documents won't pass through the read slot.</p> <p><input type="checkbox"/> No system response when document is passed through read slot.</p> | <p><input type="checkbox"/> <b>Display Screen</b></p> <p>Nothing displays – screen is:</p> <p><input type="checkbox"/> Completely blank.</p> <p><input type="checkbox"/> Filled with dots.</p> <p>Problem is:</p> <p><input type="checkbox"/> No cursor</p> <p><input type="checkbox"/> A line of dots across the screen.</p> <p>Character Problems:</p> <p><input type="checkbox"/> Characters are displayed in the wrong positions.</p> <p><input type="checkbox"/> Wrong characters are displayed.</p> <p><input type="checkbox"/> Partial characters are displayed.</p> <p><input type="checkbox"/> Characters contain extra dots.</p> | <p><input type="checkbox"/> <b>Keyboard</b></p> <p>CHECK light comes on when:</p> <p><input type="checkbox"/> Pressing only one or certain keys. They are: _____</p> <p><input type="checkbox"/> Pressing any key.</p> <p>Problem is:</p> <p><input type="checkbox"/> CHECK light is always on.</p> <p><input type="checkbox"/> All keys fail.</p> <p><input type="checkbox"/> One block of keys fail:</p> <p style="margin-left: 20px;"><input type="checkbox"/> Alpha</p> <p style="margin-left: 20px;"><input type="checkbox"/> Numeric</p> <p style="margin-left: 20px;"><input type="checkbox"/> Special</p> |
| <p><b>Control Operator Command(s) Fail</b></p> <p><input type="checkbox"/> 044    <input type="checkbox"/> _____</p>  |  | <p><input type="checkbox"/> 020    <input type="checkbox"/> 021    <input type="checkbox"/> 023</p> <p><input type="checkbox"/> 025    <input type="checkbox"/> 048    <input type="checkbox"/> 069</p> <p><input type="checkbox"/> 024    <input type="checkbox"/> 028</p> <p><input type="checkbox"/> 069</p>   |

## Loop Problem

Check the boxes that describe the condition of the lights listed for your loop.

|            |       | TEST UNIT Switch Not Pressed |                                   |                              |                             | TEST UNIT Switch Pressed |                              |                             |  |
|------------|-------|------------------------------|-----------------------------------|------------------------------|-----------------------------|--------------------------|------------------------------|-----------------------------|--|
| Loop Speed | Other | ⊗ READY:                     | <input type="checkbox"/> Flashing | <input type="checkbox"/> Off | <input type="checkbox"/> On | ⊗ READY                  | <input type="checkbox"/> Off | <input type="checkbox"/> On |  |
|            | 600   | ⊗ READY:                     | <input type="checkbox"/> Flashing | <input type="checkbox"/> Off | <input type="checkbox"/> On | ⊗ 1                      | <input type="checkbox"/> Off | <input type="checkbox"/> On | ⊗ 2 <input type="checkbox"/> Off <input type="checkbox"/> On |

Problem is described below.

Address comments concerning this form to IBM Corporation, SCD, Dept. 52L, Neighborhood Road, Kingston, N.Y. 12401

GX27-2959-2 U/M 025\*  
Printed in U.S.A.

\*No. of forms per pad may vary slightly

This page precedes the 3610 Problem Report sheets.

# 3610 Problem Report

Check the box next to the failing function and all statements that accurately describe the problem.

Date and Time: \_\_\_\_\_

Reported By: \_\_\_\_\_

Terminal Identification: \_\_\_\_\_



Power problem.

Is the power cord plugged into a good outlet?

## Forms Problem

### JOURNAL ROLL OR CONTINUOUS FORMS

- Not feeding at all
- Feeds all the time
- Not linespacing correctly
- Won't load properly
- Tearing or jamming
- Does not stop at end-of-forms

### CUT FORMS

- Cannot insert
- Won't release after printing
- Not being gripped

## Printing Problem

### PRINT OPERATION

- Print line starts or stops in wrong column
- Prints wrong number of characters per line
- Left or right margin is uneven
- Wrong or missing characters
- STOP PRINT switch does not stop print operation
- Light or poor quality printing
- Certain characters won't print. They are:  
\_\_\_\_\_

### PRINT UNIT

- Does not move
- Moves but does not print
- Does not return to left
- Does not stop at end of transaction

### PRINT WHEEL

- Does not turn when START PRINT switch is pressed
- Will not stop turning
- Is broken

## Control Operator Command(s) Fail

- 020     021     023     025     066     069

Problem is described below.

Address comments concerning this form to  
IBM Corporation, SCD, Dept. 52L  
Neighborhood Road, Kingston, N.Y. 12401

GX27-2960-2 U/M 025\*  
Printed in U.S.A.

\*No. of forms per pad may vary slightly



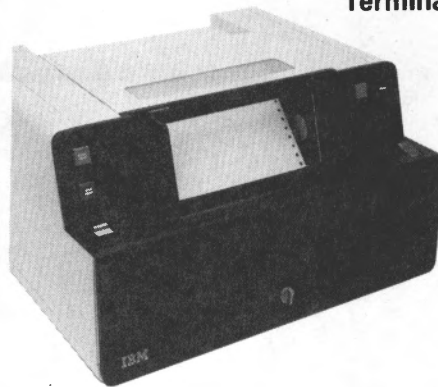
# 3610 Problem Report

Check the box next to the failing function and all statements that accurately describe the problem.

Date and Time: \_\_\_\_\_

Reported By: \_\_\_\_\_

Terminal Identification: \_\_\_\_\_



Power problem.

Is the power cord plugged into a good outlet?

## Forms Problem

### JOURNAL ROLL OR CONTINUOUS FORMS

- Not feeding at all
- Feeds all the time
- Not linespacing correctly
- Won't load properly
- Tearing or jamming
- Does not stop at end-of-forms

### CUT FORMS

- Cannot insert
- Won't release after printing
- Not being gripped

## Printing Problem

### PRINT OPERATION

- Print line starts or stops in wrong column
- Prints wrong number of characters per line
- Left or right margin is uneven
- Wrong or missing characters
- STOP PRINT switch does not stop print operation
- Light or poor quality printing
- Certain characters won't print. They are:  
\_\_\_\_\_

### PRINT UNIT

- Does not move
- Moves but does not print
- Does not return to left
- Does not stop at end of transaction

### PRINT WHEEL

- Does not turn when START PRINT switch is pressed
- Will not stop turning
- Is broken

## Control Operator Command(s) Fail

- 020     021     023     025     066     069

Problem is described below.

Address comments concerning this form to  
IBM Corporation, SCD, Dept. 52L  
Neighborhood Road, Kingston, N.Y. 12401

GX27-2960-2 U/M 025\*  
Printed in U.S.A.

\*No. of forms per pad may vary slightly

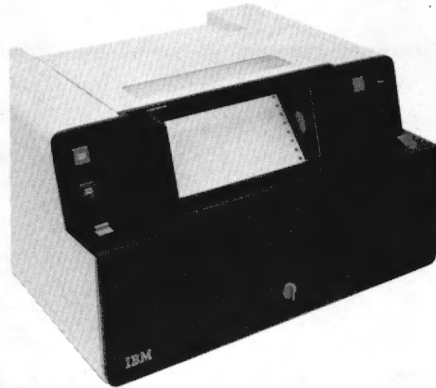
# 3610 Problem Report

Check the box next to the failing function and all statements that accurately describe the problem.

Date and Time: \_\_\_\_\_

Reported By: \_\_\_\_\_

Terminal Identification: \_\_\_\_\_



Power problem.

Is the power cord plugged into a good outlet?

## Forms Problem

### JOURNAL ROLL OR CONTINUOUS FORMS

- Not feeding at all
- Feeds all the time
- Not linespacing correctly
- Won't load properly
- Tearing or jamming
- Does not stop at end-of-forms

### CUT FORMS

- Cannot insert
- Won't release after printing
- Not being gripped

## Printing Problem

### PRINT OPERATION

- Print line starts or stops in wrong column
- Prints wrong number of characters per line
- Left or right margin is uneven
- Wrong or missing characters
- STOP PRINT switch does not stop print operation
- Light or poor quality printing
- Certain characters won't print. They are:  
\_\_\_\_\_

### PRINT UNIT

- Does not move
- Moves but does not print
- Does not return to left
- Does not stop at end of transaction

### PRINT WHEEL

- Does not turn when START PRINT switch is pressed
- Will not stop turning
- Is broken

## Control Operator Command(s) Fail

- 020     021     023     025     066     069

Problem is described below.

Address comments concerning this form to  
IBM Corporation, SCD, Dept. 52L  
Neighborhood Road, Kingston, N.Y. 12401

GX27-2960-2 U/M 025\*  
Printed in U.S.A.

\*No. of forms per pad may vary slightly

This page precedes the 3611 Problem Report sheets.

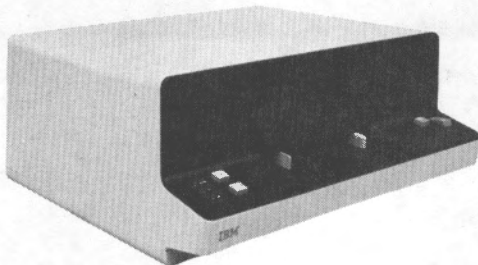
# 3611 Problem Report

Check the box next to the failing function and all statements that accurately describe the problem.

Date and Time: \_\_\_\_\_

Reported By: \_\_\_\_\_

Terminal Identification: \_\_\_\_\_



Power problem.

Is the power cord plugged into a good outlet?

|   |  |  |  |
|---|--|--|--|
| <p><b>Forms Problem</b></p> <p><input type="checkbox"/> Cut Forms</p> <ul style="list-style-type: none"> <li><input type="checkbox"/> Cannot insert</li> <li><input type="checkbox"/> Won't release after printing</li> <li><input type="checkbox"/> Not being gripped</li> <li><input type="checkbox"/> Jams</li> </ul>  | <p><b>Passbook Insertion Problem</b></p> <ul style="list-style-type: none"> <li><input type="checkbox"/> Cannot insert</li> <li><input type="checkbox"/> Won't release after printing.</li> <li><input type="checkbox"/> Not being gripped</li> <li><input type="checkbox"/> Jams</li> </ul>   |  |  |
| <p><b>Printing Problem</b></p> <table style="width: 100%;"> <tr> <td style="width: 50%; vertical-align: top; padding: 5px;"> <p><b>PRINT OPERATION</b></p> <ul style="list-style-type: none"> <li><input type="checkbox"/> Print line starts or stops in wrong column</li> <li><input type="checkbox"/> Prints wrong number of characters per line</li> <li><input type="checkbox"/> Left or right margin is uneven</li> <li><input type="checkbox"/> Wrong or missing characters</li> <li><input type="checkbox"/> STOP PRINT switch does not stop print operation</li> <li><input type="checkbox"/> Light or poor quality printing</li> <li><input type="checkbox"/> Certain characters won't print. They are:<br/>_____</li> </ul> </td> <td style="width: 50%; vertical-align: top; padding: 5px;"> <p><b>PRINT UNIT</b></p> <ul style="list-style-type: none"> <li><input type="checkbox"/> Does not move</li> <li><input type="checkbox"/> Moves but does not print</li> <li><input type="checkbox"/> Does not return to left</li> <li><input type="checkbox"/> Does not stop at end of transaction</li> </ul> <p><b>PRINT WHEEL</b></p> <ul style="list-style-type: none"> <li><input type="checkbox"/> Does not turn when START PRINT switch is pressed</li> <li><input type="checkbox"/> Will not stop turning</li> <li><input type="checkbox"/> Is broken</li> </ul> </td> </tr> </table> |  | <p><b>PRINT OPERATION</b></p> <ul style="list-style-type: none"> <li><input type="checkbox"/> Print line starts or stops in wrong column</li> <li><input type="checkbox"/> Prints wrong number of characters per line</li> <li><input type="checkbox"/> Left or right margin is uneven</li> <li><input type="checkbox"/> Wrong or missing characters</li> <li><input type="checkbox"/> STOP PRINT switch does not stop print operation</li> <li><input type="checkbox"/> Light or poor quality printing</li> <li><input type="checkbox"/> Certain characters won't print. They are:<br/>_____</li> </ul> | <p><b>PRINT UNIT</b></p> <ul style="list-style-type: none"> <li><input type="checkbox"/> Does not move</li> <li><input type="checkbox"/> Moves but does not print</li> <li><input type="checkbox"/> Does not return to left</li> <li><input type="checkbox"/> Does not stop at end of transaction</li> </ul> <p><b>PRINT WHEEL</b></p> <ul style="list-style-type: none"> <li><input type="checkbox"/> Does not turn when START PRINT switch is pressed</li> <li><input type="checkbox"/> Will not stop turning</li> <li><input type="checkbox"/> Is broken</li> </ul> |
| <p><b>PRINT OPERATION</b></p> <ul style="list-style-type: none"> <li><input type="checkbox"/> Print line starts or stops in wrong column</li> <li><input type="checkbox"/> Prints wrong number of characters per line</li> <li><input type="checkbox"/> Left or right margin is uneven</li> <li><input type="checkbox"/> Wrong or missing characters</li> <li><input type="checkbox"/> STOP PRINT switch does not stop print operation</li> <li><input type="checkbox"/> Light or poor quality printing</li> <li><input type="checkbox"/> Certain characters won't print. They are:<br/>_____</li> </ul>  | <p><b>PRINT UNIT</b></p> <ul style="list-style-type: none"> <li><input type="checkbox"/> Does not move</li> <li><input type="checkbox"/> Moves but does not print</li> <li><input type="checkbox"/> Does not return to left</li> <li><input type="checkbox"/> Does not stop at end of transaction</li> </ul> <p><b>PRINT WHEEL</b></p> <ul style="list-style-type: none"> <li><input type="checkbox"/> Does not turn when START PRINT switch is pressed</li> <li><input type="checkbox"/> Will not stop turning</li> <li><input type="checkbox"/> Is broken</li> </ul> |  |  |
| <p><b>Control Operator Command(s) Fail</b></p> <p style="text-align: center;"> <input type="checkbox"/> 020    <input type="checkbox"/> 021    <input type="checkbox"/> 023    <input type="checkbox"/> 025    <input type="checkbox"/> 066    <input type="checkbox"/> 069         </p>  |  |  |  |

Problem is described below.

Address comments concerning this form to  
 IBM Corporation, SCD, Dept. 52L  
 Neighborhood Road, Kingston, N.Y. 12401

GX27-2977-1 U/M 025\*  
 Printed in U.S.A.

\*No. of forms per pad may vary slightly

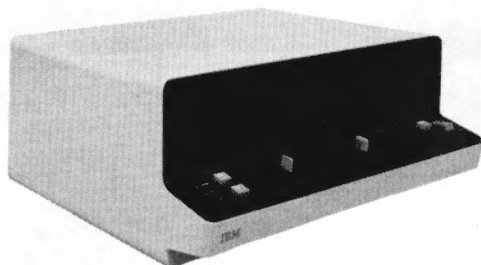
# 3611 Problem Report

Check the box next to the failing function and all statements that accurately describe the problem.

Date and Time: \_\_\_\_\_

Reported By: \_\_\_\_\_

Terminal Identification: \_\_\_\_\_



Power problem.

Is the power cord plugged into a good outlet?

|   |  |  |  |
|---|--|--|--|
| <p><b>Forms Problem</b></p> <p><input type="checkbox"/> Cut Forms</p> <ul style="list-style-type: none"> <li><input type="checkbox"/> Cannot insert</li> <li><input type="checkbox"/> Won't release after printing</li> <li><input type="checkbox"/> Not being gripped</li> <li><input type="checkbox"/> Jams</li> </ul>  | <p><b>Passbook Insertion Problem</b></p> <ul style="list-style-type: none"> <li><input type="checkbox"/> Cannot insert</li> <li><input type="checkbox"/> Won't release after printing.</li> <li><input type="checkbox"/> Not being gripped</li> <li><input type="checkbox"/> Jams</li> </ul>   |  |  |
| <p><b>Printing Problem</b></p> <table style="width: 100%;"> <tr> <td style="width: 50%; vertical-align: top; padding: 5px;"> <p><b>PRINT OPERATION</b></p> <ul style="list-style-type: none"> <li><input type="checkbox"/> Print line starts or stops in/wrong column</li> <li><input type="checkbox"/> Prints wrong number of characters per line</li> <li><input type="checkbox"/> Left or right margin is uneven</li> <li><input type="checkbox"/> Wrong or missing characters</li> <li><input type="checkbox"/> STOP PRINT switch does not stop print operation</li> <li><input type="checkbox"/> Light or poor quality printing</li> <li><input type="checkbox"/> Certain characters won't print. They are:<br/>_____</li> </ul> </td> <td style="width: 50%; vertical-align: top; padding: 5px;"> <p><b>PRINT UNIT</b></p> <ul style="list-style-type: none"> <li><input type="checkbox"/> Does not move</li> <li><input type="checkbox"/> Moves but does not print</li> <li><input type="checkbox"/> Does not return to left</li> <li><input type="checkbox"/> Does not stop at end of transaction</li> </ul> <p><b>PRINT WHEEL</b></p> <ul style="list-style-type: none"> <li><input type="checkbox"/> Does not turn when START PRINT switch is pressed</li> <li><input type="checkbox"/> Will not stop turning</li> <li><input type="checkbox"/> Is broken</li> </ul> </td> </tr> </table> |  | <p><b>PRINT OPERATION</b></p> <ul style="list-style-type: none"> <li><input type="checkbox"/> Print line starts or stops in/wrong column</li> <li><input type="checkbox"/> Prints wrong number of characters per line</li> <li><input type="checkbox"/> Left or right margin is uneven</li> <li><input type="checkbox"/> Wrong or missing characters</li> <li><input type="checkbox"/> STOP PRINT switch does not stop print operation</li> <li><input type="checkbox"/> Light or poor quality printing</li> <li><input type="checkbox"/> Certain characters won't print. They are:<br/>_____</li> </ul> | <p><b>PRINT UNIT</b></p> <ul style="list-style-type: none"> <li><input type="checkbox"/> Does not move</li> <li><input type="checkbox"/> Moves but does not print</li> <li><input type="checkbox"/> Does not return to left</li> <li><input type="checkbox"/> Does not stop at end of transaction</li> </ul> <p><b>PRINT WHEEL</b></p> <ul style="list-style-type: none"> <li><input type="checkbox"/> Does not turn when START PRINT switch is pressed</li> <li><input type="checkbox"/> Will not stop turning</li> <li><input type="checkbox"/> Is broken</li> </ul> |
| <p><b>PRINT OPERATION</b></p> <ul style="list-style-type: none"> <li><input type="checkbox"/> Print line starts or stops in/wrong column</li> <li><input type="checkbox"/> Prints wrong number of characters per line</li> <li><input type="checkbox"/> Left or right margin is uneven</li> <li><input type="checkbox"/> Wrong or missing characters</li> <li><input type="checkbox"/> STOP PRINT switch does not stop print operation</li> <li><input type="checkbox"/> Light or poor quality printing</li> <li><input type="checkbox"/> Certain characters won't print. They are:<br/>_____</li> </ul>  | <p><b>PRINT UNIT</b></p> <ul style="list-style-type: none"> <li><input type="checkbox"/> Does not move</li> <li><input type="checkbox"/> Moves but does not print</li> <li><input type="checkbox"/> Does not return to left</li> <li><input type="checkbox"/> Does not stop at end of transaction</li> </ul> <p><b>PRINT WHEEL</b></p> <ul style="list-style-type: none"> <li><input type="checkbox"/> Does not turn when START PRINT switch is pressed</li> <li><input type="checkbox"/> Will not stop turning</li> <li><input type="checkbox"/> Is broken</li> </ul> |  |  |
| <p><b>Control Operator Command(s) Fail</b></p> <p style="text-align: center;"> <input type="checkbox"/> 020    <input type="checkbox"/> 021    <input type="checkbox"/> 023    <input type="checkbox"/> 025    <input type="checkbox"/> 066    <input type="checkbox"/> 069         </p>  |  |  |  |

Problem is described below.

Address comments concerning this form to  
 IBM Corporation, SCD, Dept. 52L  
 Neighborhood Road, Kingston, N.Y. 12401

GX27-2977-1 U/M 025\*  
 Printed in U.S.A.

\*No. of forms per pad may vary slightly

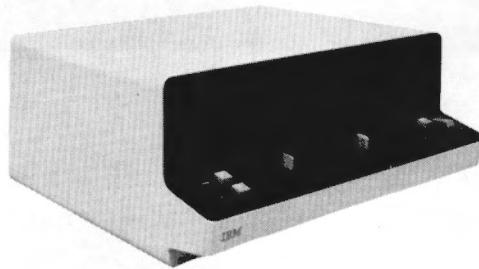
# 3611 Problem Report

Check the box next to the failing function and all statements that accurately describe the problem.

Date and Time: \_\_\_\_\_

Reported By: \_\_\_\_\_

Terminal Identification: \_\_\_\_\_



Power problem.

Is the power cord plugged into a good outlet?

|   |  |  |  |
|---|--|--|--|
| <p><b>Forms Problem</b></p> <p><input type="checkbox"/> Cut Forms</p> <ul style="list-style-type: none"> <li><input type="checkbox"/> Cannot insert</li> <li><input type="checkbox"/> Won't release after printing</li> <li><input type="checkbox"/> Not being gripped</li> <li><input type="checkbox"/> Jams</li> </ul>  | <p><b>Passbook Insertion Problem</b></p> <ul style="list-style-type: none"> <li><input type="checkbox"/> Cannot insert</li> <li><input type="checkbox"/> Won't release after printing.</li> <li><input type="checkbox"/> Not being gripped</li> <li><input type="checkbox"/> Jams</li> </ul>   |  |  |
| <p><b>Printing Problem</b></p> <table style="width: 100%;"> <tr> <td style="width: 50%; vertical-align: top; padding: 5px;"> <p><b>PRINT OPERATION</b></p> <ul style="list-style-type: none"> <li><input type="checkbox"/> Print line starts or stops in wrong column</li> <li><input type="checkbox"/> Prints wrong number of characters per line</li> <li><input type="checkbox"/> Left or right margin is uneven</li> <li><input type="checkbox"/> Wrong or missing characters</li> <li><input type="checkbox"/> STOP PRINT switch does not stop print operation</li> <li><input type="checkbox"/> Light or poor quality printing</li> <li><input type="checkbox"/> Certain characters won't print. They are:<br/>_____</li> </ul> </td> <td style="width: 50%; vertical-align: top; padding: 5px;"> <p><b>PRINT UNIT</b></p> <ul style="list-style-type: none"> <li><input type="checkbox"/> Does not move</li> <li><input type="checkbox"/> Moves but does not print</li> <li><input type="checkbox"/> Does not return to left</li> <li><input type="checkbox"/> Does not stop at end of transaction</li> </ul> <p><b>PRINT WHEEL</b></p> <ul style="list-style-type: none"> <li><input type="checkbox"/> Does not turn when START PRINT switch is pressed</li> <li><input type="checkbox"/> Will not stop turning</li> <li><input type="checkbox"/> Is broken</li> </ul> </td> </tr> </table> |  | <p><b>PRINT OPERATION</b></p> <ul style="list-style-type: none"> <li><input type="checkbox"/> Print line starts or stops in wrong column</li> <li><input type="checkbox"/> Prints wrong number of characters per line</li> <li><input type="checkbox"/> Left or right margin is uneven</li> <li><input type="checkbox"/> Wrong or missing characters</li> <li><input type="checkbox"/> STOP PRINT switch does not stop print operation</li> <li><input type="checkbox"/> Light or poor quality printing</li> <li><input type="checkbox"/> Certain characters won't print. They are:<br/>_____</li> </ul> | <p><b>PRINT UNIT</b></p> <ul style="list-style-type: none"> <li><input type="checkbox"/> Does not move</li> <li><input type="checkbox"/> Moves but does not print</li> <li><input type="checkbox"/> Does not return to left</li> <li><input type="checkbox"/> Does not stop at end of transaction</li> </ul> <p><b>PRINT WHEEL</b></p> <ul style="list-style-type: none"> <li><input type="checkbox"/> Does not turn when START PRINT switch is pressed</li> <li><input type="checkbox"/> Will not stop turning</li> <li><input type="checkbox"/> Is broken</li> </ul> |
| <p><b>PRINT OPERATION</b></p> <ul style="list-style-type: none"> <li><input type="checkbox"/> Print line starts or stops in wrong column</li> <li><input type="checkbox"/> Prints wrong number of characters per line</li> <li><input type="checkbox"/> Left or right margin is uneven</li> <li><input type="checkbox"/> Wrong or missing characters</li> <li><input type="checkbox"/> STOP PRINT switch does not stop print operation</li> <li><input type="checkbox"/> Light or poor quality printing</li> <li><input type="checkbox"/> Certain characters won't print. They are:<br/>_____</li> </ul>  | <p><b>PRINT UNIT</b></p> <ul style="list-style-type: none"> <li><input type="checkbox"/> Does not move</li> <li><input type="checkbox"/> Moves but does not print</li> <li><input type="checkbox"/> Does not return to left</li> <li><input type="checkbox"/> Does not stop at end of transaction</li> </ul> <p><b>PRINT WHEEL</b></p> <ul style="list-style-type: none"> <li><input type="checkbox"/> Does not turn when START PRINT switch is pressed</li> <li><input type="checkbox"/> Will not stop turning</li> <li><input type="checkbox"/> Is broken</li> </ul> |  |  |
| <p><b>Control Operator Command(s) Fail</b></p> <p style="text-align: center;"> <input type="checkbox"/> 020    <input type="checkbox"/> 021    <input type="checkbox"/> 023    <input type="checkbox"/> 025    <input type="checkbox"/> 066    <input type="checkbox"/> 069         </p>  |  |  |  |

Problem is described below.

Address comments concerning this form to  
IBM Corporation, SCD, Dept. 52L  
Neighborhood Road, Kingston, N.Y. 12401

GX27-2977-1 U/M 025\*

Printed in U.S.A.

\*No. of forms per pad may vary slightly

This page precedes the 3612 Problem Report sheets.



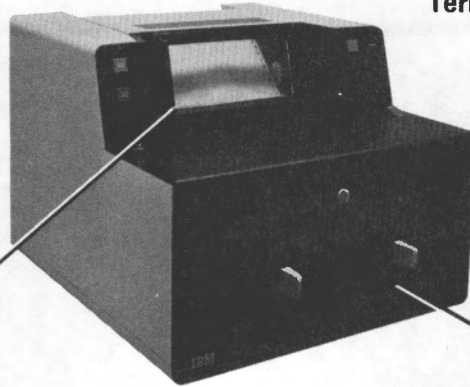
# 3612 Problem Report

Check the box next to the failing function and all statements that accurately describe the problem.

Date and Time: \_\_\_\_\_

Reported By: \_\_\_\_\_

Terminal Identification: \_\_\_\_\_



Power problem.

Is the power cord plugged into a good outlet?

Document Printer

Passbook Printer

### Forms Problem

- Journal Roll or Continuous Forms
- Not feeding at all
  - Feeds all the time
  - Not linespacing correctly
  - Won't load properly
  - Tearing or jamming
  - Does not stop at end-of-forms

- Cut Forms
- Cannot insert
  - Won't release after printing
  - Not being gripped

### Passbook Insertion Problem

- Cannot insert
- Won't release after printing
- Not being gripped
- Jams

### Printing Problem

- Passbook Printer       Document Printer

#### PRINT OPERATION

- Print line starts or stops in wrong column
- Prints wrong number of characters per line
- Left or right margin is uneven
- Wrong or missing characters
- STOP PRINT switch does not stop print operation
- Light or poor quality printing
- Certain characters won't print. They are:  
\_\_\_\_\_

#### PRINT UNIT

- Does not move
- Moves but does not print
- Does not return to left
- Does not stop at end of transaction

#### PRINT WHEEL

- Does not turn when START PRINT switch is pressed
- Will not stop turning
- Is broken

### Control Operator Command(s) Fail

- Passbook Printer       020       021       023       025       066       069  
 Document Printer

Problem is described below.

Address comments concerning this form to  
IBM Corporation, SCD, Dept. 52L  
Neighborhood Road, Kingston, N.Y. 12401

GX27-2961-2 U/M 025\*  
Printed in U.S.A.

\*No. of forms per pad may vary slightly

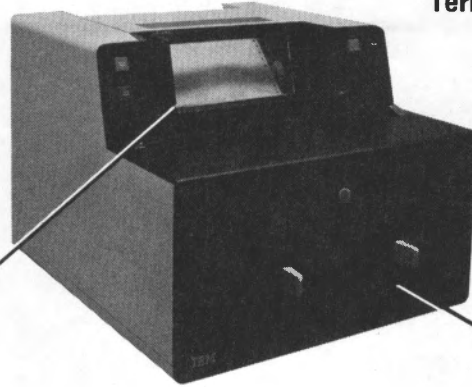
# 3612 Problem Report

Check the box next to the failing function and all statements that accurately describe the problem.

Date and Time: \_\_\_\_\_

Reported By: \_\_\_\_\_

Terminal Identification: \_\_\_\_\_



Power problem.

Is the power cord plugged into a good outlet?

Document Printer

Passbook Printer

### Forms Problem

- Journal Roll or Continuous Forms
- Not feeding at all
  - Feeds all the time
  - Not linespacing correctly
  - Won't load properly
  - Tearing or jamming
  - Does not stop at end-of-forms

- Cut Forms
- Cannot insert
  - Won't release after printing
  - Not being gripped

### Passbook Insertion Problem

- Cannot insert
- Won't release after printing
- Not being gripped
- Jams

### Printing Problem

- Passbook Printer     Document Printer

#### PRINT OPERATION

- Print line starts or stops in wrong column
- Prints wrong number of characters per line
- Left or right margin is uneven
- Wrong or missing characters
- STOP PRINT switch does not stop print operation
- Light or poor quality printing
- Certain characters won't print. They are:  
\_\_\_\_\_

#### PRINT UNIT

- Does not move
- Moves but does not print
- Does not return to left
- Does not stop at end of transaction

#### PRINT WHEEL

- Does not turn when START PRINT switch is pressed
- Will not stop turning
- Is broken

### Control Operator Command(s) Fail

- Passbook Printer     020     021     023     025     066     069  
 Document Printer

Problem is described below.

Address comments concerning this form to  
IBM Corporation, SCD, Dept. 52L  
Neighborhood Road, Kingston, N.Y. 12401

GX27-2961-2 U/M 025\*  
Printed in U.S.A.

\*No. of forms per pad may vary slightly

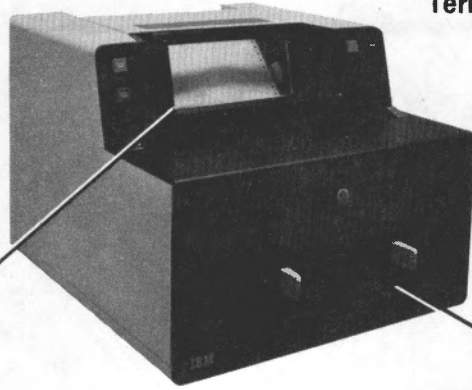
# 3612 Problem Report

Check the box next to the failing function and all statements that accurately describe the problem.

Date and Time: \_\_\_\_\_

Reported By: \_\_\_\_\_

Terminal Identification: \_\_\_\_\_



Power problem.

Is the power cord plugged into a good outlet?

Document Printer

Passbook Printer

### Forms Problem

- Journal Roll or Continuous Forms
- Not feeding at all
  - Feeds all the time
  - Not linespacing correctly
  - Won't load properly
  - Tearing or jamming
  - Does not stop at end-of-forms

- Cut Forms
- Cannot insert
  - Won't release after printing
  - Not being gripped

### Passbook Insertion Problem

- Cannot insert
- Won't release after printing
- Not being gripped
- Jams

### Printing Problem

- Passbook Printer     Document Printer

#### PRINT OPERATION

- Print line starts or stops in wrong column
- Prints wrong number of characters per line
- Left or right margin is uneven
- Wrong or missing characters
- STOP PRINT switch does not stop print operation
- Light or poor quality printing
- Certain characters won't print. They are:  
\_\_\_\_\_

#### PRINT UNIT

- Does not move
- Moves but does not print
- Does not return to left
- Does not stop at end of transaction

#### PRINT WHEEL

- Does not turn when START PRINT switch is pressed
- Will not stop turning
- Is broken

### Control Operator Command(s) Fail

- Passbook Printer     020     021     023     025     066     069  
 Document Printer

Problem is described below.

Address comments concerning this form to  
IBM Corporation, SCD, Dept. 52L  
Neighborhood Road, Kingston, N.Y. 12401

GX27-2961-2 U/M 025\*  
Printed in U.S.A.

\*No. of forms per pad may vary slightly

This page precedes the 3618 Problem Report sheets.

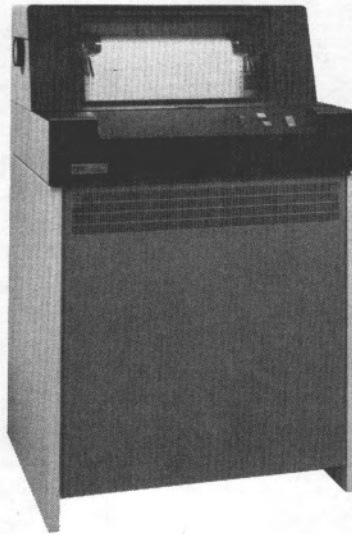
# 3618 Problem Report

Check the box next to the failing function and all statements that accurately describe the problem.

Date and Time: \_\_\_\_\_

Reported By: \_\_\_\_\_

Terminal Identification: \_\_\_\_\_



Power problem.

Is the power cord plugged into a good outlet?

Abnormal noise

|   |  |  |  |
|---|--|--|--|
| <p><b>Forms Problem</b></p> <p><input type="checkbox"/> Forms loading</p> <p><input type="checkbox"/> Not linespacing correctly</p> <p><input type="checkbox"/> Forms do not feed</p> <p><input type="checkbox"/> Forms feed all the time</p> <p><input type="checkbox"/> Tearing or jamming</p>  | <p><b>Ribbon Problem</b></p> <p><input type="checkbox"/> Ribbon not feeding</p> <p><input type="checkbox"/> Cassette won't load</p> <p><input type="checkbox"/> Ribbon feeds all the time</p> <p><input type="checkbox"/> Ribbon tangles</p>                                     |  |  |
| <p><b>Printing Problem</b></p> <table style="width: 100%;"> <tr> <td style="width: 50%; vertical-align: top;"> <p><input type="checkbox"/> Nothing prints</p> <p><input type="checkbox"/> Print line starts or stops at the wrong location</p> <p><input type="checkbox"/> Stops printing before a line is completed</p> <p><input type="checkbox"/> Prints immediately when power is turned on</p> </td> <td style="width: 50%; vertical-align: top;"> <p><input type="checkbox"/> Wrong or missing characters</p> <p><input type="checkbox"/> Prints wrong number of characters per line</p> <p><input type="checkbox"/> Print quality is poor</p> <p><input type="checkbox"/> Certain characters won't print. They are:<br/>_____</p> </td> </tr> </table> |  | <p><input type="checkbox"/> Nothing prints</p> <p><input type="checkbox"/> Print line starts or stops at the wrong location</p> <p><input type="checkbox"/> Stops printing before a line is completed</p> <p><input type="checkbox"/> Prints immediately when power is turned on</p> | <p><input type="checkbox"/> Wrong or missing characters</p> <p><input type="checkbox"/> Prints wrong number of characters per line</p> <p><input type="checkbox"/> Print quality is poor</p> <p><input type="checkbox"/> Certain characters won't print. They are:<br/>_____</p> |
| <p><input type="checkbox"/> Nothing prints</p> <p><input type="checkbox"/> Print line starts or stops at the wrong location</p> <p><input type="checkbox"/> Stops printing before a line is completed</p> <p><input type="checkbox"/> Prints immediately when power is turned on</p>  | <p><input type="checkbox"/> Wrong or missing characters</p> <p><input type="checkbox"/> Prints wrong number of characters per line</p> <p><input type="checkbox"/> Print quality is poor</p> <p><input type="checkbox"/> Certain characters won't print. They are:<br/>_____</p> |  |  |
| <p><b>Control Operator Command(s) Fail</b></p> <p><input type="checkbox"/> 020    <input type="checkbox"/> 021    <input type="checkbox"/> 023    <input type="checkbox"/> 025    <input type="checkbox"/> 069</p>  |  |  |  |

Problem is described below.

Address comments concerning this form to  
IBM Corporation, SCD, Dept. 52L  
Neighborhood Road, Kingston, N.Y. 12401

GX27-2962-1 U/M 025\*  
Printed in U.S.A.

\*No. of forms per pad may vary slightly

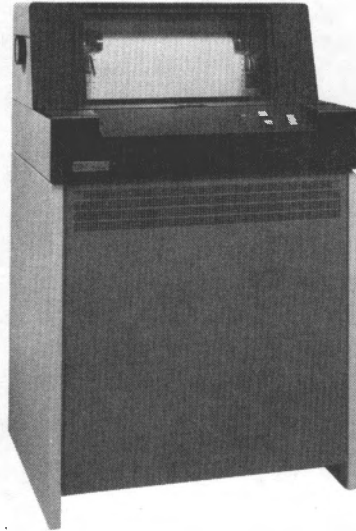
# 3618 Problem Report

Check the box next to the failing function and all statements that accurately describe the problem.

Date and Time: \_\_\_\_\_

Reported By: \_\_\_\_\_

Terminal Identification: \_\_\_\_\_



Power problem.

Is the power cord plugged into a good outlet?

Abnormal noise

|  |   |  |   |
|--|---|--|---|
| <p><b>Forms Problem</b></p> <p><input type="checkbox"/> Forms loading</p> <p><input type="checkbox"/> Not linespacing correctly</p> <p><input type="checkbox"/> Forms do not feed</p> <p><input type="checkbox"/> Forms feed all the time</p> <p><input type="checkbox"/> Tearing or jamming</p>   | <p><b>Ribbon Problem</b></p> <p><input type="checkbox"/> Ribbon not feeding</p> <p><input type="checkbox"/> Cassette won't load</p> <p><input type="checkbox"/> Ribbon feeds all the time</p> <p><input type="checkbox"/> Ribbon tangles</p>  |  |   |
| <p><b>Printing Problem</b></p> <table style="width: 100%;"> <tr> <td style="width: 50%; vertical-align: top;"> <p><input type="checkbox"/> Nothing prints</p> <p><input type="checkbox"/> Print line starts or stops at the wrong location</p> <p><input type="checkbox"/> Stops printing before a line is completed</p> <p><input type="checkbox"/> Prints immediately when power is turned on</p> </td> <td style="width: 50%; vertical-align: top;"> <p><input type="checkbox"/> Wrong or missing characters</p> <p><input type="checkbox"/> Prints wrong number of characters per line</p> <p><input type="checkbox"/> Print quality is poor</p> <p><input type="checkbox"/> Certain characters won't print. They are:</p> <p style="text-align: center;">_____</p> </td> </tr> </table> |   | <p><input type="checkbox"/> Nothing prints</p> <p><input type="checkbox"/> Print line starts or stops at the wrong location</p> <p><input type="checkbox"/> Stops printing before a line is completed</p> <p><input type="checkbox"/> Prints immediately when power is turned on</p> | <p><input type="checkbox"/> Wrong or missing characters</p> <p><input type="checkbox"/> Prints wrong number of characters per line</p> <p><input type="checkbox"/> Print quality is poor</p> <p><input type="checkbox"/> Certain characters won't print. They are:</p> <p style="text-align: center;">_____</p> |
| <p><input type="checkbox"/> Nothing prints</p> <p><input type="checkbox"/> Print line starts or stops at the wrong location</p> <p><input type="checkbox"/> Stops printing before a line is completed</p> <p><input type="checkbox"/> Prints immediately when power is turned on</p>   | <p><input type="checkbox"/> Wrong or missing characters</p> <p><input type="checkbox"/> Prints wrong number of characters per line</p> <p><input type="checkbox"/> Print quality is poor</p> <p><input type="checkbox"/> Certain characters won't print. They are:</p> <p style="text-align: center;">_____</p> |  |   |
| <p><b>Control Operator Command(s) Fail</b></p> <p><input type="checkbox"/> 020    <input type="checkbox"/> 021    <input type="checkbox"/> 023    <input type="checkbox"/> 025    <input type="checkbox"/> 069</p>   |   |  |   |

Problem is described below.

Address comments concerning this form to  
 IBM Corporation, SCD, Dept. 52L  
 Neighborhood Road, Kingston, N.Y. 12401

GX27-2962-1 U/M 025\*  
 Printed in U.S.A.

\*No. of forms per pad may vary slightly



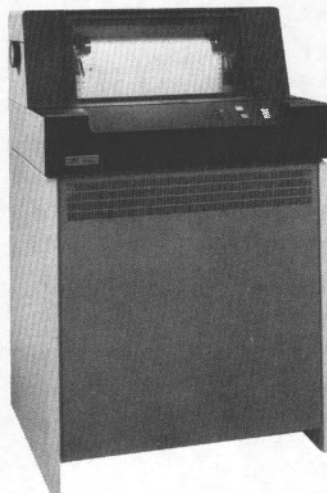
# 3618 Problem Report

Check the box next to the failing function and all statements that accurately describe the problem.

Date and Time: \_\_\_\_\_

Reported By: \_\_\_\_\_

Terminal Identification: \_\_\_\_\_



Power problem.

Is the power cord plugged into a good outlet?

Abnormal noise

|  |   |  |   |
|--|---|--|---|
| <p><b>Forms Problem</b></p> <p><input type="checkbox"/> Forms loading</p> <p><input type="checkbox"/> Not linespacing correctly</p> <p><input type="checkbox"/> Forms do not feed</p> <p><input type="checkbox"/> Forms feed all the time</p> <p><input type="checkbox"/> Tearing or jamming</p>   | <p><b>Ribbon Problem</b></p> <p><input type="checkbox"/> Ribbon not feeding</p> <p><input type="checkbox"/> Cassette won't load</p> <p><input type="checkbox"/> Ribbon feeds all the time</p> <p><input type="checkbox"/> Ribbon tangles</p>  |  |   |
| <p><b>Printing Problem</b></p> <table style="width: 100%;"> <tr> <td style="vertical-align: top;"> <p><input type="checkbox"/> Nothing prints</p> <p><input type="checkbox"/> Print line starts or stops at the wrong location</p> <p><input type="checkbox"/> Stops printing before a line is completed</p> <p><input type="checkbox"/> Prints immediately when power is turned on</p> </td> <td style="vertical-align: top;"> <p><input type="checkbox"/> Wrong or missing characters</p> <p><input type="checkbox"/> Prints wrong number of characters per line</p> <p><input type="checkbox"/> Print quality is poor</p> <p><input type="checkbox"/> Certain characters won't print. They are:</p> <p>_____</p> </td> </tr> </table> |   | <p><input type="checkbox"/> Nothing prints</p> <p><input type="checkbox"/> Print line starts or stops at the wrong location</p> <p><input type="checkbox"/> Stops printing before a line is completed</p> <p><input type="checkbox"/> Prints immediately when power is turned on</p> | <p><input type="checkbox"/> Wrong or missing characters</p> <p><input type="checkbox"/> Prints wrong number of characters per line</p> <p><input type="checkbox"/> Print quality is poor</p> <p><input type="checkbox"/> Certain characters won't print. They are:</p> <p>_____</p> |
| <p><input type="checkbox"/> Nothing prints</p> <p><input type="checkbox"/> Print line starts or stops at the wrong location</p> <p><input type="checkbox"/> Stops printing before a line is completed</p> <p><input type="checkbox"/> Prints immediately when power is turned on</p>   | <p><input type="checkbox"/> Wrong or missing characters</p> <p><input type="checkbox"/> Prints wrong number of characters per line</p> <p><input type="checkbox"/> Print quality is poor</p> <p><input type="checkbox"/> Certain characters won't print. They are:</p> <p>_____</p> |  |   |
| <p><b>Control Operator Command(s) Fail</b></p> <p><input type="checkbox"/> 020    <input type="checkbox"/> 021    <input type="checkbox"/> 023    <input type="checkbox"/> 025    <input type="checkbox"/> 069</p>   |   |  |   |

Problem is described below.

Address comments concerning this form to  
 IBM Corporation, SCD, Dept. 52L  
 Neighborhood Road, Kingston, N.Y. 12401

**Problem Recovery**

GX27-2962-1 U/M 025\*  
 Printed in U.S.A.

\*No. of forms per pad may vary slightly

**Problem Report Sheets**



## **Contents – Installation Details**

Loop Speed and Address Switches

Supplies

Installation Reference Sheets

    General

    Local Loop Description Sheets

    Single-Location Remote Loop Description Sheets

    Multi-Location Remote Loop Description Sheets

    Remote Loop Location Directory

This page follows the Installation Details tab.




This page precedes the Installation Details, Loop Speed and Address Switches page 1.




## Loop Speed and Address Switches

Each terminal (except the 3614, whose speed and address are fixed) has two groups of switches. Group 1 is used to set the terminal address (*not* the work station address), and group 2 is used to set the terminal to the loop speed. The 3606-1 and 3608-1 have one additional group of switches for the sub-address, permitting several units to share a terminal address. All the terminals on a loop must be set to the same speed (and must match the speed of the loop to which they are attached); however, each terminal or terminal group on a loop must have a different terminal address.

Each group of switches has four switches, labeled 1 to 4 or, for the sub-address, 5 to 8. Table 1 shows the settings of the address switches for each terminal address, Table 2 shows the settings of the loop speed switches for each loop speed, and Table 3 shows the settings of subaddress switches for each subaddress.

The switches are located in different places for different terminals. On a 3604, they are located on the bottom of the terminal; to get at them, you must tip up the 3604. On the 3606 and 3608, they are located under the display filter. On the 3610, 3611, 3612, and 3618 printers, the switches are located inside the printer. Figure 1 shows the location of the loop speed and address switches for these terminals. Some units use the symbol 

to indicate the group 1 (terminal address) switches and the symbol  to indicate the group 2 (loop speed) switches.

**Table 1. Terminal Address (Group 1) Switch Settings**

| Terminal Address | Switch     |            |
|------------------|------------|------------|
|                  | ON         | OFF        |
| 0                | —          | 1, 2, 3, 4 |
| 1                | 1          | 2, 3, 4    |
| 2                | 2          | 1, 3, 4    |
| 3                | 1, 2       | 3, 4       |
| 4                | 3          | 1, 2, 4    |
| 5                | 1, 3       | 2, 4       |
| 6                | 2, 3       | 1, 4       |
| 7                | 1, 2, 3    | 4          |
| 8                | 4          | 1, 2, 3    |
| 9                | 1, 4       | 2, 3       |
| 10               | 2, 4       | 1, 3       |
| 11               | 1, 2, 4    | 3          |
| 12               | 3, 4       | 1, 2       |
| 13               | 1, 3, 4    | 2          |
| 14               | 2, 3, 4    | 1          |
| 15               | 1, 2, 3, 4 | —          |

**Table 3. Subaddress (Group 3) Switch Settings**

| Sub-Address | Switch*    |         |
|-------------|------------|---------|
|             | ON         | OFF     |
| 0           | NOT VALID  |         |
| 1           | 5          | 6, 7, 8 |
| 2           | 6          | 5, 7, 8 |
| 3           | 5, 6       | 7, 8    |
| 4           | 7          | 5, 6, 8 |
| 5           | 5, 7       | 6, 8    |
| 6           | 6, 7       | 5, 8    |
| 7           | 5, 6, 7    | 8       |
| 8           | 8          | 5, 6, 7 |
| 9           | 5, 8       | 6, 7    |
| 10          | 6, 8       | 5, 7    |
| 11          | 5, 6, 8    | 7       |
| 12          | 7, 8       | 5, 6    |
| 13          | 5, 7, 8    | 6       |
| 14          | 6, 7, 8    | 5       |
| 15          | 5, 6, 7, 8 | —       |

\*The 3608 does not use switch 5; therefore, only even number sub-addresses are valid.

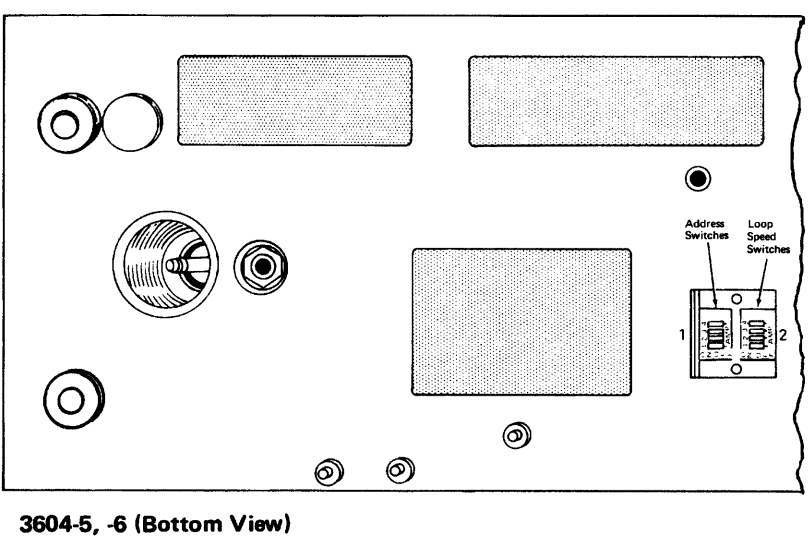
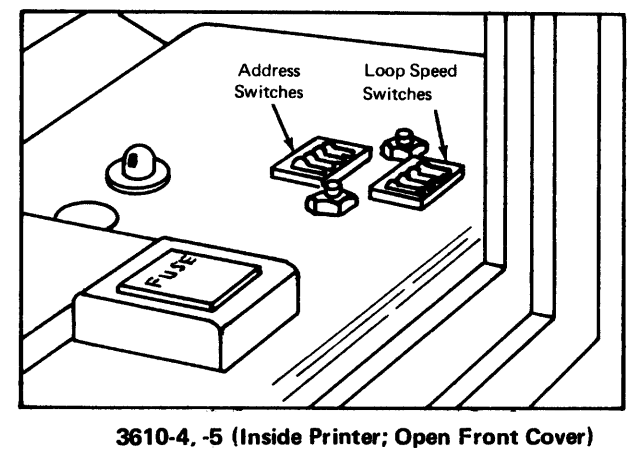
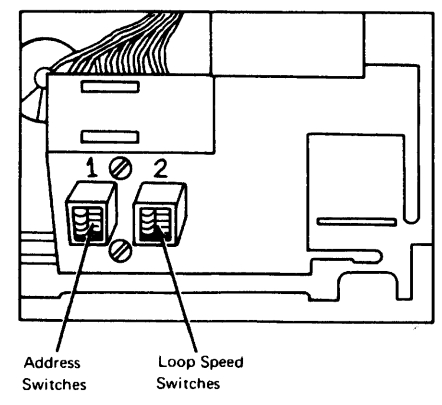
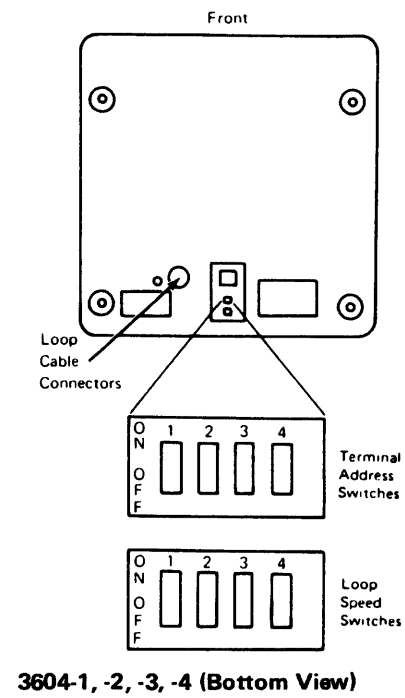
**Table 2. Loop Speed (Group 2) Switch Settings**

| Loop Speed* | Switch |         |
|-------------|--------|---------|
|             | ON     | OFF     |
| 600         | 1      | 2, 3, 4 |
| 1200        | 2      | 1, 3, 4 |
| 2400        | 3      | 1, 2, 4 |
| 4800**      | 4      | 1, 2, 3 |

\*Speed in bits-per-second.

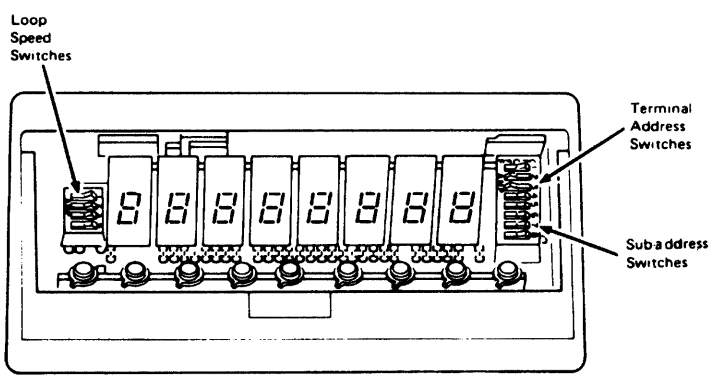
\*\*Local loops only.

**CAUTION: Only one loop speed switch should be on for any speed setting; more than one switch on will cause the terminal to malfunction.**



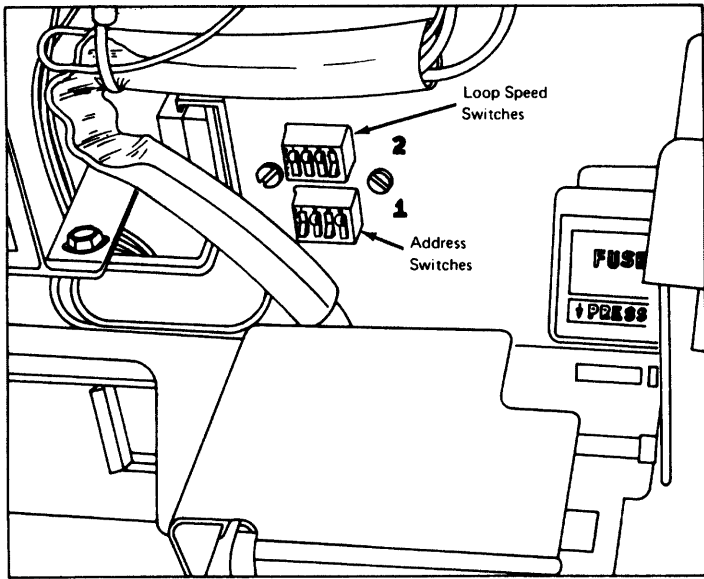
**A. 3604**

**C. 3610**

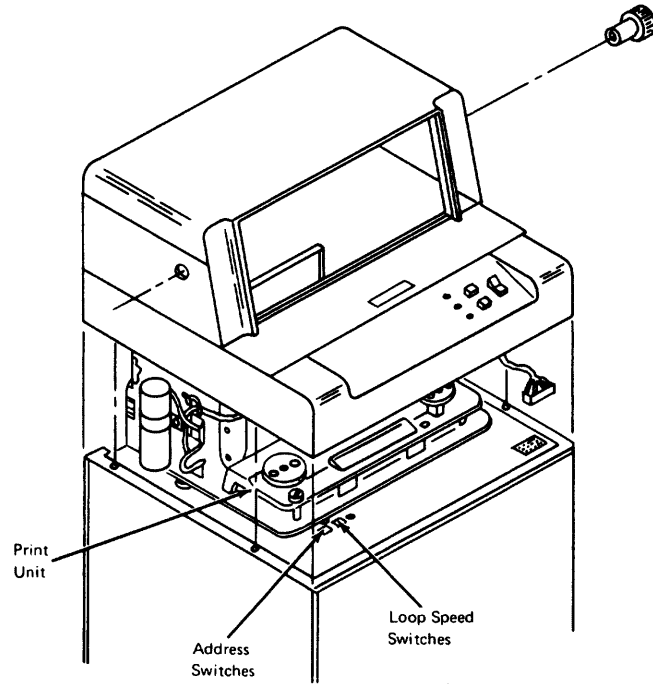


**Figure 1. Location of Loop Speed and Address Switches (Sheet 1 of 2)**

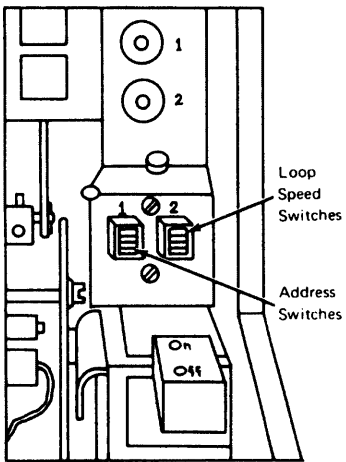




D. 3611 (Inside Printer; Lift Top Cover)



F. 3618 (Inside Printer; Lift Top Cover)



E. 3612 (Inside Printer; Lift Top Cover)

Figure 1. Location of Loop and Address Switches (Sheet 2 of 2)

This page precedes the Installation Details, Supplies page 1.



## Supplies

The supplies for the several 3600 system units are as follows:

| <i>Item</i>                             | <i>IBM Part Number</i> |
|---|------------------------|
| Controller diskette                     |                        |
| Formatted                               |                        |
| One-sided                               | 2305845                |
| Two-sided                               | 2736700                |
| Starter                                 | 1652106                |
| Test                                    | 4944351                |
| <br>                                    |                        |
| 3604 Keyboard Display                   |                        |
| Magnetic stripes (in rolls of 500)      | 428650                 |
| Keypop labels for Models 1 through 4:   |                        |
| Preprinted (group 1) *                  | 1561341                |
| Preprinted (group 2) *                  | 1561342                |
| Blank base for customization            | 1561332                |
| Clear protective overlay                | 1561333                |
| Set of above (1 each of 4)              | 1561360                |
| Overlays for Models 5 and 6:            |                        |
| 45-position                             | 4942506                |
| 15-position, numeric                    | 4942515                |
| Clear protective overlay                | 4943749                |
| <br>                                    |                        |
| 3606, 3608 Financial Services Terminals |                        |
| Display filter                          |                        |
| With standard nomenclature*             | 1702817                |
| Blank                                   | 1702904                |
| Keyboard overlay                        |                        |
| With standard nomenclature*             | 1702847                |
| With blanks for function keys           | 1702848                |
| Clear protective overlay                | 1702849                |
| Ink roll (3608 only)                    | 1816598                |
| Operator instruction label**            | N/A                    |
| <br>                                    |                        |
| 3610, 3611, 3612 Printers               |                        |
| Terminal and loop speed switch symbols  |                        |
| 3610, 3612                              | 4402755                |
| 3611                                    | 4402761                |
| Cleaning wheel                          | 1811470                |
| Ink roll (package of 4):                |                        |
| 15-cps (wiper not required)             | 432861                 |
| Up to 30-cps (includes wiper)           | 432860                 |
| <br>                                    |                        |
| 3614 Terminal                           |                        |
| Ink cartridge                           | 433894                 |
| <br>                                    |                        |
| 3618 Printer                            |                        |
| Ribbon cassette                         | 1136634                |

\*See next pages for examples of these items.

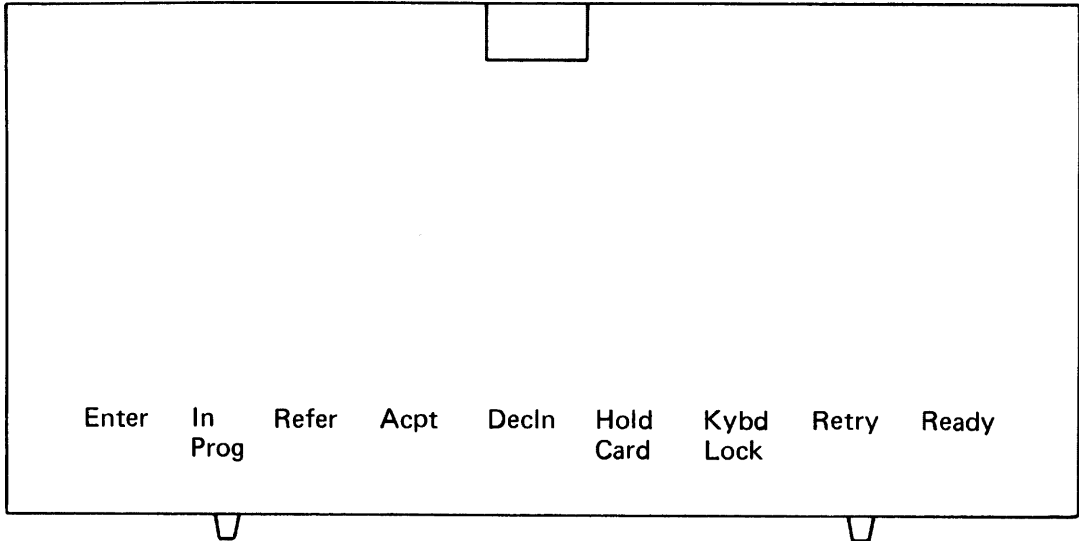
\*\*The operator instruction label is not available from IBM; see the *IBM 3600 Finance Communications System Installations Manual-Physical Planning*, GA27-2766, for details.

|               |              |                |       |              |               |               |              |               |                |
|---------------|--------------|----------------|-------|--------------|---------------|---------------|--------------|---------------|----------------|
| ABC           | DEF          | GHI            | JKL   | MNO          | PQR           | ST            | UVW          | XYZ           | AJ             |
| BKS           | CLT          | DMU            | ENV   | FOW          | GPX           | HQY           | IRZ          | Jan           | Feb            |
| Mar           | Apr          | May            | Jun   | Jul          | Aug           | Sep           | Oct          | Nov           | Dec            |
| \$            | #            | *              | +     | -            | /             | 7 Day         | 10 Day       | 20 Day        | 30 Day         |
| 10-30<br>Day  | Acct<br>No   | Addtl<br>Entry | Bal   | Bal<br>Fwd   | Bal<br>Inq    | Br Off        | Bond         | Bond<br>Redem | Check<br>Write |
| Close<br>Acct | Club<br>Pmnt | Comm           | Contl | Corr         | Cr            | Credit        | Date         | Debit         | Dep            |
| Dep<br>Corr   | Dep<br>Trsfr | Enter          | Dup   | Elec<br>Pmnt | Escrw<br>Pmnt | Escrw<br>Only | Fgn<br>Draft | Gas<br>Pmnt   | Govt<br>Check  |
| Hold          | Hold<br>Canc | Hold<br>Entry  | In    | Inq.         | Ins<br>Pmnt   | Int           | Int<br>Only  | Life<br>Ins   | List           |
| Loan<br>Pmnt  | Mail         | Minus<br>Corr  | Misc  | Misc<br>Cred | Misc<br>Debit | Misc<br>Dep   | Misc<br>Pmnt | Misc<br>Wdwl  | Money<br>Order |
| Mortg<br>Pmnt | New<br>Acct  | Old<br>Bal     | Other | Out          | Ovdrft        | Over<br>Ride  | Paid         | Paid<br>In    | Paid<br>Out    |

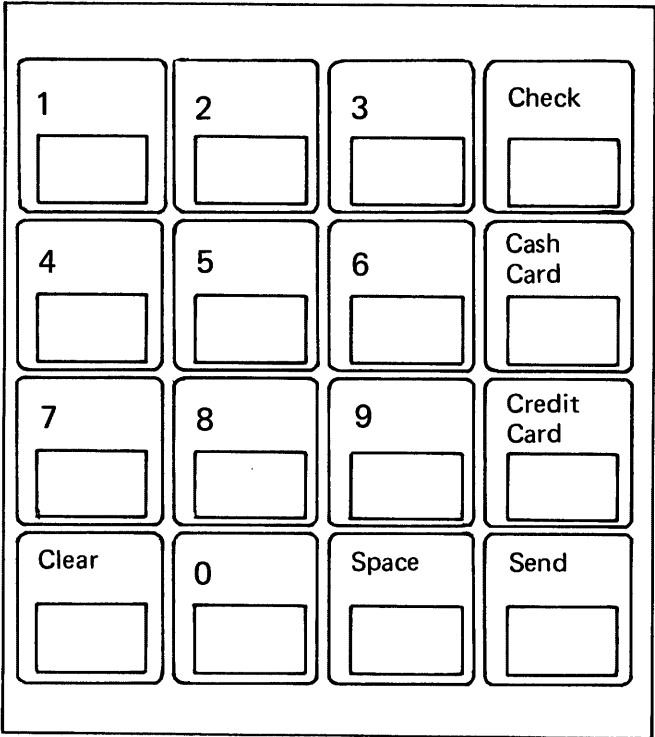
IBM PN 1561341 Preprinted Label, Group 1

|            |             |          |           |            |            |            |            |             |            |
|------------|-------------|----------|-----------|------------|------------|------------|------------|-------------|------------|
| Pay Roll   | Pmnt        | Pb Loan  | Plus Corr | Prev Date  | Princ Only | Rcpt       | Re-Entry   | Reg Check   | Re Purc    |
| School     | Spec Check  | Stop     | Sub Bal   | Tax        | Teller Chk | Trsfr      | TI Ck Mo   | Total       | Phone Pmnt |
| Cash Adv   | Sav         | Club     | Coml Loan | Instl Loan | CIF        | Bonus Sav  | CD         | Teller Cash | Adjust     |
| Journl     | Cash Item   | Draft    | Teller    | Clerk      | Audtr      | Supv       | Cr Cd Pmnt | Spl 1       | Spl 2      |
| Water Pmnt | Rntl Pmnt   | Late Chg | Maint     | Proof      | Mixed      | On Line    | Off Line   | Altn Date   | Intrm 1    |
| Intrm 2    | Trans Code  | Pay Back | Sell      | Close      | Redem      | Reglr      | Forgn      | (           | )          |
| Day        | Sub Bal     | Add      | Sub       | Mult       | Div        | +          | -          | X           | ÷          |
| =          | Eqls        | Valdt    | Cmplt     | Log On     | Log Off    | Prnt Inhbt | Prnt Rstr  | Page Fwd    | Page Bkwd  |
| Erase      | Bksp        | Reset    | Teller A  | Teller B   | Bond Sold  | Bond Value | Book       | Box Pmnt    | Canc       |
| Cash       | Cashr Check | Cash Dep | Cash In   | Cash Out   | Cert Check | Check      | Check Cash | Check Dep   | Check No   |

IBM PN 1561342 Preprinted Label, Group 2



**IBM PN 1702817 Display Filter**



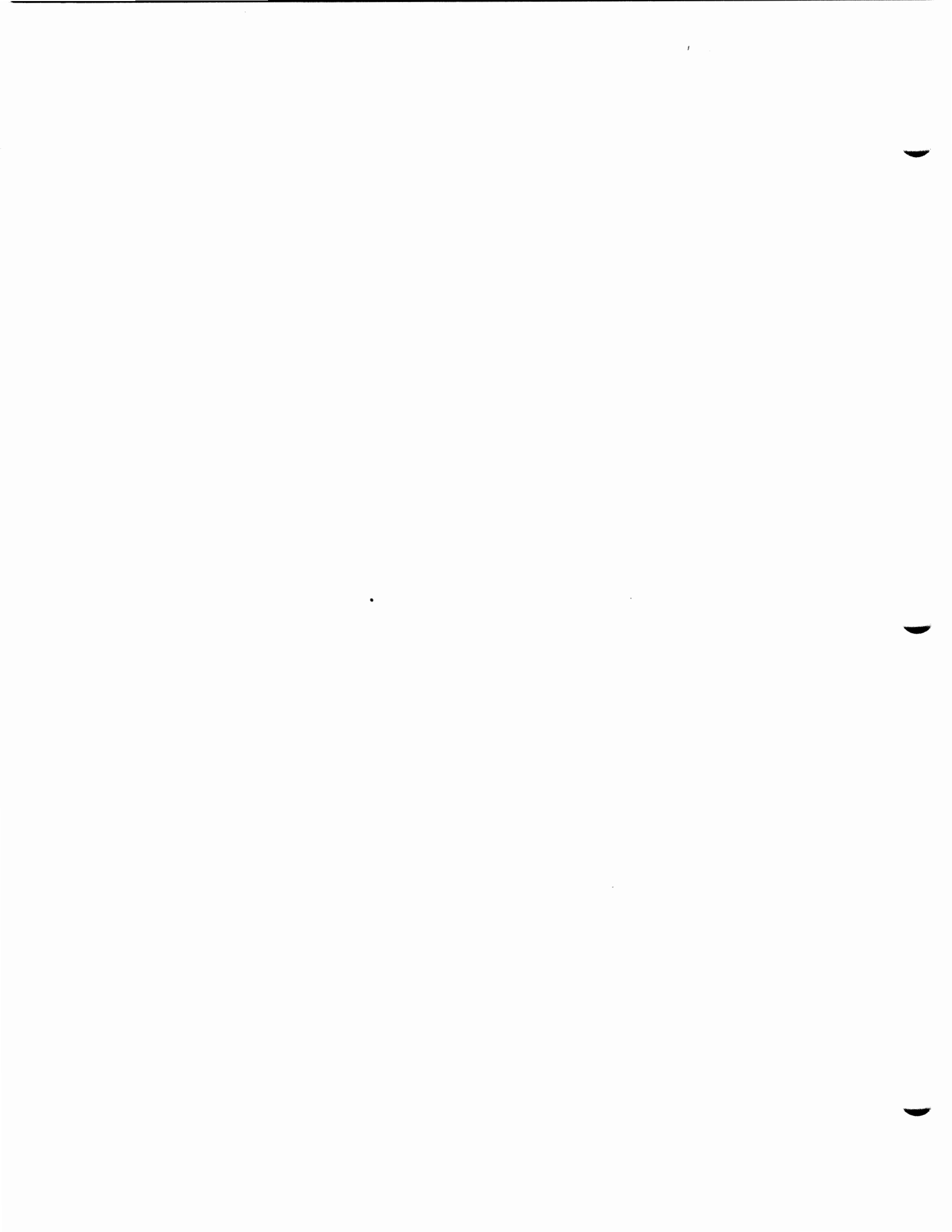
**IBM PN 1702847 Keyboard Overlay**



## Contents – Installation Reference Sheets

|  |    |
|--|----|
| General . . . . .  | 1  |
| Local Loop Description Sheets . . . . .                  | 3  |
| Single-Location Remote Loop Description Sheets . . . . . | 17 |
| Multi-Location Remote Loop Description Sheets . . . . .  | 29 |
| Remote Loop Location Directory . . . . .                 | 41 |

This page precedes the Installation Details, Installation Reference Sheets page 1.



Place all Installation Details pages after this tab.

## Installation Reference Sheets

### GENERAL

For many problems, you must know what terminals are attached to your loop and the physical order of the terminals on the loop. To help, this chapter contains installation reference sheets for you to fill out at installation time; the front of each sheet is a filled-in sample, the back is for you to fill out. The sheets are designed so that your institution can describe its unique installations. Four kinds of sheets are provided:

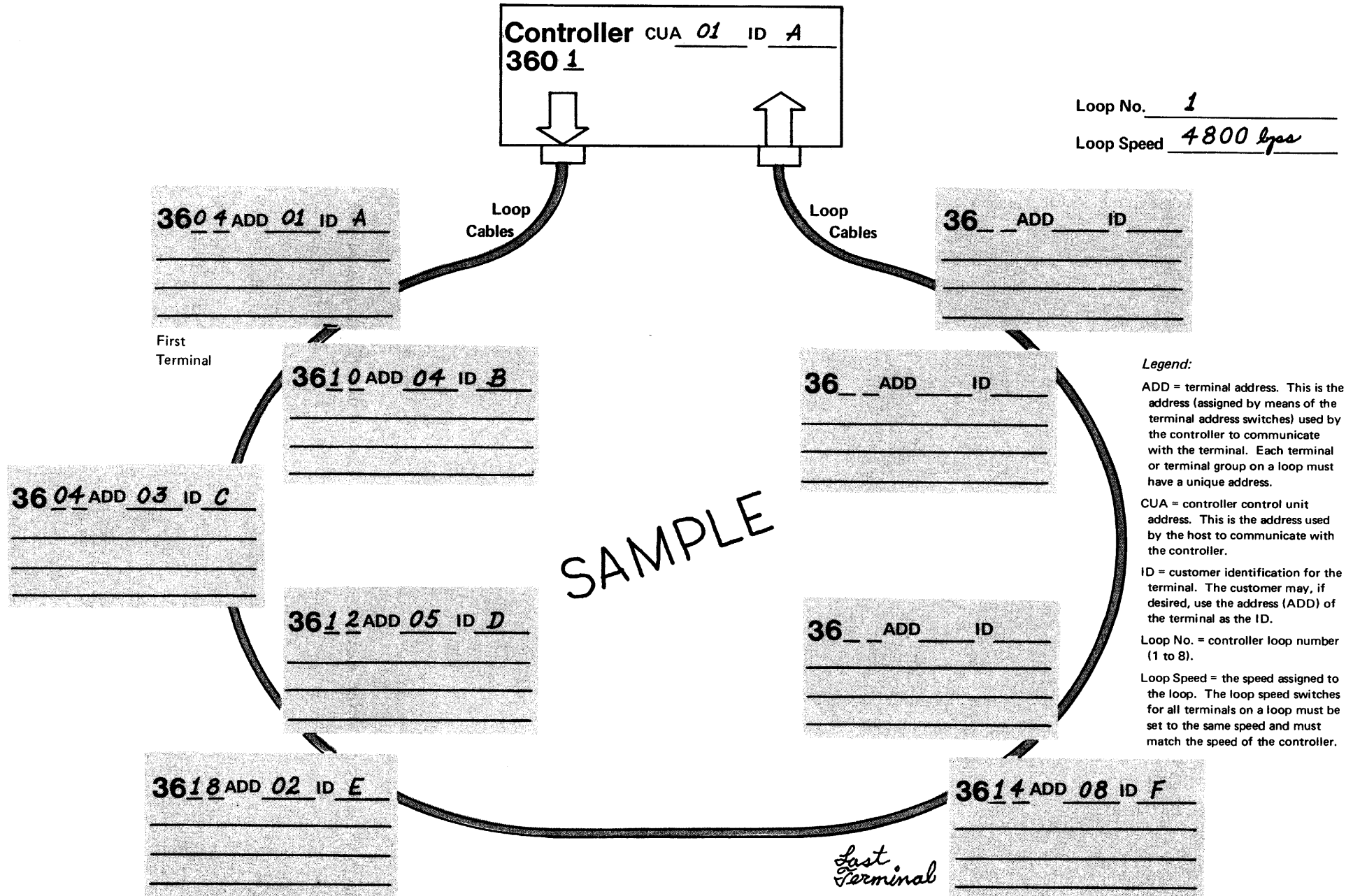
- Local Loop Description Sheet (seven are provided).
- Single-Location Remote Loop Description Sheet (six are provided).
- Multi-Location Remote Loop Description Sheet (six are provided).
- Remote Loop Location Directory (six are provided).

The first three kinds of sheets, when filled in, describe each loop's terminals, their addresses, their IDs, the work stations, and the physical order of the terminals on the loop. The Remote Loop Location Directory allows you to include information about the locations making up a remote loop.



This page precedes the Local Loop Description Sheets.

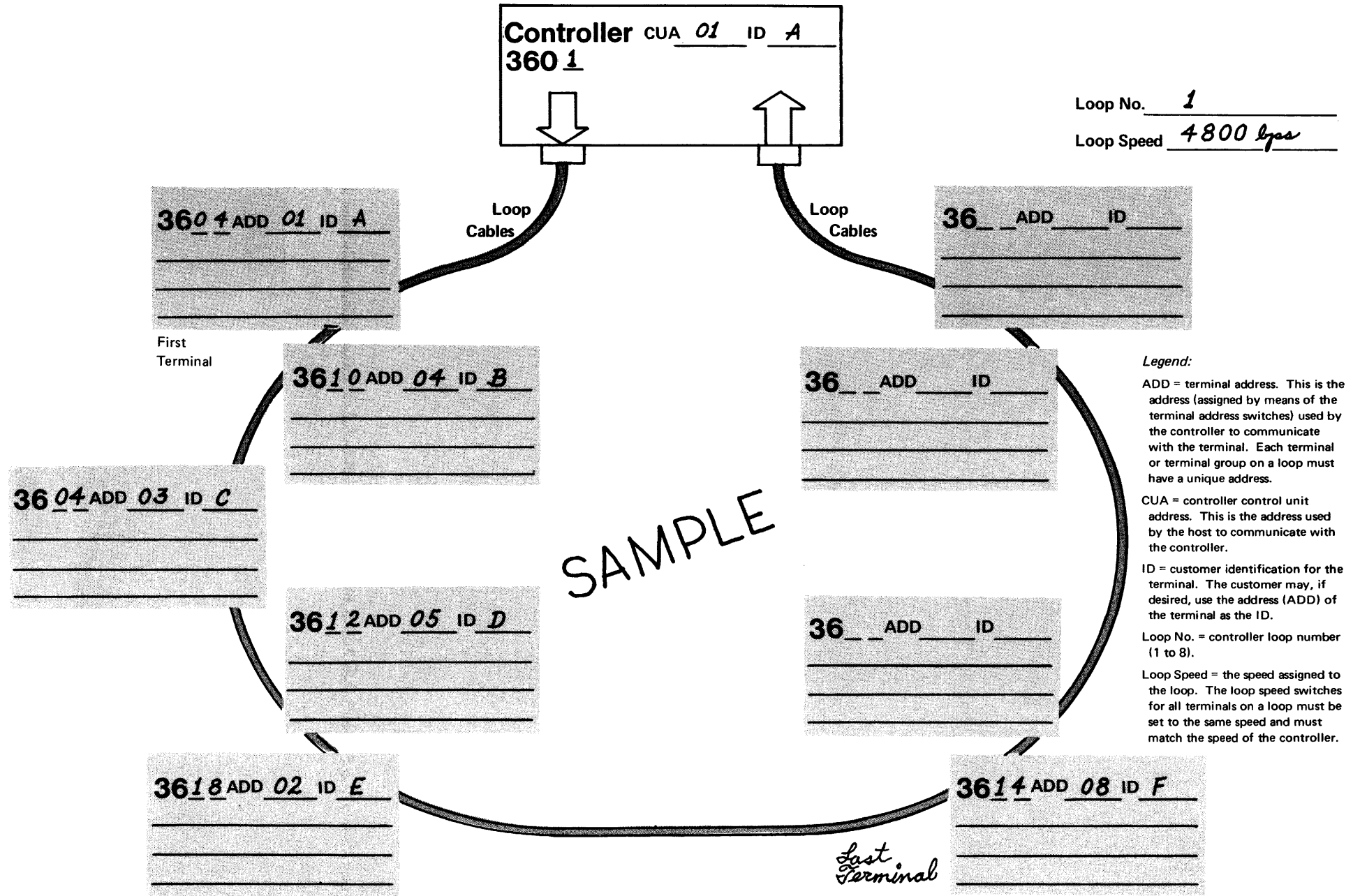




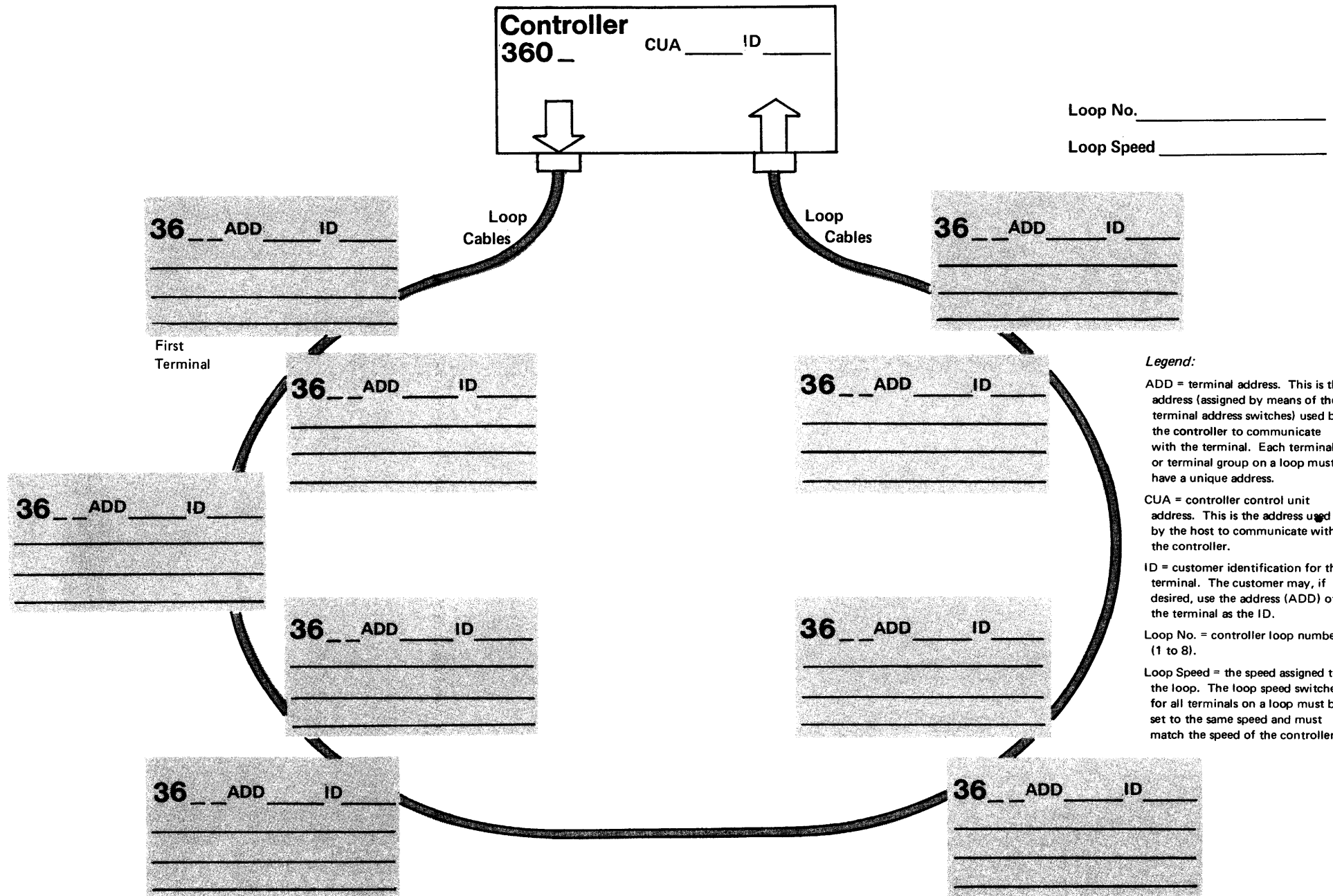
Local Loop Description Sheet



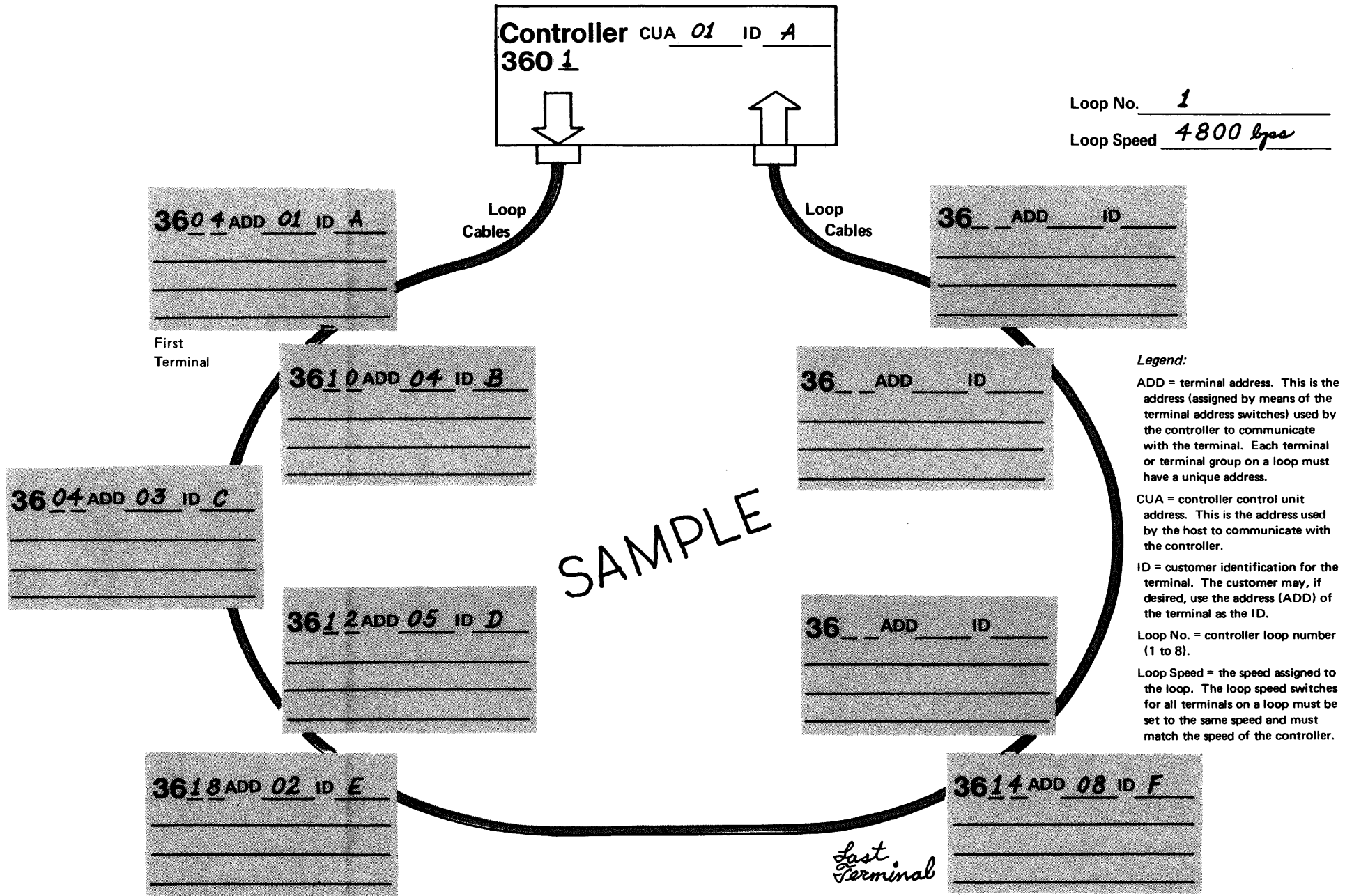




Local Loop Description Sheet



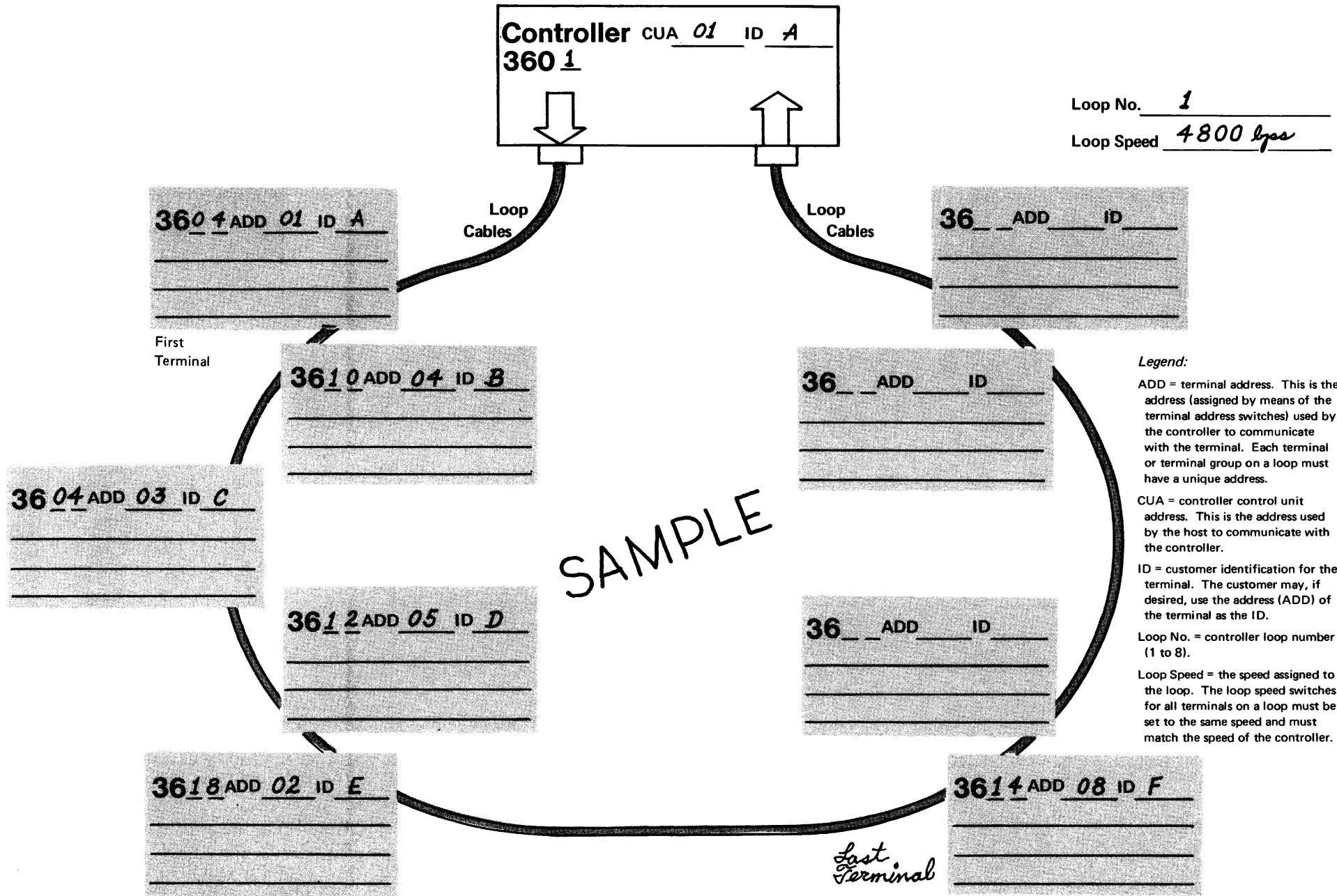
Local Loop Description Sheet



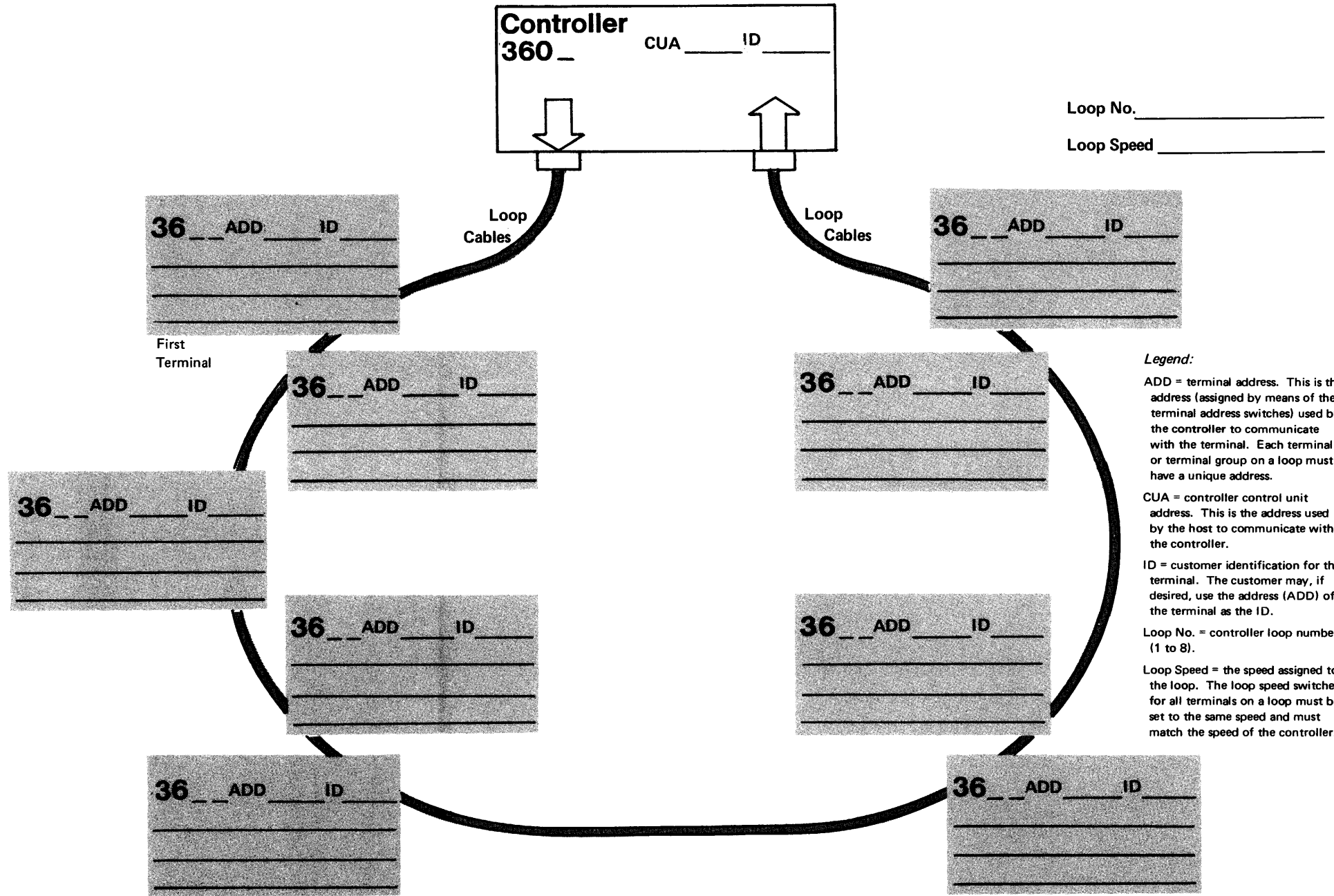
Local Loop Description Sheet



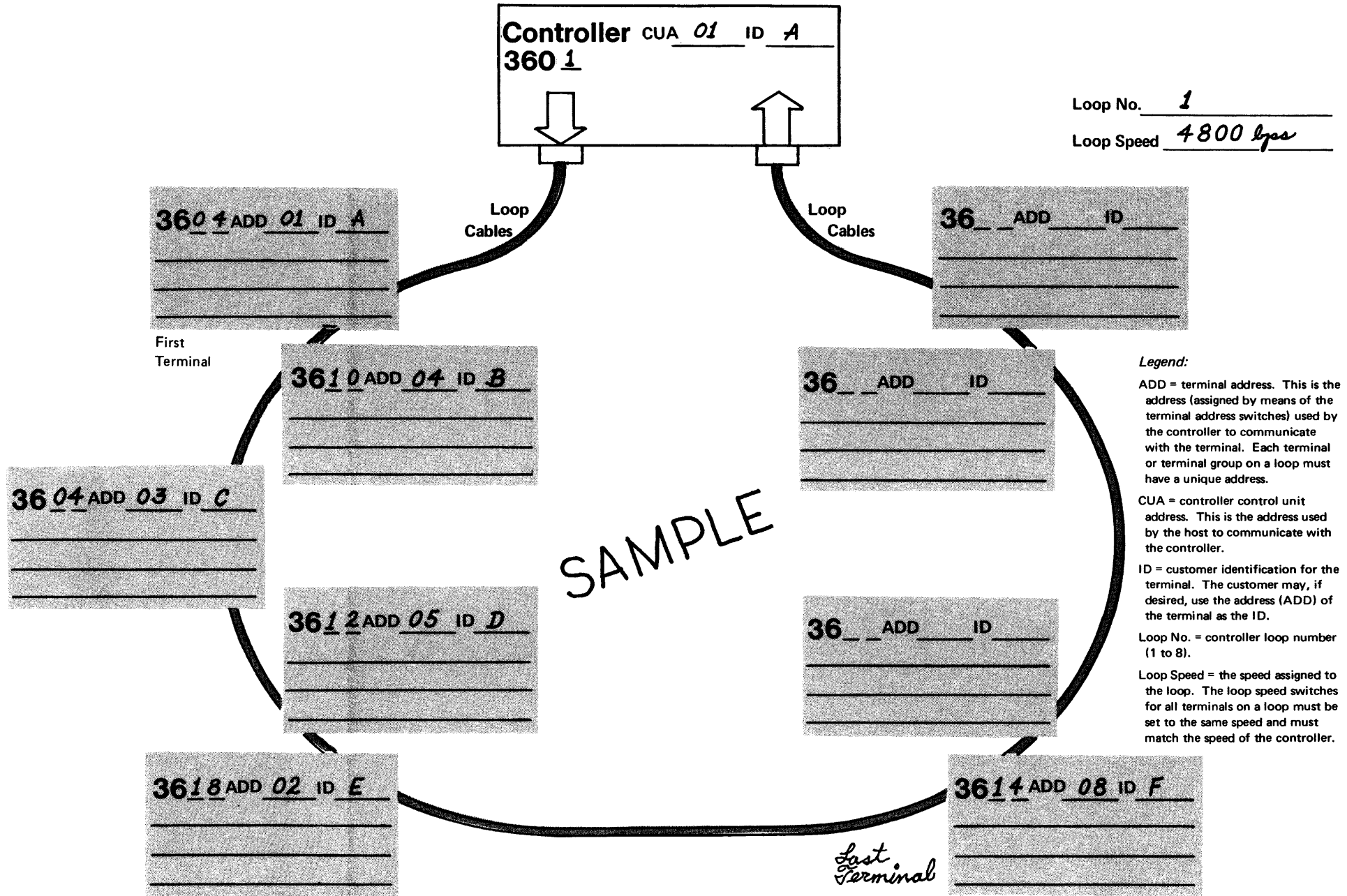




Local Loop Description Sheet



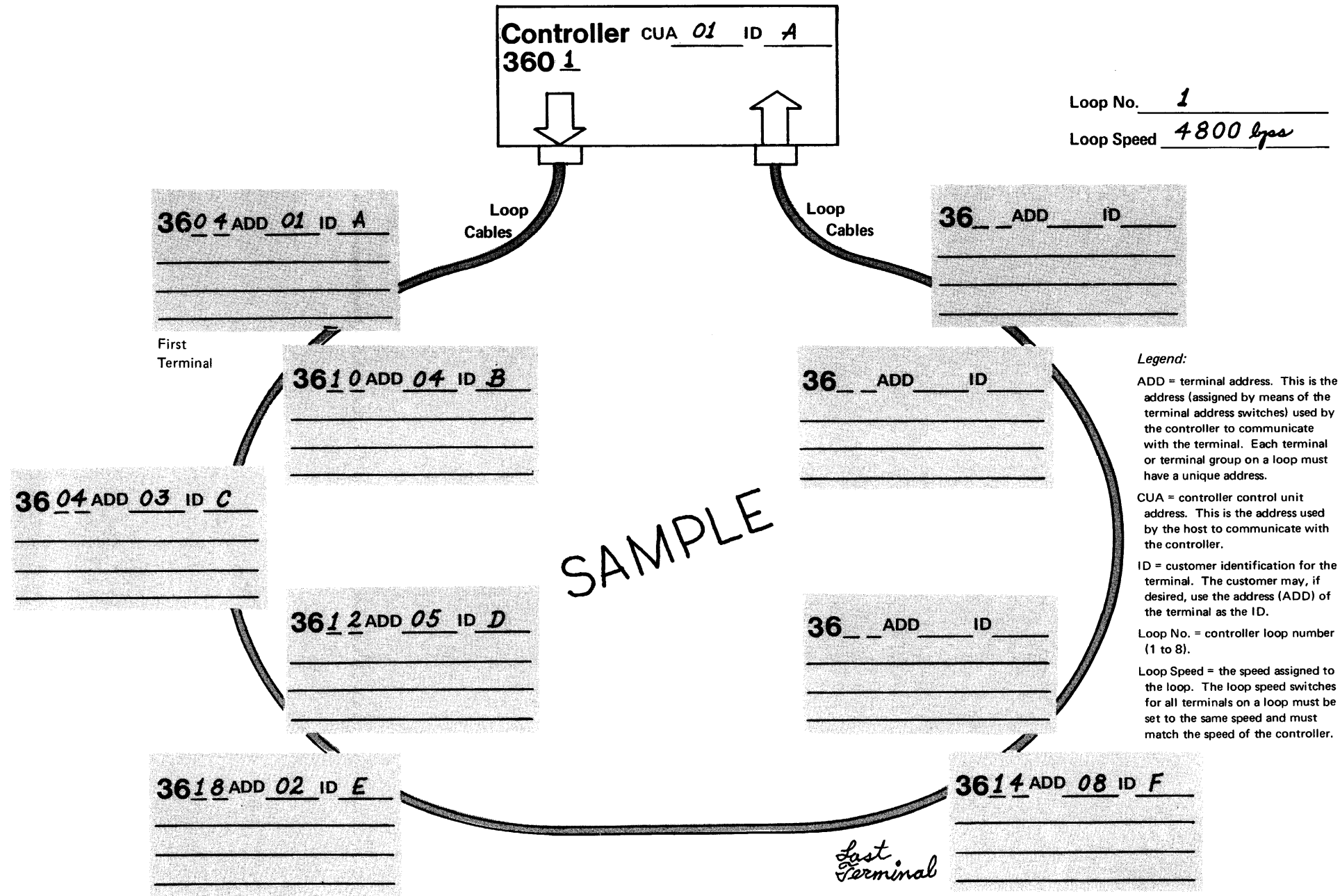
Local Loop Description Sheet



Local Loop Description Sheet

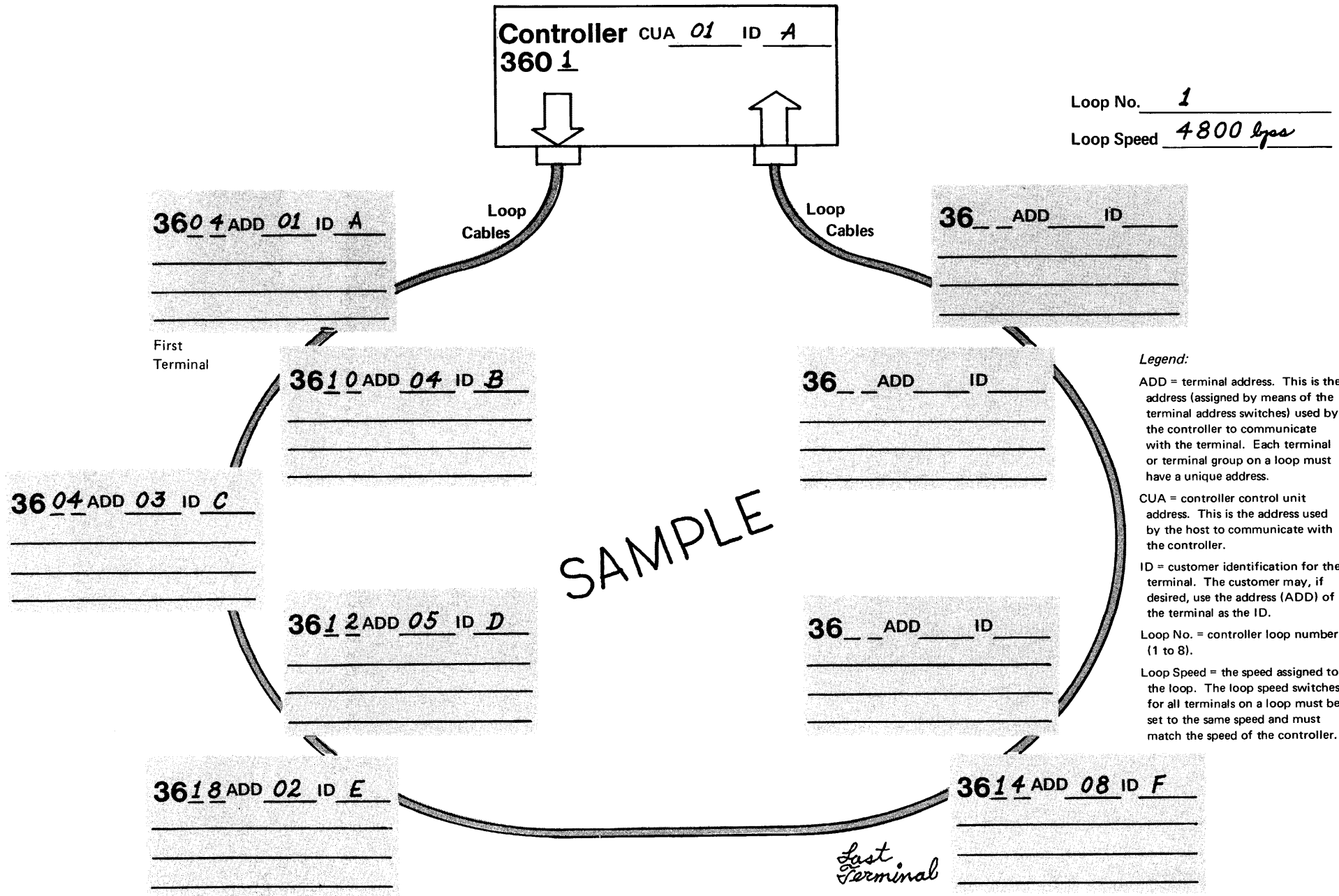






Local Loop Description Sheet



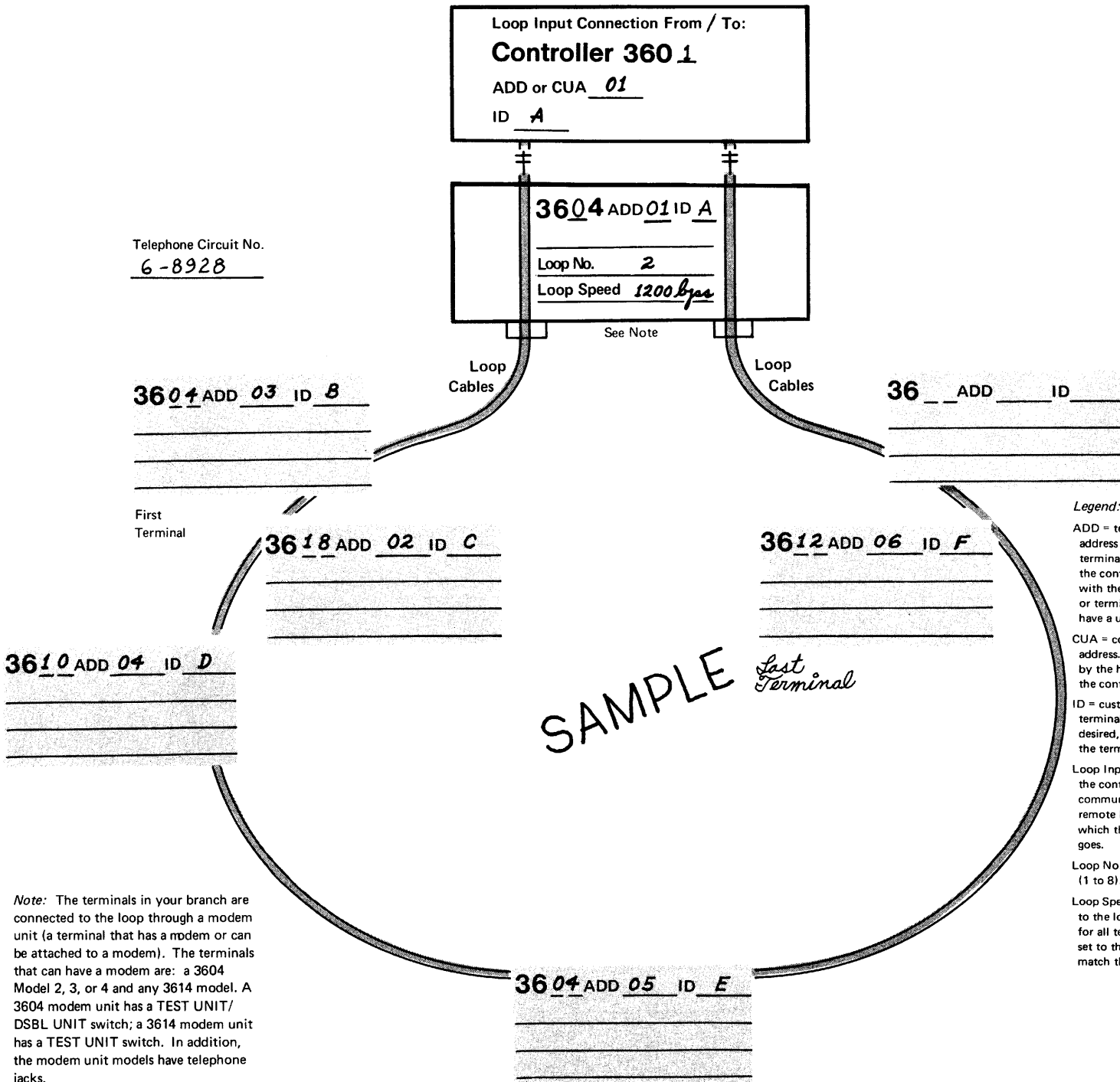


Local Loop Description Sheet



This page precedes the Single-Location Remote Loop Description Sheets.



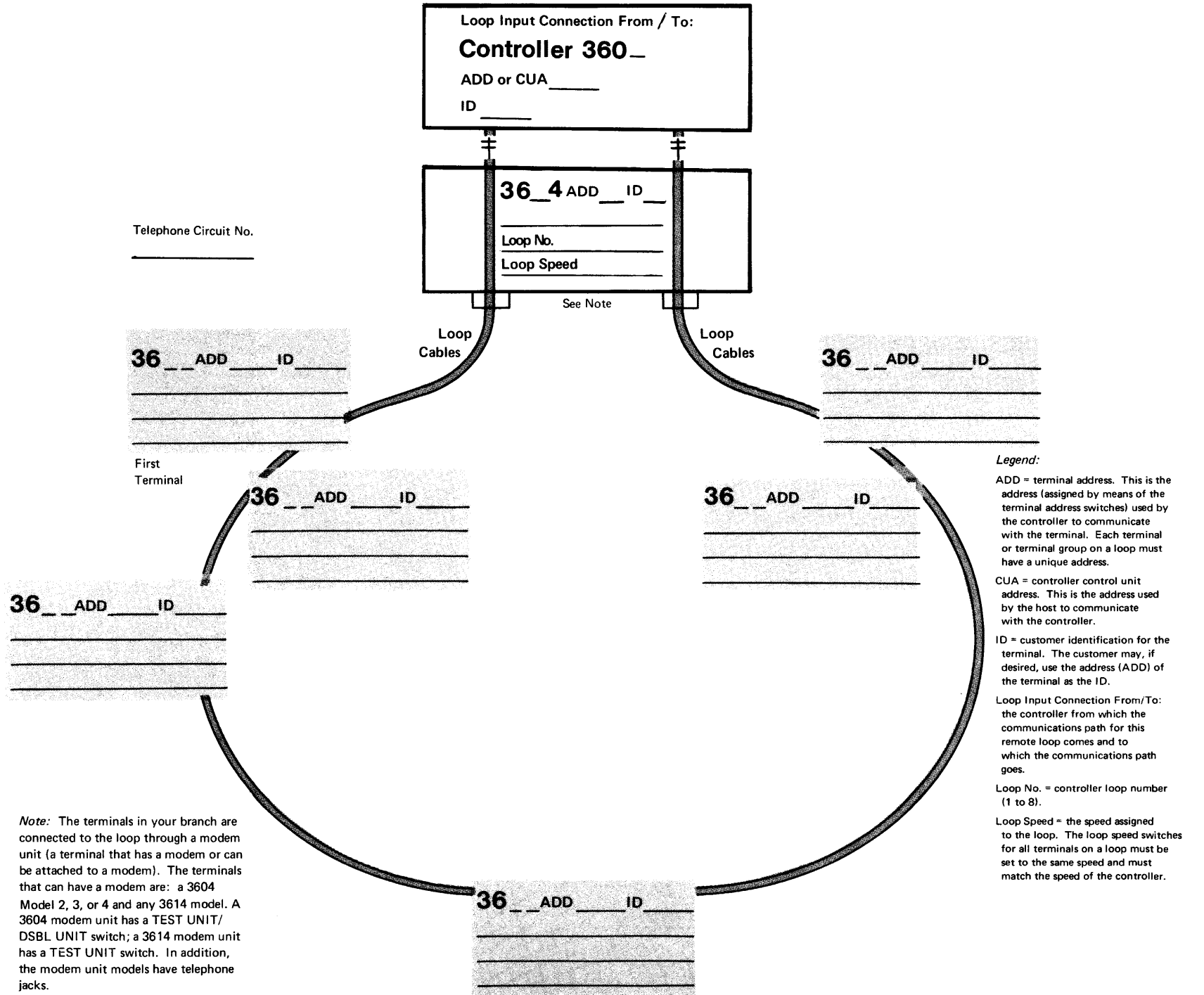


*Note:* The terminals in your branch are connected to the loop through a modem unit (a terminal that has a modem or can be attached to a modem). The terminals that can have a modem are: a 3604 Model 2, 3, or 4 and any 3614 model. A 3604 modem unit has a TEST UNIT/DSBL UNIT switch; a 3614 modem unit has a TEST UNIT switch. In addition, the modem unit models have telephone jacks.

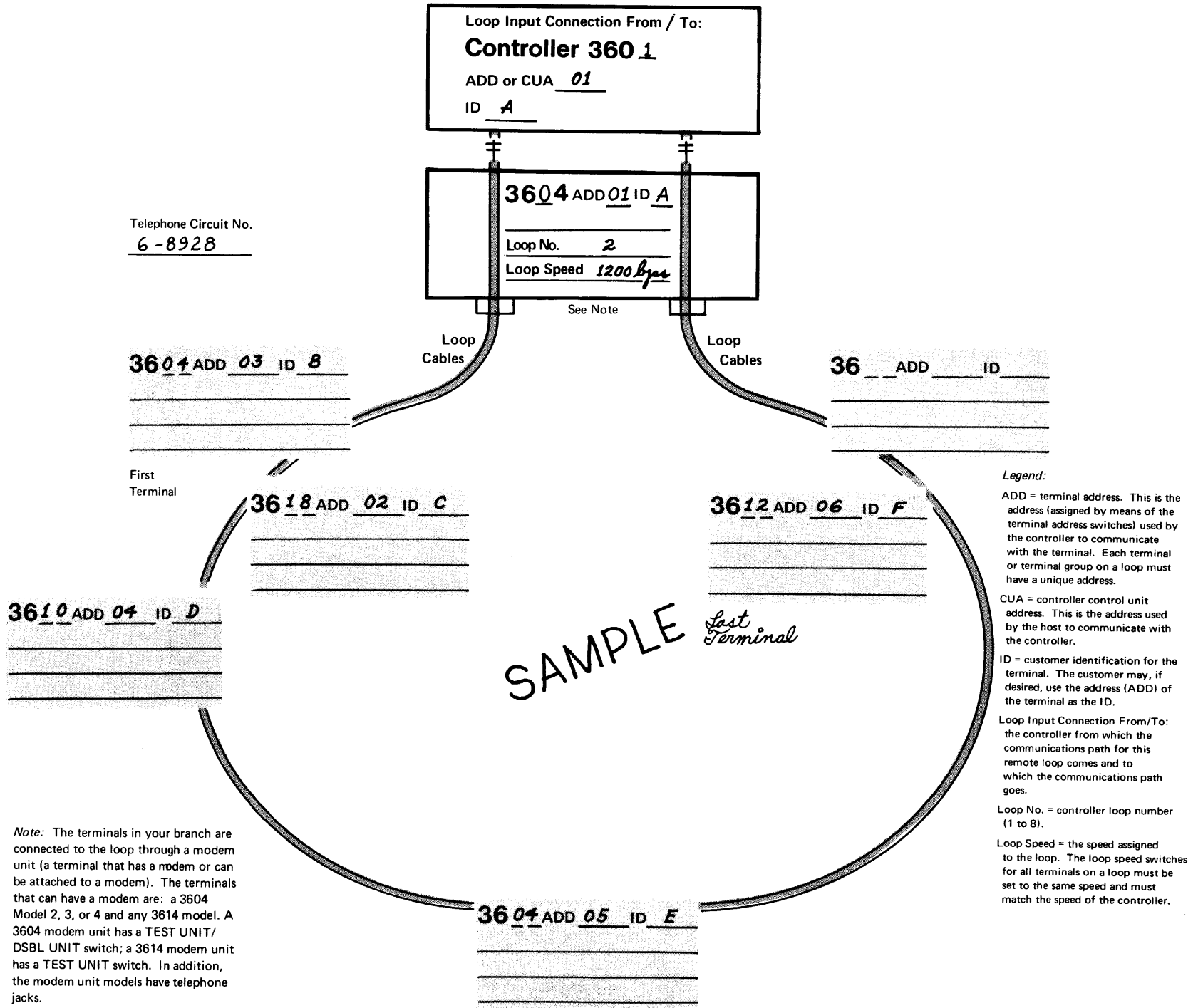
*Legend:*  
 ADD = terminal address. This is the address (assigned by means of the terminal address switches) used by the controller to communicate with the terminal. Each terminal or terminal group on a loop must have a unique address.  
 CUA = controller control unit address. This is the address used by the host to communicate with the controller.  
 ID = customer identification for the terminal. The customer may, if desired, use the address (ADD) of the terminal as the ID.  
 Loop Input Connection From/To: the controller from which the communications path for this remote loop comes and to which the communications path goes.  
 Loop No. = controller loop number (1 to 8).  
 Loop Speed = the speed assigned to the loop. The loop speed switches for all terminals on a loop must be set to the same speed and must match the speed of the controller.

Single-Location Remote Loop Description Sheet

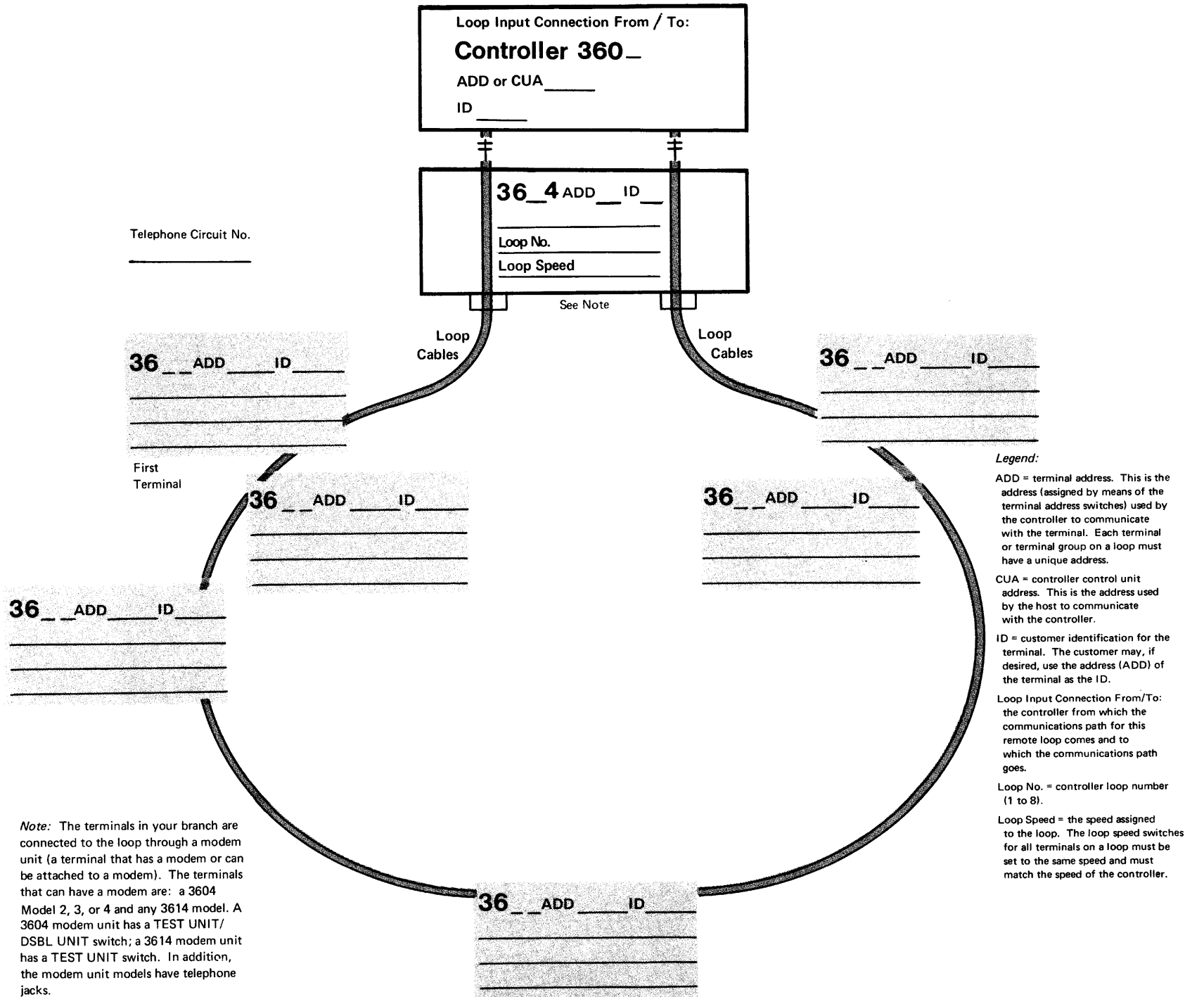




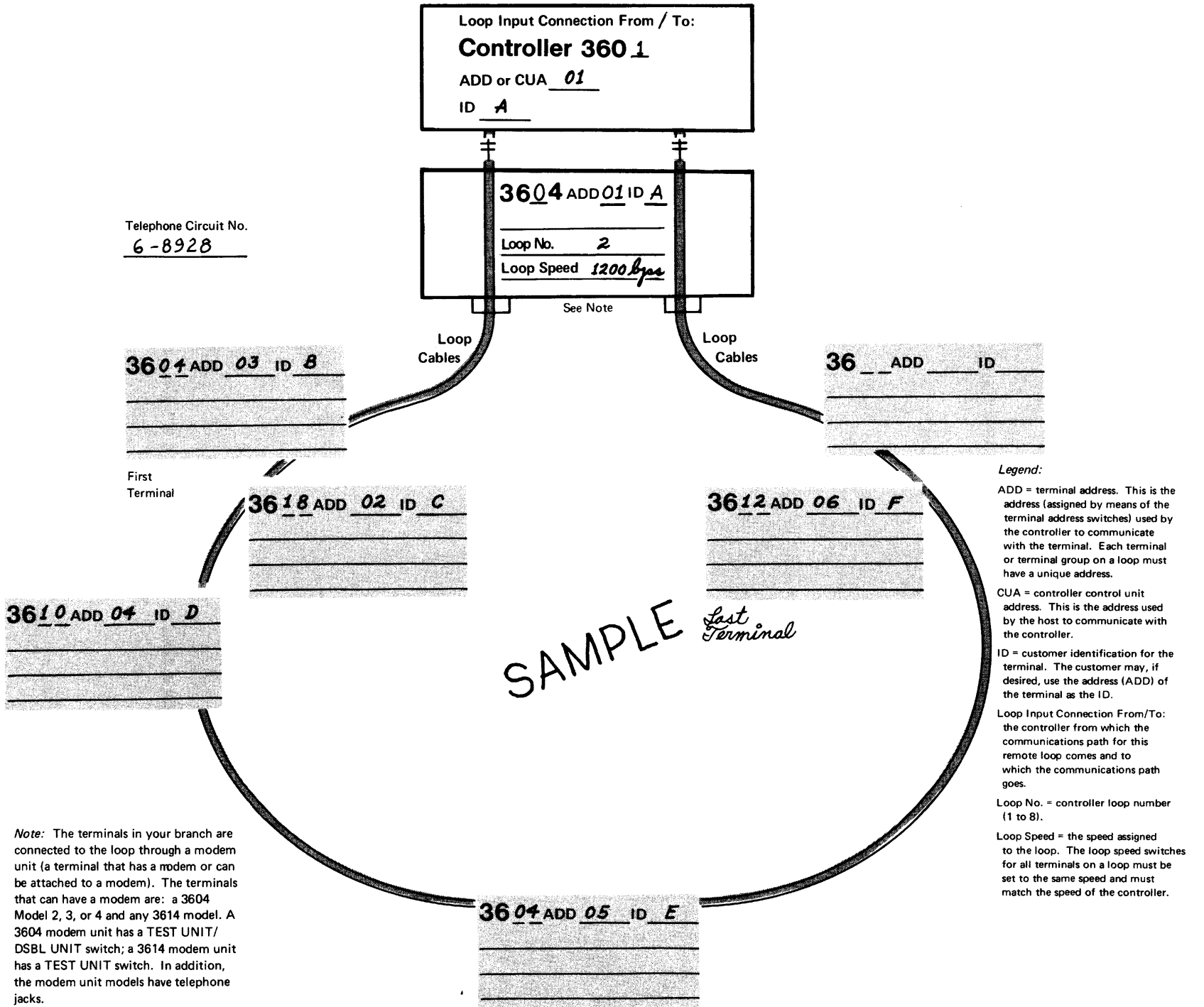
**Single-Location Remote Loop Description Sheet**



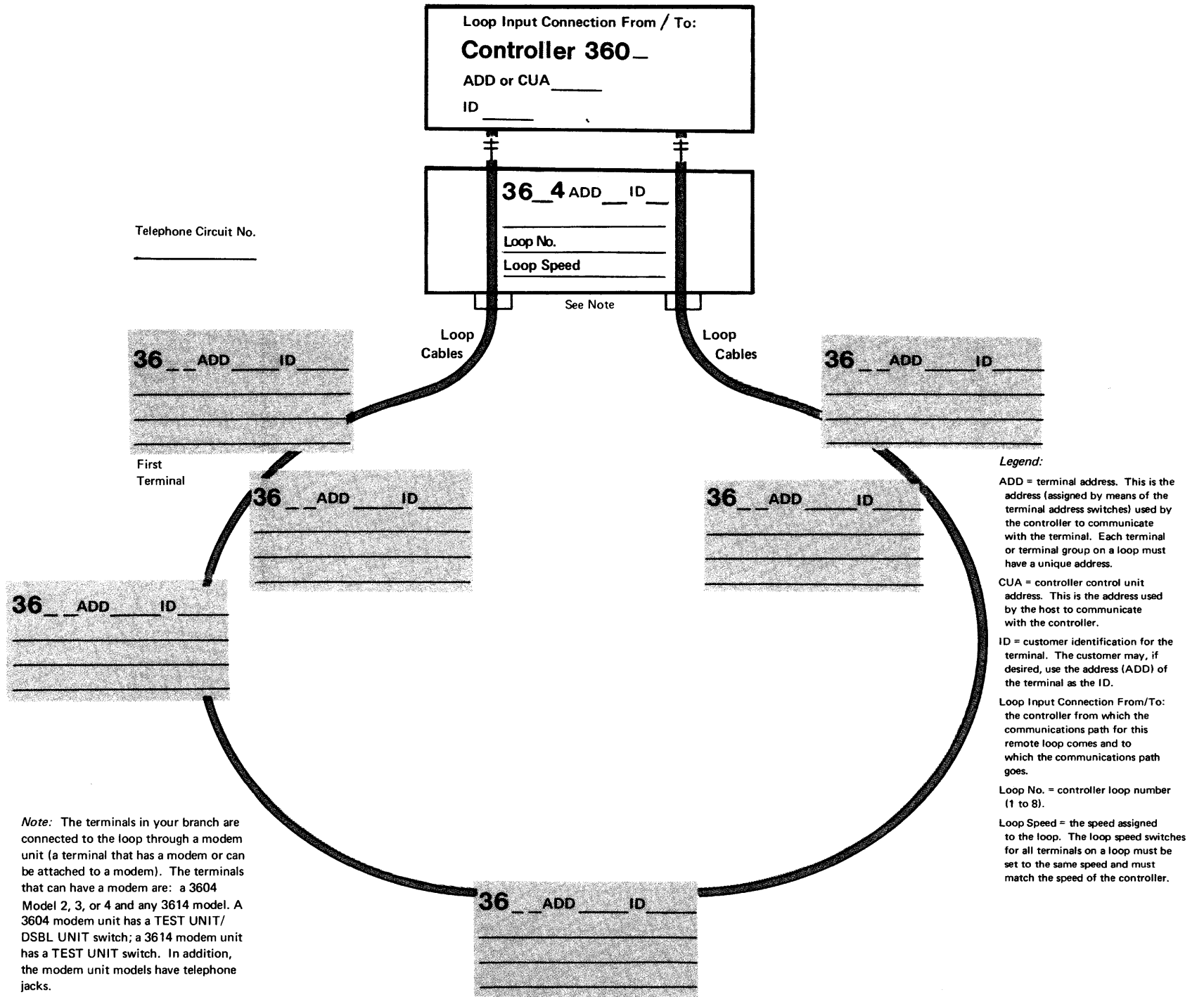
Single-Location Remote Loop Description Sheet



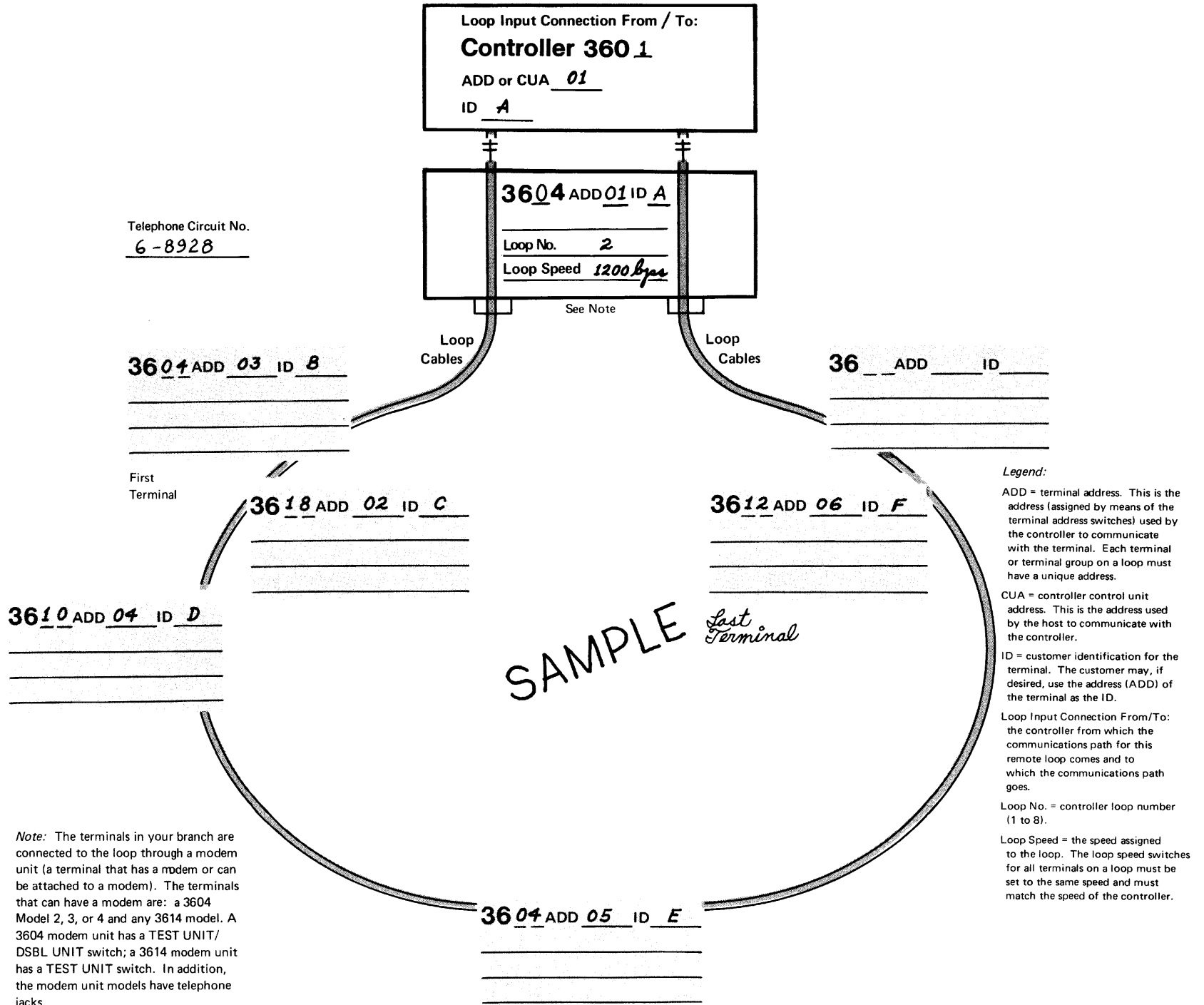
**Single-Location Remote Loop Description Sheet**



Single-Location Remote Loop Description Sheet



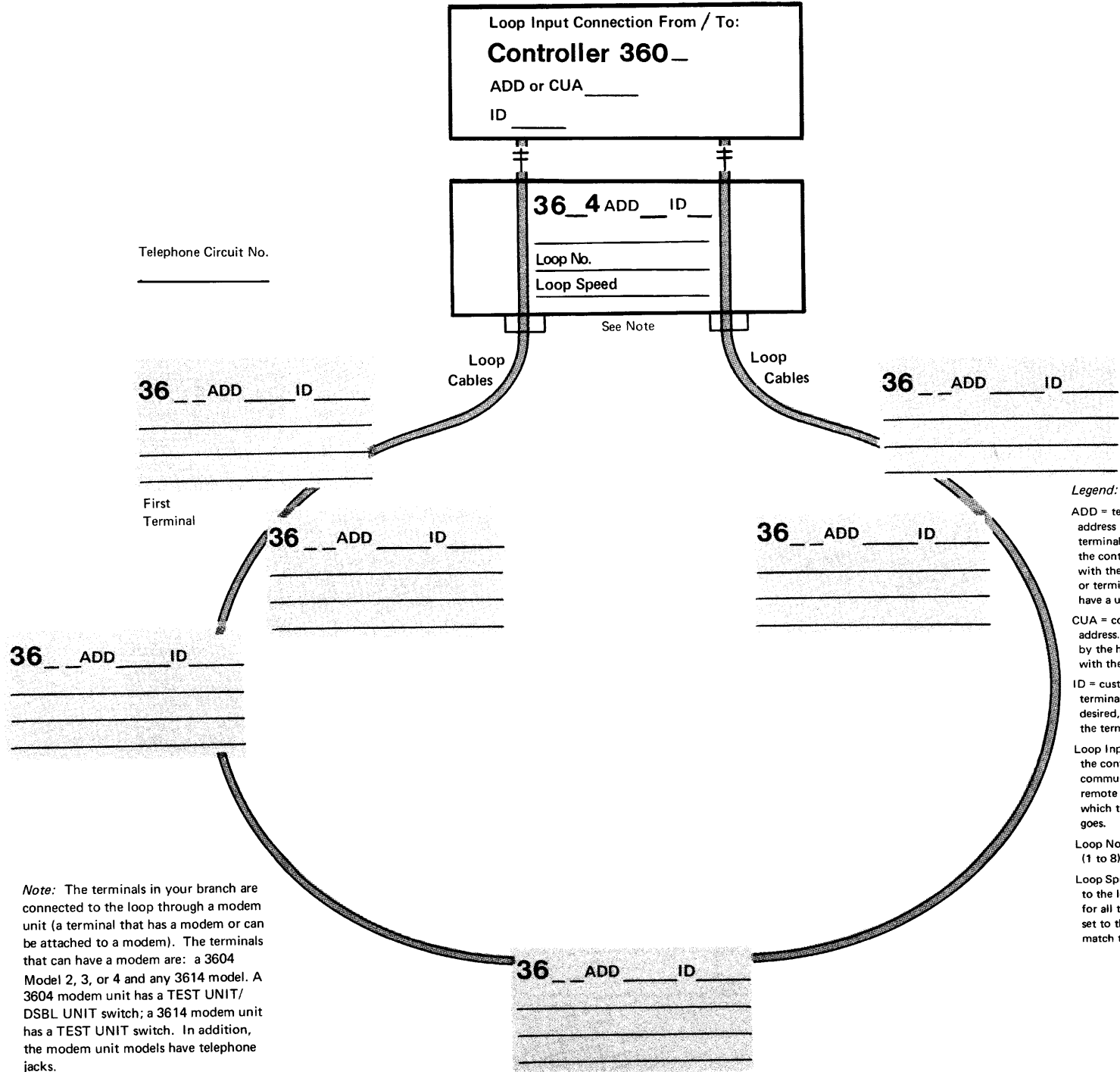
**Single-Location Remote Loop Description Sheet**



*Note:* The terminals in your branch are connected to the loop through a modem unit (a terminal that has a modem or can be attached to a modem). The terminals that can have a modem are: a 3604 Model 2, 3, or 4 and any 3614 model. A 3604 modem unit has a TEST UNIT/DSBL UNIT switch; a 3614 modem unit has a TEST UNIT switch. In addition, the modem unit models have telephone jacks.

**Legend:**  
 ADD = terminal address. This is the address (assigned by means of the terminal address switches) used by the controller to communicate with the terminal. Each terminal or terminal group on a loop must have a unique address.  
 CUA = controller control unit address. This is the address used by the host to communicate with the controller.  
 ID = customer identification for the terminal. The customer may, if desired, use the address (ADD) of the terminal as the ID.  
 Loop Input Connection From/To: the controller from which the communications path for this remote loop comes and to which the communications path goes.  
 Loop No. = controller loop number (1 to 8).  
 Loop Speed = the speed assigned to the loop. The loop speed switches for all terminals on a loop must be set to the same speed and must match the speed of the controller.

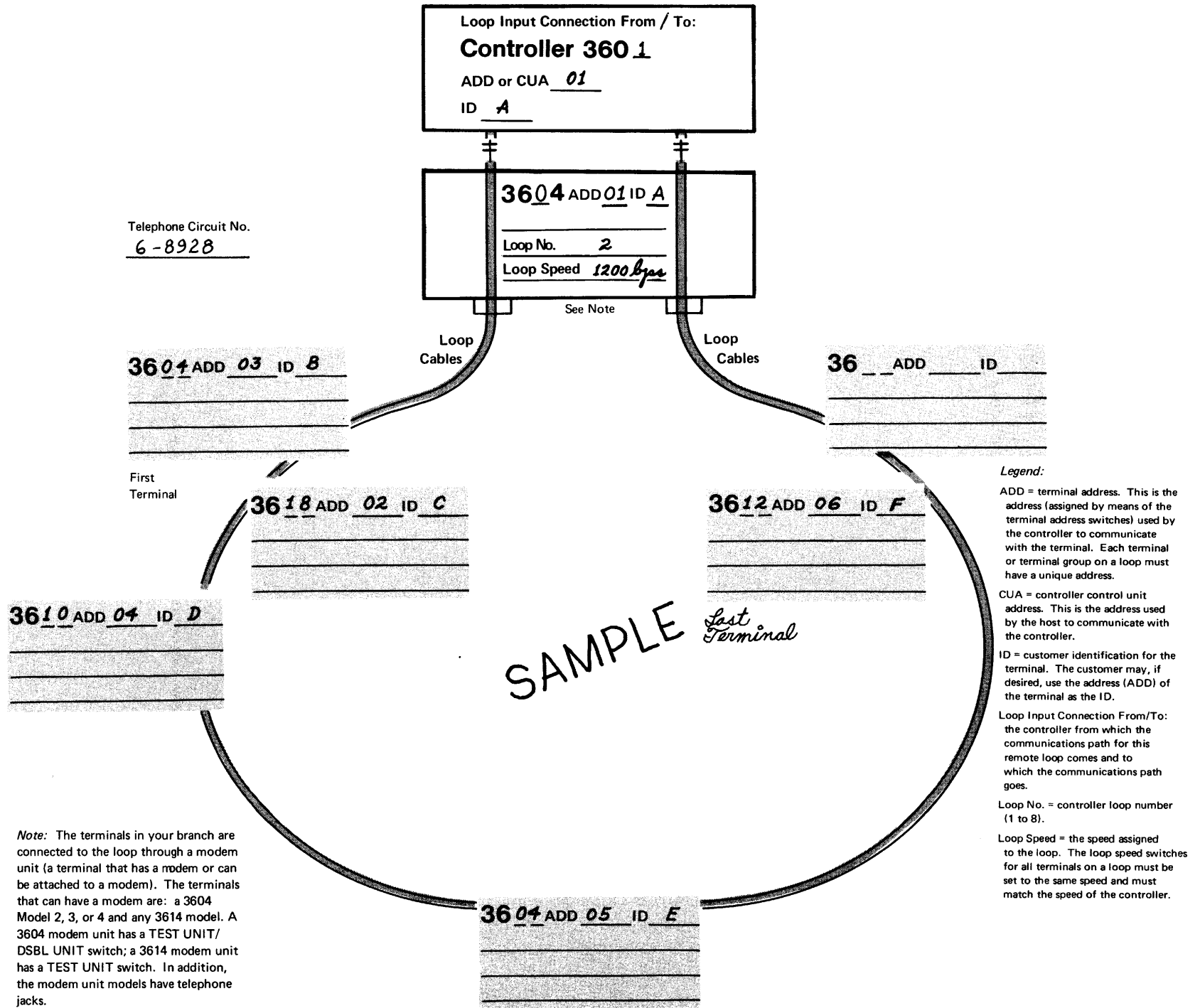
**Single-Location Remote Loop Description Sheet**



*Note:* The terminals in your branch are connected to the loop through a modem unit (a terminal that has a modem or can be attached to a modem). The terminals that can have a modem are: a 3604 Model 2, 3, or 4 and any 3614 model. A 3604 modem unit has a TEST UNIT/ DSBL UNIT switch; a 3614 modem unit has a TEST UNIT switch. In addition, the modem unit models have telephone jacks.

**Legend:**  
 ADD = terminal address. This is the address (assigned by means of the terminal address switches) used by the controller to communicate with the terminal. Each terminal or terminal group on a loop must have a unique address.  
 CUA = controller control unit address. This is the address used by the host to communicate with the controller.  
 ID = customer identification for the terminal. The customer may, if desired, use the address (ADD) of the terminal as the ID.  
 Loop Input Connection From/To: the controller from which the communications path for this remote loop comes and to which the communications path goes.  
 Loop No. = controller loop number (1 to 8).  
 Loop Speed = the speed assigned to the loop. The loop speed switches for all terminals on a loop must be set to the same speed and must match the speed of the controller.

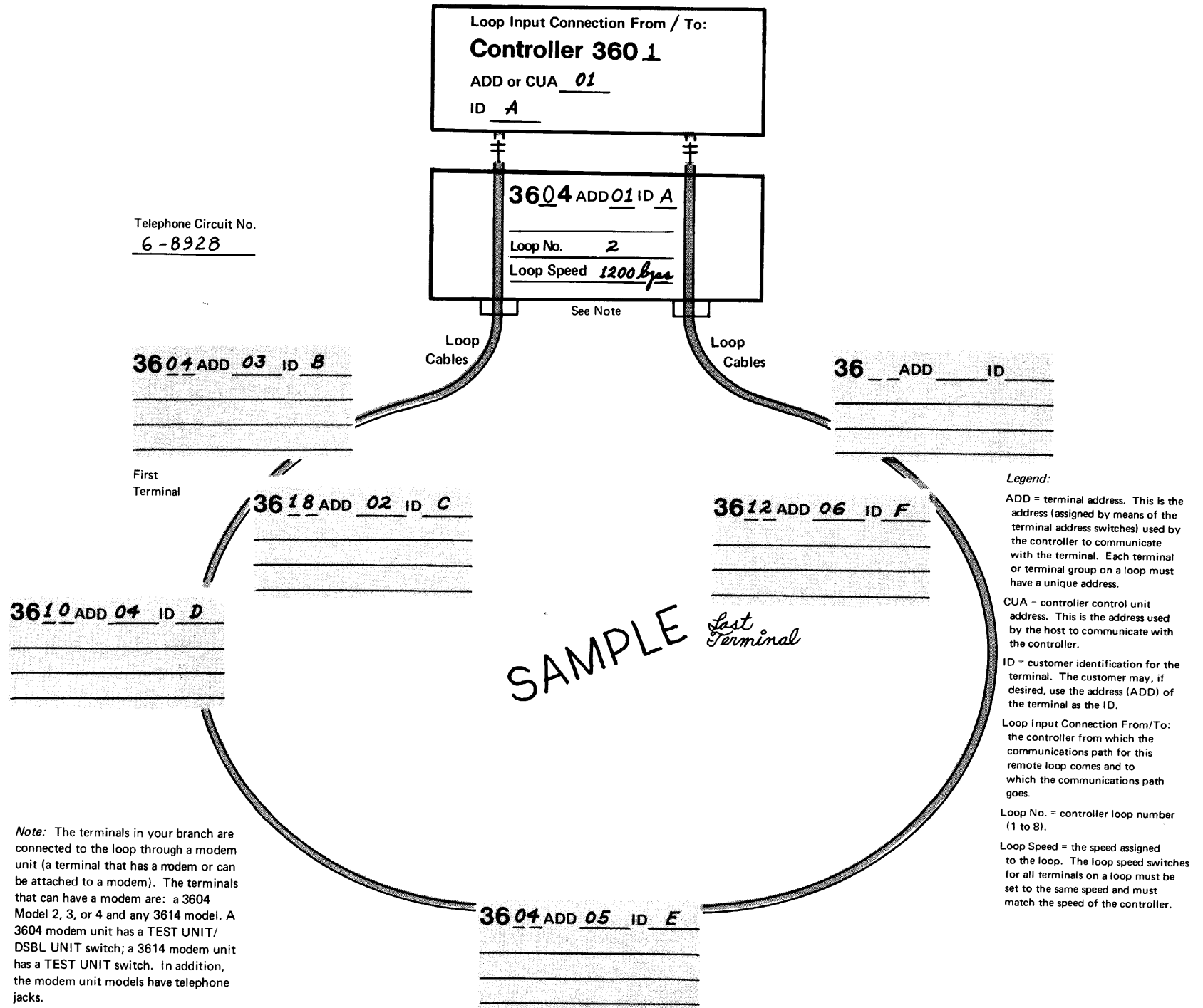
**Single-Location Remote Loop Description Sheet**



Single-Location Remote Loop Description Sheet





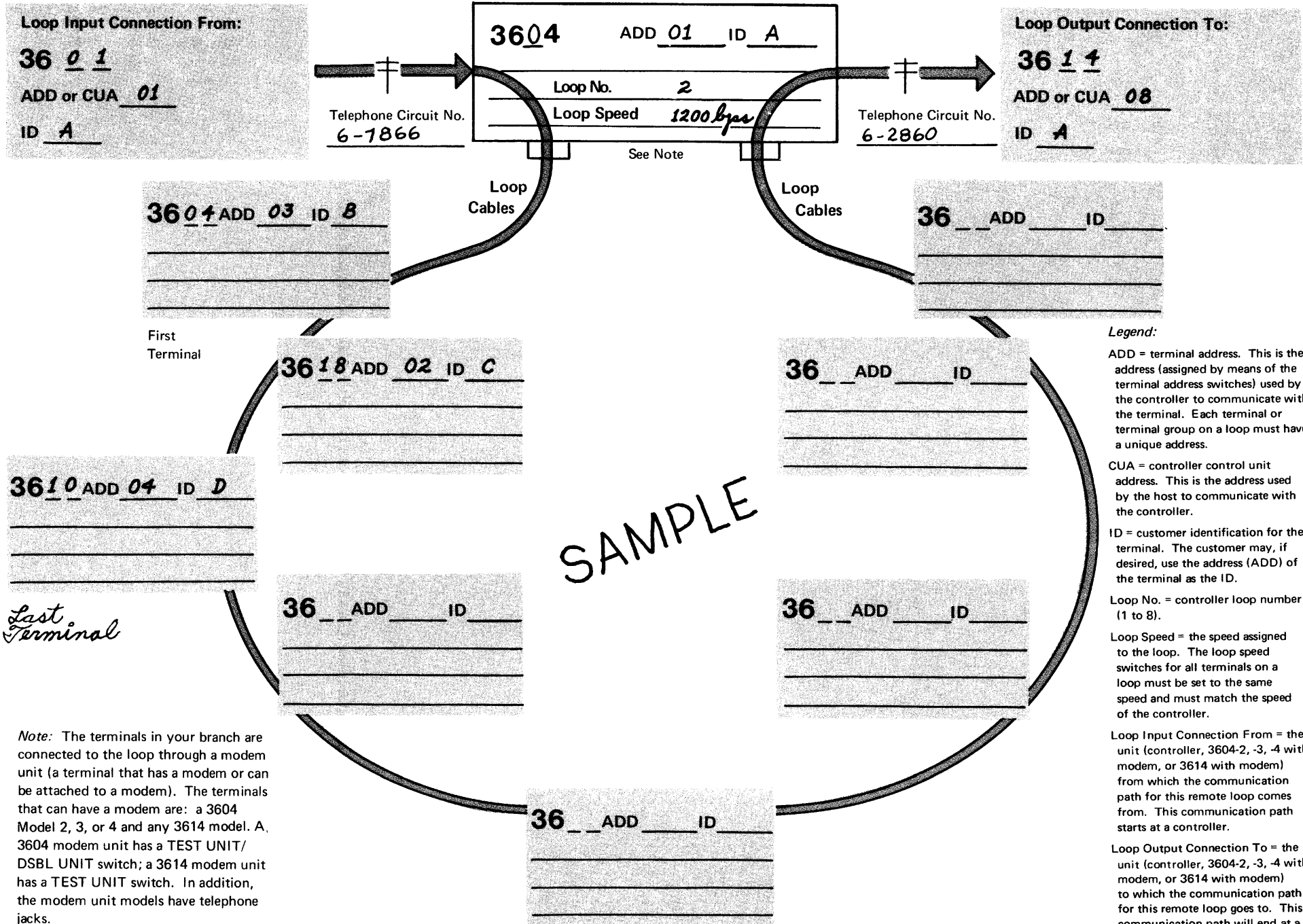


Single-Location Remote Loop Description Sheet



This page precedes the Multi-Location Remote Loop Description Sheets.





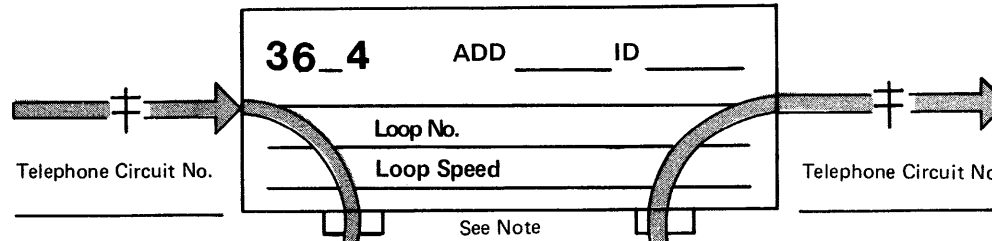
*Note:* The terminals in your branch are connected to the loop through a modem unit (a terminal that has a modem or can be attached to a modem). The terminals that can have a modem are: a 3604 Model 2, 3, or 4 and any 3614 model. A 3604 modem unit has a TEST UNIT/DSBL UNIT switch; a 3614 modem unit has a TEST UNIT switch. In addition, the modem unit models have telephone jacks.

**Legend:**  
 ADD = terminal address. This is the address (assigned by means of the terminal address switches) used by the controller to communicate with the terminal. Each terminal or terminal group on a loop must have a unique address.  
 CUA = controller control unit address. This is the address used by the host to communicate with the controller.  
 ID = customer identification for the terminal. The customer may, if desired, use the address (ADD) of the terminal as the ID.  
 Loop No. = controller loop number (1 to 8).  
 Loop Speed = the speed assigned to the loop. The loop speed switches for all terminals on a loop must be set to the same speed and must match the speed of the controller.  
 Loop Input Connection From = the unit (controller, 3604-2, -3, -4 with modem, or 3614 with modem) from which the communication path for this remote loop comes from. This communication path starts at a controller.  
 Loop Output Connection To = the unit (controller, 3604-2, -3, -4 with modem, or 3614 with modem) to which the communication path for this remote loop goes to. This communication path will end at a controller.

**Multi-Location Remote Loop Description Sheet**

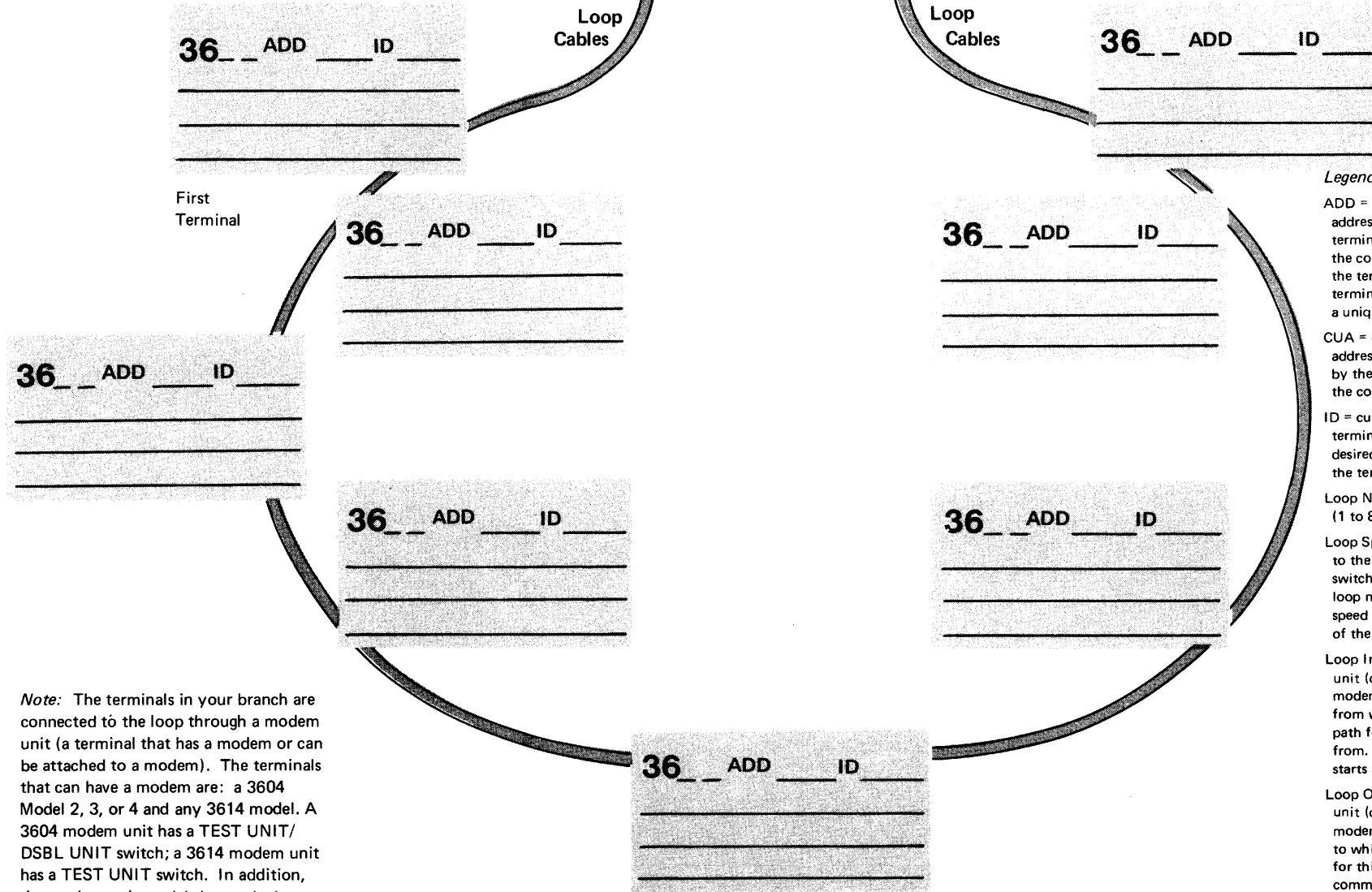
Loop Input Connection From:

36 \_ \_  
 ADD or CUA \_ \_  
 ID \_ \_



Loop Output Connection To:

36 \_ \_  
 ADD or CUA \_ \_  
 ID \_ \_



First Terminal

**Legend:**

ADD = terminal address. This is the address (assigned by means of the terminal address switches) used by the controller to communicate with the terminal. Each terminal or terminal group on a loop must have a unique address.

CUA = controller control unit address. This is the address used by the host to communicate with the controller.

ID = customer identification for the terminal. The customer may, if desired, use the address (ADD) of the terminal as the ID.

Loop No. = controller loop number (1 to 8).

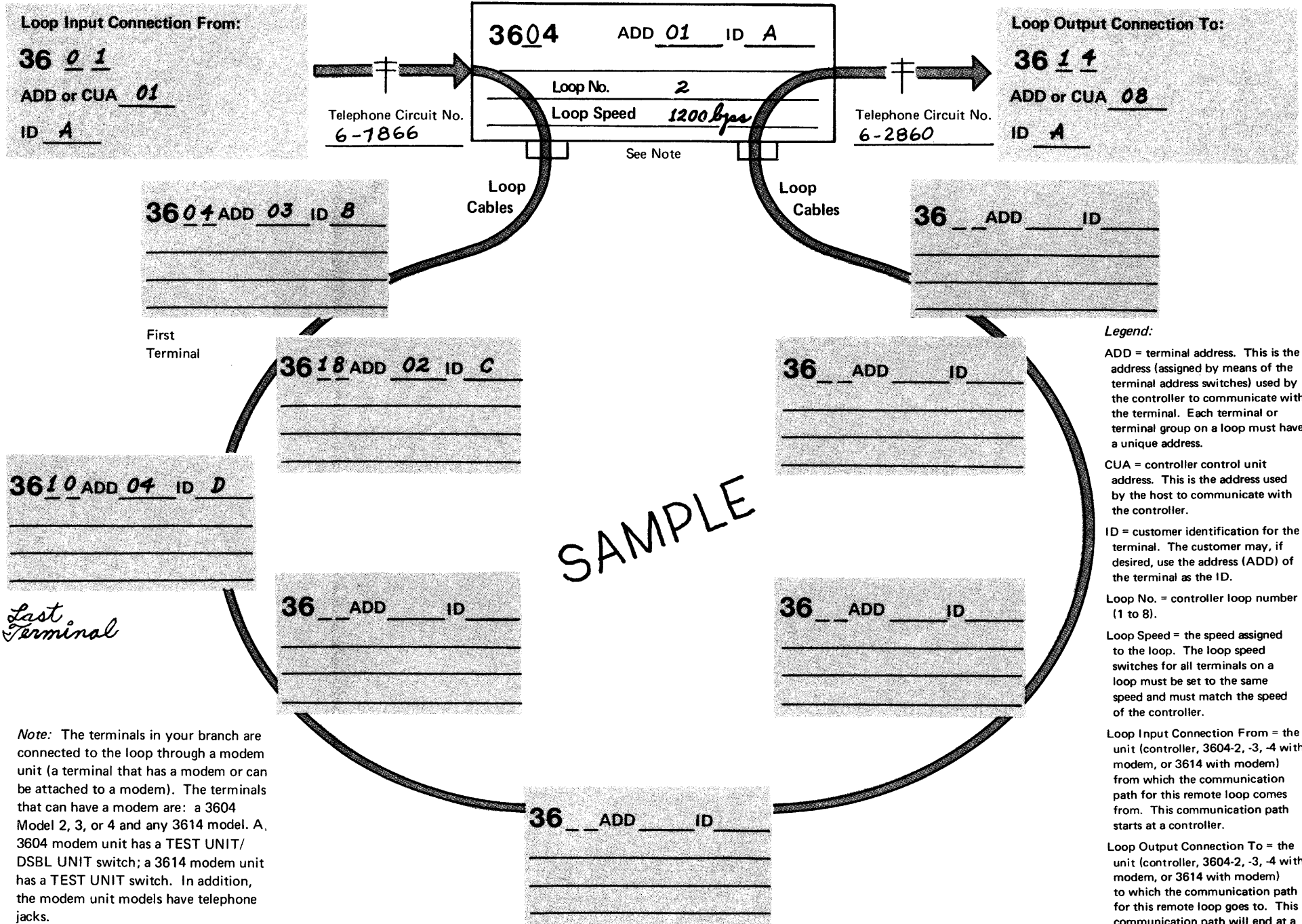
Loop Speed = the speed assigned to the loop. The loop speed switches for all terminals on a loop must be set to the same speed and must match the speed of the controller.

Loop Input Connection From = the unit (controller, 3604-2, -3, -4 with modem, or 3614 with modem) from which the communication path for this remote loop comes from. This communication path starts at a controller.

Loop Output Connection To = the unit (controller, 3604-2, -3, -4 with modem, or 3614 with modem) to which the communication path for this remote loop goes to. This communication path will end at a controller.

*Note:* The terminals in your branch are connected to the loop through a modem unit (a terminal that has a modem or can be attached to a modem). The terminals that can have a modem are: a 3604 Model 2, 3, or 4 and any 3614 model. A 3604 modem unit has a TEST UNIT/DSBL UNIT switch; a 3614 modem unit has a TEST UNIT switch. In addition, the modem unit models have telephone jacks.

**Multi-Location Remote Loop Description Sheet**



*Note:* The terminals in your branch are connected to the loop through a modem unit (a terminal that has a modem or can be attached to a modem). The terminals that can have a modem are: a 3604 Model 2, 3, or 4 and any 3614 model. A, 3604 modem unit has a TEST UNIT/DSBL UNIT switch; a 3614 modem unit has a TEST UNIT switch. In addition, the modem unit models have telephone jacks.

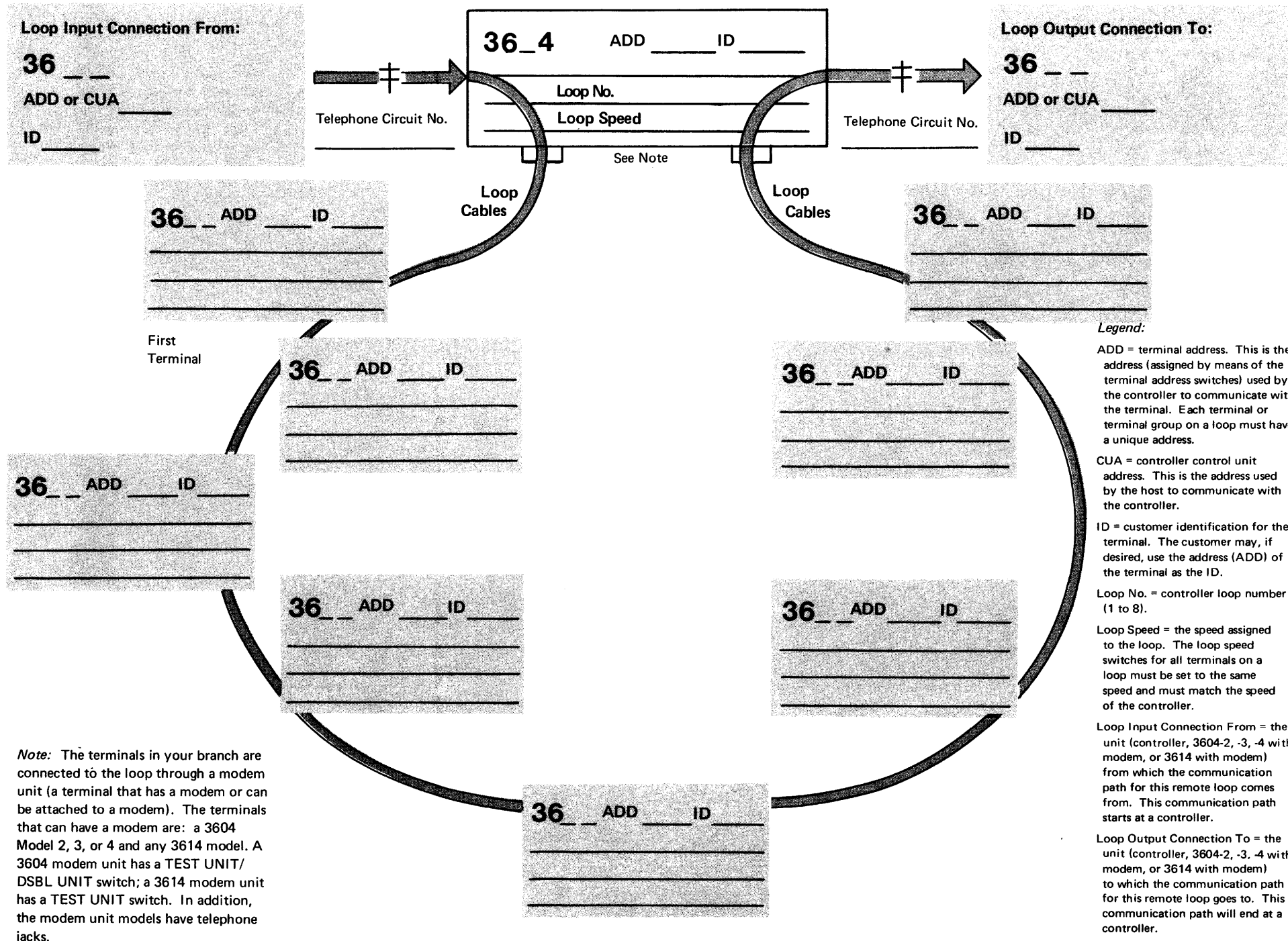
**Legend:**  
 ADD = terminal address. This is the address (assigned by means of the terminal address switches) used by the controller to communicate with the terminal. Each terminal or terminal group on a loop must have a unique address.  
 CUA = controller control unit address. This is the address used by the host to communicate with the controller.  
 ID = customer identification for the terminal. The customer may, if desired, use the address (ADD) of the terminal as the ID.  
 Loop No. = controller loop number (1 to 8).  
 Loop Speed = the speed assigned to the loop. The loop speed switches for all terminals on a loop must be set to the same speed and must match the speed of the controller.  
 Loop Input Connection From = the unit (controller, 3604-2, -3, -4 with modem, or 3614 with modem) from which the communication path for this remote loop comes from. This communication path starts at a controller.  
 Loop Output Connection To = the unit (controller, 3604-2, -3, -4 with modem, or 3614 with modem) to which the communication path for this remote loop goes to. This communication path will end at a controller.

Multi-Location Remote Loop Description Sheet

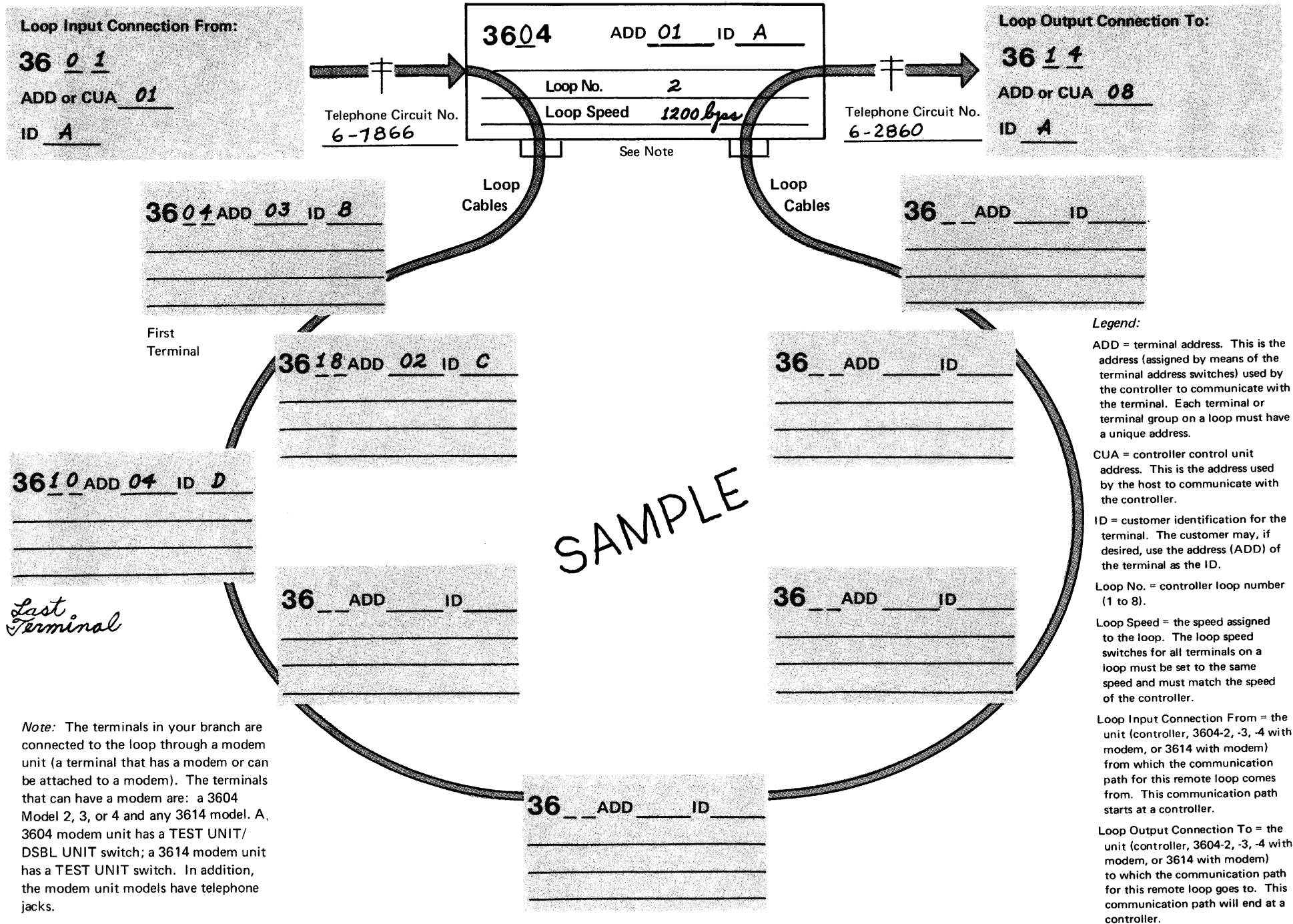








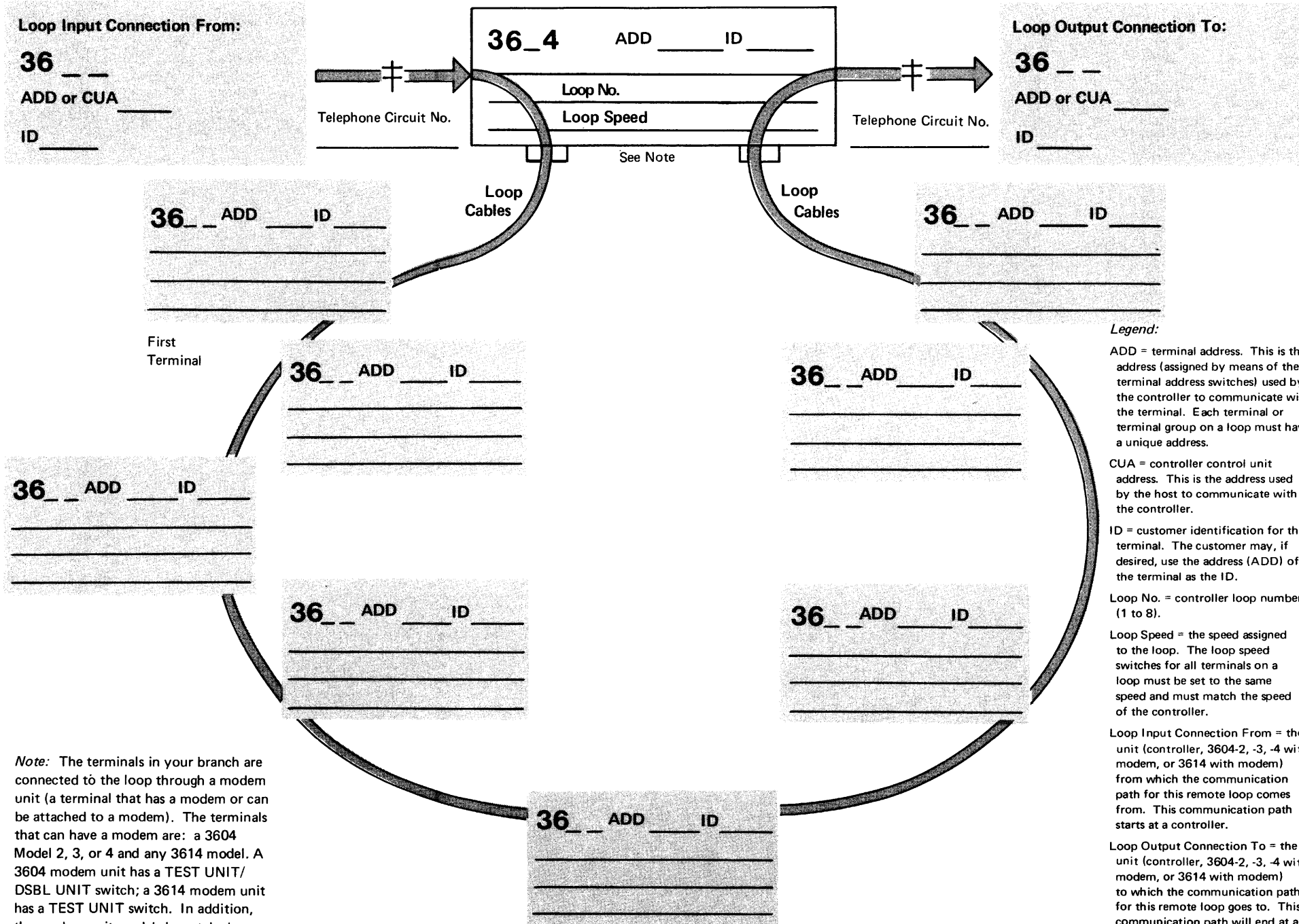
**Multi-Location Remote Loop Description Sheet**



*Note:* The terminals in your branch are connected to the loop through a modem unit (a terminal that has a modem or can be attached to a modem). The terminals that can have a modem are: a 3604 Model 2, 3, or 4 and any 3614 model. A, 3604 modem unit has a TEST UNIT/DSBL UNIT switch; a 3614 modem unit has a TEST UNIT switch. In addition, the modem unit models have telephone jacks.

**Legend:**  
 ADD = terminal address. This is the address (assigned by means of the terminal address switches) used by the controller to communicate with the terminal. Each terminal or terminal group on a loop must have a unique address.  
 CUA = controller control unit address. This is the address used by the host to communicate with the controller.  
 ID = customer identification for the terminal. The customer may, if desired, use the address (ADD) of the terminal as the ID.  
 Loop No. = controller loop number (1 to 8).  
 Loop Speed = the speed assigned to the loop. The loop speed switches for all terminals on a loop must be set to the same speed and must match the speed of the controller.  
 Loop Input Connection From = the unit (controller, 3604-2, -3, -4 with modem, or 3614 with modem) from which the communication path for this remote loop comes from. This communication path starts at a controller.  
 Loop Output Connection To = the unit (controller, 3604-2, -3, -4 with modem, or 3614 with modem) to which the communication path for this remote loop goes to. This communication path will end at a controller.

**Multi-Location Remote Loop Description Sheet**

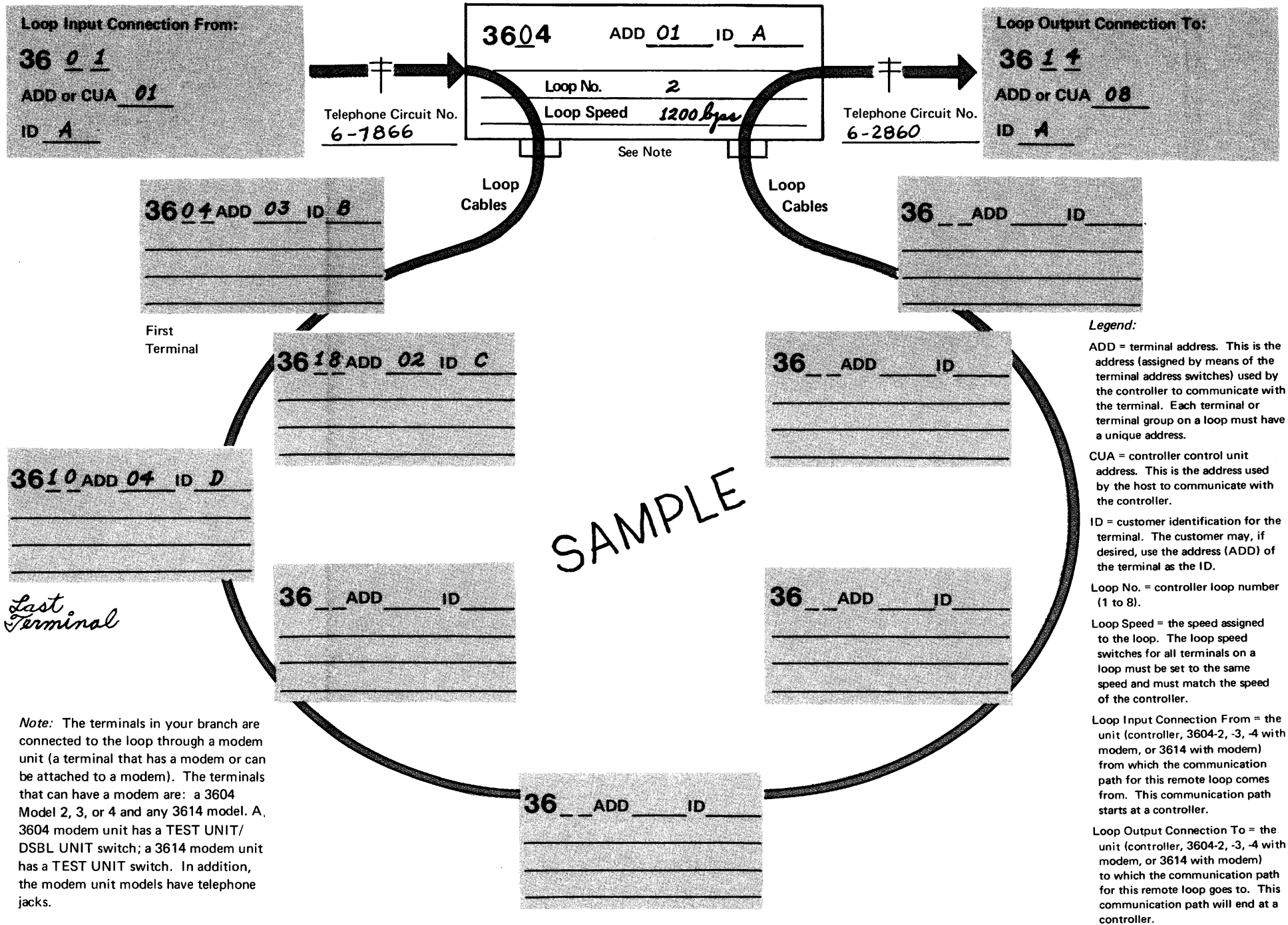


*Note:* The terminals in your branch are connected to the loop through a modem unit (a terminal that has a modem or can be attached to a modem). The terminals that can have a modem are: a 3604 Model 2, 3, or 4 and any 3614 model. A 3604 modem unit has a TEST UNIT/DSBL UNIT switch; a 3614 modem unit has a TEST UNIT switch. In addition, the modem unit models have telephone jacks.

**Legend:**  
 ADD = terminal address. This is the address (assigned by means of the terminal address switches) used by the controller to communicate with the terminal. Each terminal or terminal group on a loop must have a unique address.  
 CUA = controller control unit address. This is the address used by the host to communicate with the controller.  
 ID = customer identification for the terminal. The customer may, if desired, use the address (ADD) of the terminal as the ID.  
 Loop No. = controller loop number (1 to 8).  
 Loop Speed = the speed assigned to the loop. The loop speed switches for all terminals on a loop must be set to the same speed and must match the speed of the controller.  
 Loop Input Connection From = the unit (controller, 3604-2, -3, -4 with modem, or 3614 with modem) from which the communication path for this remote loop comes from. This communication path starts at a controller.  
 Loop Output Connection To = the unit (controller, 3604-2, -3, -4 with modem, or 3614 with modem) to which the communication path for this remote loop goes to. This communication path will end at a controller.

**Multi-Location Remote Loop Description Sheet**





*Note:* The terminals in your branch are connected to the loop through a modem unit (a terminal that has a modem or can be attached to a modem). The terminals that can have a modem are: a 3604 Model 2, 3, or 4 and any 3614 model. A 3604 modem unit has a TEST UNIT/DSBL UNIT switch; a 3614 modem unit has a TEST UNIT switch. In addition, the modem unit models have telephone jacks.

**Legend:**

ADD = terminal address. This is the address (assigned by means of the terminal address switches) used by the controller to communicate with the terminal. Each terminal or terminal group on a loop must have a unique address.

CUA = controller control unit address. This is the address used by the host to communicate with the controller.

ID = customer identification for the terminal. The customer may, if desired, use the address (ADD) of the terminal as the ID.

Loop No. = controller loop number (1 to 8).

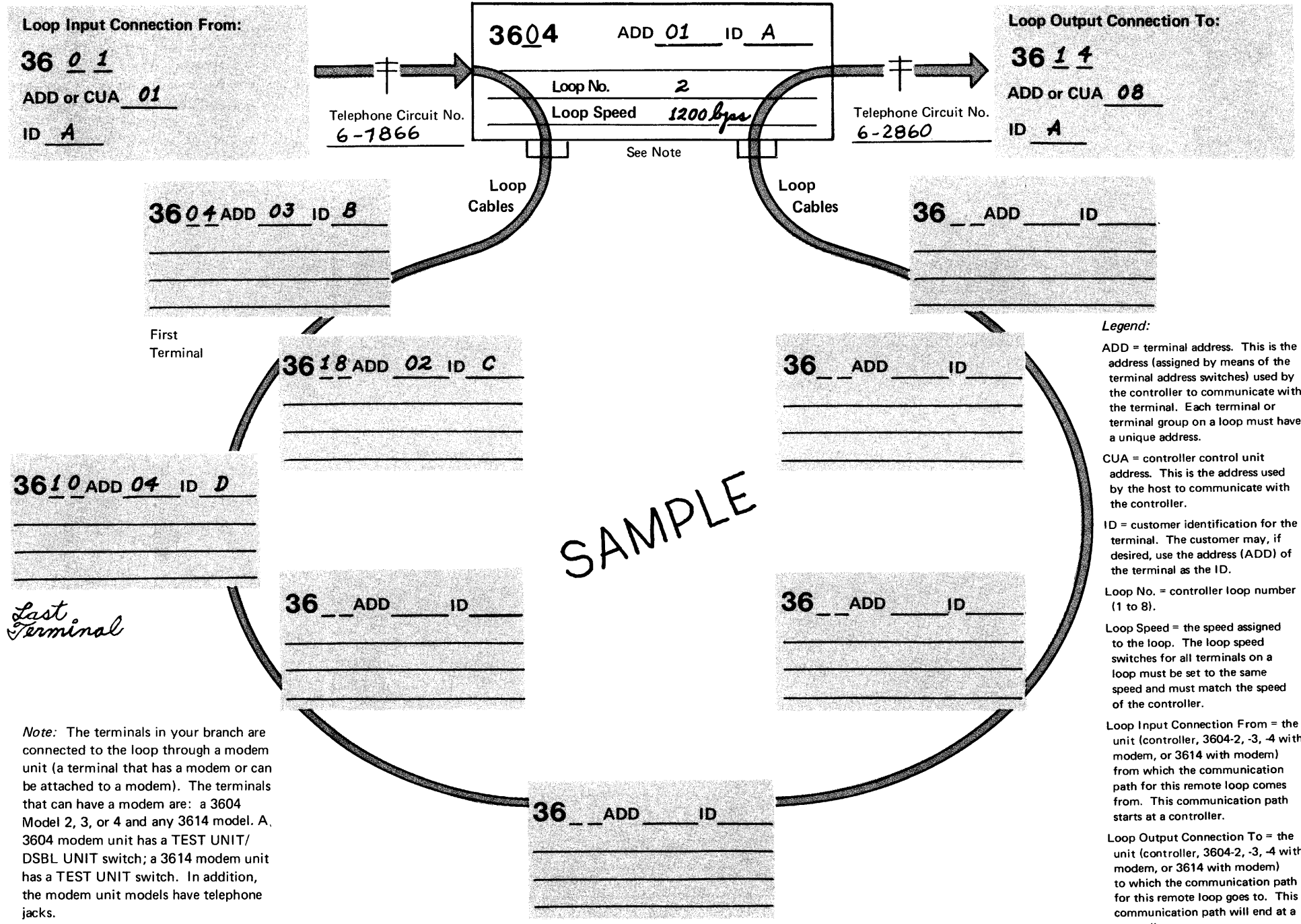
Loop Speed = the speed assigned to the loop. The loop speed switches for all terminals on a loop must be set to the same speed and must match the speed of the controller.

Loop Input Connection From = the unit (controller, 3604-2, -3, -4 with modem, or 3614 with modem) from which the communication path for this remote loop comes from. This communication path starts at a controller.

Loop Output Connection To = the unit (controller, 3604-2, -3, -4 with modem, or 3614 with modem) to which the communication path for this remote loop goes to. This communication path will end at a controller.

**Multi-Location Remote Loop Description Sheet**



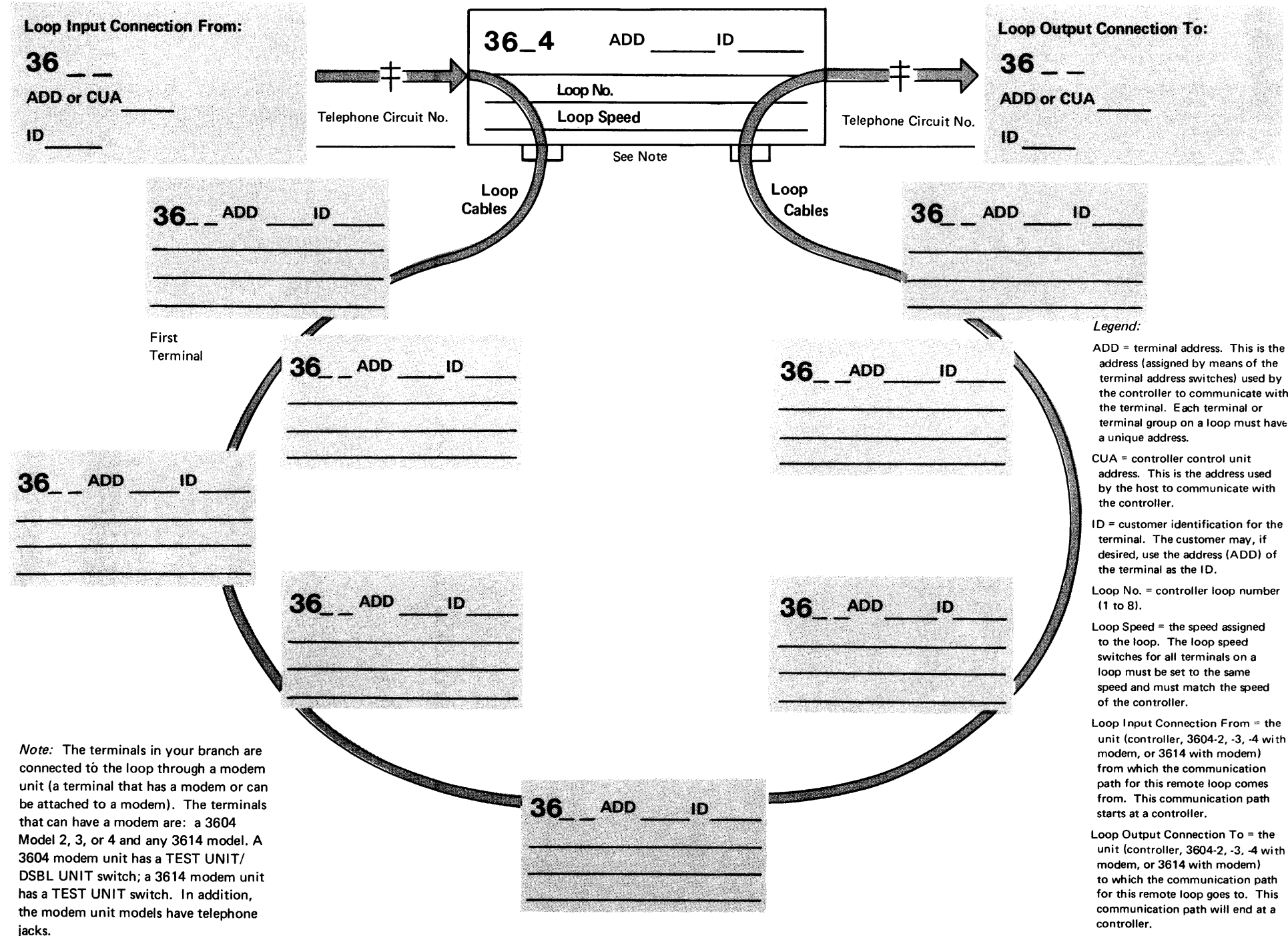


*Note:* The terminals in your branch are connected to the loop through a modem unit (a terminal that has a modem or can be attached to a modem). The terminals that can have a modem are: a 3604 Model 2, 3, or 4 and any 3614 model. A, 3604 modem unit has a TEST UNIT/DSBL UNIT switch; a 3614 modem unit has a TEST UNIT switch. In addition, the modem unit models have telephone jacks.

**Legend:**  
 ADD = terminal address. This is the address (assigned by means of the terminal address switches) used by the controller to communicate with the terminal. Each terminal or terminal group on a loop must have a unique address.  
 CUA = controller control unit address. This is the address used by the host to communicate with the controller.  
 ID = customer identification for the terminal. The customer may, if desired, use the address (ADD) of the terminal as the ID.  
 Loop No. = controller loop number (1 to 8).  
 Loop Speed = the speed assigned to the loop. The loop speed switches for all terminals on a loop must be set to the same speed and must match the speed of the controller.  
 Loop Input Connection From = the unit (controller, 3604-2, -3, -4 with modem, or 3614 with modem) from which the communication path for this remote loop comes from. This communication path starts at a controller.  
 Loop Output Connection To = the unit (controller, 3604-2, -3, -4 with modem, or 3614 with modem) to which the communication path for this remote loop goes to. This communication path will end at a controller.

**Multi-Location Remote Loop Description Sheet**



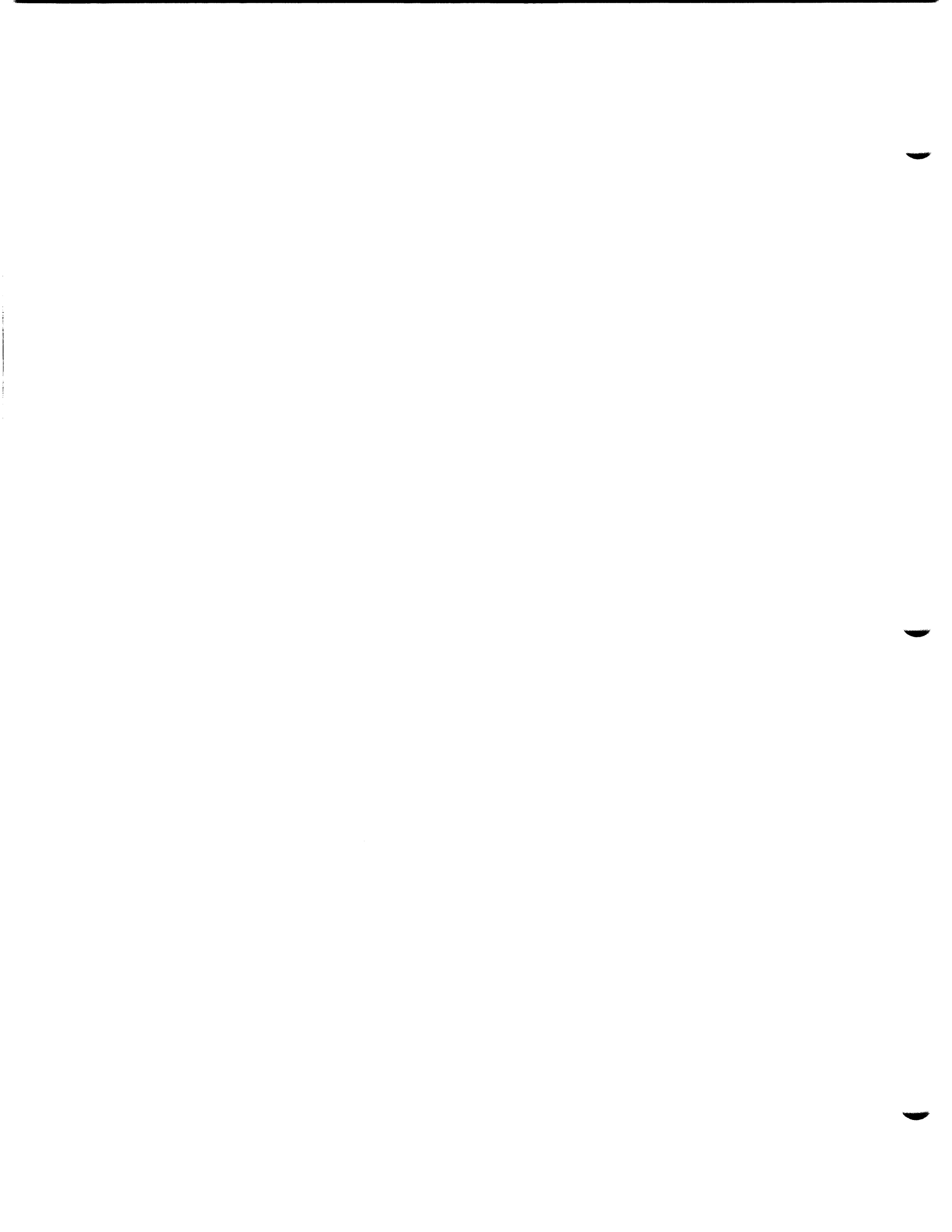


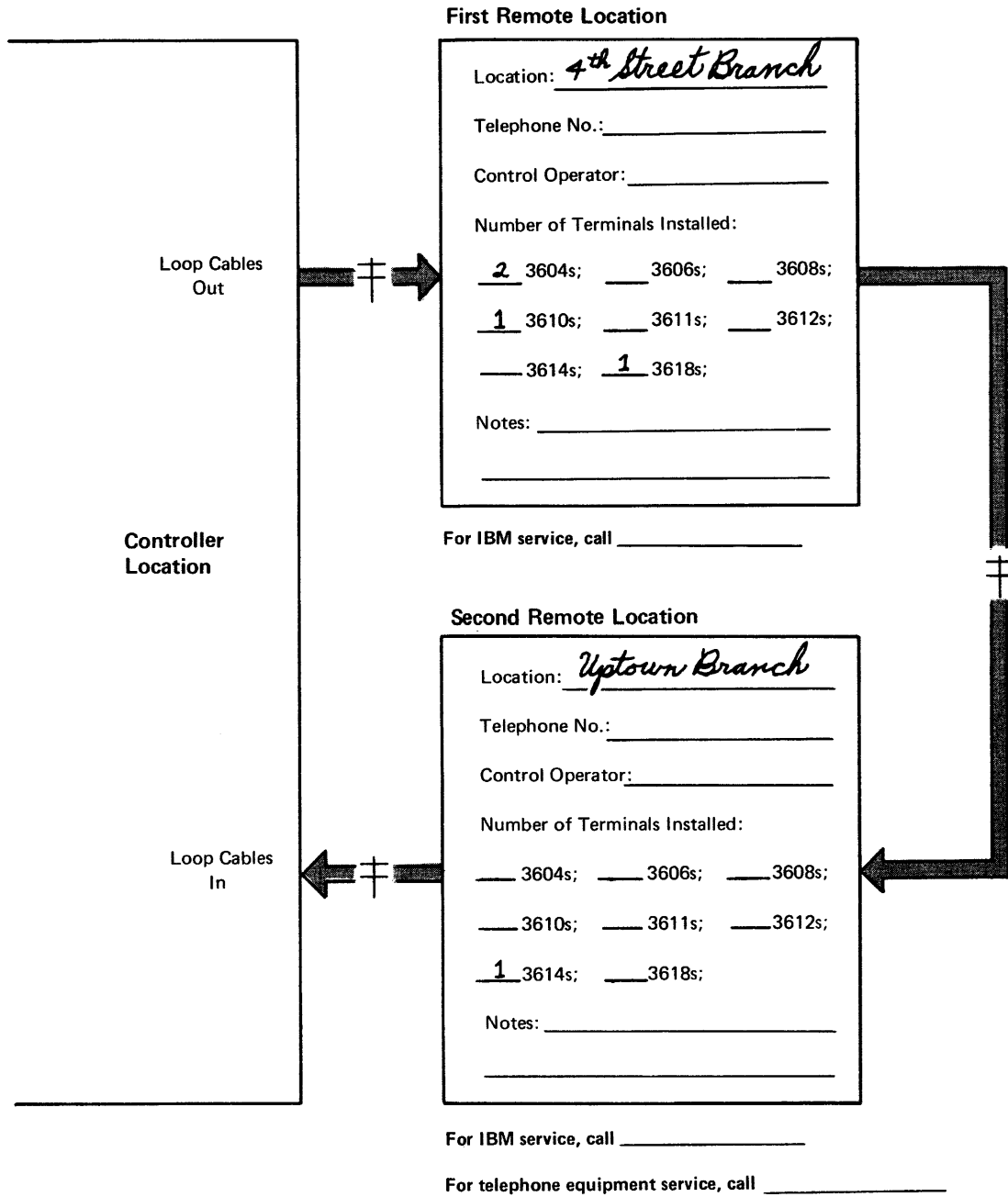
*Note:* The terminals in your branch are connected to the loop through a modem unit (a terminal that has a modem or can be attached to a modem). The terminals that can have a modem are: a 3604 Model 2, 3, or 4 and any 3614 model. A 3604 modem unit has a TEST UNIT/DSBL UNIT switch; a 3614 modem unit has a TEST UNIT switch. In addition, the modem unit models have telephone jacks.

**Legend:**  
 ADD = terminal address. This is the address (assigned by means of the terminal address switches) used by the controller to communicate with the terminal. Each terminal or terminal group on a loop must have a unique address.  
 CUA = controller control unit address. This is the address used by the host to communicate with the controller.  
 ID = customer identification for the terminal. The customer may, if desired, use the address (ADD) of the terminal as the ID.  
 Loop No. = controller loop number (1 to 8).  
 Loop Speed = the speed assigned to the loop. The loop speed switches for all terminals on a loop must be set to the same speed and must match the speed of the controller.  
 Loop Input Connection From = the unit (controller, 3604-2, -3, -4 with modem, or 3614 with modem) from which the communication path for this remote loop comes from. This communication path starts at a controller.  
 Loop Output Connection To = the unit (controller, 3604-2, -3, -4 with modem, or 3614 with modem) to which the communication path for this remote loop goes to. This communication path will end at a controller.

**Multi-Location Remote Loop Description Sheet**

This page precedes the Remote Loop Location Directory sheets.





**Legend:**

CUA = controller control unit address. This is the address used by the host to communicate with the controller.

ID = customer identification for the controller. The customer may, if desired, use the CUA as the ID.

Loop No. = controller loop number (1 to 8).

Loop Speed = the speed assigned to the loop. The loop speed switches for all terminals on a loop must be set to the same speed and must match the speed of the controller.

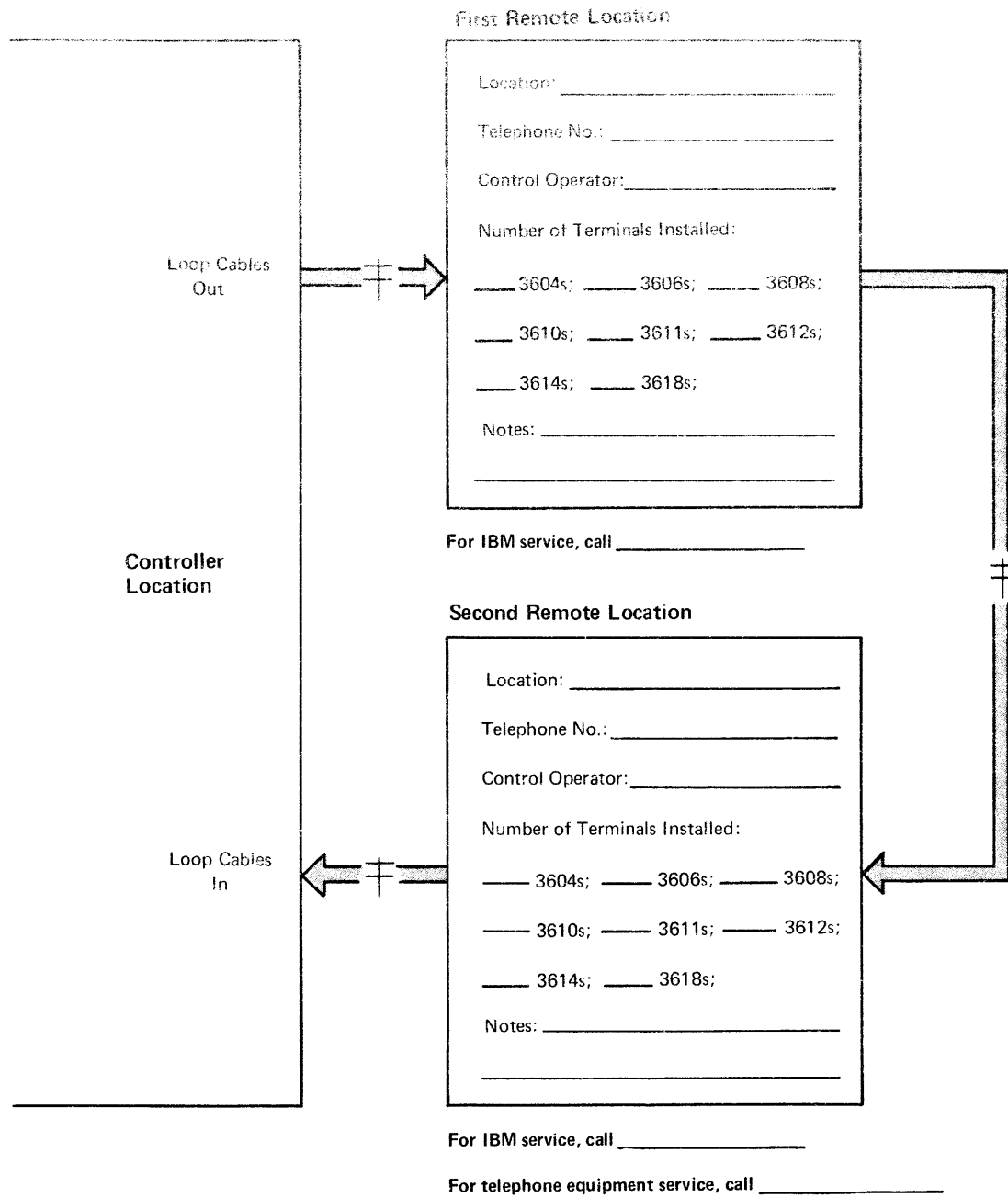
SAMPLE

Loop No. 2

Controller CUA 01 ID A

Loop Speed 1200 lps

Remote Loop Location Directory



Legend:

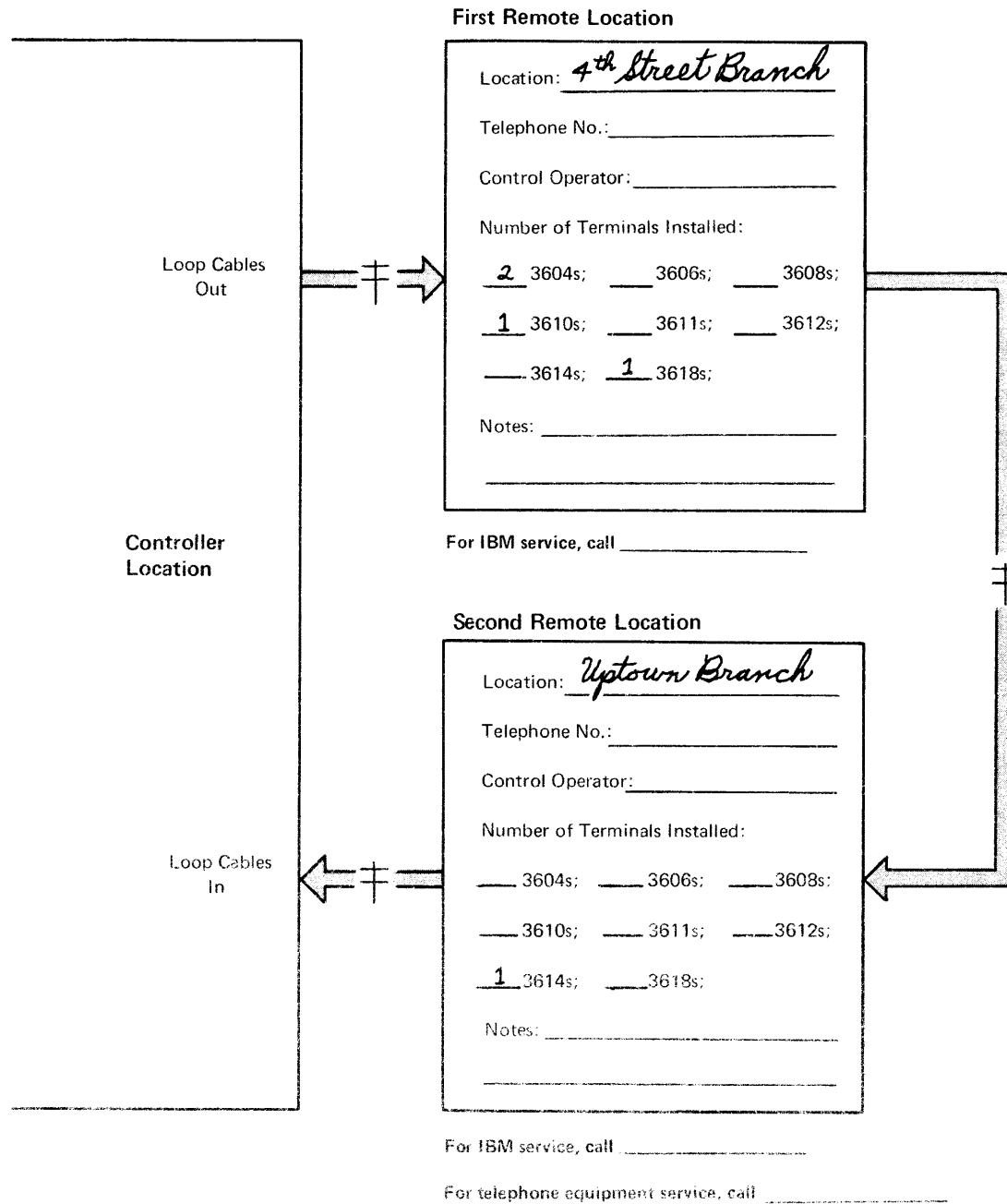
- CUA = controller control unit address. This is the address used by the host to communicate with the controller.
- ID = customer identification for the controller. The customer may, if desired, use the CUA as the ID.
- Loop No. = controller loop number (1 to 8).
- Loop Speed = the speed assigned to the loop. The loop speed switches for all terminals on a loop must be set to the same speed and must match the speed of the controller.

Loop No. \_\_\_\_\_

Controller CUA \_\_\_\_ ID \_\_\_\_\_

Loop Speed \_\_\_\_\_

**Remote Loop Location Directory**



Legend:

- CUA = controller control unit address. This is the address used by the host to communicate with the controller.
- ID = customer identification for the controller. The customer may, if desired, use the CUA as the ID.
- Loop No. = controller loop number (1 to 8).
- Loop Speed = the speed assigned to the loop. The loop speed switches for all terminals on a loop must be set to the same speed and must match the speed of the controller.

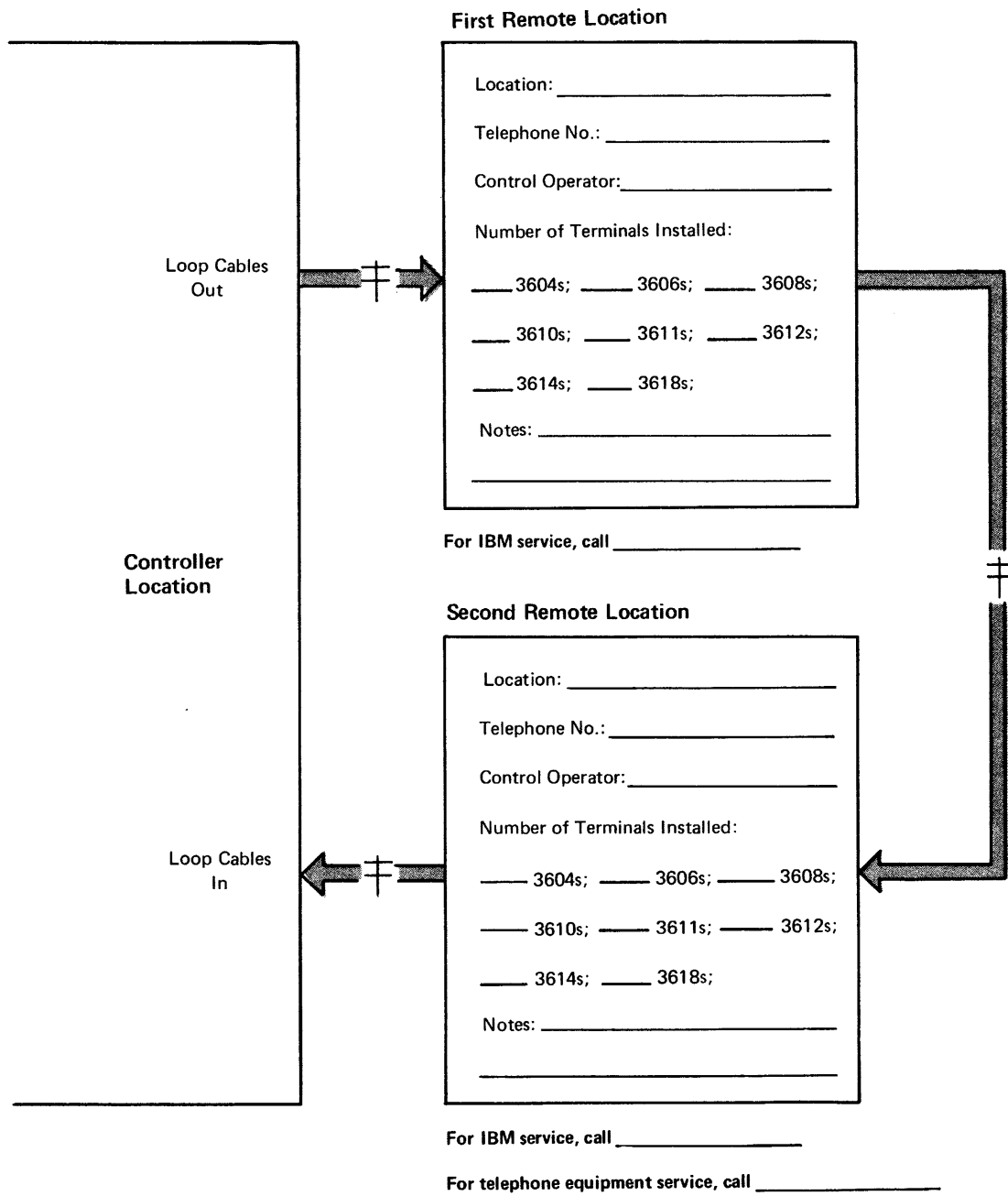
SAMPLE

Loop No. 2

Controller CUA 01 ID A

Loop Speed 1200 lps

Remote Loop Location Directory



Legend:

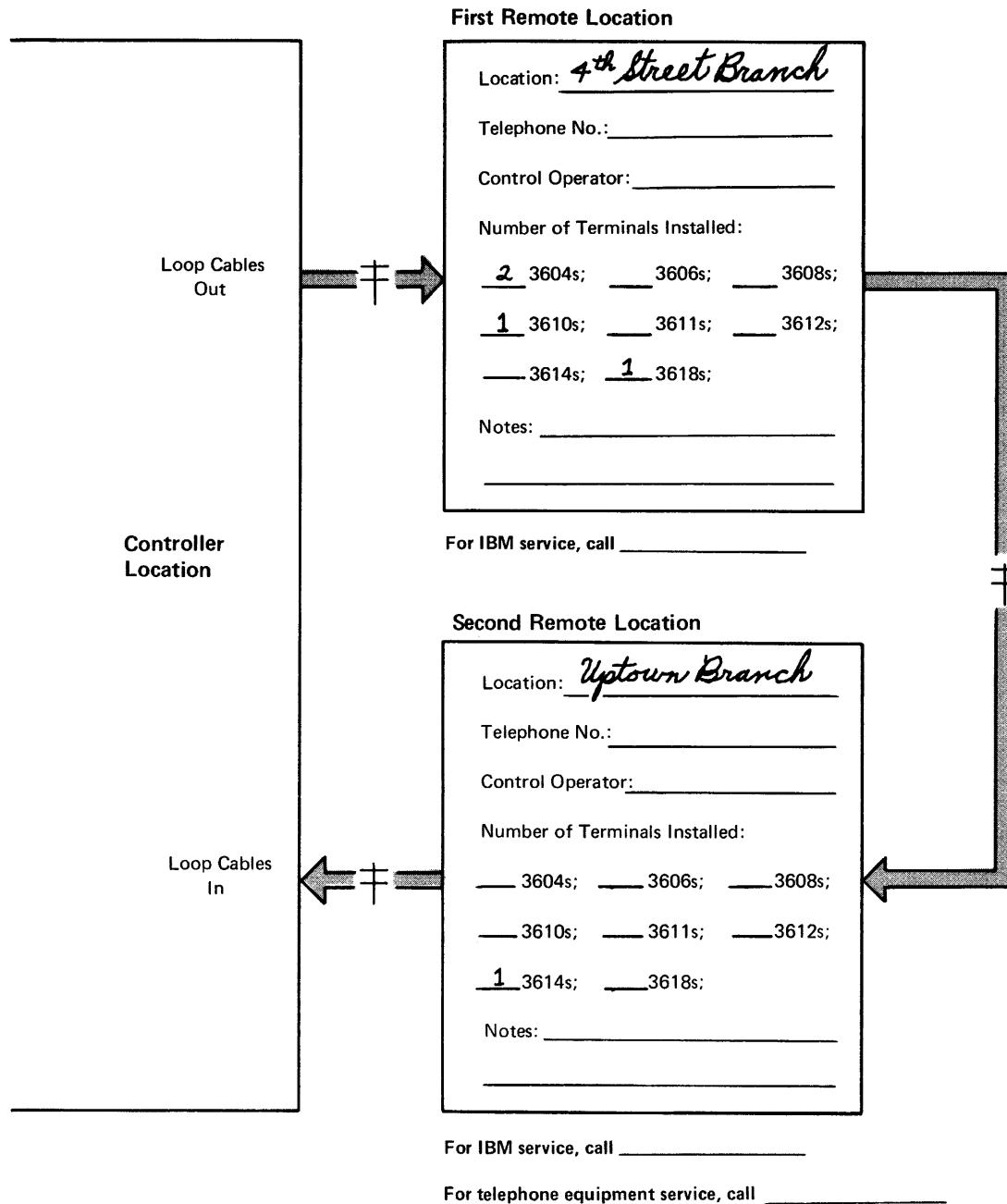
- CUA = controller control unit address. This is the address used by the host to communicate with the controller.
- ID = customer identification for the controller. The customer may, if desired, use the CUA as the ID.
- Loop No. = controller loop number (1 to 8).
- Loop Speed = the speed assigned to the loop. The loop speed switches for all terminals on a loop must be set to the same speed and must match the speed of the controller.

Loop No. \_\_\_\_\_

Controller CUA \_\_\_ ID \_\_\_\_\_

Loop Speed \_\_\_\_\_

**Remote Loop Location Directory**



Legend:

- CUA = controller control unit address. This is the address used by the host to communicate with the controller.
- ID = customer identification for the controller. The customer may, if desired, use the CUA as the ID.
- Loop No. = controller loop number (1 to 8).
- Loop Speed = the speed assigned to the loop. The loop speed switches for all terminals on a loop must be set to the same speed and must match the speed of the controller.

SAMPLE

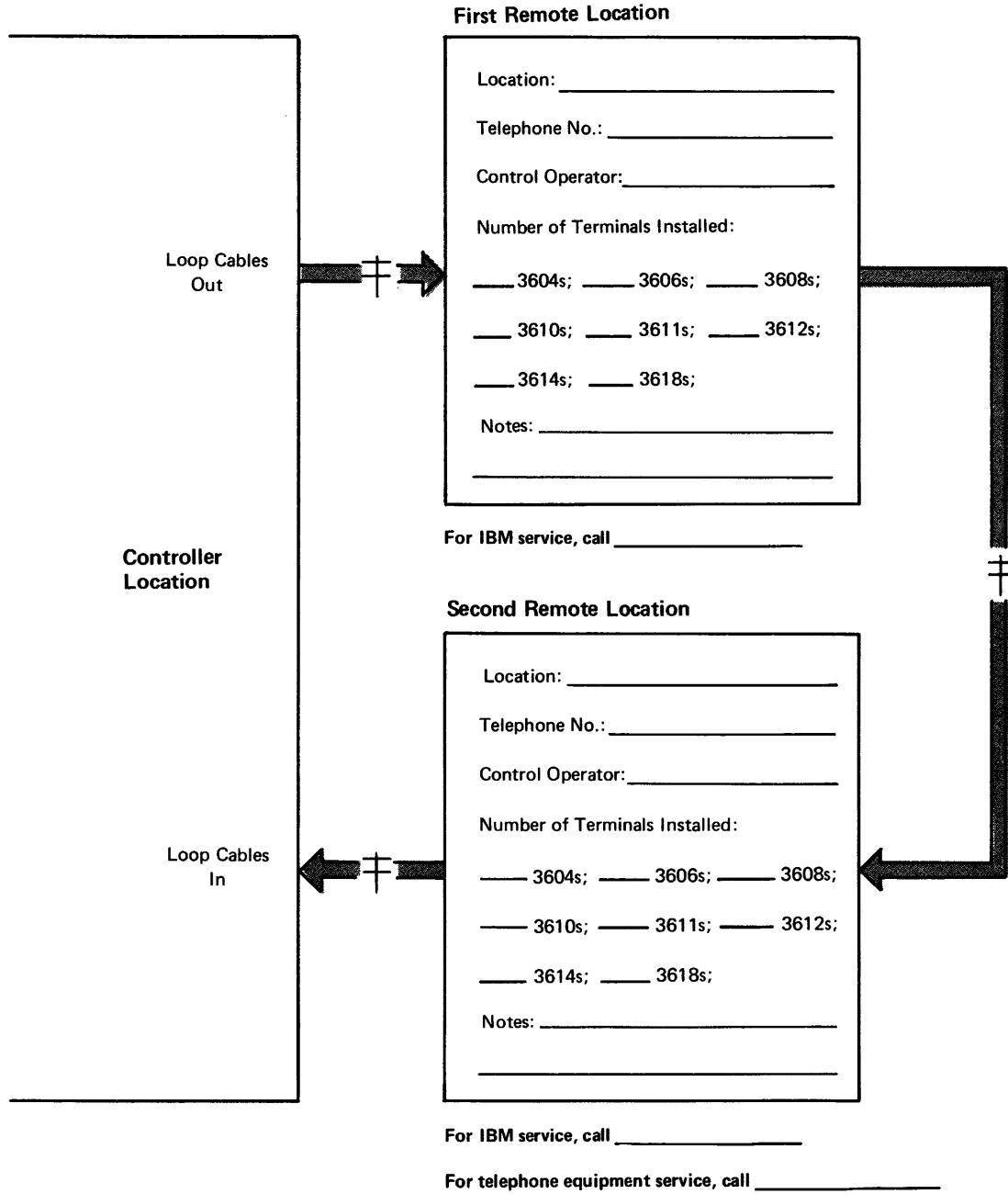
Loop No. 2

Controller CUA 01 ID A

Loop Speed 1200 bps

Remote Loop Location Directory





Legend:

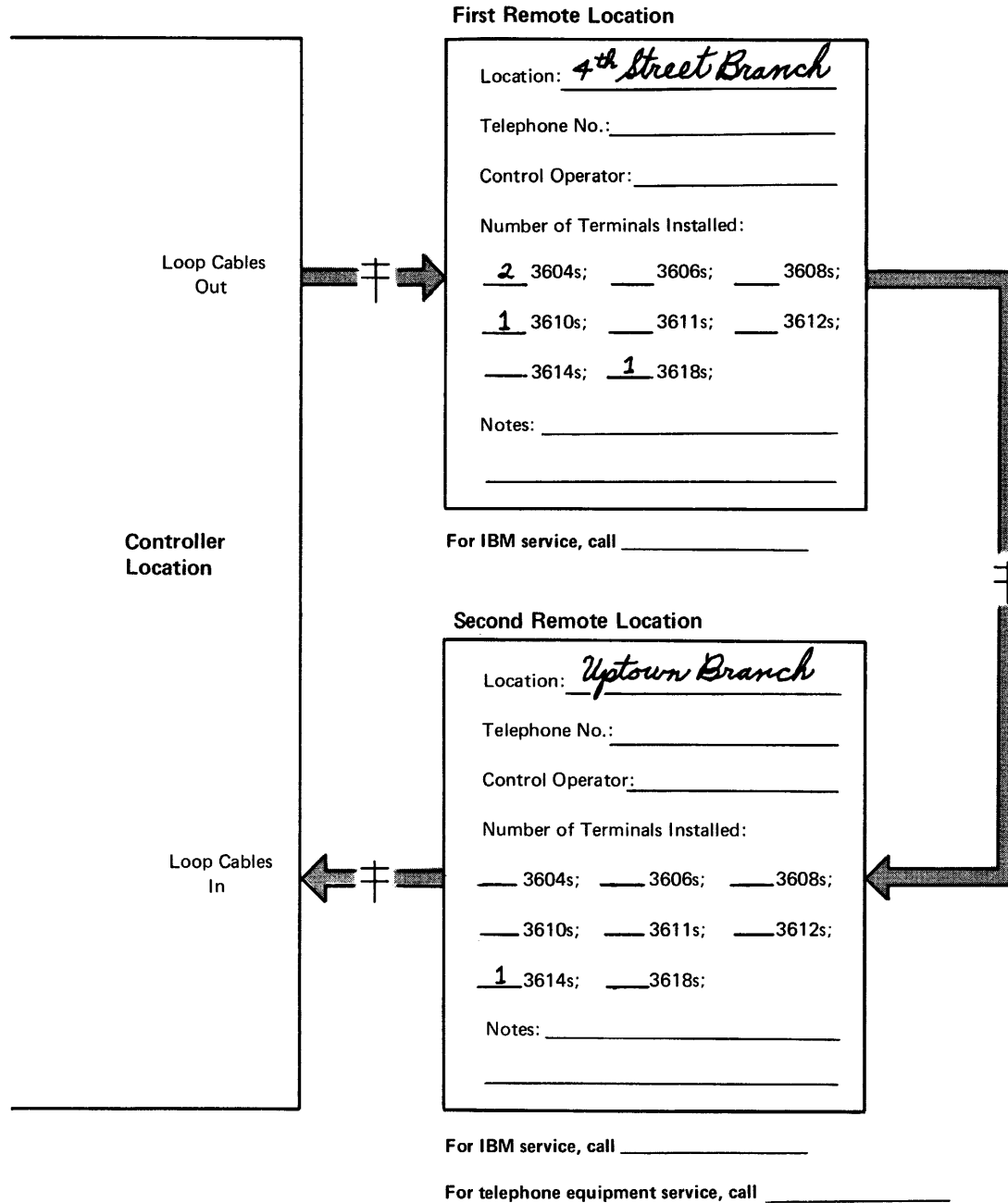
- CUA = controller control unit address. This is the address used by the host to communicate with the controller.
- ID = customer identification for the controller. The customer may, if desired, use the CUA as the ID.
- Loop No. = controller loop number (1 to 8).
- Loop Speed = the speed assigned to the loop. The loop speed switches for all terminals on a loop must be set to the same speed and must match the speed of the controller.

Loop No. \_\_\_\_\_

Controller CUA \_\_\_ ID \_\_\_\_\_

Loop Speed \_\_\_\_\_

**Remote Loop Location Directory**



Legend:

- CUA = controller control unit address. This is the address used by the host to communicate with the controller.
- ID = customer identification for the controller. The customer may, if desired, use the CUA as the ID.
- Loop No. = controller loop number (1 to 8).
- Loop Speed = the speed assigned to the loop. The loop speed switches for all terminals on a loop must be set to the same speed and must match the speed of the controller.

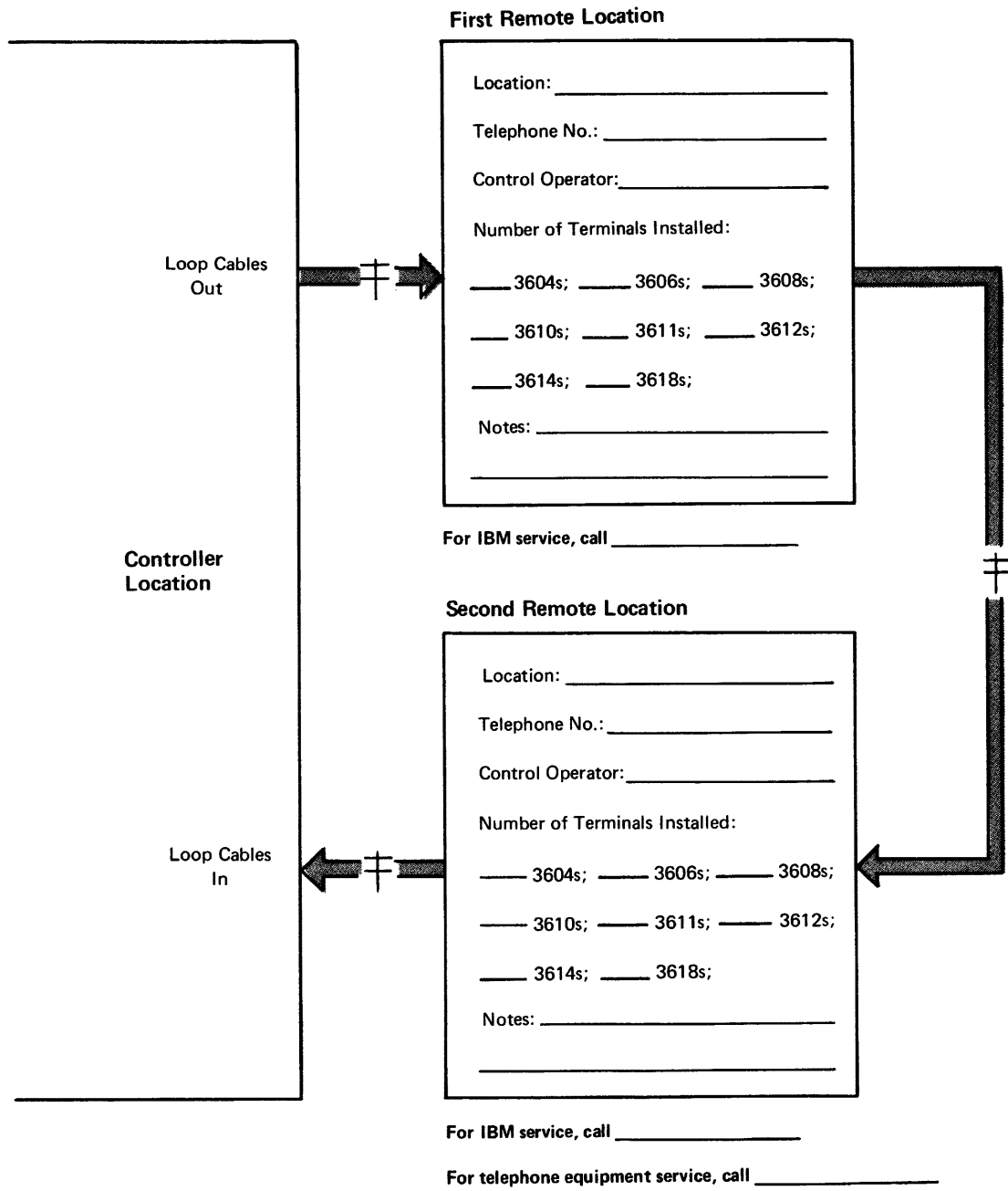
SAMPLE

Loop No. 2

Controller CUA 01 ID A

Loop Speed 1200 lps

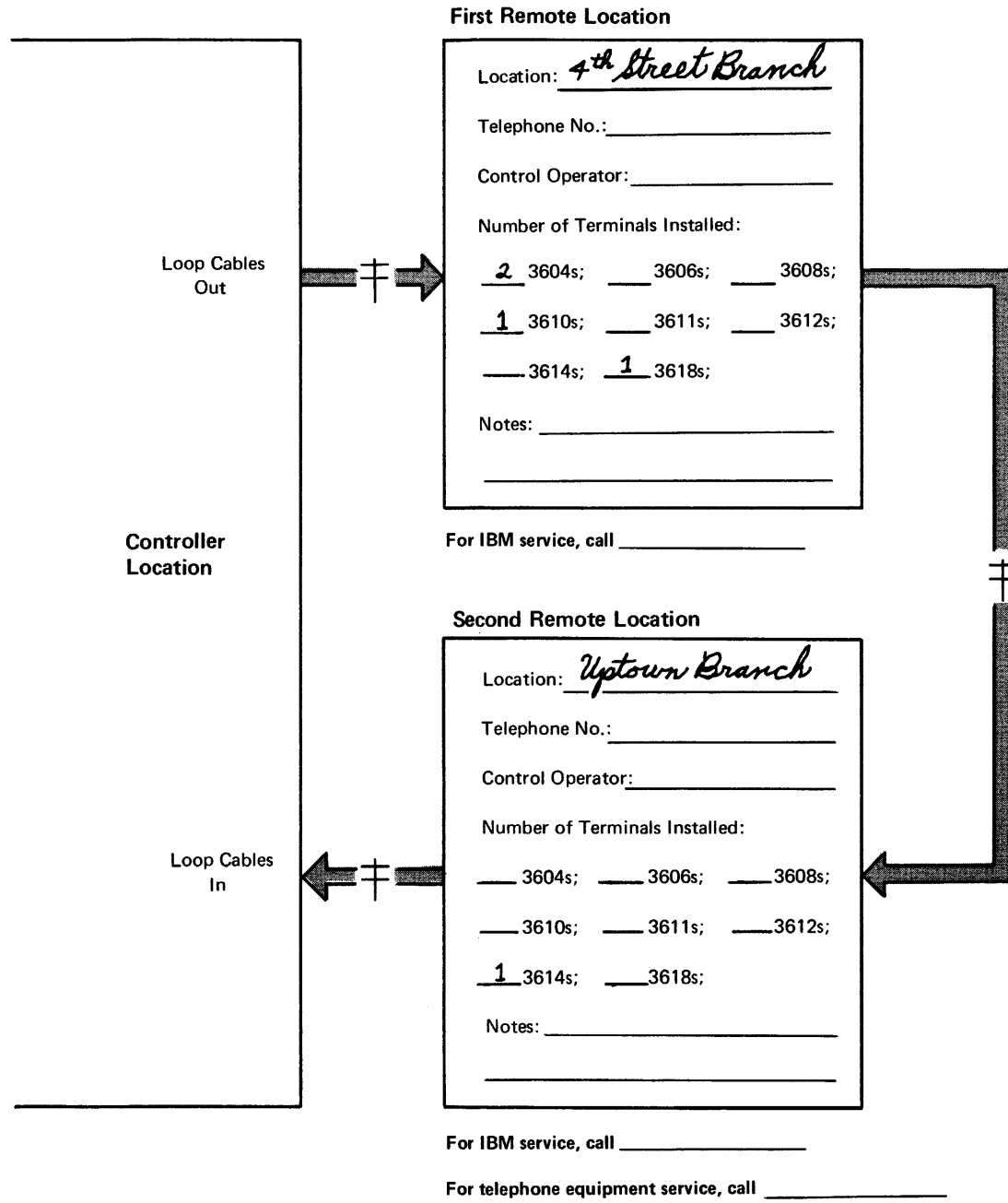
Remote Loop Location Directory



- Legend:
- CUA = controller control unit address. This is the address used by the host to communicate with the controller.
  - ID = customer identification for the controller. The customer may, if desired, use the CUA as the ID.
  - Loop No. = controller loop number (1 to 8).
  - Loop Speed = the speed assigned to the loop. The loop speed switches for all terminals on a loop must be set to the same speed and must match the speed of the controller.

Loop No. \_\_\_\_\_  
 Controller CUA \_\_\_ ID \_\_\_  
 Loop Speed \_\_\_\_\_

**Remote Loop Location Directory**



- Legend:
- CUA = controller control unit address. This is the address used by the host to communicate with the controller.
  - ID = customer identification for the controller. The customer may, if desired, use the CUA as the ID.
  - Loop No. = controller loop number (1 to 8).
  - Loop Speed = the speed assigned to the loop. The loop speed switches for all terminals on a loop must be set to the same speed and must match the speed of the controller.

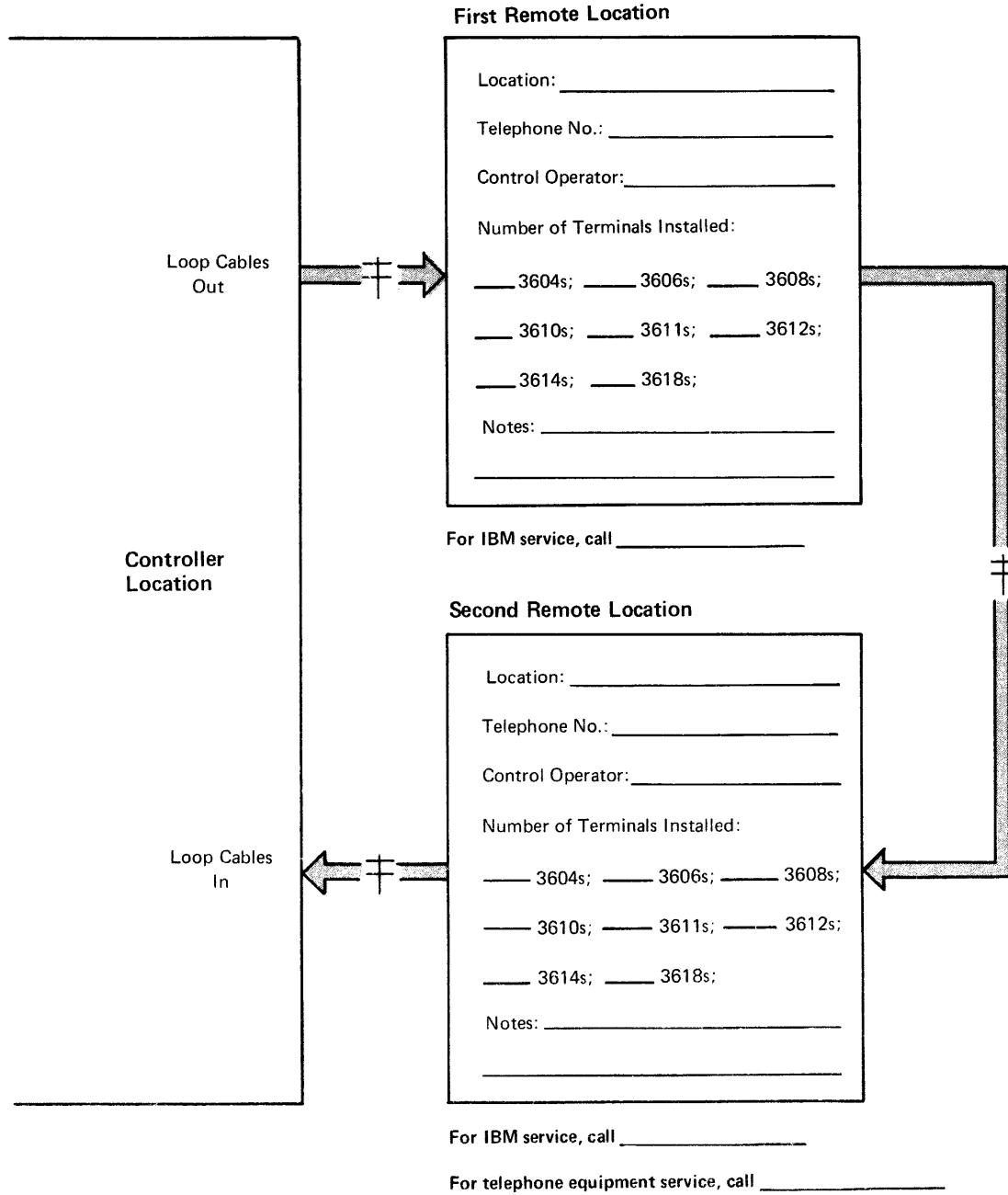
SAMPLE

Loop No. 2

Controller CUA 01 ID A

Loop Speed 1200 lps

Remote Loop Location Directory



Legend:

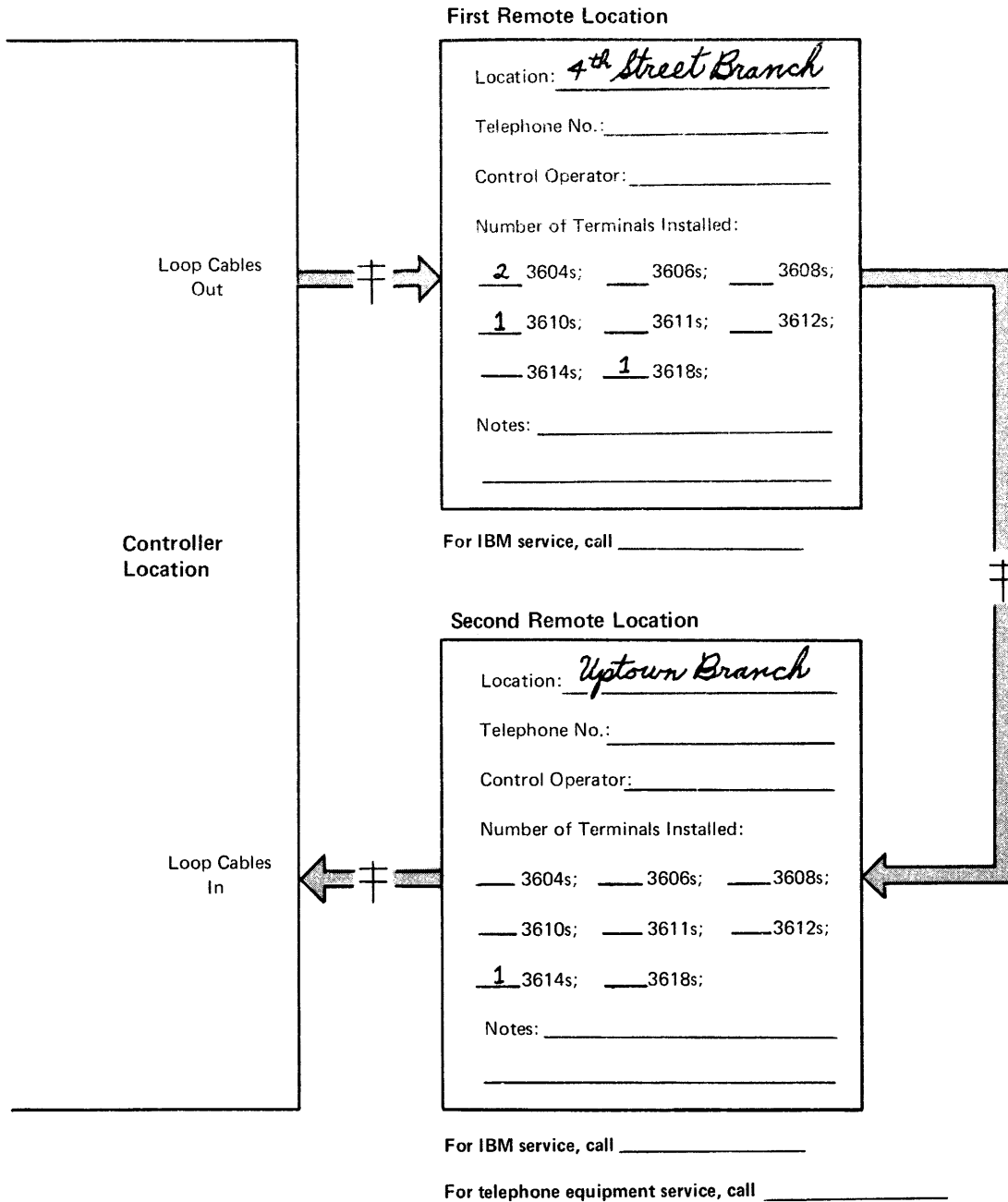
- CUA = controller control unit address. This is the address used by the host to communicate with the controller.
- ID = customer identification for the controller. The customer may, if desired, use the CUA as the ID.
- Loop No. = controller loop number (1 to 8).
- Loop Speed = the speed assigned to the loop. The loop speed switches for all terminals on a loop must be set to the same speed and must match the speed of the controller.

Loop No. \_\_\_\_\_

Controller CUA \_\_\_ ID \_\_\_\_\_

Loop Speed \_\_\_\_\_

**Remote Loop Location Directory**



Legend:

- CUA = controller control unit address. This is the address used by the host to communicate with the controller.
- ID = customer identification for the controller. The customer may, if desired, use the CUA as the ID.
- Loop No. = controller loop number (1 to 8).
- Loop Speed = the speed assigned to the loop. The loop speed switches for all terminals on a loop must be set to the same speed and must match the speed of the controller.

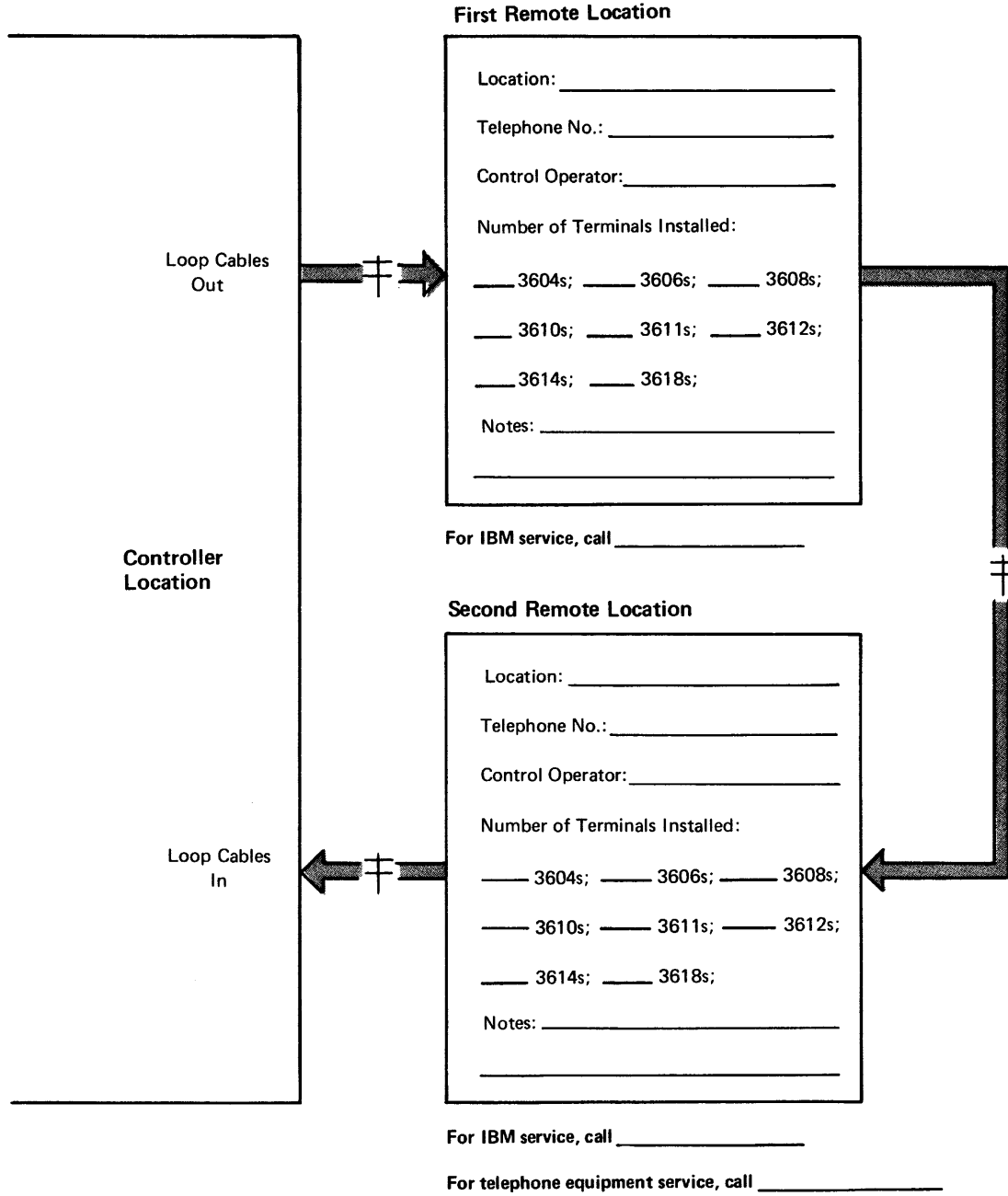
SAMPLE

Loop No. 2

Controller CUA 01 ID A

Loop Speed 1200 bps

Remote Loop Location Directory



Legend:

- CUA = controller control unit address. This is the address used by the host to communicate with the controller.
- ID = customer identification for the controller. The customer may, if desired, use the CUA as the ID.
- Loop No. = controller loop number (1 to 8).
- Loop Speed = the speed assigned to the loop. The loop speed switches for all terminals on a loop must be set to the same speed and must match the speed of the controller.

Loop No. \_\_\_\_\_  
 Controller CUA \_\_\_ ID \_\_\_\_\_  
 Loop Speed \_\_\_\_\_

**Remote Loop Location Directory**

## **Contents – Number Systems and Glossary**

### Number Systems

- Decimal Number System

- Binary Number System

- Hexadecimal Number System

### Glossary

This page follows the Number Systems and Glossary tab.

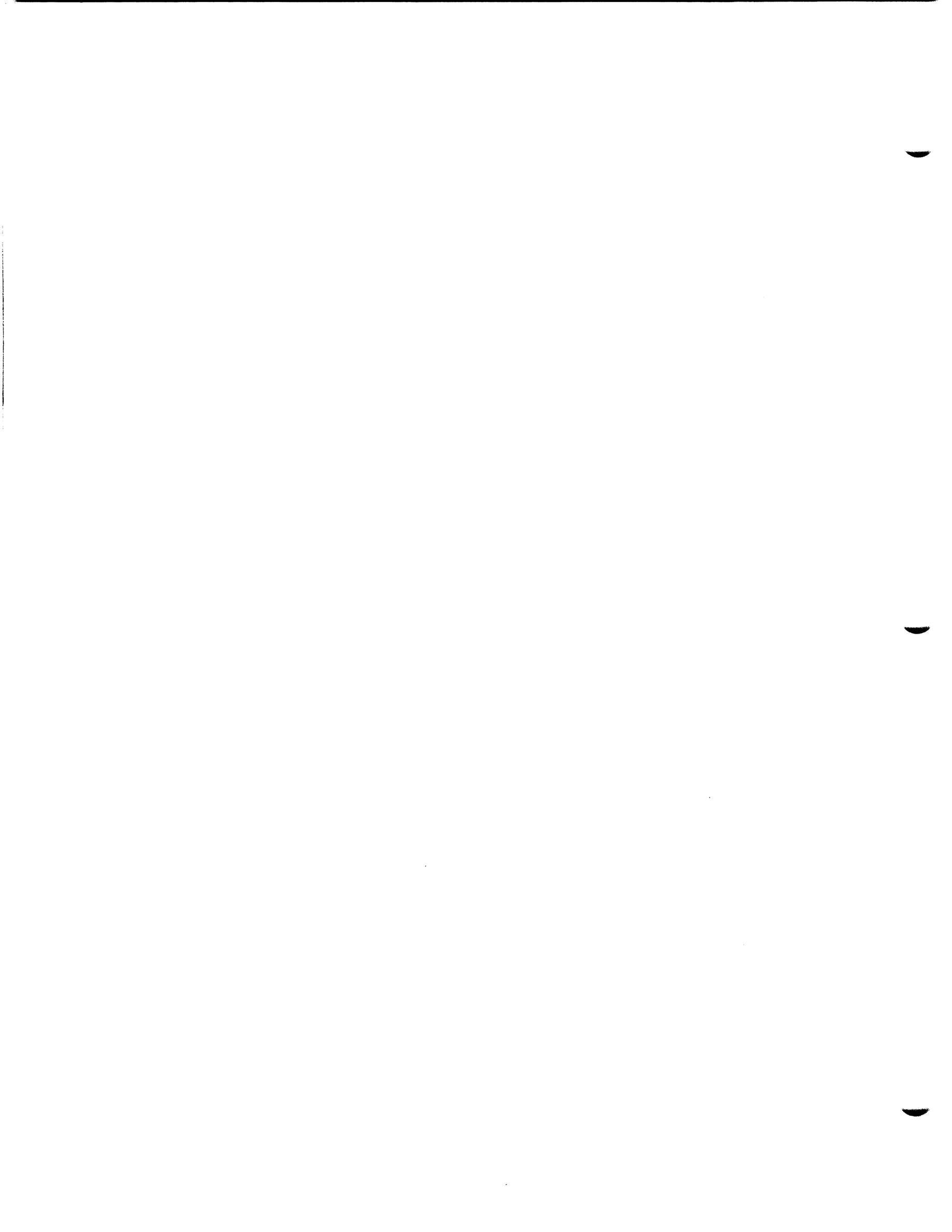




## Contents – Number Systems

|                                     |   |
|-------------------------------------|---|
| Decimal Number System . . . . .     | 1 |
| Binary Number System . . . . .      | 2 |
| Hexadecimal Number System . . . . . | 4 |

This page precedes the Number Systems and Glossary, Number Systems page 1.



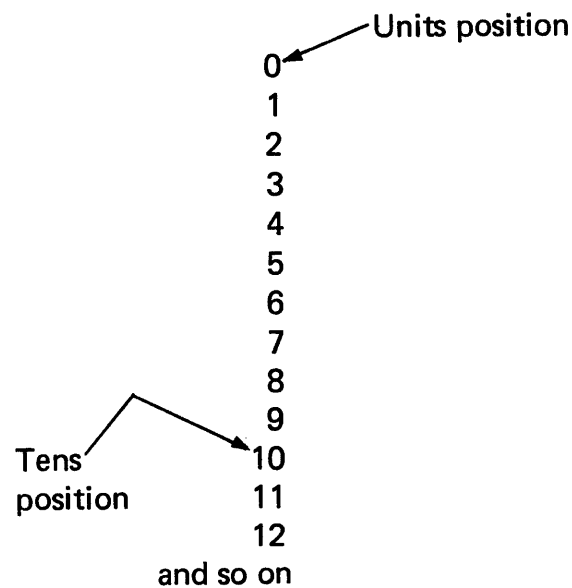
Place all Number Systems and Glossary pages after this tab.

## Number Systems

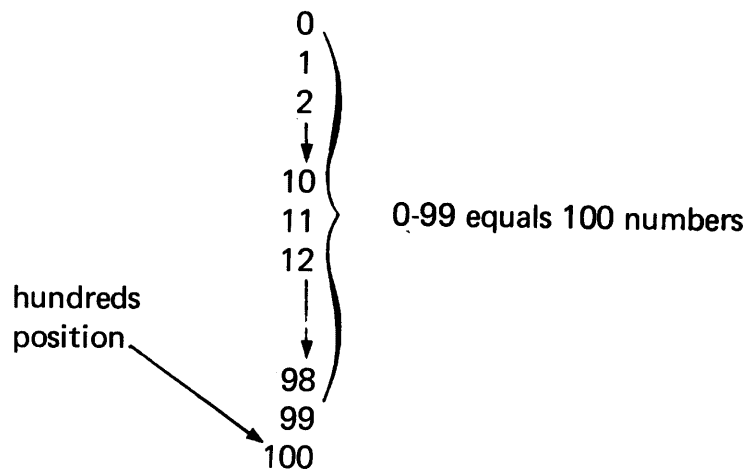
Three different number systems are used in the 3600 system. The controller, terminals, and central site computer perform their internal operations using the *binary* number system. But you use the *decimal* or *hexadecimal* number system to more easily communicate with the system. For example, the control operator commands that you use may require that you enter data either in decimal or hexadecimal. You may not have to figure out the hexadecimal characters to be entered (they may already be prepared for you by your institution), but you may wonder what hexadecimal is. This appendix explains the hexadecimal number system and why it is used. Let's start with the decimal number system that we all know and use.

### DECIMAL NUMBER SYSTEM

The decimal number system is made up of 10 symbols: 0, 1, 2, 3, 4, 5, 6, 7, 8, and 9. Counting starts in the units position with 0 and proceeds through the next nine symbols. When 9 is reached, there are no more symbols; therefore, a 1 is placed in the position to the left (tens position) and the count resumes with a 0 in the units position:

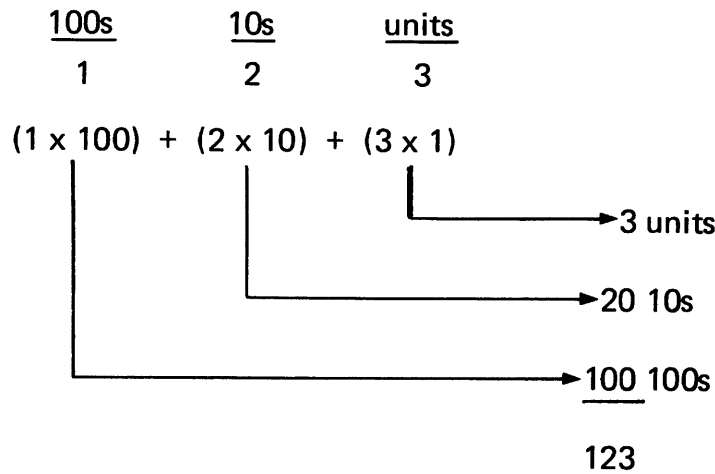


Continuing the count, it takes 100 numbers before we need a third position (the hundreds position) for a three-digit number.



It takes 1000 numbers, 0-999, before we need a fourth position (the thousands position) for a four-digit number, and so on.

Because there are 10 different symbols, 10 is the base of the decimal number system, and each new position has a value of 10 times the previous position. For example, the decimal number 123 breaks down as follows:



## BINARY NUMBER SYSTEM

The 3600 system terminals use *binary* electronic circuits; that is, circuits that can be in only *one of two* conditions: on or off. Therefore, to represent data in the terminals we use the *binary* number system, which has only two symbols, 0 and 1. Counting is started in the same way as in the decimal system, with 0 for zero and 1 for one. At this point, there are no more unique symbols to be used. Therefore, to express a 2 we place a 1 in the next position to the left and start again with a 0 in the original position. Thus binary 10 equals 2 in the decimal system. Counting is continued with a new position every time a 2 is reached instead of every time a 10 is reached. Counting in the binary system is as follows:

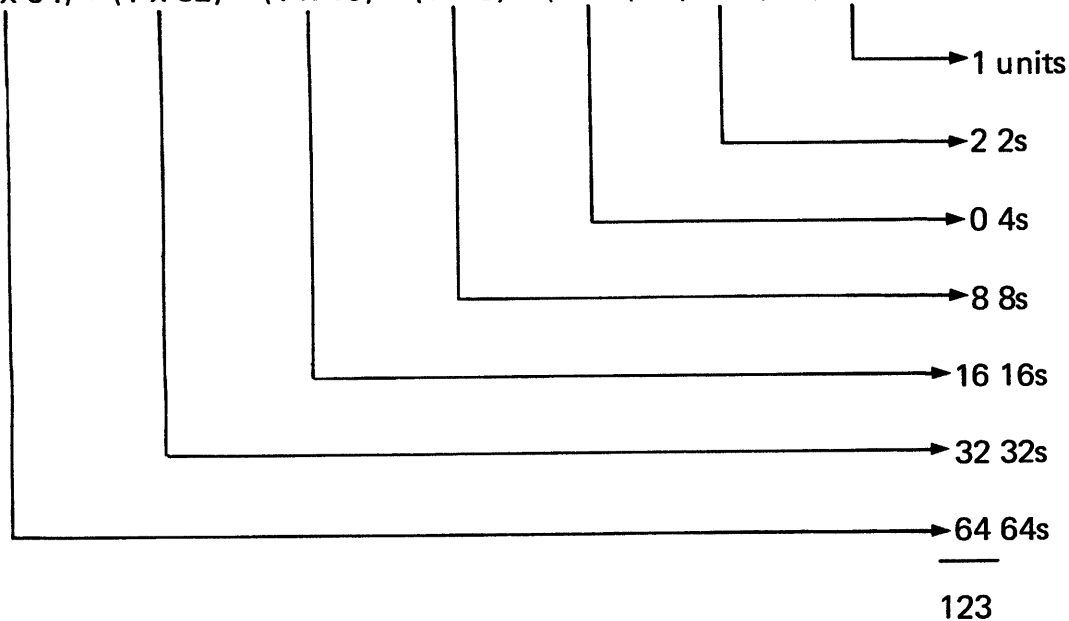
| <u>Binary</u> | <u>Decimal</u> |
|---------------|----------------|
| 0             | 0              |
| 1             | 1              |
| 10            | 2              |
| 11            | 3              |
| 100           | 4              |
| 101           | 5              |
| 110           | 6              |
| 111           | 7              |
| 1000          | 8              |
| 1001          | 9              |
| 1010          | 10             |
| 1011          | 11             |

and so on.

Because there are two different symbols, 2 is the base of the binary number system, and each new position has a value of 2 times the previous position. The various positions do not have the meanings of units, 10s, 100s, 1000s, etc., as in the decimal number system, but signify units, 2s, 4s, 8s, 16s, etc. For example, using the binary number system, the decimal number 123 is represented as 1111011, which breaks down as follows:

| <u>64s</u> | <u>32s</u> | <u>16s</u> | <u>8s</u> | <u>4s</u> | <u>2s</u> | <u>units</u> |
|------------|------------|------------|-----------|-----------|-----------|--------------|
| 1          | 1          | 1          | 1         | 0         | 1         | 1            |

$$(1 \times 64) + (1 \times 32) + (1 \times 16) + (1 \times 8) + (0 \times 4) + (1 \times 2) + (1 \times 1)$$



Thus, decimal 123 equals 1111011 in binary.

Binary digit positions are called *bits*. A bit is either a 0 or a 1. For ease of reading and writing, a binary number is divided into groups of four bits. Thus in our example, the binary number would be shown as: 0111 1011. (We add a 0 in the left group to make four bits.) Two 4-bit binary groups (eight binary bits) are called a *byte*.

## HEXADECIMAL NUMBER SYSTEM

From the above discussion of binary numbers you can see that they can become quite large. In fact, binary numbers are more than three times as long as the corresponding decimal numbers. This increased length is a problem when talking about or writing binary numbers or when entering them into a system; you can't easily speak, read, write, or enter a long string of 1s and 0s. A shorthand system is necessary, and the hexadecimal number system is just that.

The hexadecimal system has 16 symbols: 0, 1, 2, 3, 4, 5, 6, 7, 8, 9, A, B, C, D, E, and F. Counting is performed as in the decimal and binary systems. When the last unique symbol (F) is reached, a 1 is placed in the next position to the left and counting continues with a 0 in the original position, as follows:

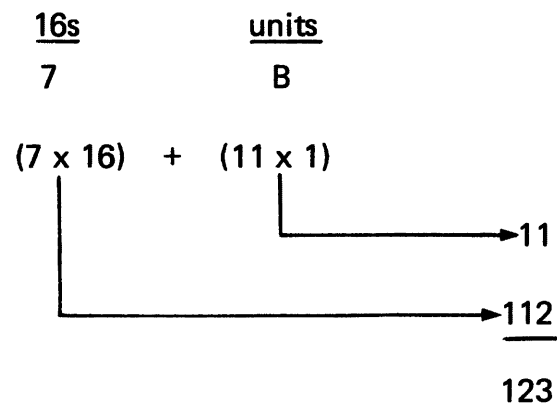
|   |    |    |    |
|---|----|----|----|
| 0 | 10 | 20 | A0 |
| 1 | 11 | 21 | A1 |
| 2 | 12 | 22 | A2 |
| 3 | 13 | 23 |    |
| 4 | 14 |    |    |
| 5 | 15 |    |    |
| 6 | 16 |    |    |
| 7 | 17 |    |    |
| 8 | 18 |    |    |
| 9 | 19 |    |    |
| A | 1A | 9A |    |
| B | 1B | 9B |    |
| C | 1C | 9C |    |
| D | 1D | 9D |    |
| E | 1E | 9E |    |
| F | 1F | 9F |    |

↓  
and so on

Because there are 16 different symbols, 16 is the base of the hexadecimal number system, and each new position has a value of 16 times the previous position. The various positions do not have the meaning of units, 10s, 100s, etc., as in the decimal number system, nor the meaning of units, 2s, 4s, etc., as in the binary number system, but signify units, 16s, 256s, etc.

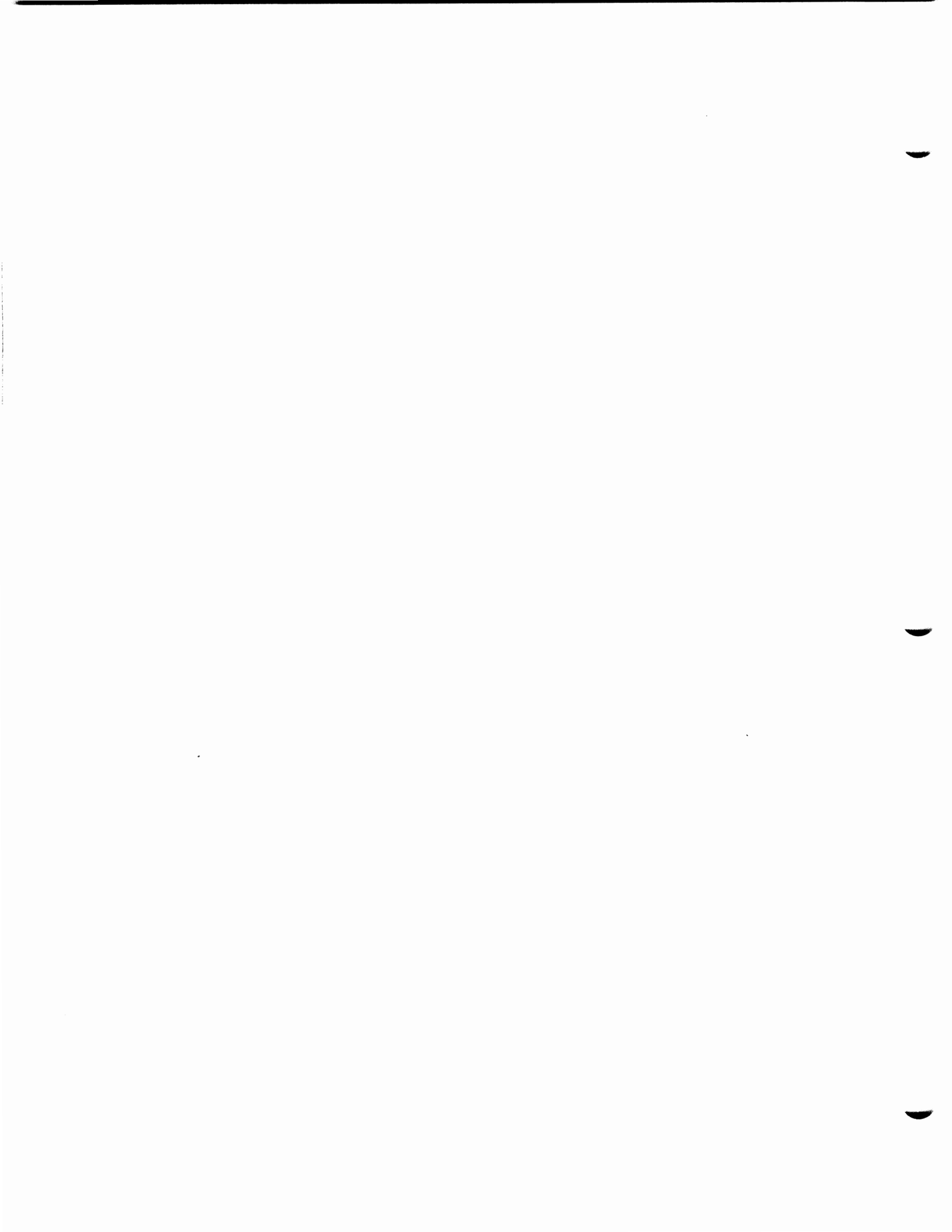


Thus, decimal 123 equals 7B in hexadecimal:

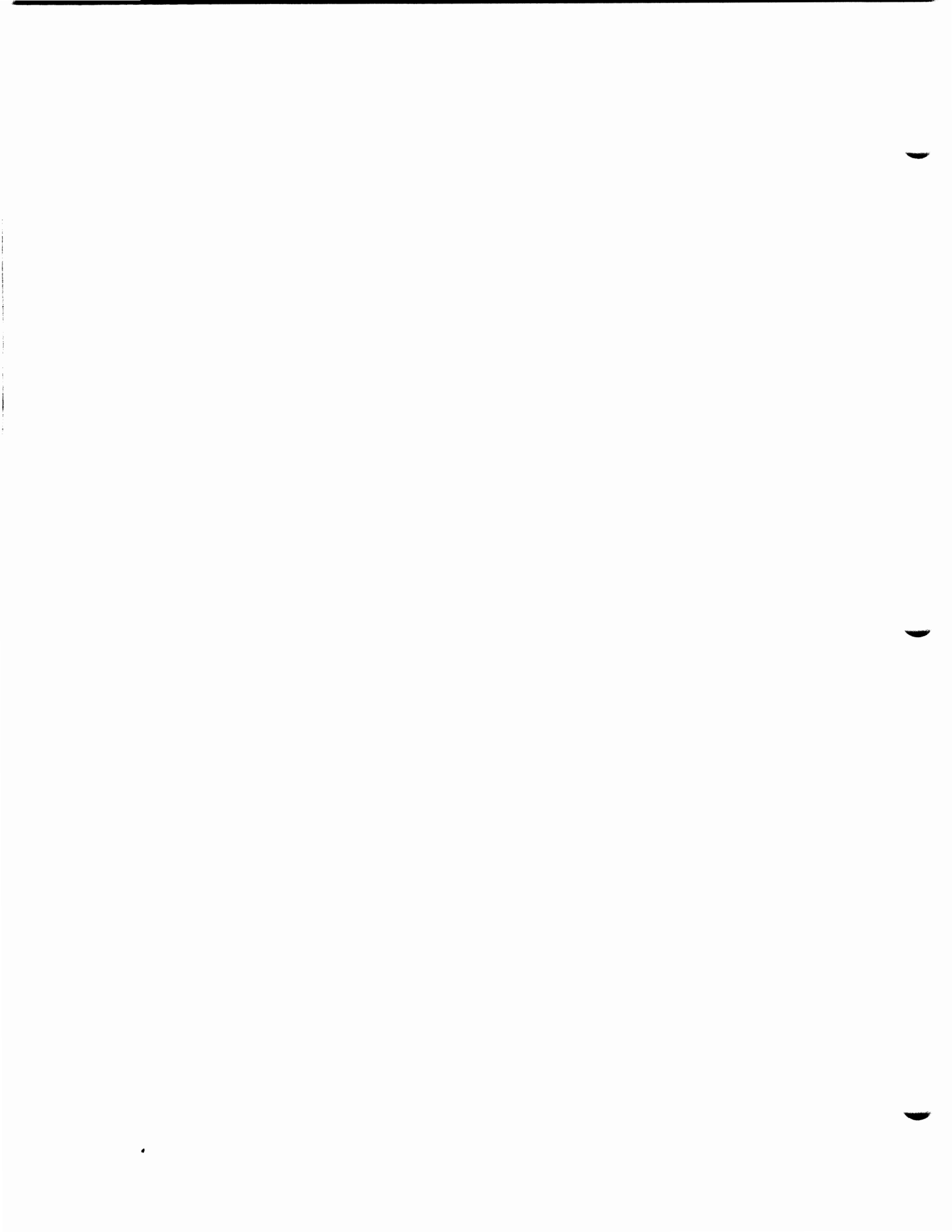


One hexadecimal symbol represents four binary bits. Thus an eight-bit binary byte can be represented by two hexadecimal symbols. The relationship between the decimal, binary, and hexadecimal number systems is as follows:

| <u>Decimal</u> | <u>Hexadecimal</u> | <u>Binary</u> |
|----------------|--------------------|---------------|
| 0              | 0                  | 0000          |
| 1              | 1                  | 0001          |
| 2              | 2                  | 0010          |
| 3              | 3                  | 0011          |
| 4              | 4                  | 0100          |
| 5              | 5                  | 0101          |
| 6              | 6                  | 0110          |
| 7              | 7                  | 0111          |
| 8              | 8                  | 1000          |
| 9              | 9                  | 1001          |
| 10             | A                  | 1010          |
| 11             | B                  | 1011          |
| 12             | C                  | 1100          |
| 13             | D                  | 1101          |
| 14             | E                  | 1110          |
| 15             | F                  | 1111          |



This page precedes the Number Systems and Glossary, Glossary page 1.



# Glossary

## A

**advance key:** On a 3604, a function key that moves the cursor forward without any change to the data already entered.

**alphanumeric characters:** The letters A through Z, the digits 0 through 9, and any other special character, such as the punctuation marks on the 3604 alphanumeric keyboard.

**application program:** (1) A program written for or by a user that applies to his own work. (2) In the 3600 system, application programs can be written for the host computer or for the controller.

**assign a test component:** To enter a command at a 3604 keyboard to designate the terminal component that will be tested by subsequent keyboard commands. This assignment remains in effect until: (1) the control operator assigns a different test component, (2) the control operator logs off, or (3) the controller is reset.

**assign an output printer:** To enter a command at a 3604 keyboard to designate the printer (or display) that will be the output printer. (Additional commands are entered to cause the output printer to print/display specific information during the time the control operator is logged on.) This assignment remains in effect until: (1) the control operator assigns a different output printer, (2) the control operator logs off, or (3) the controller is reset.

**auxiliary storage:** (1) Data storage other than main storage. (2) In the 3600 system, auxiliary storage in the controller consists of a diskette.

## B

**backspace key:** On a 3604, a function key that moves the cursor backward without any change to the data already entered.

**backup operating diskette:** A second diskette containing the same configuration image and data as the operating diskette. See *operating diskette*.

**base address:** See *terminal base address*.

## C

**central site:** The location that contains the host computer. See *host computer*.

**character:** A letter, digit, or special symbol.

**cold start:** A startup of the controller that erases the data in the diskette temporary files. Contrast *with warm start*.

**communication link:** (1) In general, the physical means of connecting one location to another for the purpose of transmitting and receiving information. (2) In the 3600 system, the communication link consists of an external or integrated modem at each location and a telephone line that connects the locations.

**component:** (1) In general, a part of a larger unit. (2) In the 3600 system, a shortened name for a terminal component. See *terminal component*.

**component address:** (1) The fixed electronic address of a terminal component (not the terminal itself). (2) In the 3600 system, the component address is one part of the physical address, which is used when sending a message through a loop to the component. See *physical address*.

**configuration:** In the 3600 system, the group of terminals and controller storage areas and application programs that constitute a subsystem associated with a controller.

**configuration image:** A combination of formatted configuration data with selected modules of controller data that, when loaded into the controller storage, determines the operations of the controller.

**continuous forms:** A series of connected forms that feed themselves continuously through a printer. The connections between the forms are perforated to allow the user to tear them apart. Before printing, the forms are folded in a stacked arrangement, with the folds along the perforations. Contrast with *cut form* and *journal roll*.

**controller log:** In a controller, a temporary file on the diskette in which controller log messages are recorded and in which user data can also be recorded.

**control operator:** An operator trained to handle special jobs related to a controller.

**control operator 3604:** A special 3604 assigned to the control operator.

**cursor:** On the 3604 display, a movable short line (underscore) used to indicate the position at which the next operation (for example, insertion, replacement, or deletion of a character) is to take place.

**cut form:** A single preprinted form, such as a deposit slip, money order, or teller check. The form may have more than one part; that is, it may have an original and one or more copies. Contrast with *continuous forms* and *journal roll*.

## D

**debug:** To find and fix errors in a program.

**digit:** One of the numeric characters 0 through 9.

**diskette:** A small, flexible, phonograph-record-like, magnetic disk which is used as an auxiliary storage medium in a controller. The diskette is packaged in a sealed paper envelope that must remain on the diskette during its use.

**displacement:** In controller programmable storage, a number of bytes from the beginning of a segment. It is normally used to indicate the beginning of a field.

**display:** (1) A component that provides visual communication between the user and the controller. (2) A visual presentation of data.

**dual-forms feed:** For the 3618 printer, a mechanism by which two separate forms are moved into the printer, so that the printer has the ability to print on both forms concurrently.

**dump:** With reference to the controller, to copy a part of storage onto a diskette.

## F

**function key:** A key on the 3604 to which the institution can assign any meaning that causes a predetermined action to occur, such as identifying a transaction.

## G

**global storage:** In a controller, programmable storage that is available to all work stations. Contrast with *private storage* and *shared storage*.

## H

**hexadecimal:** A number system with a base of 16.

**host computer:** In discussions of the 3600 system, the term refers to the central computing system that contains the programs that process data transmitted from the controllers, and that contains the data base used to process the requests received from the controllers.

## I

**ID:** Identification

**ID card:** A card, similar in size to a credit card, that contains the user's identification written on a magnetic stripe.

**ID keys:** Specially designated keys on shared terminals that identify the user to the controller.

**inquiry:** A request for information from storage.

**institution:** Any financial establishment, such as a commercial bank, mutual savings bank, savings and loan association, credit unit, and finance company.

**integrated modem:** A modem built into a controller and a 3604 model 2, 3, or 4 or any 3614 model to connect a remote subloop to the controller. The 3604 or 3614 that has the modem must be the first terminal on a remote subloop. (Note: *It is also possible to use an external modem in lieu of the integrated one.*)

## J

**journal roll:** For a 3610 or 3612 printer, a roll of paper that is friction-fed into the printer. Contrast with *cut form* and *continuous forms*.

## L

**local control operator:** A control operator at a local location. Contrast with *remote control operator*.

**local location:** A location that has a controller. Contrast with *remote location*.

**local loop:** In the 3600 system, a closed circuit of cables (not telephone lines) that starts at a controller and attaches terminals one to another and back to the controller. Messages from the controller travel around the loop in one direction. Contrast with *remote loop*.

**log:** See *controller log*.

**log off:** The steps by which a user signs off from the system.

**log on:** The steps by which a user signs on to the system.

**logical device address (LDA):** A number used in the 3600 system to designate a particular terminal component within a work station. Configuration data in the controller correlates the logical device address with the actual physical address. See *physical address*.

**loop:** See *local loop or remote loop*.

**loop number:** In the 3600 system, a number that identifies a particular loop in a controller. See *physical address*.

## M

**magnetic stripe:** The stripe on certain credit cards, ID cards, and passbooks on which data can be recorded magnetically.

**magnetic stripe encoder/reader:** A component available for the 3604 that reads precoded information from, and writes coded information on, a magnetic stripe on a passbook, credit card, or ID card.

**magnetic stripe reader:** A component available for the 3604 that reads precoded information from a magnetic stripe on a passbook, credit card, or ID card.

**modem:** A signal-conversion device or circuitry that is located at each end of a telephone line. At a transmitting location, the modem converts data bits to signals suitable for transmission over the telephone line. At a receiving location, it converts the transmitted signals back to data bits.

**modem unit:** A terminal (3604-2, -3, or -4 and any 3614 model) that has a modem or can be attached to an external modem.

**motor bar:** On some 3604 keyboards, a key that physically takes the place of three regular keys, but is referred to by one scan code.



## N

**numeric character:** Same as digit.

## O

**offline:** Refers to the controller and terminals when they are not communicating with the host computer. Contrast with *online*.

**online:** (1) Refers to the controller and terminals when they are communicating with the host computer. (2) Refers to a user's ability to interact with the computer. Contrast with *offline*.

**operating diskette:** A diskette used in a controller that contains the configuration image, and other data, relating to the operation of the controller. The operating diskette must be in the controller during its operations. A second diskette containing the same configuration image and data is referred to as a *backup operating diskette*. Contrast with *starter diskette*.

**operator A:** In the 3600 system, one of two operators who can share a terminal. Operator identification is achieved by pressing a key at the terminal. See *user-shared terminal*.

**operator B:** In the 3600 system, one of two operators who can share a terminal. Operator identification is achieved by pressing a key at the terminal. See *user-shared terminal*.

## P

**parameter:** A variable that is given a fixed value for a specific application. See *parameter data byte* and *parameter flag byte*.

**parameter data byte:** When setting up or changing the parameters of a terminal component, the data bytes give values to the various parameters. See *parameter flag byte*.

**parameter flag byte:** When setting up or changing the parameters of a terminal component that can operate with different groups of parameters, the flag byte specifies which group of parameters are being set up or changed by the parameter data bytes. See *parameter data byte*.

**permanent file:** In the 3600 system, a file on a diskette that can be used to store data to be retained from one controller startup to another. The permanent data might include such things as day-to-day totals or checkpoint/restart data. Contrast with *temporary file*.

**physical address:** In the 3600 system, an address that is used to reach a particular terminal or component. A physical address consists of a loop number, a terminal address, and a component address. In the configuration image in a controller, each physical address is correlated with a number (called a logical device address) that is used to identify a component in a work station. See *logical device address*.

**private storage:** In the controller, programmable storage that is associated with only one work station. Contrast with *global storage* and *shared storage*.

**programmable storage:** The portion of internal storage in the controller in which user-written programs are executed.

**prompt:** To help a terminal user by displaying messages that request her to enter information necessary to continue an operation.

## R

**record:** Pertains to the classification of data stored on a diskette.

**remote control operator:** A control operator at a remote branch. Contrast with *local control operator*.

**remote location:** A location that is connected to the controller by a communication link. Contrast with *local location*.

**remote loop:** In the 3600 system, a closed circuit of telephone lines (not local cables) that starts at a controller and attaches remote locations one to another and back to the controller. Messages from the controller travel around the loop in one direction. Contrast with *local loop*.

**remote subloop:** In a remote loop, the closed circuit of cables that attach the remote terminals to each other at a remote location. See *remote loop*.

**repeat-action key:** A key that, when held fully depressed, causes an action (such as the typing of a character) to be repeated until the key is released.

## S

**scan code:** A one-byte hexadecimal value that identifies a terminal key.

**segment:** In a controller, one of 16 portions into which the programmable storage related to a controller application program can be divided. The length of each segment is specified by the user.

**shared storage:** In the controller, programmable storage that is reserved for the application program and which may be shared between work stations. Contrast with *global storage* and *private storage*.

**special character:** Refers to any character other than the 26 letters and the 10 digits; for example, punctuation marks.

**SR:** Service Representative.

**starter diskette:** A diskette used in a controller mainly to initiate communication with the host computer and to prepare the controller for reception and recording of the configuration image. Contrast with *operating diskette*.

**step:** A fractional part of a print line on a passbook. There are 12 steps to a line.

**storage:** A part of the controller or host computer in which the program or data is kept.

**subloop:** See *remote subloop*.

**system monitor:** The facility in a controller that handles communications with the control operator.

## T

**temporary file:** In the 3600 system, a file on a diskette that can be used to store data that is not to be retained from one controller startup to another. This temporary data might include such things as a daily audit trail or a teller's cash position. Contrast with *permanent file*.

**terminal:** One of the 3600 units that is used by operators to enter information into the system or to receive information from the system.

**terminal address:** In the 3600 system, the address of a particular terminal or terminal group on a loop, established at each terminal by setting address switches on the terminal itself. The terminal address is part of the physical address. See *physical address*.

**terminal component:** A separately addressable part of a terminal; the component performs an input or an output function, but usually not both.

**terminal group:** a group of terminals sharing a common terminal address on a loop.

**terminal pool:** A pool of terminals that are attached to a controller, but are not assigned to work stations.

**test component:** A terminal component that will be tested by keyboard commands.

**track:** In the controller, the portion of the diskette that is accessible to a given position of the disk drive read/write head.

**transaction:** (1) In the 3600 system, generally, an exchange between a terminal and another unit to effect a particular action or result. (2) More specifically, a single communication action involving an inquiry from a terminal that produces a response containing desired information (such as a request from a terminal for a customer's account balance) or a more complex action in which data records must be changed (such as a request to update a customer's balance with a new deposit).

## U

**universal translation table:** The controller translation table used with the 3604 keyboard when operating with the system monitor.

**user-shared terminal:** A terminal that is shared by two operators.

## W

**warm start:** A startup of the controller that does not erase the data in the diskette temporary files. Contrast with *cold start*.

**warning line:** The line number of any physical print line on a form used in a printer. The warning line indicates the specified end of the form is near.

**work station:** In the 3600 system, a collection of terminals and storage that is used by an application program executed by a controller to process transactions.

**wrap test** (for an external modem or integrated 1200-bps remote loop):  
At a local location, a test performed by the controller that checks the controller and its modem that connects to the remote loop. At a 1200-bps remote location or a location with an external modem, a test that checks the remote subloop and its modem. (Note: *Some external modem models cannot be wrap-tested; the wrap test is then valid for only the controller or terminal.*)

Place all Index pages after this tab.

## Index

*Item*

address switches  
alternative sector(s), assigning  
analysis, disk file surface  
application program modification  
application programs  
assign alternative sector(s)  
basic commands  
binary numbers  
central site connections  
clearing the initial tracks  
commands  
    basic  
    complete  
communicating with the controller  
complete commands  
component testing  
configurations  
controller  
    general  
    log, display/print  
    storage  
counters, display/print statistical  
create diskette  
diskette  
    create  
    formatting  
    transmit  
diskette and disk storage  
display/print  
    controller log  
    statistical counters  
debug mode  
decimal numbers  
error recovery procedures  
    disk file  
    system  
external modem procedures, problem recovery  
failing sector(s), locate  
Financial Services Terminals  
formatting, diskette  
general control operator information  
glossary  
hexadecimal numbers  
initial tracks, clearing  
installation reference sheets

*See listing following tab noted below*

Installation Details  
System Operating Procedures  
System Operating Procedures  
System Operating Procedures  
Introduction  
System Operating Procedures  
General Operating Procedures  
Number Systems and Glossary  
Introduction  
System Operating Procedures  
General Operating Procedures  
System Operating Procedures  
System Operating Procedures  
System Operating Procedures  
General Operating Procedures  
Introduction  
Introduction, Unit Operating Procedures  
System Operating Procedures  
Introduction  
System Operating Procedures  
System Operating Procedures  
System Operating Procedures  
System Operating Procedures  
Introduction  
System Operating Procedures  
System Operating Procedures  
System Operating Procedures  
System Operating Procedures  
Number Systems and Glossary  
System Operating Procedures  
Problem Recovery  
Problem Recovery  
System Operating Procedures  
Unit Operating Procedures  
System Operating Procedures  
System Operating Procedures  
Number Systems and Glossary  
Number Systems and Glossary  
System Operating Procedures  
Installation Details

This page follows the Index tab.

## Index (cont)

| <i>Item</i>                                   | <i>See listing following tab noted below</i> |
|---|--|
| integrated modem procedures, problem recovery | Problem Recovery                             |
| introduction                                  | Introduction                                 |
| keyboard/displays                             | Unit Operating Procedures                    |
| line units                                    | Unit Operating Procedures                    |
| local location procedures, problem recovery   | Problem Recovery                             |
| local loops                                   | Introduction                                 |
| locate flagged sector(s)                      | System Operating Procedures                  |
| log messages                                  | System Operating Procedures                  |
| logoff  | General Operating Procedures                 |
| logon   | General Operating Procedures                 |
| loop speed and address switches               | Installation Details                         |
| Loop Repeater                                 | Unit Operating Procedures                    |
| messages                                      |  |
| log   | System Operating Procedures                  |
| system  | General Operating Procedures                 |
| moving the system track                       | System Operating Procedures                  |
| number systems                                | Number Systems and Glossary                  |
| print   |  |
| controller log                                | System Operating Procedures                  |
| statistical counters                          | System Operating Procedures                  |
| printers                                      | Unit Operating Procedures                    |
| problem recovery                              |  |
| disk file                                     | System Operating Procedures                  |
| index   | Problem Recovery                             |
| procedures                                    | Problem Recovery                             |
| problem report sheets                         | Problem Recovery                             |
| programmable storage                          | Introduction                                 |
| program modification, application             | System Operating Procedures                  |
| reformatting sector(s)                        | System Operating Procedures                  |
| remote location procedures, problem recovery  | Problem Recovery                             |
| remote loops                                  | Introduction                                 |
| sector(s)                                     |  |
| assign alternative                            | System Operating Procedures                  |
| locate failing IDs                            | System Operating Procedures                  |
| reformatting                                  | System Operating Procedures                  |
| startup errors                                | General Operating Procedures                 |
| startup, logon, and logoff                    | General Operating Procedures                 |
| statistical counters, display/print           | System Operating Procedures                  |
| storage                                       | Introduction                                 |
| system configurations                         | Introduction                                 |
| system monitor                                | System Operating Procedures                  |
| system track, moving                          | System Operating Procedures                  |
| supplies                                      | Installation Details                         |
| surface analysis, disk file                   | System Operating Procedures                  |
| switches                                      |  |
| address                                       | Installation Details                         |
| loop speed                                    | Installation Details                         |

**Index (cont)**

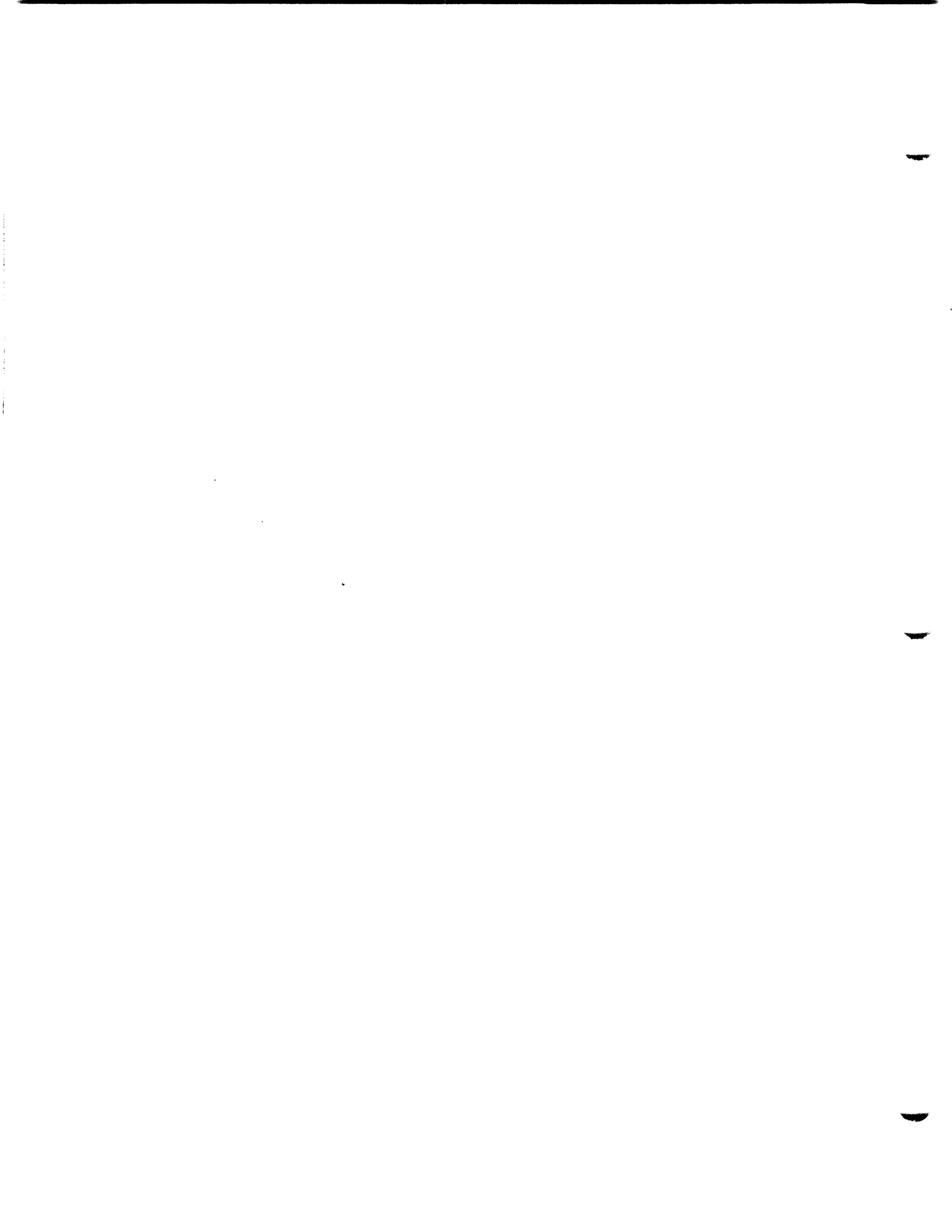
*Item*

*See listing following tab noted below*

terminal addressing  
terminals  
testing, component  
translation tables  
transmit diskette  
TTRR identification  
universal translation table  
work station  
3600 system terminals

Introduction  
Introduction, Unit Operating Procedures  
General Operating Procedures  
Introduction, System Operating Procedures  
System Operating Procedures  
System Operating Procedures  
System Operating Procedures  
Introduction  
Introduction, Unit Operating Procedures





3600 Finance Communication System  
Operating Guide

**READER'S  
COMMENT  
FORM**

Order No. GA27-2776-5

*Your views about this publication may help improve its usefulness; this form will be sent to the author's department for appropriate action. Using this form to request system assistance or additional publications will delay response, however. For more direct handling of such request, please contact your IBM representative or the IBM Branch Office serving your locality.*

Possible topics for comment are:

Clarity    Accuracy    Completeness    Organization    Index    Figures    Examples    Legibility

Cut or Fold Along Line

What is your occupation? \_\_\_\_\_

Number of latest Technical Newsletter (if any) concerning this publication: \_\_\_\_\_

Please indicate if you wish a reply.                       Yes                       No

If yes:    Name    \_\_\_\_\_

\_\_\_\_\_

Address \_\_\_\_\_

Thank you for your cooperation. No postage stamp necessary if mailed in the U.S.A. (Elsewhere, an IBM office or representative will be happy to forward your comments.)

**Your comments, please . . .**

Your comments, together with your answer to the questions on the back of this form will help us produce better publications for your use. Your comments will be carefully reviewed by the persons responsible for writing and publishing this material. All comments and suggestions become the property of IBM.

Cut or Fold Along Line

Fold

Fold

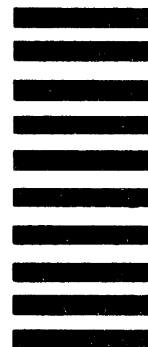
First Class  
Permit 40  
Armonk  
New York

**Business Reply Mail**

No postage stamp necessary if mailed in the U.S.A.

Postage will be paid by:

International Business Machines Corporation  
Department 63T  
Neighborhood Road  
Kingston, New York 12401



Fold

Fold



**International Business Machines Corporation  
Data Processing Division  
1133 Westchester Avenue, White Plains, New York 10604  
(U.S.A. only)**

**IBM World Trade Corporation  
821 United Nations Plaza, New York, New York 10017  
(International)**





**International Business Machines Corporation**  
**Data Processing Division**  
**1133 Westchester Avenue, White Plains, New York 10604**  
**(U.S.A. only)**

**IBM World Trade Corporation**  
**821 United Nations Plaza, New York, New York 10017**  
**(International)**