

EmbeddedDNA[®]

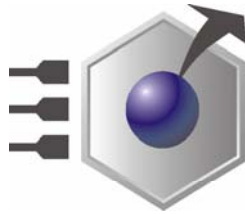

EuroTech
THE COMPLETE EMBEDDED PC SOLUTION

An0030

CPU-1432; TFT Digital Interface

Rev. 1.0

Sep. 2003

COPYRIGHT 1994-2005 Eurotech S.p.A. All Rights Reserved.

ABOUT THIS MANUAL

This application note contains information about the TFT Digital Interface installed on the CPU-1432.



Via J. Linussio 1
33020 AMARO (UD)
ITALY

Phone: +39 0433 485 411
Fax: +39 0433 485 499

web: <http://www.eurotech.it>
e-mail: <mailto:sales@eurotech.it>



NOTICE

Although all the information contained herein has been carefully verified, Eurotech S.p.A. assumes no responsibility for errors that might appear in this document, or for damage to property or persons resulting from an improper use of this manual and of the related software. Eurotech S.p.A. reserves the right to change the contents and form of this document, as well as the features and specifications of its products at any time, without notice.

Trademarks and registered trademarks appearing in this document are the property of their respective owners

Conventions

The following table lists conventions used throughout this guide.

Icon	Notice Type	Description
	Information note	Important features or instructions
	Warning	Information to alert you to potential damage to a program, system or device or potential personal injury

(This page is intentionally left blank.)

Table of Contents

Conventions	3
Table of Contents	5
Chapter 1 CPU-1432 TFT Digital Interface	7
TFT Digital Interface Overview	7
J4 TFT Digital Interface Connector	8
J4 TFT Digital Interface Pin Out.....	9
J4 TFT Digital Interface signal description	10
Chapter 2 BIOS Setup	11
CPU-1432 BIOS Menu.....	11
CPU-1432 BIOS Flat Panel parameters	12
Defining CPU-1432 BIOS parameters	12
Timings Diagrams	14
Chapter 3 Connecting the TFT-LCD to the CPU-1432.....	16

(This page is intentionally left blank.)

Chapter 1 CPU-1432 TFT Digital Interface

This brief application note contains information about using the CPU-1432 TFT digital interface. The goal is to help users properly connect TFT-LCD panels to the CPU-1432.

TFT Digital Interface Overview

The CPU-1432 allows you to connect various models of LCD-TFT panels via its J4 connector. The following table shows the supported LCD-TFT video resolutions

Resolution	Simultaneous Colours	Refresh Rate (Hz)
640x480	8bpp 256 colours	60
640x480	16bpp 64K colours	60
800x600	8bpp 256 colours	60
800x600	16bpp 64K colours	60
1024x768	8bpp 256 colours	60
1024x768	16bpp 64K colours	60

Table 1. LCD-TFT video resolutions (*)

(*)- This list is not meant to be a complete list of all the possible supported TFT video

For further info about other/new supported LCD-TFT flat panels, please contact the Eurotech Customer Support Service.

J4 TFT Digital Interface Connector

The TFT digital interface is accessible via the J4 connector, which is a 20x2 pitch 1.25mm SMT connector.

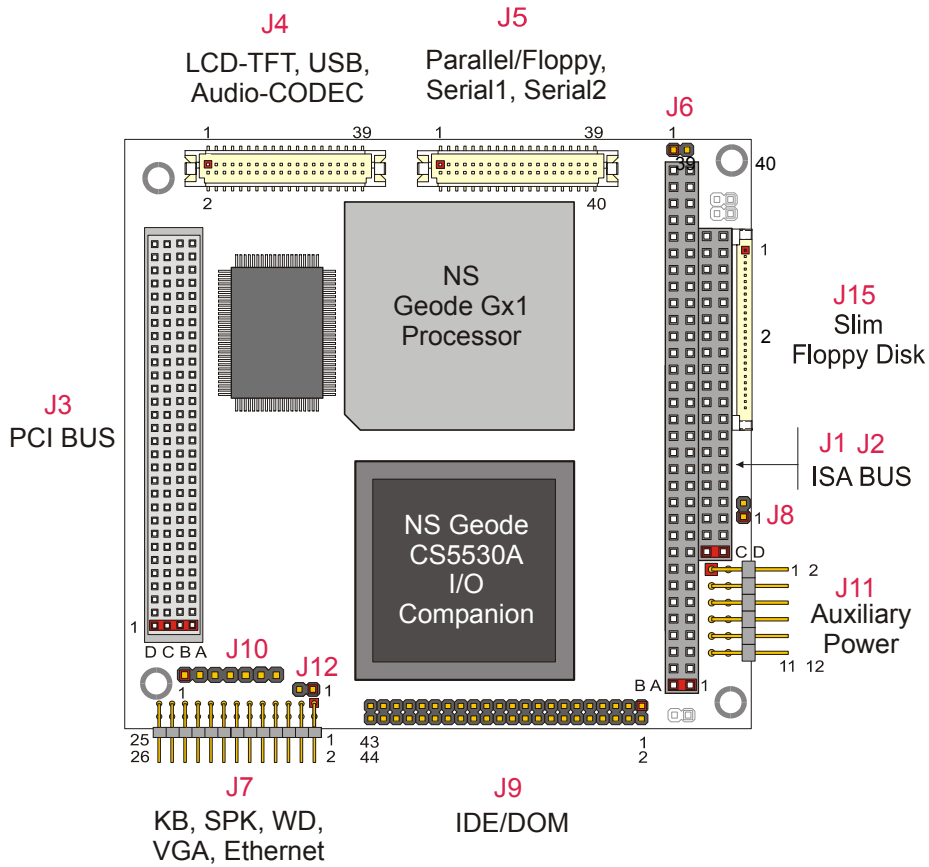

Figure 1. Connectors layout

The following table shows the J4 connector type and its matching models:

Connector Reference	Connector Type
J4 Used Connector	Hirose DF13-40DP-1.25V
J4 Corresponding connector	Hirose DF13-40DS-1.25C

Table 2. J4 mating connectors

For further information about connectors (electrical, mechanical, ...), please refer to the Hirose website (<http://www.hirose.com/>) referring to the DF13 connector family.

J4 TFT Digital Interface Pin Out

The following table describes the signals of the J4 TFT Digital Interface connector:

PIN	SIGNAL	SIGNAL	PIN	FUNCTION	
1	GND	Dot Clock	2	LCD-TFT	
3	GND	RED5 (MSB)	4		
5	Data Enable	RED4	6		
7	RED3	RED2	8		
9	RED1	RED0 (LSB)	10		
11	BLUE5 (MSB)	VDD Enable	12		
13	BLUE4	BLUE3	14		
15	BLUE2	BLUE1	16		
17	BLUE0 (LSB)	GREEN5 (MSB)	18		
19	Back Light enable	GREEN4	20		
21	GREEN3	GREEN2	22		
23	GREEN1	GREEN0 (LSB)	24		
25	FP_VSYNC	FP_HSYNC	26		
27	GND_USB	USBDP	28		USB
29	USB DN	VDD_USB	30		
31	PC_BEEP	VDD_CODEC	32		
33	SDATA_OUT	RSTDRV	34		AUDIO-CODEC
35	SDATA_IN	SYNC	36		
37	GND1_CODEC	AC97_CLK	38		
39	GND2_CODEC	BITCLK	40		

Table 3. J4 TFT Digital Interface connector pinout

For further information about the physical layout of the J4 connector please refer to the Figure 1 layout.

This information is intended to help the user properly build the cable used to connect the Digital interface of the CPU-1432 with the TFT LCD panel selected.

Reducing the cable length can allow users to reduce possible interference to the TFT LCD digital signals.

J4 TFT Digital Interface signal description

The digital TFT interface signals are described in the following table:

SIGNAL NAME	Description	Electrical Characteristics
Dot Clock	Pixel Port Clock Dot Clock is the pixel dot clock output. It clocks the pixel data.	TTL 8mA $V_{HMAX} = 3.3V$
FP_HSYNC	Flat Panel Horizontal Sync Flat Panel Horizontal Sync establishes the line rate and horizontal Retrace interval for a TFT display.	TTL 8mA $V_{HMAX} = 3.3V$
FP_VSYNC	Flat Panel Vertical Sync Flat Panel Vertical Sync establishes the screen refresh rate and vertical retrace interval for a TFT display.	TTL 8mA $V_{HMAX} = 3.3V$
ENA_DISP	Display Enable Display Enable indicates the active display portion of a scan line.	TTL 8mA $V_{HMAX} = 3.3V$
VDD ENABLE		TTL 8mA $V_{HMAX} = 3.3V$
DATA ENABLE	This is a data valid signal	TTL 8mA $V_{HMAX} = 3.3V$
BACKLIGHT ENABLE	This is a useful signal which allow you to control the switching on-off of the lamps	TTL 8mA $V_{HMAX} = 3.3V$
RED[5:0]	Graphics Red Pixel Data Bus This bus drives graphics pixel data synchronous to the Dot Clock output.	TTL 8mA $V_{HMAX} = 3.3V$
GREEN[5:0]	Graphics Green Pixel Data Bus This bus drives graphics pixel data synchronous to the Dot Clock output.	TTL 8mA $V_{HMAX} = 3.3V$
BLUE[5:0]	Graphics Blue Pixel Data Bus This bus drives graphics pixel data synchronous to the Dot Clock output.	TTL 8mA $V_{HMAX} = 3.3V$
GND	Ground	Ground

Table 4. Signal Description - Electrical Characteristics

Chapter 2 BIOS Setup

To enable the TFT Digital Interface functionality, the user should properly configure the BIOS settings. This section illustrates the BIOS settings the user is allowed to modify for properly controlling the LCD-TFT. For further information on how to use the BIOS functionality, please refer to the CPU-1432 user manual.

CPU-1432 BIOS Menu

After entering BIOS setup by pressing the F2 Key during the boot time, select the Flat Panel menu using cursors. You will be prompted to the following menu:

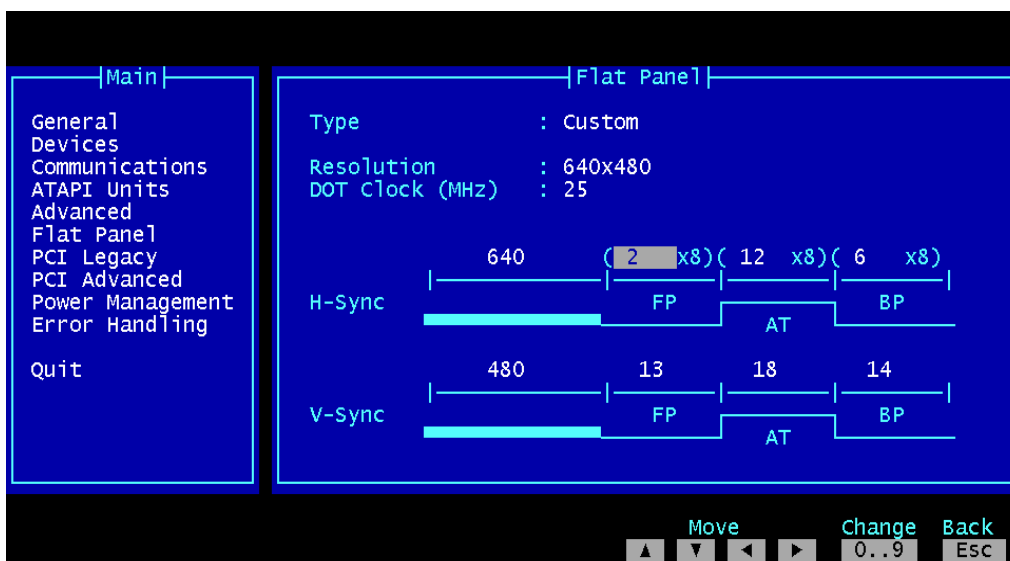

Figure 2. BIOS setup - Flat Panel section

CPU-1432 BIOS Flat Panel parameters

Here a brief description of each field the user is allowed to modify from the BIOS setup program and its default value:

Field	Description		Default Value
Type	Disabled	Disabled	Disabled
	Custom	Custom parameters	
	Hitachi 800x600 (38MHz)		
	LG 800x600 (38MHz)		
	NEC 800x600 (38MHz)		
	Sharp 800x600 (40MHz)		
Resolution	640x480	Select the proper graphical resolution	640x480
	800x600		
	1024x768		
Dot Clock (MHz)	Dot Clock Frequency in MHz		0
HSync FP	Front Porch - Horizontal Sync		0
HSync AT	Active Time - Horizontal Sync		0
HSync BP	Back Porch - Horizontal Sync		0
VSyn FP	Front Porch - Vertical Sync		0
VSyn AT	Active Time - Vertical Sync		0
VSyn BP	Back Porch - Vertical Sync		0

Table 5. BIOS Flat Panel Section Options

To properly enter the parameters, the user should analyze the information contained in the TFT-LCD datasheet that the user wishes to connect to the CPU-1432 and insert the data for the various fields.

Sometimes, if connecting both a CRT and TFT-LCD devices, the image shown on the CRT is rescaled and shifted because the parameters for the TFT interface modify the video settings.

Defining CPU-1432 BIOS parameters

To enter the proper parameters into the Flat Panel BIOS settings, refer to the TFT-LCD datasheet. Table 6 shows an example of a timing table referring to a 640x480 TFT-LCD.

Parameter		Symbol	Min.	Typ.	Max.	Unit	Remarks
CLK	Frequency	1/fo	21.0	25.175	29.0	MHz	39.722 ns (Typ.)
	Duty	tch/fo	0.4	0.5	0.6	–	–
	Rise, fall	torf	–	–	10	ns	–
Hsync	Period	th	30.0	31.778	33.6	μs	31.469 kHz (Typ.)
			–	800	–	CLK	
	Display period	thd	640			CLK	–
	Front-porch	thf	16			CLK	Fixed timing mode
			2	16	–	CLK	DE mode
	Pulse width	thp*	10	96	–	CLK	Fixed timing mode
			10	96	–	CLK	DE mode
	Back-porch	thb*	4	48	–	CLK	Fixed timing mode
			4	48	–	CLK	DE mode
	thp + thb*		144			CLK	Fixed timing mode
			14	144	–	CLK	DE mode
	CLK-Hsync timing	thch	12	–	–	ns	–
	Hsync-CLK timing	thcs	8	–	–	ns	–
	Hsync-Vsync timing	tvh	1	–	–	CLK	1CLK = 39.722 ns (Typ.)
Vsync-Hsync timing	tvh	30	–	–	ns	–	
Rise, fall	thrf	–	–	10	ns	–	
Vsync	Period	tv	16.1	16.683	17.2	ms	59.94 Hz (Typ.)
			–	525	–	H	
	Display period	tvd	480			H	–
	Front-porch	tvf	12			H	Fixed timing mode
			1	12	–	H	DE mode
	Pulse width	tvp*	1	2	–	H	Fixed timing mode
			1	2	–	H	DE mode
	Back-porch	tvb*	4	31	–	H	Fixed timing mode
			4	31	–	H	DE mode
	tvp + tvb*		33			H	Fixed timing mode
5			33	–	H	DE mode	
Rise, fall		–	–	10	ns	–	
DATA R0 - R5 G0 - G5 B0 - B5	CLK-DATA timing	tds	8	–	–	ns	–
	DATA-CLK timing	tdh	12	–	–	ns	–
	Rise, fall	tdrf	–	–	10	ns	–
DE	DE-CLK timing	tes	8	–	–	ns	DE mode
	CLK-DE timing	teh	12	–	–	ns	
	Rise, fall	terf	–	–	10	ns	

Table 6. Timing Characteristic Example for a TFT-LCD

The following instructions are an example showing how to define the values to enter into the Flat Panel BIOS setup according to the timing characteristics in Table 6.

BIOS Field	BIOS Value	Notes
Type	Custom	We would enter custom parameters
Resolution	640x480	Obtained from the TFT-LCD Data Sheet, this is a characteristic.
Dot Clock (MHz)	25	Referring Table 6 CLK (1/Tc) Typical value. The reported value 25.175MHz is approximated to 25Mhz
HSync FP	2	Referring Table 6 HSync Front Porch (thf) Typical value. The reported value 16CLK. So the value you've to enter the BIOS is 2 to obtain $16 = (2 \times 8)$
HSync AT	12	Referring Table 6 HSync Pulse width (thp*) Typical value. The reported value 96CLK. The value you've to enter the BIOS is 12 to obtain $96 = (12 \times 8)$
HSync BP	6	Referring Table 6 HSync Pulse Back-porch (thb*) Typical value. The reported value 48CLK. The value you've to enter the BIOS is 6 to obtain $48 = (6 \times 8)$
VSsync FP	12	Referring Table 6 VSsync Front Porch (tvf) Typical value. The reported value 12CLK.
VSsync AT	2	Referring Table 6 VSsync Pulse width (tvp*) Typical value. The reported value 2 H.
VSsync BP	31	Referring Table 6 VSsync Back Porch (thb*) Typical value. The reported value 31CLK.

Table 7. Flat Panel BIOS parameters

Timings Diagrams

The followings images show a graphical mode to represent timing data. The information is not represented in the same graphical order shown into the Flat Panel BIOS setup, but the contents are the same.

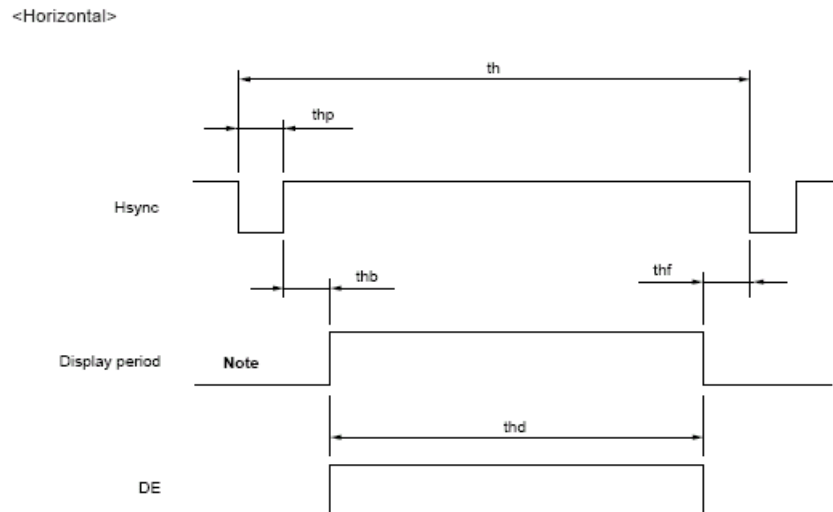

Figure 3. Timing Diagram Horizontal Mode

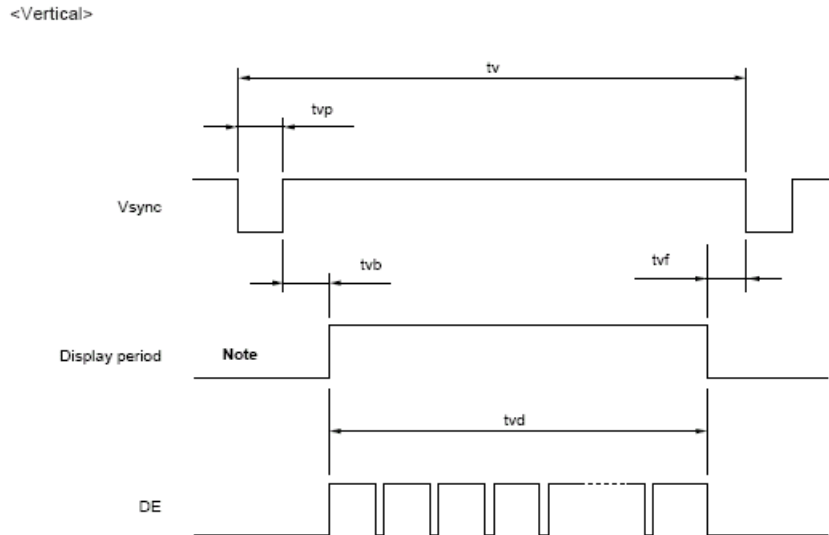

Figure 4. Timing Diagram Vertical Mode

The previous figures may be useful to graphically verify if the entered BIOS parameters match the TFT timing diagram.

Regarding the timing, the following relationships should be ensured:

Horizontal Sync. :

Period (th) = Display Period (thd) + Front Porch (thf) + Pulse Width (thp*) + Back Porch (thb*)

Vertical Sync. :

Period (tv) = Display Period (tvd) + Front Porch (tvf) + Pulse Width (tvp*) + Back Porch (tvb*)

Practically, referring to Table 6 and to Table 7, the results are:

Horizontal Sync : $800 = 640 + 16 + 96 + 48$

Vertical Sync : $525 = 480 + 12 + 31 + 2$

Chapter 3 Connecting the TFT-LCD to the CPU-1432

This section contains a brief checklist of the actions to perform before connecting a TFT-LCD to the CPU-1432.

- ❑ Download all information about the TFT-LCD module and its inverter selected;
- ❑ Verify that the resolution of the TFT panel is compatible with and supported by the resolution shown in Table 1 of this Application note;
- ❑ Read carefully the TFT-LCD datasheet, in particular the Electrical Characteristics that must be compatible with the electrical interface of the CPU-1432 TFT LCD interface referred to in Table 4;
- ❑ Consulting the TFT-LCD datasheet and the Table 3 CPU-1432 connector pin-out, write a table with the connections between the J19 CPU-1432 connector and the TFT-LCD selected; this may be useful when building the connection cable;
- ❑ Consulting the TFT-LCD inverter datasheet and Table 3 CPU-1432 connector pin-out, make the proper cable.
- ❑ Refer to the TFT-LCD input signal timing datasheet section to detect the parameters to insert into the CPU-1432 BIOS Flat Panel section and calculate it as described in the Chapter 2 BIOS Setup.
- ❑ To connect the system, carefully verify the connections cable, the BIOS settings and all the information to prevent erroneous damages to the system.
- ❑ After you've verified the information, power up the system verifying all information is properly displayed on the TFT-LCD module. Try some graphical test programs to detect the functionality of the images.